



**SPEAR &  
JACKSON**

# ORIGINAL INSTRUCTION MANUAL

18V

## Cordless Pole Saw

NOF-GT-250/18-D



**Important - Please read these instructions  
fully before starting assembly**

These instructions contain important information that will help you get the best from your pole saw, ensuring it is assembled correctly and safely. If you need help or have damaged or missing parts, call the Customer Helpline on 0345 605 2067

**AFTER SALES SUPPORT  
0345 605 2067**

# SPEAR & JACKSON SINCE 1760

---

For more than 250 years gardeners have enjoyed high quality performance and great results using Spear & Jackson tools.

Our garden power tools combine continuous innovation and the latest in manufacturing technologies with a proud heritage.

Each product is carefully designed with performance, comfort and durability firmly in mind, which has earned Spear & Jackson an enviable reputation as a maker of tools to trust.

## 3 YEARS GUARANTEE

As a testament to the quality of our products, we offer a 3 year manufacturers warranty and a comprehensive after sales service.

The warranty covers manufacturing faults, however in the event that the item has been deliberately damaged, used in a commercial environment or disassembled then the warranty will be null and void.

Please retain proof of purchase.

## 7 DAYS A WEEK TECHNICAL SUPPORT

We want you to get the best out of your products. Our easy-to-read instruction manual guides you with best practice use and maintenance tips. Please call **0345 605 2067** for technical support, we can solve around 80% of questions directly over the phone.

We hope you enjoy your product and we look forward to any feedback, as this allows us to develop even better products for the future.

# CONTENTS

<b>Safety Information</b> .....	<b>04</b>
Description of symbols .....	04
Warning symbols on the charger .....	05
Warning symbols on the battery pack .....	05
General safety .....	06
Additional safety instructions for batteries and chargers .....	10
Additional safety instructions for pole saw .....	14
Training .....	17
Prepare .....	17
Operate .....	18
Intended use .....	18
<b>Box Content / Parts</b> .....	<b>19</b>
<b>Assemble</b> .....	<b>20</b>
Unpacking .....	20
Assemble the front handle.....	20
Assemble the shoulder strapper.....	21
Fill lubrication oil.....	21
Charging the battery .....	22
Check battery capacity .....	24
<b>Operate</b> .....	<b>25</b>
Telescopic handle adjustment.....	25
Install battery pack.....	25
Remove the battery from product.....	25
Switching on/off.....	26
Check the oil supply.....	26
Chain tension.....	27
Pruning.....	28
Pull sawing .....	28
Push sawing.....	29
Tree cutting.....	29
<b>Maintenance</b> .....	<b>30</b>
<b>Troubleshooting</b> .....	<b>36</b>
<b>Technical Data</b> .....	<b>37</b>
<b>Warranty</b> .....	<b>39</b>

# SAFETY INFORMATION

Please read these instructions fully before operating or maintaining your machine

## DESCRIPTION OF SYMBOLS

The following warning symbols appear throughout this manual and indicate the appropriate safety measures you should take when operating and maintaining the pole saw.



Read instruction handbook before operating this machine.



### WARNING!

This is a warning symbol. This symbol is used throughout the user guide whenever there is a risk of personal injury. Ensure that these warnings are read and understood at all times.



**This symbol indicates the requirement of wearing ear.**



**Protection and eye protection when using the product.**



**Wear safety helmet**



**Wear protection gloves**



**Wear proper safety shoes.**



Keep bystanders away.  
Thrown objects can cause serious injury



Disconnect the battery pack before any repair or maintenance.



Guaranteed sound power level in 93dB.



Do not expose and operate the tool in rain.



Risk of fatal electric shock. At least 10m distance from overhead lines to keep.



Keep all bystanders at least 50 ft.(15m) away.



**DANGER!** Beware of kickback.



Waste electrical products should not be disposed of with household waste. Please recycle where facilities exist. Check your Local Authority or retailer for recycling advice.



The product complies with the applicable European directives and an evaluation method of conformity for these directives was done.

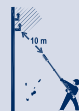

**Warning!** The device is not protected against electric shocks when it touches high-voltage lines! Maintain a safe distance of 10m from live electrical lines.

# SAFETY INFORMATION

Please read these instructions fully before operating or maintaining your machine

## WARNING SYMBOLS ON THE CHARGER



Read instruction handbook before operating this machine.



The charger is for indoor use only.



Double insulation.



Pole orientation.



Waste electrical products should not be disposed of with household waste. Please recycle where facilities exist. Check your Local Authority or retailer for recycling advice.

## WARNING SYMBOLS ON THE BATTERY PACK



li-ion

Batteries contain Li-ion, waste batteries should be sorted for eco-friendly. Do not dispose of waste batteries as unsorted municipal waste.



Do not dispose of batteries in rivers or immerse in water.



Do not litter to fire.



Do not subject the battery to strong sunlight over long periods and do not leave it on a heater (max.45°).



Do not dispose of batteries. Return exhausted batteries to your local collection or recycling point.

# SAFETY INFORMATION

Please read these instructions fully before operating or maintaining your machine

## GENERAL SAFETY

### GENERAL POWER TOOL SAFETY

 **WARNING** Read all safety warnings and all instructions. Failure to follow the warnings and instructions may result in electric shock, fire and/or serious injury.

Save all warnings and instructions for future reference.

The term “power tool” in the warnings refers to your mains-operated (corded) power tool or battery-operated (cordless) power tool.

### Work area safety

- Keep work area clean and well lit. Cluttered or dark areas invite accidents.
- Do not operate power tools in explosive atmospheres, such as in the presence of

flammable liquids, gases or dust. Power tools create sparks which may ignite the dust or fumes.

- Keep children and bystanders away while operating a power tool. Distractions can cause you to lose control.

### Electrical safety

- Power tool plugs must match the outlet. Never modify the plug in any way. Do not use any adapter plugs with earthed (grounded) power tools. Unmodified plugs and matching outlets will reduce risk of electric shock.
- Avoid body contact with earthed or grounded surfaces, such as pipes, radiators, ranges and refrigerators. There is an increased risk of electric shock if your body is earthed or grounded.

# SAFETY INFORMATION

Please read these instructions fully before operating or maintaining your machine

- Do not expose power tools to rain or wet conditions. Water entering a power tool will increase the risk of electric shock.
- Do not abuse the cord. Never use the cord for carrying, pulling or unplugging the power tool. Keep cord away from heat, oil, sharp edges or moving parts. Damaged or entangled cords increase the risk of electric shock.
- When operating a power tool outdoors, use an extension cord suitable for outdoor use. Use of a cord suitable for outdoor use reduces the risk of electric shock.
- If operating a power tool in a damp location is unavoidable, use a residual current device (RCD) protected supply. Use of an RCD reduces the risk of electric shock.

NOTE: The term “residual

current device(RCD)” may be replaced by the term “ground fault circuit interrupter (GFCI)” or “earth leakage circuit breaker(ELCB)”.

## Personal safety

- Stay alert, watch what you are doing and use common sense when operating a power tool. Do not use a power tool while you are tired or under the influence of drugs, alcohol or medication. A moment of inattention while operating power tools may result in serious personal injury.
- Use personal protective equipment. Always wear eye protection. Protective equipment such as dust mask, non-skid safety shoes, hard hat, or hearing protection used for appropriate conditions will reduce personal injuries.

# SAFETY INFORMATION

Please read these instructions fully before operating or maintaining your machine

- Prevent unintentional starting. Ensure the switch is in the off-position before connecting to power source and/or battery pack, picking up or carrying the tool. Carrying power tools with your finger on the switch or energising power tools that have the switch on invites accidents.
- Remove any adjusting key or wrench before turning the power tool on. A wrench or a key left attached to a rotating part of the power tool may result in personal injury.
- Do not overreach. Keep proper footing and balance at all times. This enables better control of the power tool in unexpected situations.
- Dress properly. Do not wear loose clothing or jewellery. Keep your hair, clothing and gloves away from moving parts. Loose clothes, jewellery or long

hair can be caught in moving parts.

- If devices are provided for the connection of dust extraction and collection facilities, ensure these are connected and properly used. Use of dust collection can reduce dust-related hazards.

## Power tool use and care

- Do not force the power tool. Use the correct power tool for your application. The correct power tool will do the job better and safer at the rate for which it was designed.
- Do not use the power tool if the switch does not turn it on and off. Any power tool that cannot be controlled with the switch is dangerous and must be repaired.
- Disconnect the plug from the power source and/or the battery pack from the power tool before



# SAFETY INFORMATION

Please read these instructions fully before operating or maintaining your machine

making any adjustments, changing accessories, or storing power tools. Such preventive safety measures reduce the risk of starting the power tool accidentally.

- Store idle power tools out of the reach of children and do not allow persons unfamiliar with the power tool or these instructions to operate the power tool. Power tools are dangerous in the hands of untrained users.
- Maintain power tools. Check for misalignment or binding of moving parts, breakage of parts and any other condition that may affect the power tool's operation. If damaged, have the power tool repaired before use. Many accidents are caused by poorly maintained power tools.
- Keep cutting tools sharp and clean. Properly maintained cutting tools

with sharp cutting edges are less likely to bind and are easier to control.

- Use the power tool, accessories and tool bits etc. in accordance with these instructions, taking into account the working conditions and the work to be performed. Use of the power tool for operations different from those intended could result in a hazardous situation.

## Battery tool use and care

- Recharge only with the charger specified by the manufacturer. A charger that is suitable for one type of battery pack may create a risk of fire when used with another battery pack.
- Use power tools only with specifically designated battery packs. Use of any other battery packs may create a risk of injury and fire.
- When battery pack is not

# SAFETY INFORMATION

Please read these instructions fully before operating or maintaining your machine

in use, keep it away from other metal objects, like paperclips, coins, keys, nails, screws or other small metal objects, that can make a connection from one terminal to another. Shorting the battery terminals together may cause burns or a fire.

- Under abusive conditions, liquid may be ejected from the battery; avoid contact. If contact accidentally occurs, flush with water. If liquid contacts eyes, additionally seek medical help. Liquid ejected from the battery may cause irritation or burns.

## Service

a) Have your power tool serviced by a qualified repair person using only identical replacement parts. This will ensure that the safety of the power tool is maintained.

## ADDITIONAL SAFETY INSTRUCTIONS FOR BATTERIES AND CHARGERS

### SAFETY WARNINGS FOR BATTERY PACK

- ⚠ **WARNING!** Read all safety warnings and all instructions. Failure to follow the warnings and instructions may result in electric shock, fire and/or serious injury.

### Save all warnings and instructions for future reference.

- Do not dismantle, open or shred cells or battery pack.
- Do not short-circuit a battery pack. Do not store battery packs haphazardly in a box or drawer where they may short circuit each other or be short-circuited by conductive materials. When battery pack is not in use, keep it away from other metal objects, like paper clips, coins, keys,

# SAFETY INFORMATION

Please read these instructions fully before operating or maintaining your machine

nails, screws or other small metal objects, that can make a connection from one terminal to another. Shorting the battery terminals together may cause burns or a fire.

- Do not expose battery pack to heat or fire. Avoid storage in direct sunlight.
  - Do not subject battery pack to mechanical shock.
  - In the event of battery leaking, do not allow the liquid to come into contact with the skin or eyes. If contact has been made, wash the affected area with copious amounts of water and seek medical advice.
  - Seek medical advice immediately if a cell or battery pack has been swallowed.
  - Keep battery pack clean and dry.
  - Wipe the battery pack terminals with a clean dry cloth if they become dirty.
- Battery pack needs to be charged before use. Always refer to this instruction and use the correct charging procedure.
  - Do not maintain battery pack on charge when not in use.
  - After extended periods of storage, it may be necessary to charge and discharge the battery pack several times to obtain maximum performance.
  - Battery pack gives its best performance when it is operated at normal room temperature ( $20\text{ }^{\circ}\text{C} \pm 5\text{ }^{\circ}\text{C}$ ).
  - When disposing of battery packs, keep battery packs of different electrochemical systems separate from each other.
  - Recharge only with the charger specified by manufacturer. Do not use any charger other than that specifically

# SAFETY INFORMATION

Please read these instructions fully before operating or maintaining your machine

provided for use with the equipment. A charger that is suitable for one type of battery pack may create a risk of fire when used with another battery pack.

- Do not use any battery pack which is not designed for use with the equipment.
- Keep battery pack out of the reach of children.
- Retain the original product literature for future reference.
- Remove the battery from the equipment when not in use.
- Dispose of properly.

## SAFETY WARNINGS FOR YOUR BATTERY CHARGER



**WARNING!** Read all safety warnings and all instructions. Failure to follow the warnings and instructions may result in electric shock,

fire and/or serious injury.

## Save all warnings and instructions for future reference.

- This appliance is not intended for use by persons (including children) with reduced physical, sensory or mental capabilities, or lack of experience and knowledge, unless they have been given supervision or instruction concerning use of the appliance by a person responsible for their safety.
- Children should be supervised to ensure that they do not play with the appliance.

## Additional Safety Instructions For Your Battery Charger

- Before charging, read the instructions.
- After charging, disconnect

# SAFETY INFORMATION

Please read these instructions fully before operating or maintaining your machine

the battery charger from the supply mains. Then remove the chassis connection and then the battery connection.

- Do not charge a leaking battery.
  - Do not use chargers for works other than those for which they are designed.
  - Before charging, ensure your charger is matching the local AC supply.
  - For indoor use, or do not expose to rain.
  - The charging device must be protected from moisture.
  - Do not use the charging device in the open.
  - Do not short out the contacts of battery or charger.
  - Respect the polarity “+/-“ when charging.
  - Do not open the unit and keep out of the reach of children.
- Do not charge the batteries of other manufactures or ill-suited models.
  - Ensure that the connection between the battery charger and battery is correctly positioned and is not obstructed by foreign bodies.
  - Keep battery charger's slots are free of foreign objects and protect against dirt and humidity. Store in a dry and frost-free place.
  - When charging batteries, ensure that the battery charger is in a well-ventilated area and away from inflammable materials. Batteries can get hot during charging. Do not overcharge any batteries. Ensure that batteries and chargers are not left unsupervised during charging.
  - Do not recharge non-rechargeable batteries,

# SAFETY INFORMATION

Please read these instructions fully before operating or maintaining your machine

as they can overheat and break.

- Longer life and better performance can be obtained if the battery pack is charged when the air temperature is between 18°C and 24°C. Do not charge the battery pack in air temperatures below 0°C, or above 45°C. This is important as it can prevent serious damage to the battery pack.
- Charge only battery pack of the same model provided by manufacturer and of models recommended by manufacturer.

## ADDITIONAL SAFETY INSTRUCTIONS FOR POLE SAW

### POLE SAW SAFETY WARNINGS

- Keep all parts of the body away when the saw is operating. Before you start the pole saw, make
- sure the saw chain is not contacting anything. A moment of inattention while operating pole saws may cause entanglement of your clothing or body with the saw chain.
- Always hold the pole saw with your right hand on the rear handle and your left hand on the front handle. Holding the pole saw with a reversed hand configuration increases the risk of personal injury and should never be done.
- Wear safety glasses and hearing protection. Further protective equipment for head, hands, legs and feet is recommended. Adequate protective clothing will reduce personal injury by flying debris or accidental contact with the saw chain.
- Do not operate a pole saw in a tree. Operation of a pole saw while up in a tree may result in personal

# SAFETY INFORMATION

Please read these instructions fully before operating or maintaining your machine

injury.

- Always keep proper footing and operate the pole saw only when standing on fixed, secure and level surface. Slippery or unstable surfaces such as ladders may cause a loss of balance or control of the pole saw.
- When cutting a limb that is under tension be alert for spring back. When the tension in the wood fibers is released the spring loaded limb may strike the operator and/or throw the pole saw out of control.
- Use extreme caution when cutting brush and saplings. The slender material may catch the saw chain and be whipped toward you or pull you off balance.
- When transporting or storing the pole saw always fit the guide bar cover. Proper handling of the pole saw will reduce the likelihood of accidental contact with the moving saw chain.
- Follow instructions for lubricating, chain tensioning and changing accessories.
- Improperly tensioned or lubricated chain may either break or increase the chance for kickback.
- Keep handles dry, clean, and free from oil and grease. Greasy, oily handles are slippery causing loss of control.
- Cut wood only. Do not use pole saw for purposes not intended. For example: do not use pole saw for cutting plastic, masonry or non-wood building materials. Use of the pole saw for operations different than intended could result in a hazardous situation.

# SAFETY INFORMATION

Please read these instructions fully before operating or maintaining your machine

## PRECAUTIONS FOR POLE SAW

- Never stand directly under the limb you are trimming. Always position yourself out of the path of falling debris.
- Never stand on a ladder or other type of unstable support while using the pole saw.
- Always use both hands to operate pole saw. Keep a firm, steady pressure on the pole saw while cutting but do not try to force the saw through the wood.
- Do not use the pole saw to cut limbs larger in diameter than the length of the guide bar.
- Keep other persons away from cutting end of pole saw and at a safe distance from work area.
- Do not use pole saw near cable, electric power or telephone lines. Maintain a minimum clearance of 10 feet from all power lines.



### Residual risks

Even when the tool is used as prescribed it is not possible to eliminate all residual risk factors. The following hazards may arise in connection with the tool's construction and design:

- Damage to lungs if an effective dust mask is not worn.
- Damage to hearing if effective hearing protection is not worn.
- Health defects resulting from vibration emission if the appliance is being used over longer period of time or not adequately managed and properly maintained.



**WARNING!** This machine produces an electromagnetic field during operation. This field may under some circumstances interfere with active or passive



# SAFETY INFORMATION

Please read these instructions fully before operating or maintaining your machine

medical implants. To reduce the risk of serious or fatal injury, we recommend persons with medical implants to consult their physician and the medical implant manufacturer before operating this machine.

- The operator or user is responsible for accidents or hazards occurring to other people or their property.

## PREPARE

## TRAINING

- Read the instructions carefully. Be familiar with the controls and the proper use of the appliance.
- Never allow children to use the product.
- Never allow people unfamiliar with these instructions to use the appliance. Local regulations may restrict the age of the operator.
- Never operate the appliance while people, especially children, or pets are nearby.

- Wear safety goggles and ear muffs while operating.
- Always wear substantial footwear and long trousers. Do not operate the equipment when barefoot or wearing open sandals.
- Always wear suitable working clothes during working, which allow freedom of movement.
- Never operate the appliance which is damaged, incomplete or changed without approval of the manufacturer.

# SAFETY INFORMATION

Please read these instructions fully before operating or maintaining your machine

## OPERATE

- Operate the product only in daylight or in good artificial light.
- Do not overreach and keep your balance at all times.
- Always be sure of your footing on slopes.
- Walk, never run.
- Keep all ventilation openings clear of debris.
- Never blow debris in the direction of bystanders.

intended use and is not included in these instructions is considered unauthorized use and relieves the manufacturer from his or her legal liability.

## INTENDED USE

- This machine may only be used outdoors for cutting wood and in combination with the original cutting chains.

This machine is not designed for heavy duty or commercial use.

Any use of the machine that deviates from its

# BOX CONTENT

## PARTS

- |    |                        |    |                                   |
|----|------------------------|----|-----------------------------------|
| 1  | Working head           | 11 | Front handle                      |
| 2  | Oil bottle cap         | 12 | Quick release for telescopic pole |
| 3  | Bar sheath             | 13 | Main switch                       |
| 4  | Guide Bar              | 14 | Hang buckle                       |
| 5  | Saw Chain              | 15 | Konb                              |
| 6  | Battery pack           | 16 | Pole                              |
| 7  | Charger                | 17 | Tension Wheel                     |
| 8  | Charger base           | 18 | Adjusting Wheel                   |
| 9  | Safety lock-off button | 19 | 100ml lubrication oil             |
| 10 | Shoulder strapper      |    |                                   |

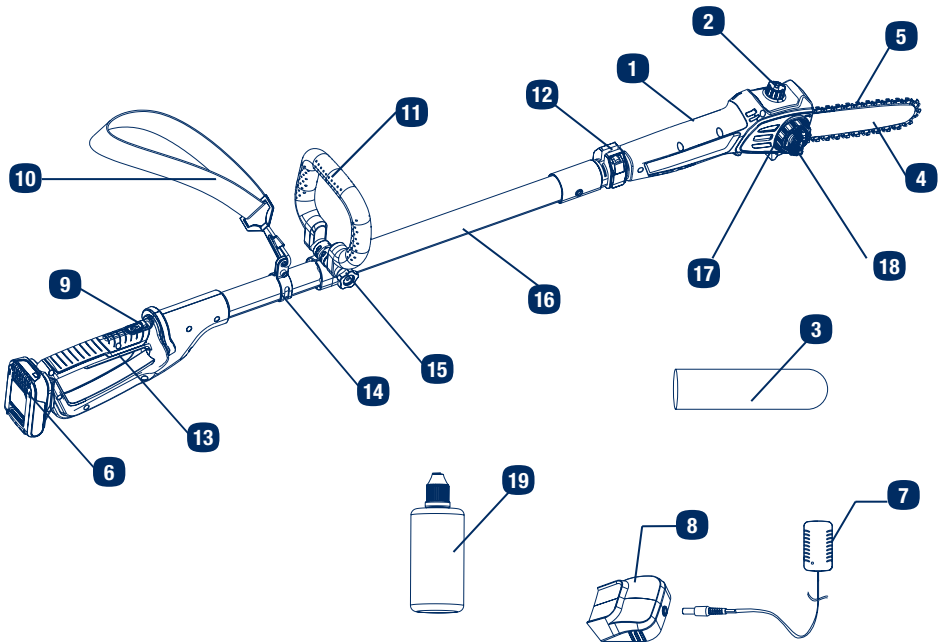

If there are any parts missing, please call the customer helpline on 0345 605 2067

# ASSEMBLE

## 1 Unpacking

- i. Unpack all parts and lay them on a flat, stable surface.
- ii. Remove all packing materials and shipping devices if applicable.
- iii. Make sure the delivery contents are complete and free of any damage. If you find that parts are missing or show damage do not use the product but contact the aftersales service within 28 days of purchase. Using an incomplete or damaged product represents a hazard to people and property.
- iv. Ensure that you have all the accessories and tools needed for assembly and operation. This also includes suitable personal protective equipment.

## 2 Assemble the front handle

- i. Attach the front handle to the block (A) on the lower handle, and insert the bolt. Tighten the knob to the bolt.
- ii. Adjust the front handle forward or backwards to a proper position.

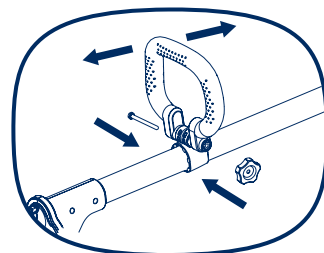
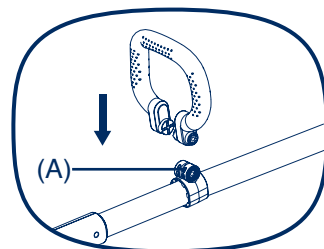

# ASSEMBLE

## 3 Assemble the shoulder strapper

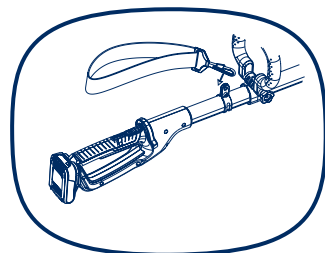

## 4 Fill lubrication oil

- i. Push the oil bottle cap and unscrew it, and add proper lubrication oil.

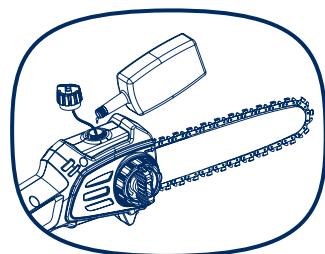

**Note:** Make sure the oil level is between Min and Max.

- ii. Tighten the oil bottle cap.

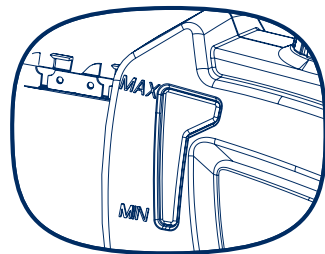

## 5 Charging the battery



**NOTE:** This battery pack has been shipped in a low charge condition. It should be fully charged before first use. Make sure the main voltage is the same as rating label which located on the charger.

### **WARNING!**

The charger and battery pack are specifically designed to work together so do not attempt to use any other devices. Never insert or allow metallic objects into your charger or battery pack connections because an electrical failure and hazard will occur.

The battery needs to be charged before first use and whenever it fails to produce sufficient power on jobs that were easily done before. This product comes with a lithium ion battery pack. Lithium Ion batteries don't lose charge when not in use, and don't lose charging capacity overtime. Never the less it is best practice to charge the battery when empty or insufficient to do the job.

# ASSEMBLE

---

## Connect the mains plug with charger (7) to the charger base (8) .

1. Plug the charger into an appropriate AC power outlet. The LED lights green to tell you that the charger is ready for use.
  2. Slide the charger base (8) into the battery pack (6), make sure the charger base is fully seated in the battery pack. The LED lights up red to tell you that the battery pack is on charge.
  3. The battery pack will be fully charged in 1 hour. And the LED lights up green again to tell you that the battery pack is fully charged.
- 

---

## Important charging notes

Longest life and best performance can be obtained if the battery pack is charged when the air temperature is between 18-24°C. Do not charge the battery pack in a very low or very high air temperature. This is important and will prevent serious damage to the battery pack.

- When using your tool continuously, the batteries in your battery pack will become hot. You should let a hot battery pack cool down for approximately 30 minutes before attempting to recharge.
  - The charger and battery pack may become warm to touch while charging. This is a normal condition, and does not indicate a problem.
  - Use the charger in normal room temperatures whenever possible. To prevent overheating, do not cover the charger and do not charge battery packs in direct sunlight or near heat sources.
  - If the battery pack does not charge properly;
    - (1). Check the main socket by plugging in a lamp or other appliance.
    - (2). Move the charger and battery pack to a location where the surrounding air temperature is approximately 18-24°C.
    - (3). If charging problems persist, take or send the tool, battery pack and charger to your local service center.
  - The battery pack should be recharged when it fails to produce sufficient power on jobs which were easily done previously. **DO NOT CONTINUE** to use under these conditions. Follow the charging procedure. You may also charge a partially used pack whenever you desire with no adverse effect on the battery pack.
  - Under certain conditions, with the charger plugged in to the power supply, the exposed charging contacts inside the charger can be shorted by foreign material. Foreign materials of a conductive nature such as, but no limited to, steel wool, aluminum foil, or any buildup of metallic particles should be kept away from charger cavities. Always unplug the charger from the power supply when there is no battery pack in the cavity. Unplug charger before attempting to clean.
  - Do not immerse charger in water or any other liquid.
-

# ASSEMBLE



## WARNING!

Don't allow any liquid to get inside charger. Electric shock may result. To facilitate the cooling of the battery pack after use, avoid placing the charger or battery pack in a warm environment such as in a metal shed, or an un-insulated trailer.



## CAUTION!

Never attempt to open the battery pack for any reason. If the plastic housing of the battery pack breaks or cracks, return to a service center for recycling; do not put it into further use.

7

## Check battery capacity

Push the power indicator button, the remaining percentage of battery capacity will show on screen.

**FU** means 100% fully charged.

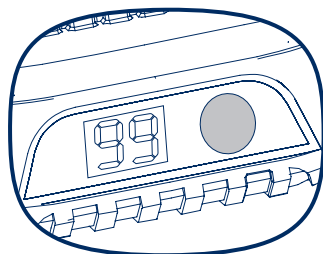

### General operation

- i. Check the product, its battery pack as well as accessories for damage before each use. Do not use the product if it is damaged or shows wear.
- ii. Double check that accessories or cutting device are properly fixed.
- iii. Always hold the product on its handles. Keep the handles dry to ensure safe support.



# OPERATE

## Telescopic handle adjustment

- i. Lift the clamping lever and extend upper part of handle to desired handle length. Then push the clamping lever to fix the tube tight.

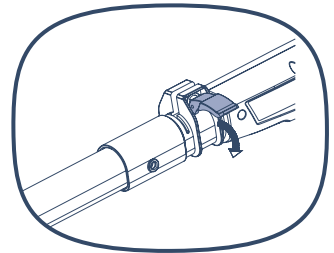
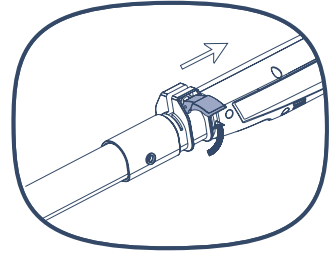

## Install battery pack

- i. Keep the battery pack in line with the holder on the device.
- ii. Push it forward until it reaches the bottom. Before starting make sure the battery pack is firmly locked in place.

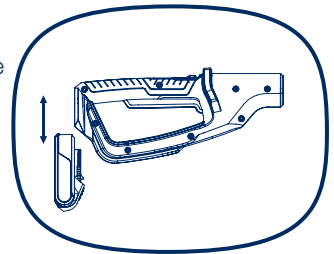

## Remove the battery from product

- i. Press the battery pack release button (A) downward,
- ii. Pull the battery pack towards operator, then remove it.

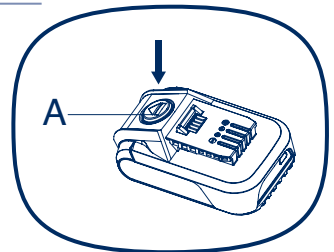

# OPERATE



**Attention!** The battery cannot be charged immediately after use, it should cool off for a period of time. The LED lights switching from green to red means it can be charged.

## Switch on/off



**NOTE:** Hold the pole saw away from yourself using both hands. Stand in a secure and stable position.

- i. Push safety switch (10) forward, and press the on/off switch (14) to turn the product on.
- ii. Release the on/off switch (14) to turn the product off.

## Check the oil supply



**NOTE!** With the pruner fully assembled and adjusted it is important to check the chain oil supply is dispensing adequate lubrication.

After switching on, run the chain and see if chain oil is being dispensed as shown.

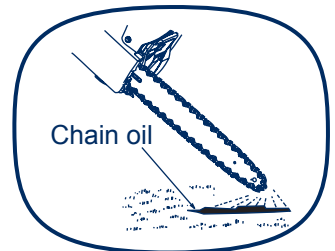

# OPERATE

## Chain Tension

1. Loosen tension wheel (5) before adjusting chain.
2. Turn the adjusting wheel (6) until slack is out of chain.
3. Wearing protective gloves, pull down on chain to check chain tension
4. Do not over-tension chain. Over-tensioning will cause excessive wear and will reduce the life of the guide bar and chain. Over-tensioning also reduces the amount of cuts per battery charge.
5. After chain tension is correct, tighten tension wheel (5) firmly.

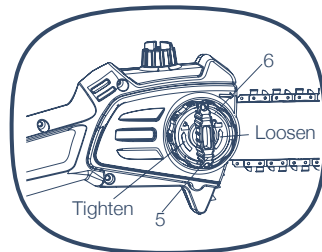

### Important!

It is very important to adjust the chain tension if the chain is loose.

Check that if the chain is loose in every 10mins.



**NOTE!** When tensioned correctly it should be possible to pull one full chain link free of the bar channel with ease.

- A new chain will expand its length during the first period of use. Check and re-adjust the tension frequently as a loose chain can easily derail or cause rapid wear of itself and the chain bar.

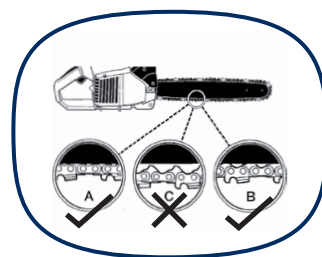

**CAUTION!** If the saw chain is TOO LOOSE or TOO TIGHT the V-drive wheel, chain bar, chain and crank shaft bearing will suffer premature wear. Above Fig. shows the correct tension A (when cold) and tension B (when warm). Fig. C shows a chain that is too loose.

# OPERATE

## Pruning



**Warning!** Always turn off the motor before laying down the machine!  
Risk of recoil!  
Recoil is caused by wood or other firm objects coming into contact with the top side or the tip of the saw rail. This may cause the machine to be thrown back with force at the operator, which may cause serious injuries.



**Warning!** Danger of injury!  
Dangerous recoil may occur during the operation of the machine! This may cause serious injuries or death!

Make absolutely sure that no wood or other firm objects can come into contact with the area shown in the diagram on the right.

Only if you work carefully and properly can you reliably reduce the risk of recoil!

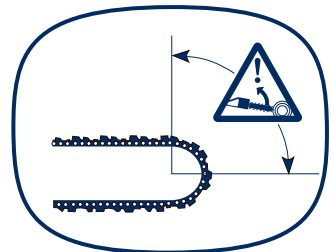

## Pull sawing

This technique involves sawing with the bottom side of the saw rail from top to bottom. The sawing chain pushes the machine forward away from the operator. The front edge of the machine forms a support rest absorbing the forces caused by sawing into a tree trunk.

Pull sawing allows the operator to exercise much more control over the machine and to prevent it from recoiling. This is why you should make pull sawing the sawing technique of your choice.

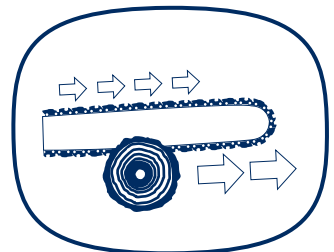

# OPERATE

## Push sawing

This technique involves sawing with the top side of the saw rail from bottom to top. The sawing chain pushes the machine backward toward the operator. If the saw rail becomes jammed, the machine may be thrown back toward the operator with great force.

If the operator is unable to counterbalance the backward pushing force of the sawing chain by his own body weight, only the tip of the sawing chain may be in contact with the wood, which may cause a recoil.

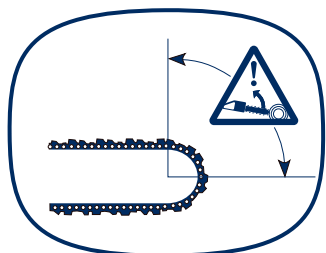
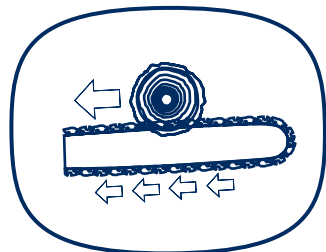

## Tree cutting

Note! Always work on the opposite side of the branch you want to cut down. Always start at the bottom of the trunk and work your way up.

When removing larger branches, first cut the branch from below (1).

Then cut through from above (2), and finally cut off the remaining branch (3).

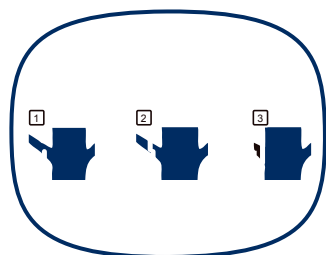

Danger of injury. Branches that rest against a surface or are under tension may cause the sawing chain to become jammed in the wood!

# MAINTENANCE

**This product does not contain any parts that can be repaired by the consumer. Contact an authorised service centre or a similarly qualified person to have it checked and repaired.**



**WARNING!** Always switch the product off, disconnect it from the battery pack and let the product cool down before performing inspection, maintenance and cleaning work!

## General cleaning

- i. Switch the product off, disconnect it from the battery pack and let it cool down.
- ii. Check, clean and store the product as described below.
- iii. Clean the product with a damp cloth and pH-neutral soap.

Use a brush for areas that are hard to reach.

- iv. In particular clean the air vents after every use with a cloth and brush.
- v. Remove stubborn dirt with high pressure air (max. 3 bar).



**NOTE:** Do not use chemical, alkaline, abrasive or other aggressive detergents or disinfectants to clean this product as they might be harmful to its surfaces.

# MAINTENANCE

## Change the chain and bar

i. Loosen tension wheel (A). Remove chain cover with adjusting wheel together.

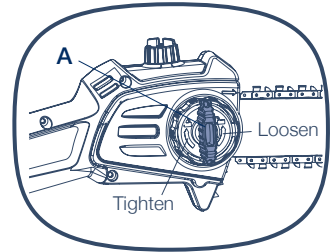

ii. Fit the chain around the bar ensuring that the direction of the chain is as depicted in the picture on the bar. Fit the chain on the sprocket.

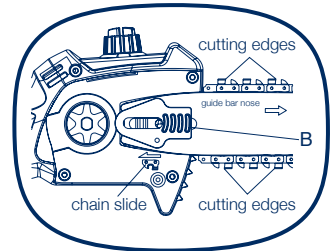

**Note:** Make sure cutting edges of chain are facing in right direction. Make sure the tension guide plate (B) is facing outside.

## Change the chain and bar

i. Loosen tension wheel (A). Remove chain cover with adjusting wheel together.

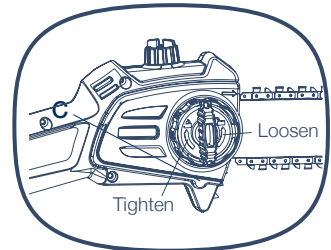

## Saw Chain Tension Adjustment

1. Loosen tension wheel (5) before adjusting chain.
2. Turn the adjusting wheel (6) until slack is out of chain.
3. Wearing protective gloves, pull down on chain to check chain tension
4. Do not over-tension chain. Over-tensioning will cause excessive wear and will reduce the life of the guide bar and chain. Over-tensioning also reduces the amount of cuts per battery charge.

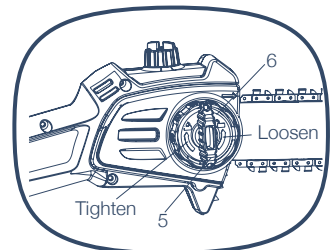

# MAINTENANCE

5. After chain tension is correct, tighten tension wheel (5) firmly.



**NOTE!** When tensioned correctly it should be possible to pull one full chain link free of the bar channel with ease.

- A new chain will expand its length during the first period of use. Check and re-adjust the tension frequently as a loose chain can easily derail or cause rapid wear of itself and the chain bar.

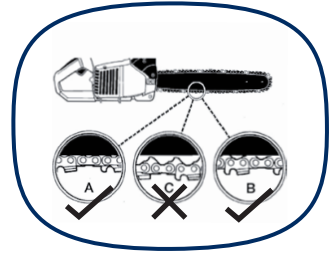

**CAUTION!** If the saw chain is TOO LOOSE or TOO TIGHT the V-drive wheel, chain bar, chain and crank shaft bearing will suffer premature wear. Above Fig. shows the correct tension A (when cold) and tension B (when warm). Fig. C shows a chain that is too loose.

## Care of Guide Bar

Uneven bar wear causes most guide bar problems. Incorrect sharpening of chain cutter and depth gauge settings often cause this. When bar wears unevenly, it widens guide bar groove. This causes chain clatter and rivet popping. Saw will not cut straight. Replace guide bar if this occurs.

Inspect guide bar before sharpening chain. A worn or damaged guide bar is unsafe. A worn or damaged guide bar will damage chain. It will also make cutting harder.

## Normal Guide Bar Maintenance

1. Reverse the bar occasionally to prevent partial wear.
2. The bar rail should always have parallel internal faces (see



# MAINTENANCE

diagram). Check for wear of the bar rail. Apply a ruler to the bar and the outside of a cutter. If a gap is observed between them, the rail is normal. Otherwise, the bar rail is worn. Such a bar needs to be corrected or replaced.

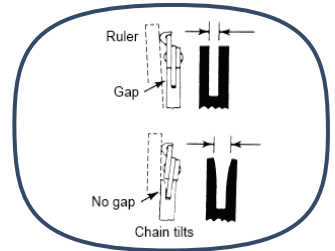

## Sharpening Saw Chain

Keep chain sharp. Your saw will cut faster and more safely. A dull chain will cause undue sprocket, guide bar, chain, and motor wear. If you must force chain into wood and cutting creates only sawdust with few large chips, chain is dull.

## Sharpening Cutters

Use file guide for 30° filing.

1. Make sure the saw is held securely.
2. Make sure the battery is taken off.
3. Adjust chain for proper tension.
4. Clamp guide bar in vise to hold saw steady. (Note: Do not clamp chain.)
5. Press 5/32" round file (attached to file guide) into groove between top plate and depth gauge on chain. File guide should rest on both top plate and depth gauge. (Note: File at midpoint of guide bar.)

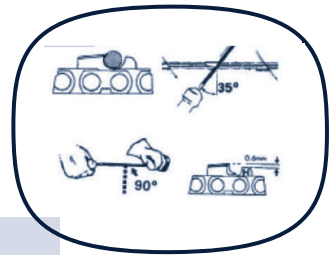

**Note:** This illustration shows file guide placement and filing direction for sharpening cutters on left side of chain.

6. Hold file guide level. Make sure 30° mark on file guide is parallel to center of guide bar. This will insure that you file cutters at 30° angle.
7. File from inside towards outside of cutter until sharp. Only file in this one direction. (Note: Two or three strokes with file should sharpen cutter.)

# MAINTENANCE

## Filing Cutter Depth Gauges

The cutter depth gauge clearance is reduced as cutters are sharpened. After every second or third sharpening, reset cutter depth gauges.

1. Place depth gauge tool (.025") firmly across top of two cutters. Make sure depth gauge enters slot in depth gauge tool.
2. Use medium flat file. File depth gauge level with depth gauge tool.
3. Remove depth gauge tool. With flat file, round off front corner of cutter depth gauge.

After several hand filings, have authorized service center or sharpening service machine sharpen chain. This will insure even filing.

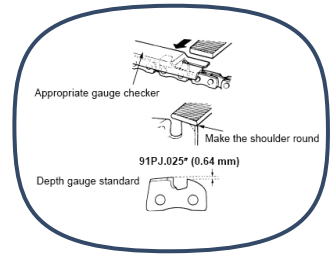

## Cleaning the bar and saw



**WARNING!** Wear safety gloves when working on blades and close to it! Use appropriate tools to remove debris, e.g. a brush or wooden stick! Never use your bare hands!

Always use original spare parts for replacement.

- i. Keep the bar and chain clean and free of debris. Remove debris.
- ii. Apply a small amount of suitable lubricant, like gear grease, on the cutting device to retain a good cutting performance.

# MAINTENANCE

## Recycling and disposal

- i. Waste electrical products should not be disposed of with household waste. Please recycle where facilities exist. Check with your Local Authority or local store for recycling advice.
- ii. The product comes in a packaging that protects it against transportation damage. Keep hold of the packaging until you are sure that all the parts have been delivered and the product is functioning properly. Recycle the packaging afterwards.
- iii. To preserve natural resources, please recycle or dispose of batteries properly. This product contains a lithium-ion battery. Local, provincial or federal laws may prohibit disposal of lithium-ion batteries in ordinary trash. Consult your local waste authority for information regarding available recycling and/or disposal options.

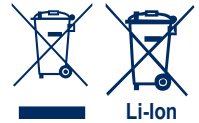

## Storage

1. Make sure that the product has been thoroughly cleaned before storing it in a clean dry place out of the reach of children.
2. Remove and clean guide bar and chain. Clean guide bar and chain by soaking in petroleum based solvent or mild soap and water mixture. Place chain in container filled with oil. This will prevent rust.

# TROUBLESHOOTING

<b>Problem</b>	<b>Possible cause</b>	<b>Solution</b>
Product not running.	<ul style="list-style-type: none"><li>- Battery discharged</li><li>- Battery pack does not sit its place correctly</li><li>- Device defective</li></ul>	<ul style="list-style-type: none"><li>- Charge rechargeable battery</li><li>- Install the battery pack once again</li><li>- Contact service center</li></ul>
Chain does not cutting properly	<ul style="list-style-type: none"><li>-Incorrectly mounted saw chain</li><li>-Saw chain blunt</li><li>-Chain tension insufficient</li></ul>	<ul style="list-style-type: none"><li>-Mount saw chain correctly</li><li>-Sharpen cutting teeth or place on new chain</li><li>-Check chain tension</li></ul>
Bar and chain running hot and smoking.	<ul style="list-style-type: none"><li>-Too little oil</li><li>-Tension over tightened</li></ul>	<ul style="list-style-type: none"><li>-Check bar lube reservoir, where appropriate, refill with oil</li><li>-Tension chain. Refer to Chain Tension in this manual</li></ul>

# TECHNICAL DATA

Model	M0L-10ET-200
Nominal voltage of product with battery	18 V d.c.
Chain speed	2.8m/s
Cutting length	20 cm
Bar/chain code	080SDEA041/91P033X
Net weight	3.75 kg
Vibrations	1.5 m/s <sup>2</sup> , K=1.5 m/s <sup>2</sup>

Charger	
Model no.	SMVCH001212000B
Input voltage & power	230-240V~ 50/60Hz, 50W
Output voltage & current	21V d.c. 2A
Charger time	60mins

Battery pack	
Model no.	B0P-SP02-20-15A
Battery type	Lithium-Ion
Battery capacity	18V d.c. 1.5Ah 27Wh

PART NUMBER	ACCESSORIES
CGT-04	Battery pack
080SDEA041	Bar
91P033X	Chain
CGT-50	Charger

# TECHNICAL DATA

A weighted sound pressure: 78dB(A),  $K_{PA}=2$ dB(A)

A weighted sound power: 93dB(A),  $K_{WA}=2$ dB(A)

The guaranteed sound power level: 93dB(A)

Wear ear protection

The sound values have been determined according to noise test code given in EN 60745-1 ENISO 3744, using the basic standards EN 60745-1.

The sound intensity level for the operator may exceed 80dB(A) and ear protection measures are necessary.

The declared vibration value has been measured in accordance with a standard test method (according to EN60745-1+EN ISO 11680-1) and may be used for comparing one product with another. The declared vibration value may also be used in a preliminary assessment of exposure.

WARNING! Depending on the actual use of the product the vibration values can differ from the declared total! Adopt proper measures to protect yourself against vibration exposures! Take the whole work process including times the product is running under no load or switched off into consideration!

Proper measures include among others regular maintenance and care of the product and cutting attachments, keeping hands warm, periodical breaks and proper planning of work processes!

# WARRANTY

If your device develops a fault, please don't hesitate to contact our customer service department on 0345 605 2067, the majority of problems can be solved directly on the phone.

1. These warranty terms cover additional warranty rights and do not affect your statutory warranty rights. All our products are covered by a 3 year manufacturer warranty.
2. Claims must be accompanied by proof of purchase. This must be in the form of a Sales receipt or bank statement and must show that the product has been purchased within the warranty period as described under point 1, from the retailer that it was originally bought from. Please keep your receipt safe or staple it to the back of this manual for future reference.
3. Our warranty covers problems caused by material or manufacturing defects, and will result in the repair of these defects or replacement of the device with a like for like or similar article.
4. Our devices have not been designed for commercial, trade or industrial applications, any signs of use of the equipment in these application or equivalent activities, invalidates the warranty.
5. The following are also excluded from our warranty:
  - A. Faults due to accidents, customer misuse or unauthorized repairs
  - B. Consumable Parts such as batteries, chargers, blades, quick release locks, and other accessories that are compatible with the product.
  - C. Failure due to lack of routine maintenance.
  - D. Failure as a result of not using the equipment in accordance with the manual and safety instructions
  - E. The adjustment of cables, chargers, or battery packs

Warranty claims should be submitted before the end of the warranty period, see point 1, but a paid service exists for repairs commissioned after this period. The original warranty period remains applicable to the device even if repairs are carried out or parts are replaced.

In such cases, the work performed or parts fitted will not result in an extension of the warranty period, and no new warranty will become active for the work performed or parts fitted.

If you have any problems or questions concerning your garden power tool, please contact our after sales service at 0345 605 2067.