

EXTENDING METAL PET GATE XTRA TALL  
care & instruction manual

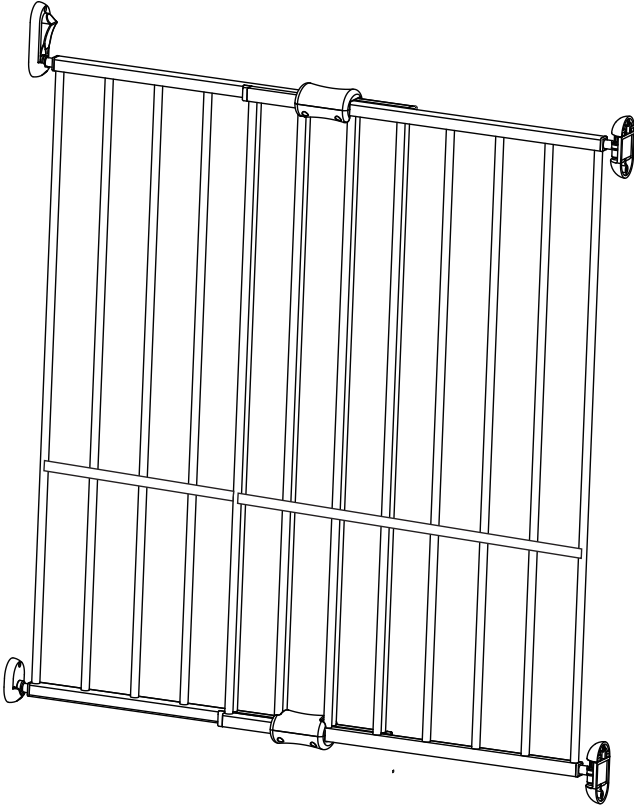

**IMPORTANT**

KEEP THESE INSTRUCTIONS FOR FUTURE REFERENCE

Cat.No.: 9569690

# IMPORTANT! READ AND FOLLOW THESE INSTRUCTIONS CAREFULLY AND KEEP FOR FUTURE REFERENCE

## Introduction

Please read the instructions thoroughly to ensure proper installation.

Please immediately inspect your safety gate upon receipt. If you see any damage, or additional parts are required for this gate, do not assemble gate and please go to back page of the instruction booklet for website or Consumer Relations Representative information. We recommend that you carry out the installation away from young children as some of the smaller components may present a choking hazard when loose.

## Important Information

Please check the gate on a regular basis to ensure gate and parts are all in proper working order.

If the safety barrier is used at the top of the stairs, that it shall not open over the stairs. When using at top of stairs, gate must open away from stairs.

If the gate is used at the bottom of the stairs, please place towards the front of the lowest tread.

Ensure the gate is attached between two clean and solid surfaces.

Ensure appropriate fixings are used for drywall, wood, brick, etc. If wall plugs are provided with the gate and do not secure to the wall satisfactorily, consult with a hardware store for your proper wall plug application. If additional parts are required for this gate, please go to back page of the instruction booklet for website or Consumer Relations Representative information.

## Disclaimer

Any safety gate which has been subjected to misuse, abuse, abnormal use, excessive wear and tear, improper assembly, negligence, environmental exposure, alteration or accident, or has had its serial number altered or removed invalidates any and all claims against the manufacturer. Any damage to property during installation of your safety gate is the sole responsibility of the end user.

# WARNING!

- **WARNING**– Never use with a child able to climb over or dislodge the gate or enclosure.
  - **WARNING**– Do not use the safety barrier if any components are damaged or missing .
  - **WARNING**– Incorrect installation can be dangerous.
  - **WARNING**– The safety barrier must not be fitted across windows.
  - **WARNING**– Always check that the barrier is properly closed.
  - **WARNING**– Don't install a second gate above the first as there is a risk of serious injury or death.
- 
- Check that the safety barrier is correctly closed.  
It is manual closing system.
  - To prevent serious injury or death, securely install gate or enclosure. And use according to manufacturer's instructions.
  - Safety barrier should be checked regularly to ensure it is secure and functioning in accordance with these instructions.
  - Additional or replacement parts should only be obtained from the manufacturer or distributor.
  - Adjust to fit opening between 60cm and 97cm.
  - Do not allow older children to climb on or over the gate as this can result in an accident.
- 
- Safety barrier is suitable for use with children up to 24 months of age.
  - This product will not necessarily prevent all accidents. Never leave child unattended.
  - This safety barrier complies with EN1930:2011.
  - This safety barrier is for indoor domestic use only.
  - To clean: Use mild soap and wipe with a damp cloth.
  - Adult assembly required.
  - Install according to manufacturer's instructions.

# A Guide to Wall Mounting & Fixings

## Important note:

If plastic wall plugs (rawl plugs) are supplied with your product, e.g.:



- these are only suitable for use in masonry walls.

If you are in any doubt about the correct wall plugs for your wall, seek professional advice.

Failure of the product due to using the incorrect fixings is the responsibility of the installer.



**Important:** when drilling into walls always check that there are no hidden wires or pipes etc.

**Make sure that the screws and wall plugs being used are suitable for supporting your unit. Consult a qualified tradesperson if you are unsure.**

### Hints:

- 1: General rule:  always use a larger screw and wall plug if you are not sure.
- 2: Ensure you use the recommended drill bit to match the wall plug and hole size.
- 3: Ensure you drill the hole horizontally; do not force the drill or enlarge the hole.
- 4: Take extra care when drilling high walls, ceilings and ceramic tiles. Ensure wall plugs are inserted beyond the thickness of the ceramic tiles to avoid the tiles splitting or cracking.
- 5: Ensure wall plugs are well fitted and are a tight fit in the drilled hole.

## Types of walls

You can use one of the following types of wall plug if your walls are made of brick, breeze block, concrete, stone or wood.

### No.1 "General Purpose" wall plug

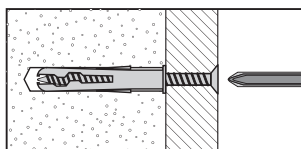

Generally aerated blocks should not be used to support heavy loads, use a specialist fitting in this case. For light loads, general purpose wall plugs can be used.

### No.3 "Cavity Fixing" wall plug

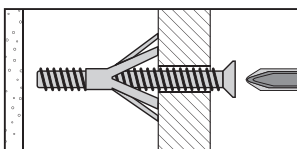

For use with plasterboard partitions or hollow wooden doors.

### No.5 "Hammer Fixing" wall plug

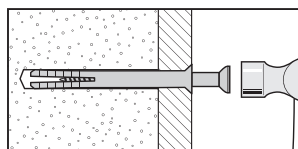

For use with walls stuck with plasterboard. The hammer fixing allows it to be fixed to the wall rather than the plasterboard. Always check the fixing is secure to the retaining wall.

### No.2 "Plasterboard" wall plug

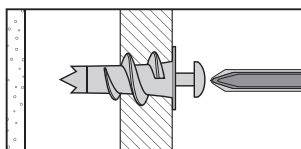

For use when attaching light loads onto plasterboard partitions.

### No.4 "Cavity Fixing - Heavy Duty" wall plug

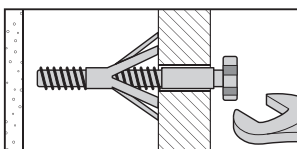

For use when fitting or supporting heavy loads such as shelving, wall cabinets and coat racks.

### No.6 "Shield Anchor" wall plug - heavy loads

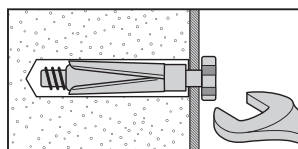

For use with heavier loads such as TV and HiFi speakers and satellite dishes etc.



## Care & Maintenance

**Safety:** always check the fitting and location to ensure your safety in and around the home.

**Fitting:** from time to time check the fitting to ensure the wall plugs or screws do not become loose.

If you need help or have any question, call the Argos Aftersales Helpline: 0345 640 2020



A (8x)



B (8x)

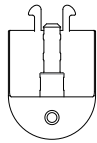

C (2x)



D (2x)

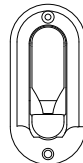

E (1x)



F (1x)

G (1x)

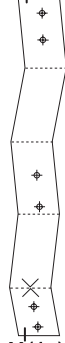

H (1x)

I 1 (1x)

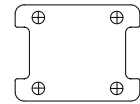
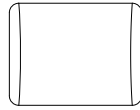

I 2 (1x)

J 1 (1x)

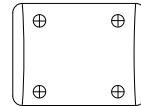
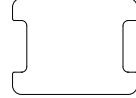

J 2 (1x)

O (1x)



P (1x)

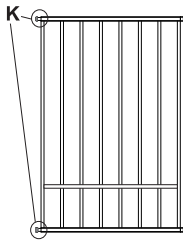
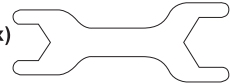

M (1x)

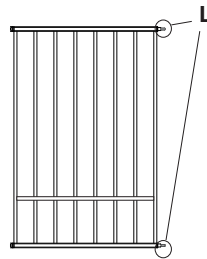

N (1x)

**TOOL REQUIRED**

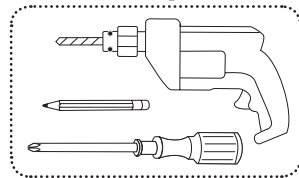

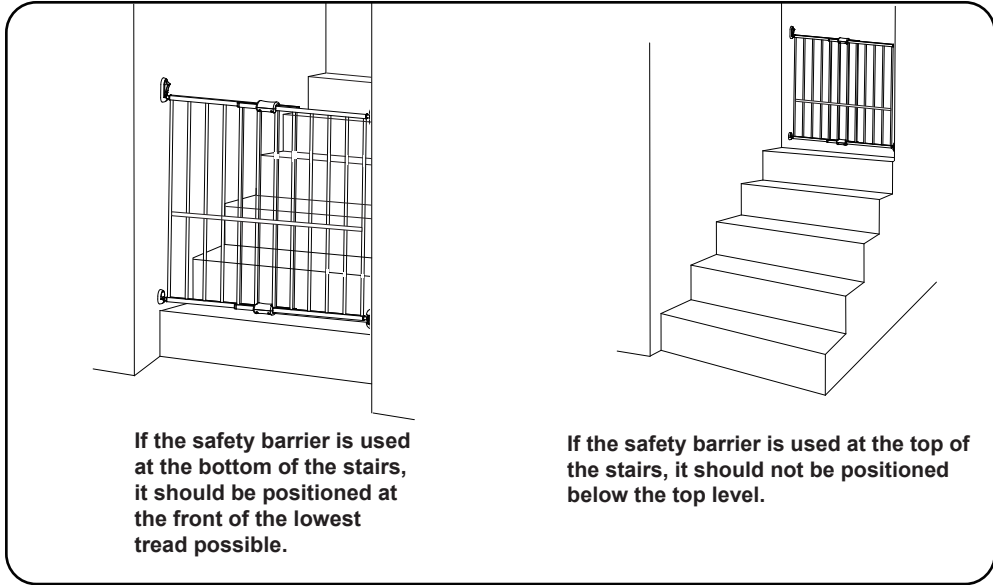
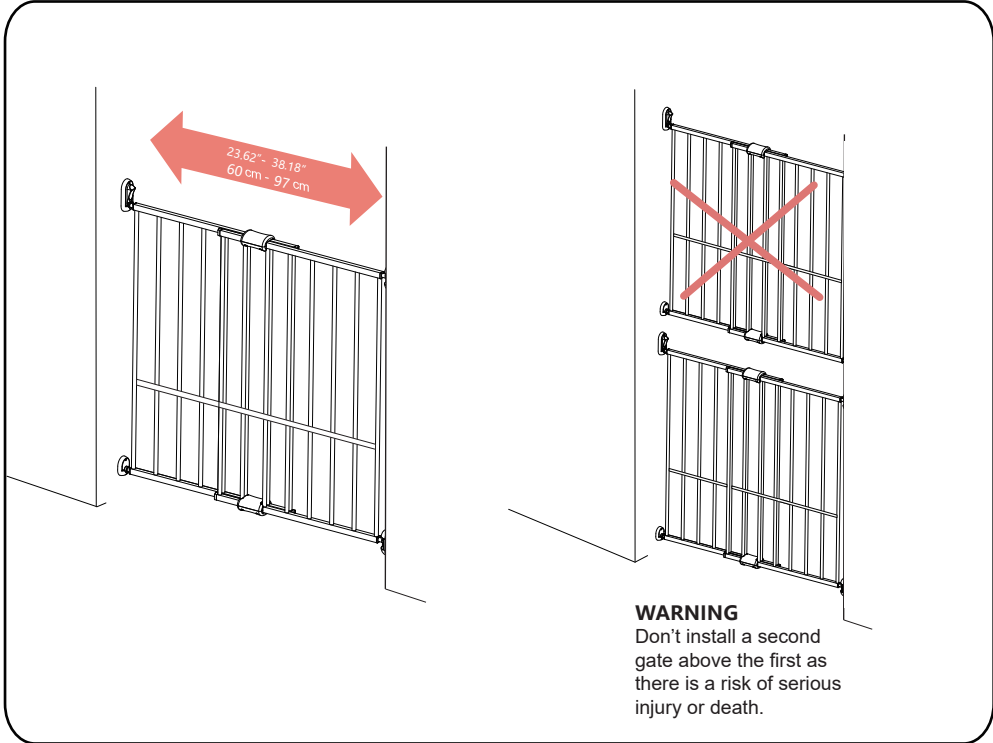

1

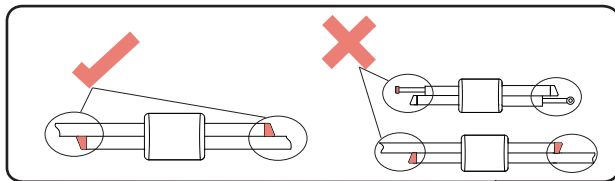

Before you begin, measure the opening to make sure your gate is wide enough for the entire opening. You could adjust the dimension of the gate with components (I 1), (I 2), (J 1) and (J 2).

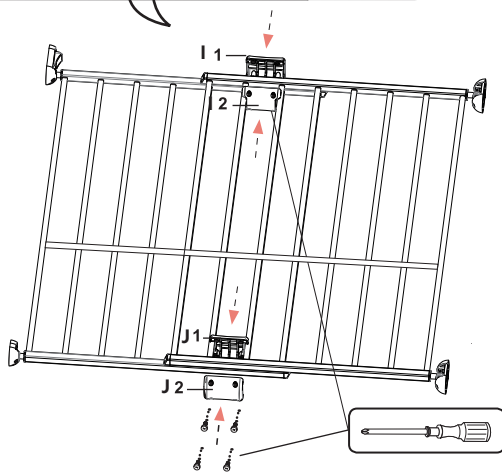

23.62" - 38.18"  
60cm - 97cm

2

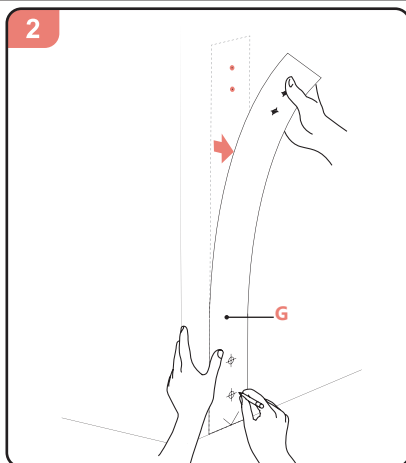

3

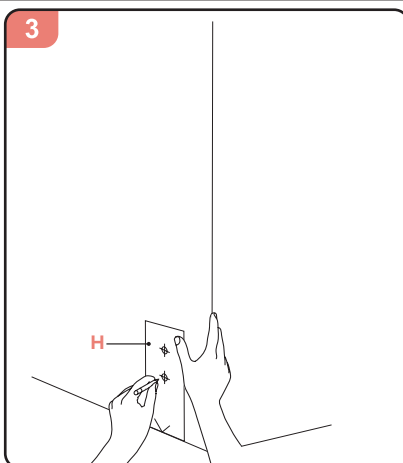

Cut the installation template following the dotted line. Stick the longer one (G) in one side of wall and shorter one (H) to the directly opposite wall. The dotted line should be full attached the floor and make sure the template stand in vertical. Then mark the position of the holes.

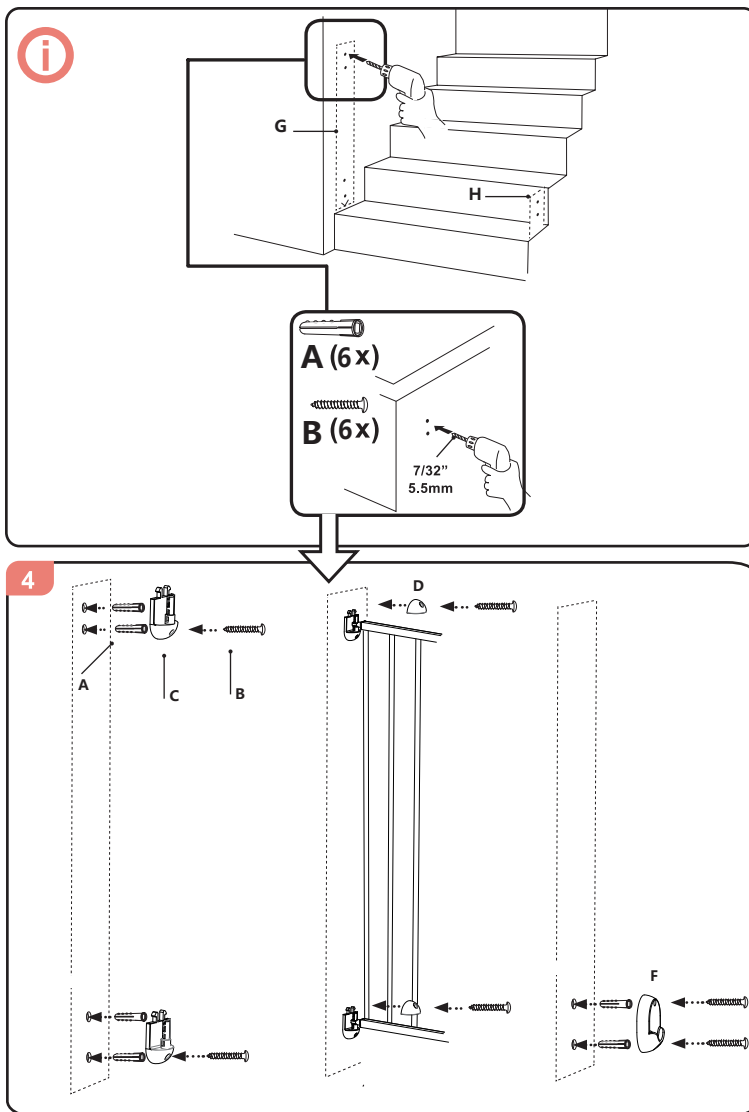

Drill 5 mm hole for the 6 marked positions, then put wall plugs (A), and use screw (B) to fix component (C) and (F).

Adjust the gate width to fit the door width by bolts (K) and (L).  
Caution: please refer to page 9 to make correct length adjustment.

Put on the gate on (C) and (F), then use screw (B) to fix component (D).

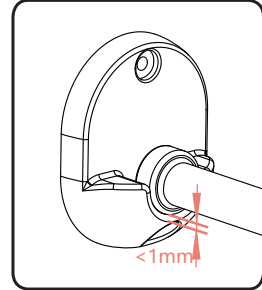
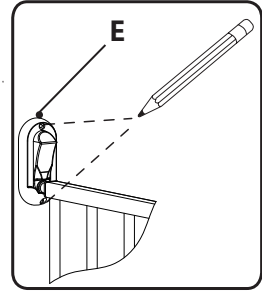
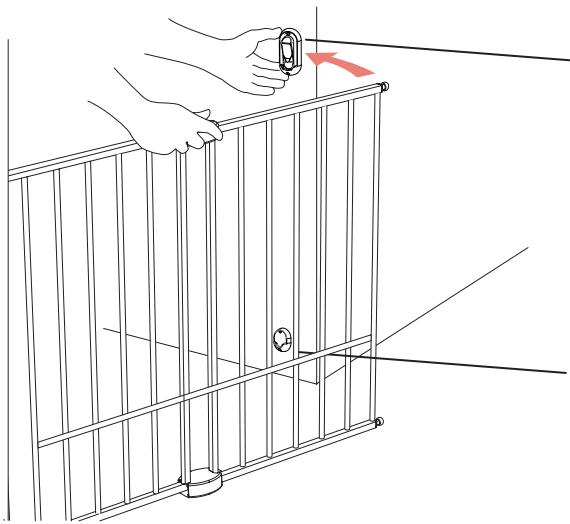

Locate the 2 holes position before (E) to be mounted on the wall.  
 Drill 5 mm holes, put wall plug (A), then use screw (B) to fix component (E).  
 Please ensure the spindle in the plastic groove and the bottom gap no more than 1mm.

Please ensure the spindle in the upper switch and the upper, bottom and side gap no more than 1mm.

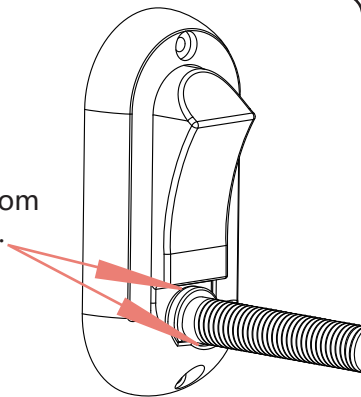



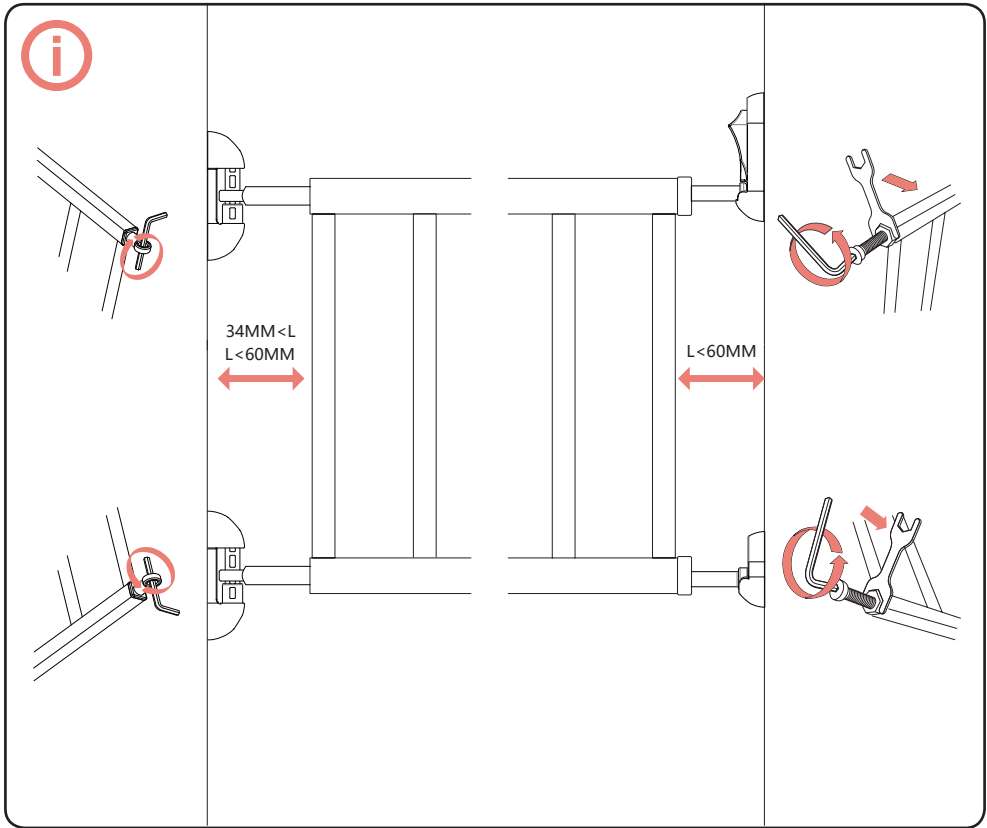

Use the tools provided to adjust bolts (K) and (L) to make the gate width to fit the door properly as below safety requirement:  
Caution: To ensure that this distance between each side of the gate and the wall is less than 60mm. Meanwhile, the distance between the fixed side of the gate and wall must be more than 34mm.

6

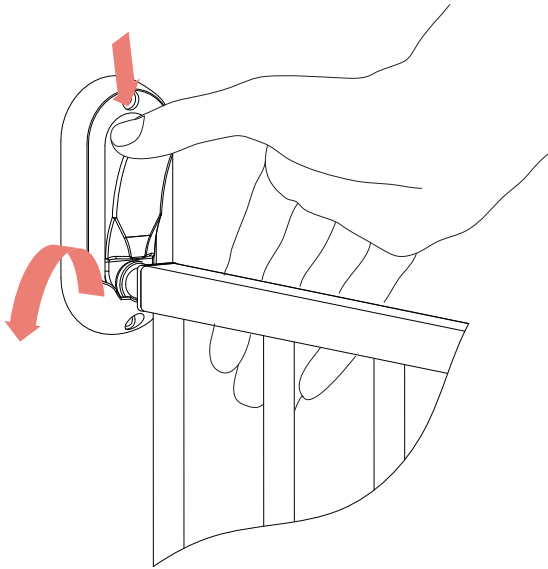

One-handed use, press down the button and lift the gate for two way opening.

Use the tools provided to adjust bolt k to get smooth lock and unlock operation.

Caution: Check the lock function before each use!

## **Customer care**

### **Your child's safety is your responsibility**

If you have a problem with this product or require replacement parts, please contact your nearest Argos store or telephone the Argos Customer Care Team on 0345 640 2020

Alternatively write to:

#### **Customer Care Team**

Produced in China. Sainsbury's Supermarkets Ltd. 33 Holborn, London, EC1N 2HT. Sainsbury's (NI) Ltd, Forestside Shopping Centre, Upper Galwally, Belfast, United Kingdom, BT8 6FX. Argos Limited, 489-499 Avebury Boulevard, Milton Keynes, MK9 2NW. Argos (N.I.) Ltd, Forestside Shopping Centre, Upper Galwally, Belfast, United Kingdom, BT8 6FX. Argos Distributors (Ireland) Limited, Unit 7, Ashbourne Retail Park, Ballybin Road, Ashbourne, County Meath, Ireland.