

# Wooden Hook Shelf - White

HOME

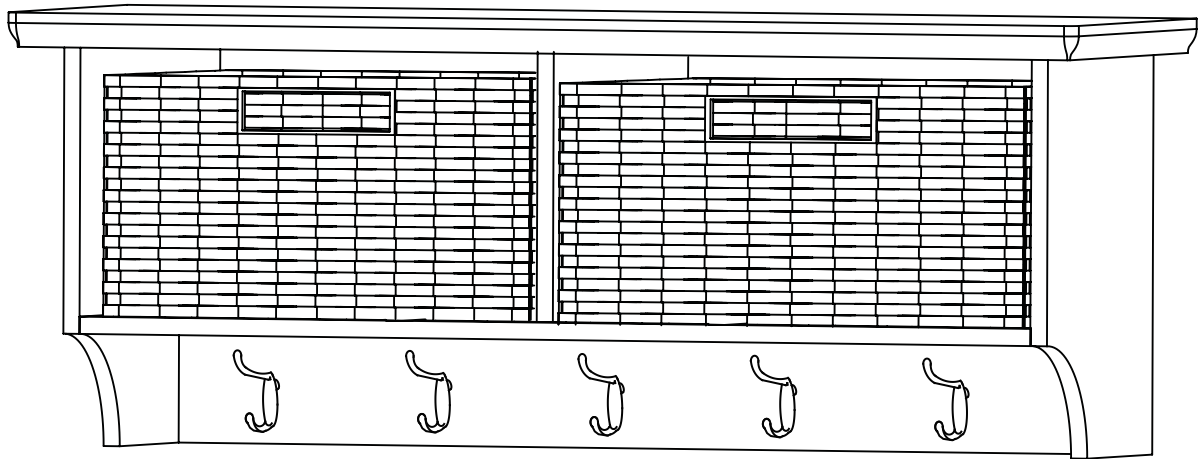

## Spare Parts

 [www.argos-support.co.uk](http://www.argos-support.co.uk)

 [Help@ClickSpares.co.uk](mailto:Help@ClickSpares.co.uk)

 0370 112 1928

## Customer Support

 0345 640 2020



# Safety and Care Advice

---

## Product Details

9486003

## IMPORTANT, RETAIN FOR FUTURE REFERENCE: READ CAREFULLY.

- Keep children and animals away from the work area, small parts could choke if swallowed.

- Make sure you have enough space to layout the parts before starting.

- This product has been constructed to be used in the domestic environment only and not for commercial purposes.

- Assemble the item as close to its final position (in the same room) as possible.

- Assemble on a soft level surface to avoid damaging the unit or your floor.

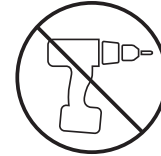

- We do not recommend the use of power drill/drivers for inserting screws as this could damage the unit. Only use hand screwdrivers.

- Parts of the assembly will be easier with 2 people.

- Dispose of all packaging carefully and responsibly.

## Care and maintenance

---

- Only clean using a damp cloth and mild detergent. Do not use abrasive cleaners.

- Use a dry cloth to clean the product, furniture polish is not recommended.

- From time to time check that there are no loose screws, nuts or bolts. If there are please re-tighten.

- This product should not be discarded with household waste. Take to your local authority waste disposal centre.

## Additional Guidance

---

- Assemble all parts and bolts loosely during assembly, only once the product is complete should you fully tighten the bolts.

- Regularly check and ensure that all bolts and fittings are tightened properly.

- Maximum loading weight 5kg each hook

# Tools required

---

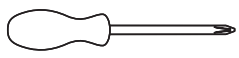

Phillips screwdriver  
(medium)



Drill Heads

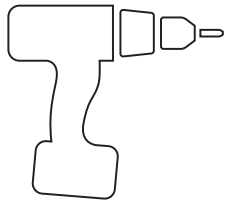

Power Drill

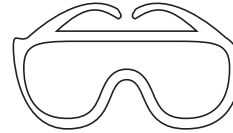

Eye protection  
(when using a  
hammer or glue)



Small  
hammer

# Hook Shelf

---

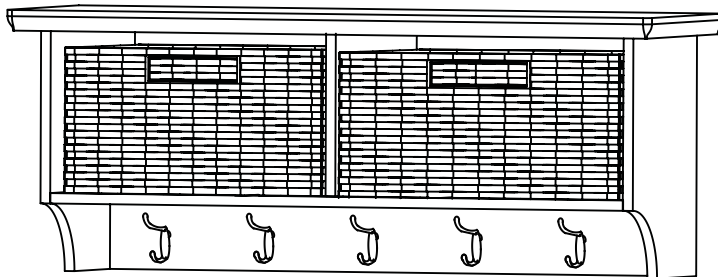

1 Hook Shelf  
(600x200x300mm)

# 1

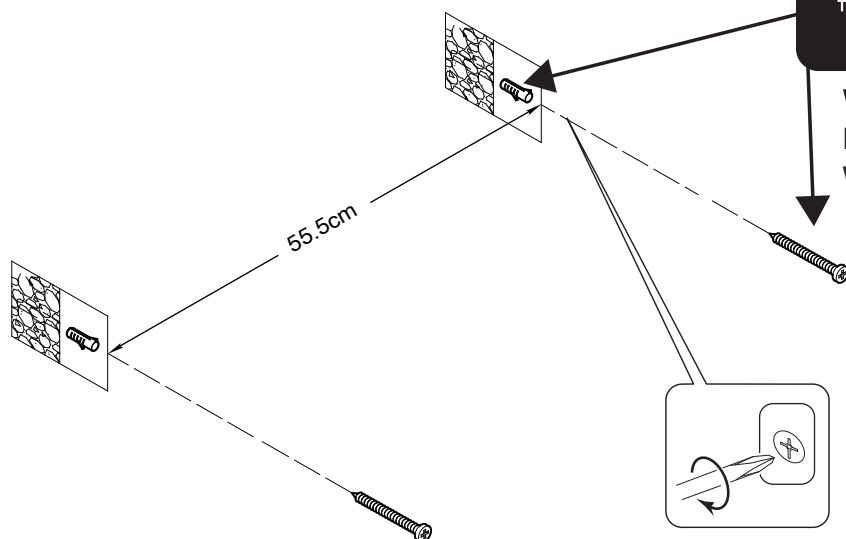

# 2

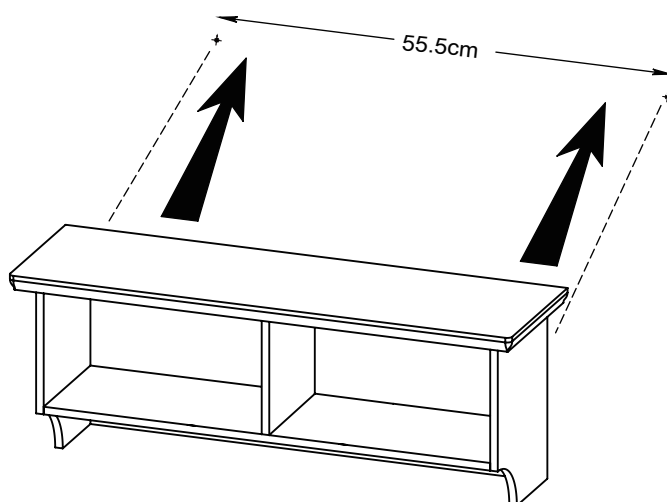

# 3

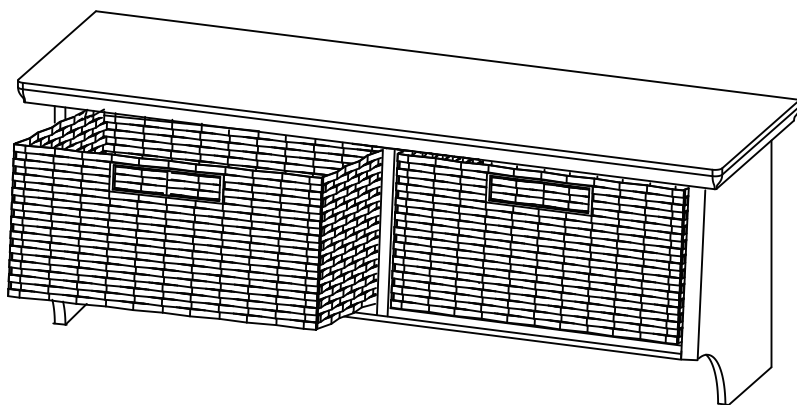

## A Guide to

# Wall Mounting & Fixings

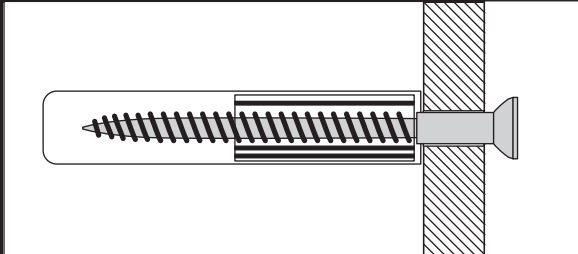

### IMPORTANT:

When drilling into walls always check that there are no hidden wires or pipes etc. Make sure that the screws and wall plugs being used are suitable for supporting your unit. Consult a qualified tradesperson if you are unsure.

### HINTS:

- 1) General Rule  Always use a larger screw and wall plug if you are not sure.
- 2) Ensure you use the recommended drill bit to match the wall plug and hole size.
- 3) Ensure you drill the hole horizontally, do not force the drill or enlarge the hole.
- 4) Take extra care when drilling high walls, ceilings and ceramic tiles. Ensure the plug is fitting below the ceramic tile to avoid splitting or cracking.
- 5) Ensure wall plugs are well fitted and are a tight fit in the drilled hole.

### Types Of Walls

You can use one of the following types of wall plug if your walls are made of brick, breeze block, concrete, stone, wood or plaster board.

#### No.1 "Standard" Wall Plug General Wall Materials

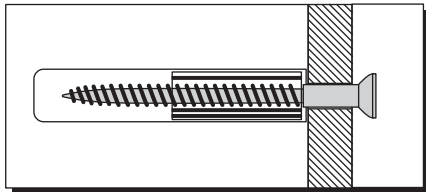

These come in various sizes and are made from plastic or sometimes wood fiber.

#### No.2 "General Purpose" Wall Plug Aerated / Breeze Block

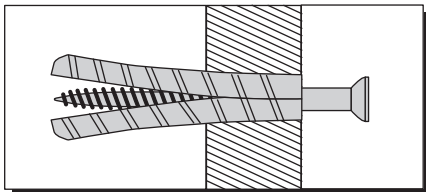

Generally aerated blocks should not be used to support heavy loads, use a specialist fitting in this case.

For light loads, a General Purpose Plug can be used.

#### No.3 "Shield Anchor" Wall Plug Heavy Loads

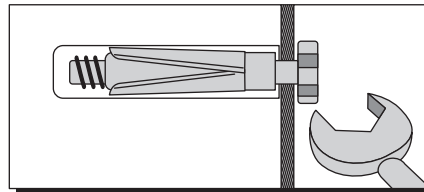

For use with heavier loads such as TV & HiFi Speakers and Satellite Dishes etc.

#### No.4 "Cavity Fixing" Wall Plug

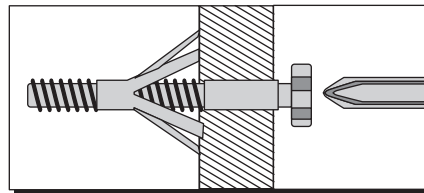

For use with plaster board partitions or hollow wooden doors.

#### No.5 "Cavity Fixing - Heavy Duty" Wall Plug

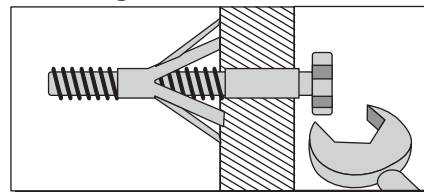

For use when fitting or supporting heavy loads such as shelving, wall cabinets, coat racks.

#### No.6 "Hammer Fixing" Wall Plug

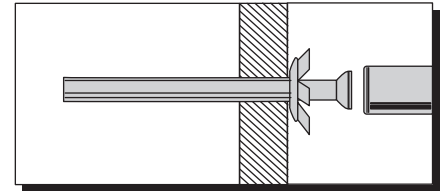

For use with walls stuck with plaster board. The hammer fixing allows it to be fixed to the wall rather than the plaster board. Always check the fixing is secure to the retaining wall.

### CARE & MAINTENANCE

#### SAFETY

Always check the fitting and location to ensure your safety in and around the home.

#### FITTING

From time to time check the fitting to ensure the wall plugs or screws do not become loose.