

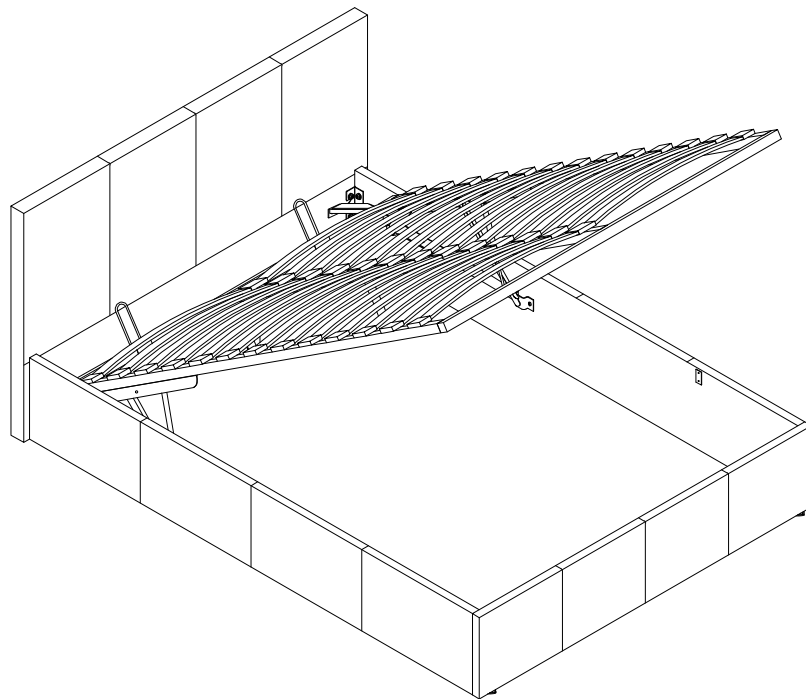

# Heathdon/ habitat

## Lavendon



### Spare Parts

 [www.argos-support.co.uk](http://www.argos-support.co.uk)

 [Help@ClickSpares.co.uk](mailto:Help@ClickSpares.co.uk)

 0370 112 1928

### Customer Support

 0345 640 2020



# Safety and Care Advice

## Product Details

4' Bed Grey Fabric 945/7276  
4' Bed Grey PU 952/3791  
4' Bed Black PU 945/0510

4'6 Bed Grey Fabric 953/6142  
4'6 Bed Grey PU 953/0083  
4'6 Bed Black PU 953/2160

5' Bed Grey Fabric 951/4212  
5' Bed Grey PU 948/2090  
5' Bed Black PU 952/3526

## IMPORTANT, RETAIN FOR FUTURE REFERENCE: READ CAREFULLY.

- Keep children and animals away from the work area, small parts could choke if swallowed.
- Make sure you have enough space to layout the parts before starting.
- This product has been constructed to be used in the domestic environment only and not for commercial purposes.

## Care and maintenance

- Only clean using a damp cloth and mild detergent. Do not use abrasive cleaners.
- Use a dry cloth to clean the product, furniture polish is not recommended.

- Assemble the item as close to its final position (in the same room) as possible.
- Assemble on a soft level surface to avoid damaging the unit or your floor.

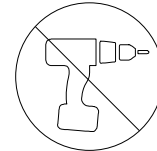

• We do not recommend the use of power drill/drivers for inserting screws as this could damage the unit. Only use hand screwdrivers.

• Parts of the assembly will be easier with 2 people.

• Dispose of all packaging carefully and responsibly.

- From time to time check that there are no loose screws, nuts or bolts. If there are please re-tighten.

• This product should not be discarded with household waste. Take to your local authority waste disposal centre.

## Important Ottoman Safety Warnings

- Caution. This bed uses a pressurised mechanism.
- Use caution when operating - Always use two hands at arm's length, and only where illustrated on the product.
- You must ensure the mattress is on the bed frame before lifting the mechanism - Failure to do so may result in injury.
- Please ensure Children and pets are kept away from the bed when operating the bed mechanism.
- If removing the mattress, make sure that the frame is secured as it could flip open.
- Only use the storage compartment when when the frame is fully raised in the 'up' position.
- No children or animals are left unattended when the frame is in the 'up' position.
- Do not remain on the bed whilst the lifting mechanism is in use.
- Beware of Entrapment - Keep both hands clear of mechanism when operating the mechanism.
- When lifting the bed remove all bedding - Except the fitted sheet.

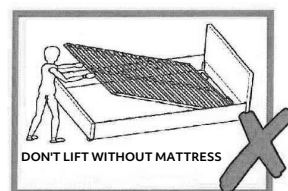

Sainsbury's Argos is a trading name of both: Argos Limited, Registered office: 489-499 Avebury Boulevard, Milton Keynes, United Kingdom, MK9 2NW, registered number: 01081551 (England and Wales); and Sainsbury's Supermarkets Limited, Registered office: 33 Holborn, London, EC1N 2HT, registered number: 03261722 (England and Wales). Both companies are subsidiaries of J Sainsbury's plc. Argos (N.I.) Ltd, Forestside Shopping Centre, Upper Galwally, Belfast, United Kingdom, BT8 6FX. Argos Distributors (Ireland) Limited, Unit7, Ashbourne Retail Park, Ballybin Road, Ashbourne, County Meath, Ireland.

# Fittings (Shown to scale)

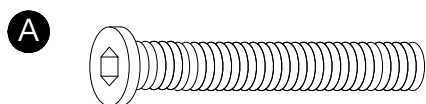

8x45mm Bolt x 6

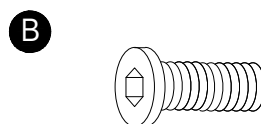

8x25mm Bolt x 50

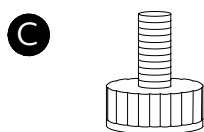

8mm Bolt x 4

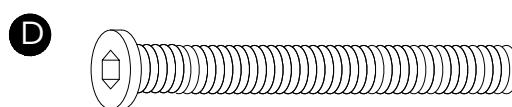

8x60mm Bolt x 2

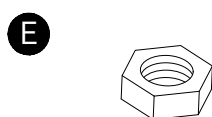

Nut x 6



17mm Flat washer x 58



12mm Spring washer x 34

**Note: All fittings packed inside the back of the headboard**

# Parts

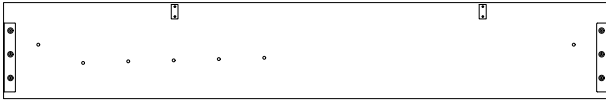

- 1 Right side rail x 1  
(4'-4'6-1930 x 305mm)(5'-2030 x 305mm)

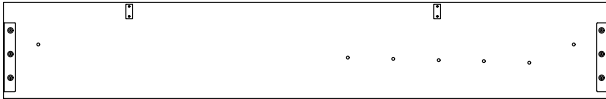

- 2 Left side rail x 1  
(4'-4'6-1930 x 305mm)(5'-2030 x 305mm)

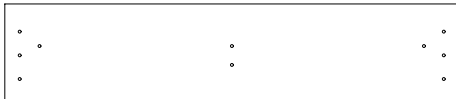

- 4 Footboard x1 (4'-1300 x 305mm)  
(4'6-1450 x 305mm)(5'-1600 x 305mm)  
**Note: Packed inside the back of the headboard**



- 6 Metal corner plate x 4 (169 x 35mm)  
**Note: Packed inside the back of the headboard**

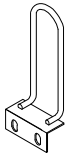

- 8 Mattress support bracket x 2  
**Note: Packed inside the back of the headboard**



- 10 Ottoman end frame (Footboard) x 1  
(4'-1213 x 85mm)(4'6-1363 x 85mm)  
(5'-1513 x 85mm)  
**Note: Packed inside the back of the headboard**

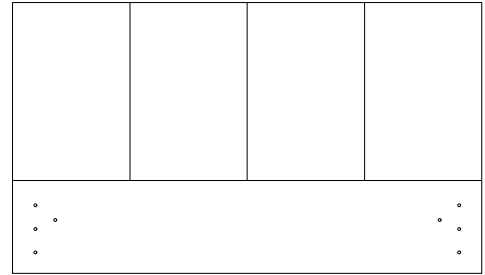

- 3 Headboard x1 (4'-1350 x 860mm)  
(4'6-1500 x 860mm)(5'-1650 x 860mm)

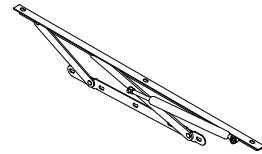

- 5 Hinge Mechanism (x 1 pair)  
NOTE: PISTON ATTACHED

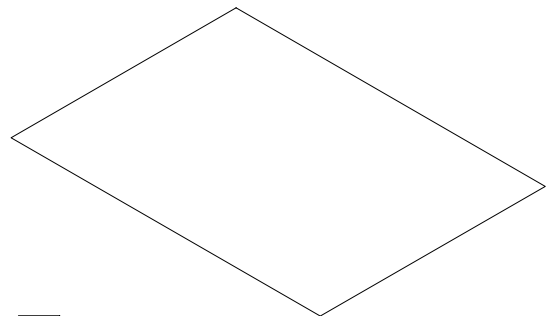

- 7 Fabric base x 1 (4'-1965 x 1280mm)  
(4'6-1965 x 1430mm)(5'-2065 x 1580mm)  
**Note: Packed inside the back of the headboard**

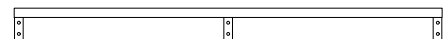

- 9 Ottoman end frame (Headboard) x 1  
(4'-1213 x 85mm)(4'6-1363 x 85mm)  
(5'-1513 x 85mm)  
NOTE: EXTRA HOLES  
**Note: Packed inside the back of the headboard**



- 11 Ottoman frame (Sides) x 2  
(4'-4'6-1822 x 30mm)(5'-1922 x 30mm)

# Parts

---



- 12 Ottoman frame centre support x 1  
(4'/4'6-1822 x 30mm)(5'-1922 x 30mm)

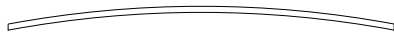

- 14 Bentwood slats x 28 (4'-598 x 9 x 53mm)  
Bentwood slats x 28 (4'6-675 x 9 x 53mm)  
Bentwood slats x 30 (5'-750 x 9 x 53mm)  
**Note: Packed inside the back of the headboard**

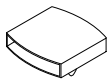

- 16 Double slat caps x 14 (4'-55mm)  
Double slat caps x 14 (4'6-55mm)  
Double slat caps x 15 (5'-55mm)  
**Note: Packed inside the back of the headboard**

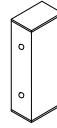

- 13 Ottoman frame support x 1  
(94 x 40mm)  
**Note: Packed inside the back of the headboard**



- 15 Single slat caps x 28 (4'-55mm)  
Single slat caps x 28 (4'6-55mm)  
Single slat caps x 30 (5'-55mm)  
**Note: Packed inside the back of the headboard**

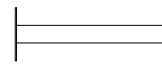

- 17 Support Leg x 2 (25 x 205mm)  
**Note: Packed inside the back of the headboard**

# Tools required

---

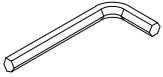

Allen key (Supplied)

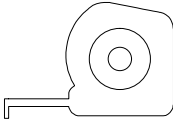

Ruler/tape measure

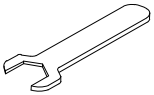

Spanner (Supplied)

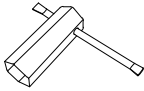

Box spanner (Supplied)

# 1

Components packed inside back of headboard

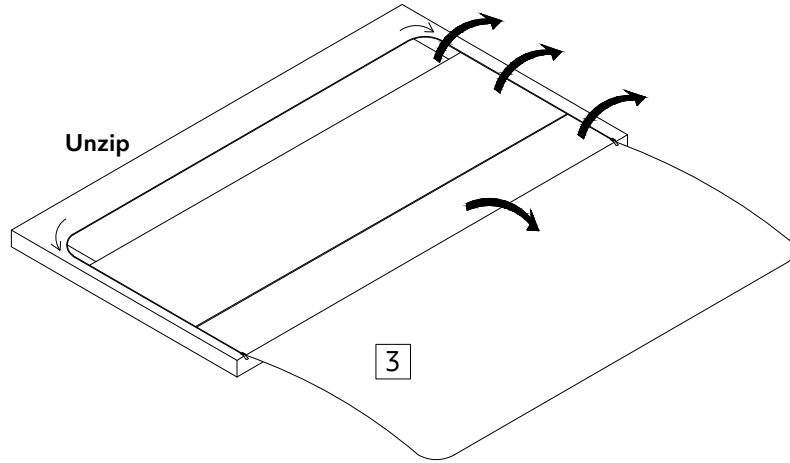

**WARNING!**  
The headboard is heavy.  
Lift with care.

Shown upside down

# 2

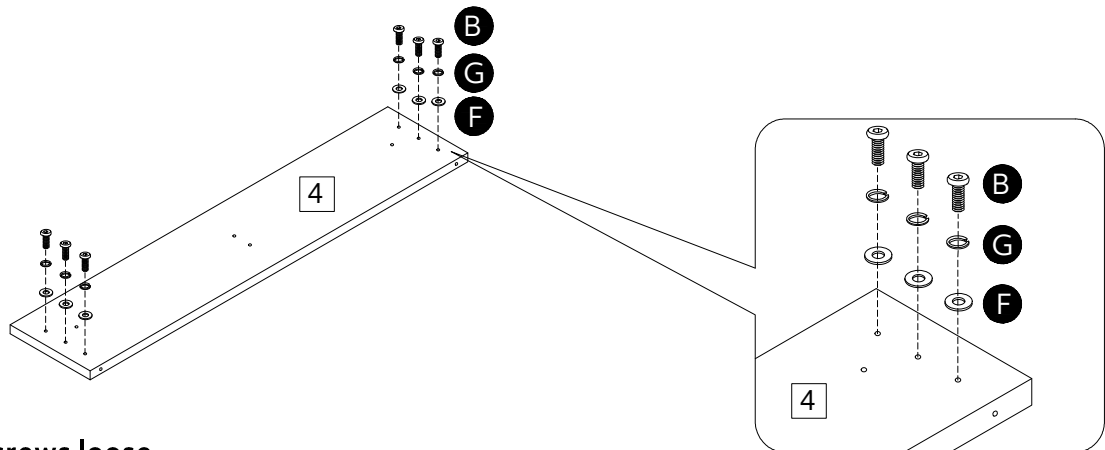
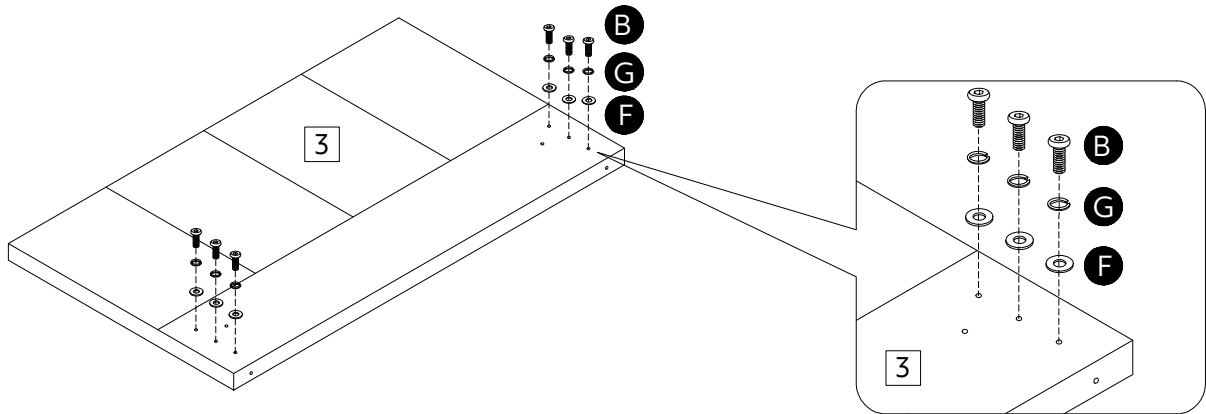
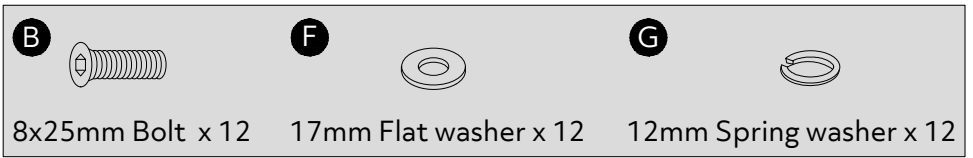
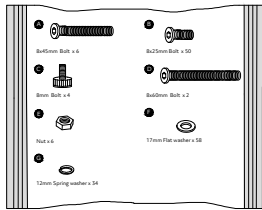

Leave screws loose

# 3

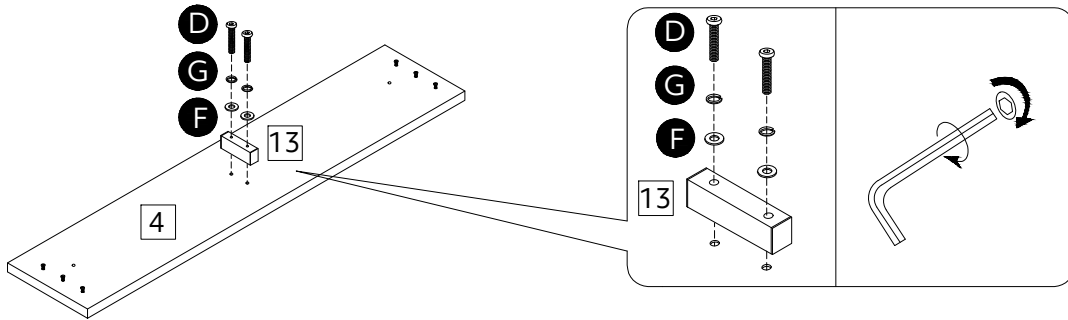
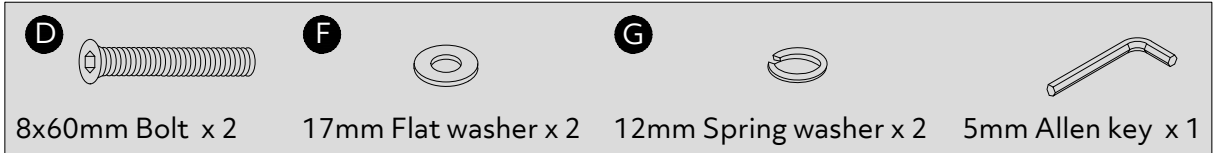

# 4

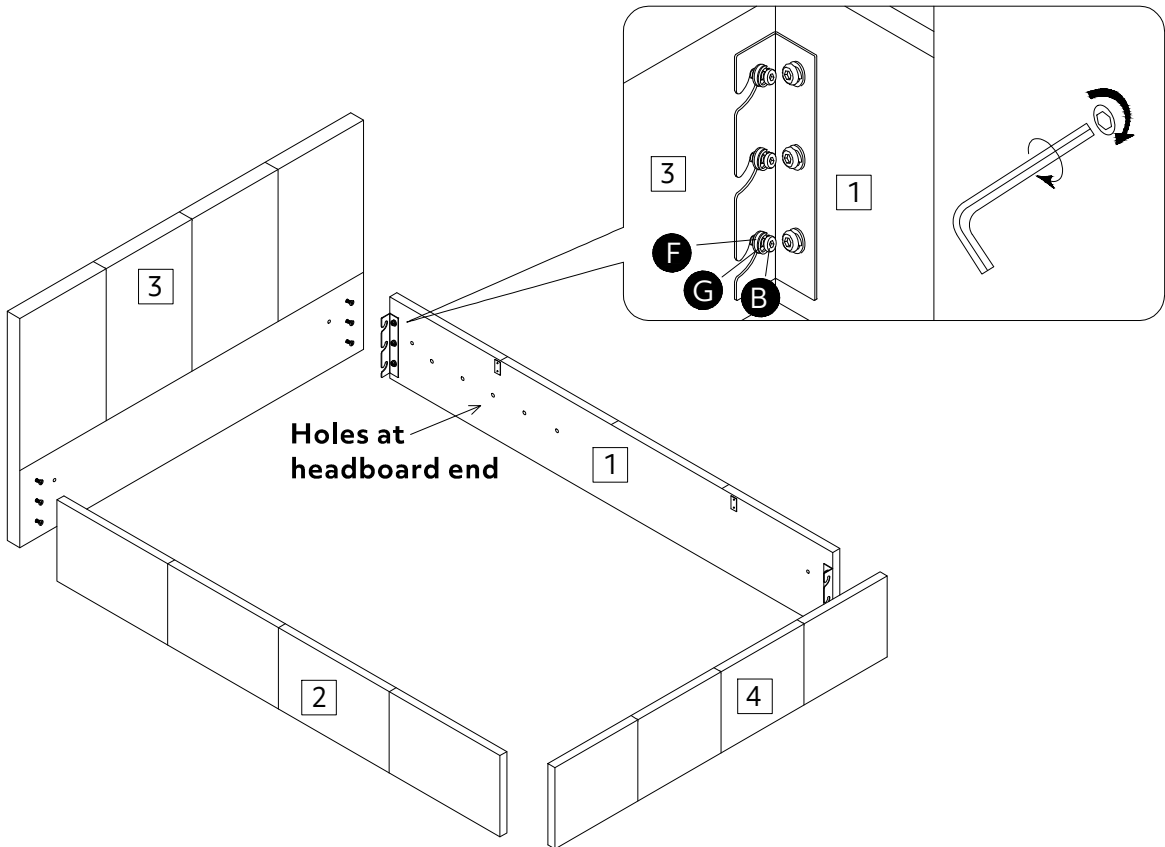

**Do not fully tighten fixings!**



# 5

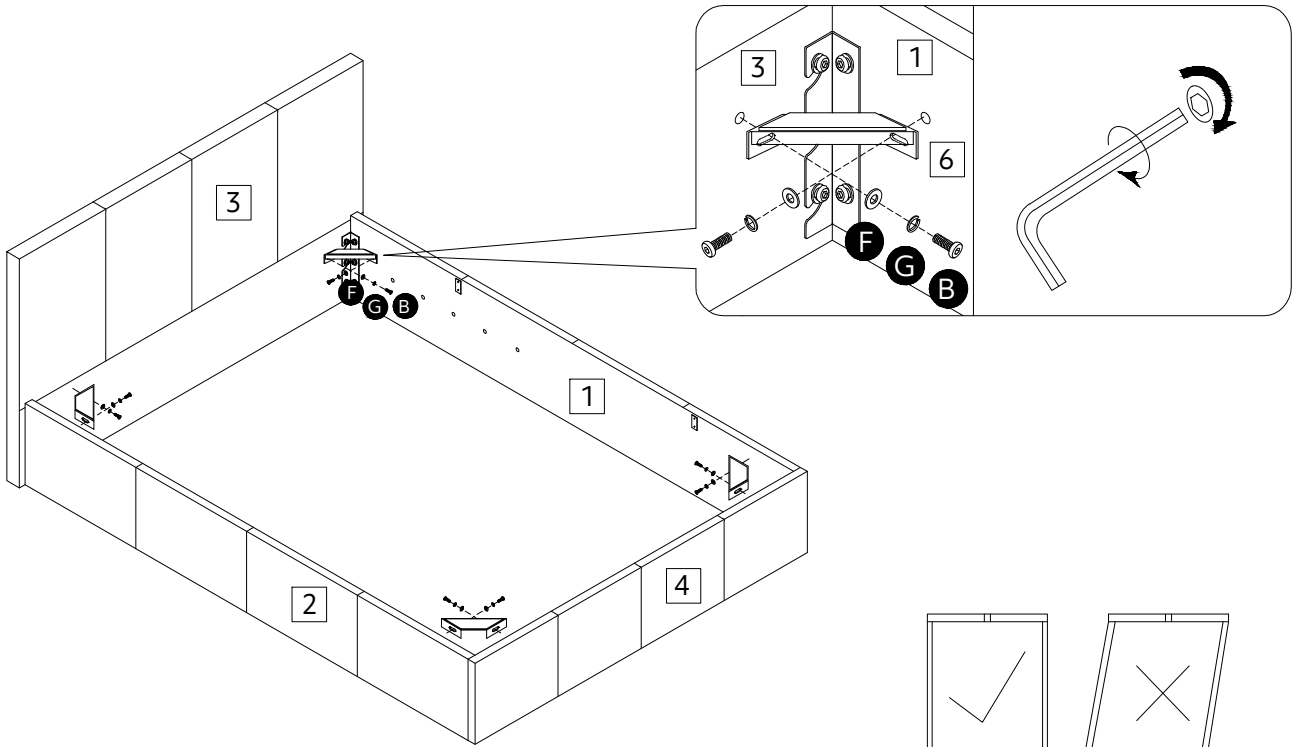

Ensure frame is square

# 6

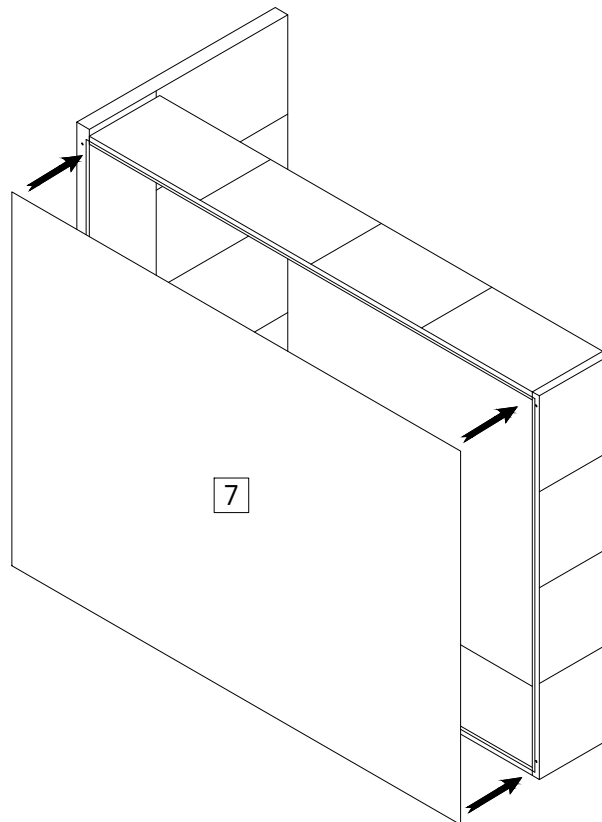

Velcro fastening

# 7

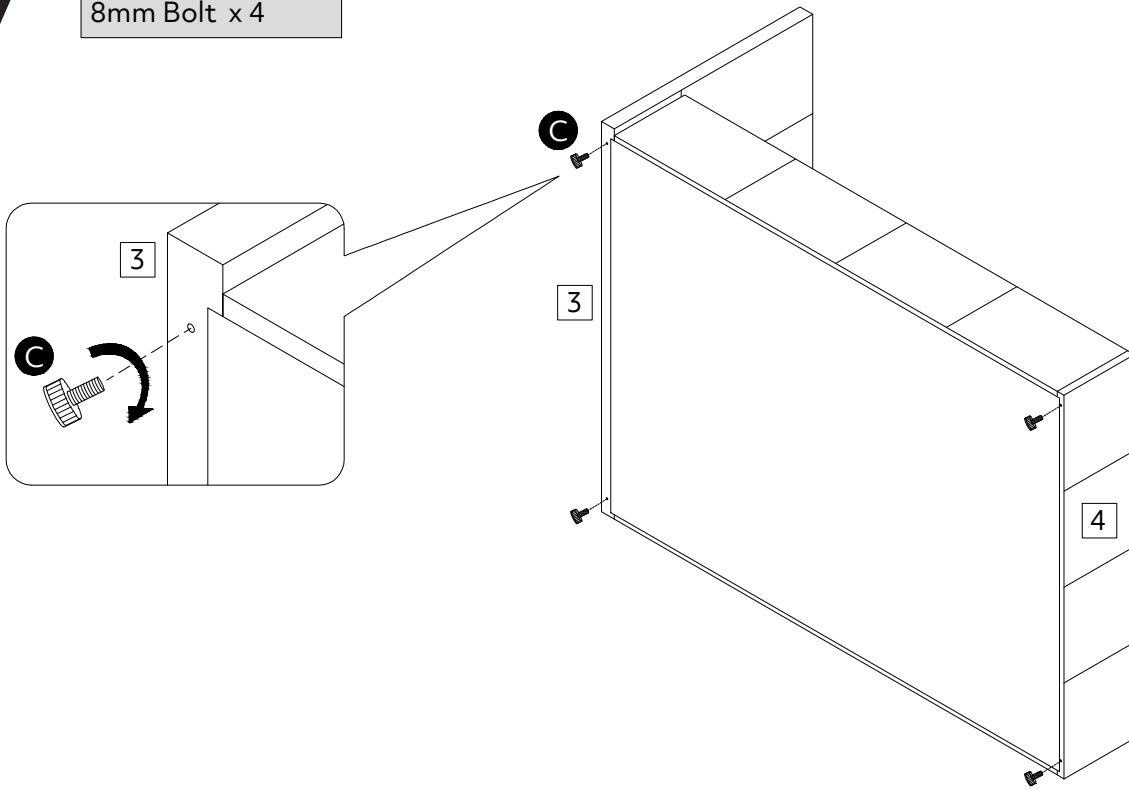
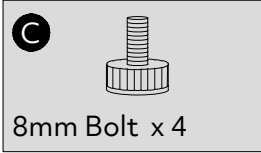

# 8

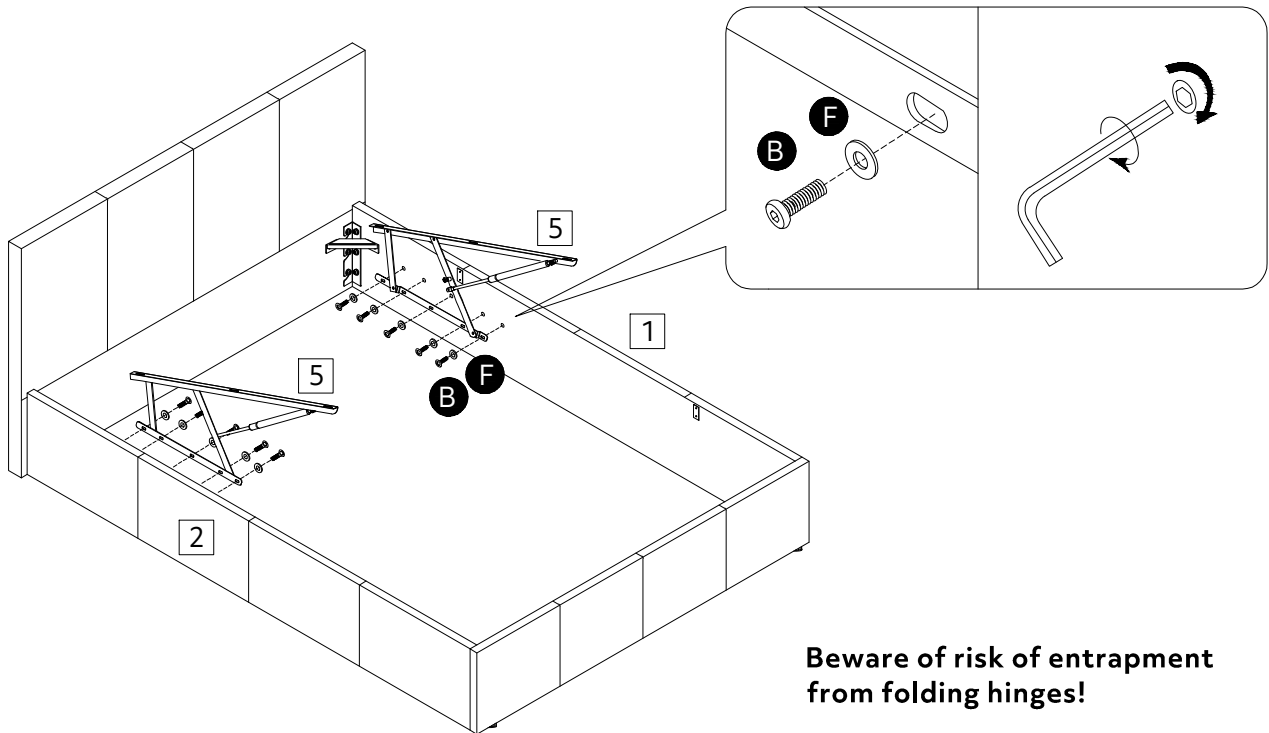
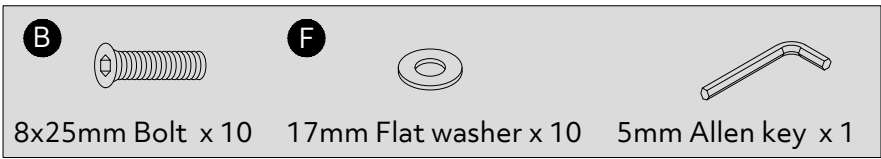



**Beware of risk of entrapment from folding hinges!**

# 9

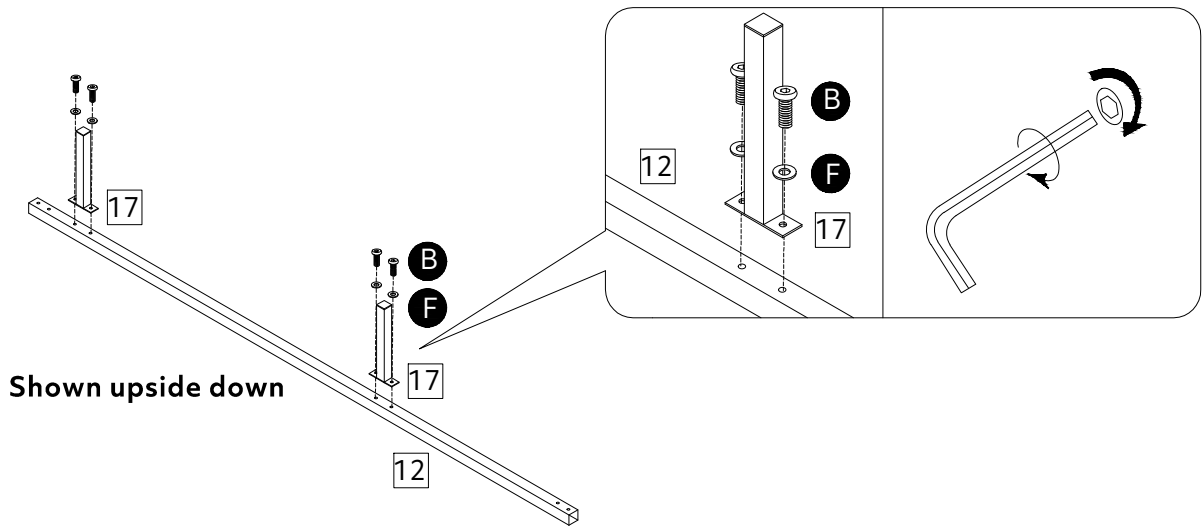
<b>B</b> 	<b>F</b> 	
8x25mm Bolt x 4	17mm Flat washer x 4	5mm Allen key x 1



# 10

<b>B</b> 	<b>F</b> 	<b>G</b> 
8x25mm Bolt x 12	17mm Flat washer x 12	12mm Spring washer x 12

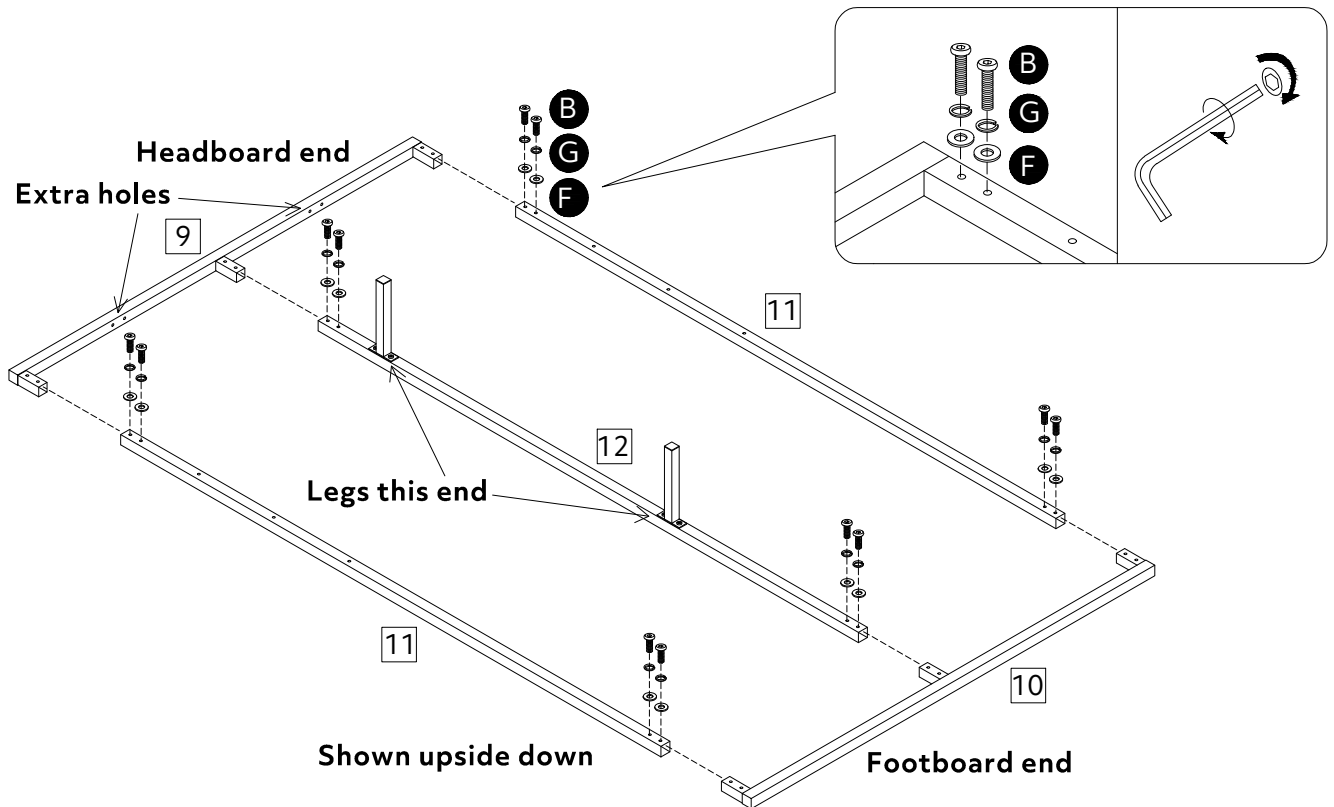

5mm Allen key x 1

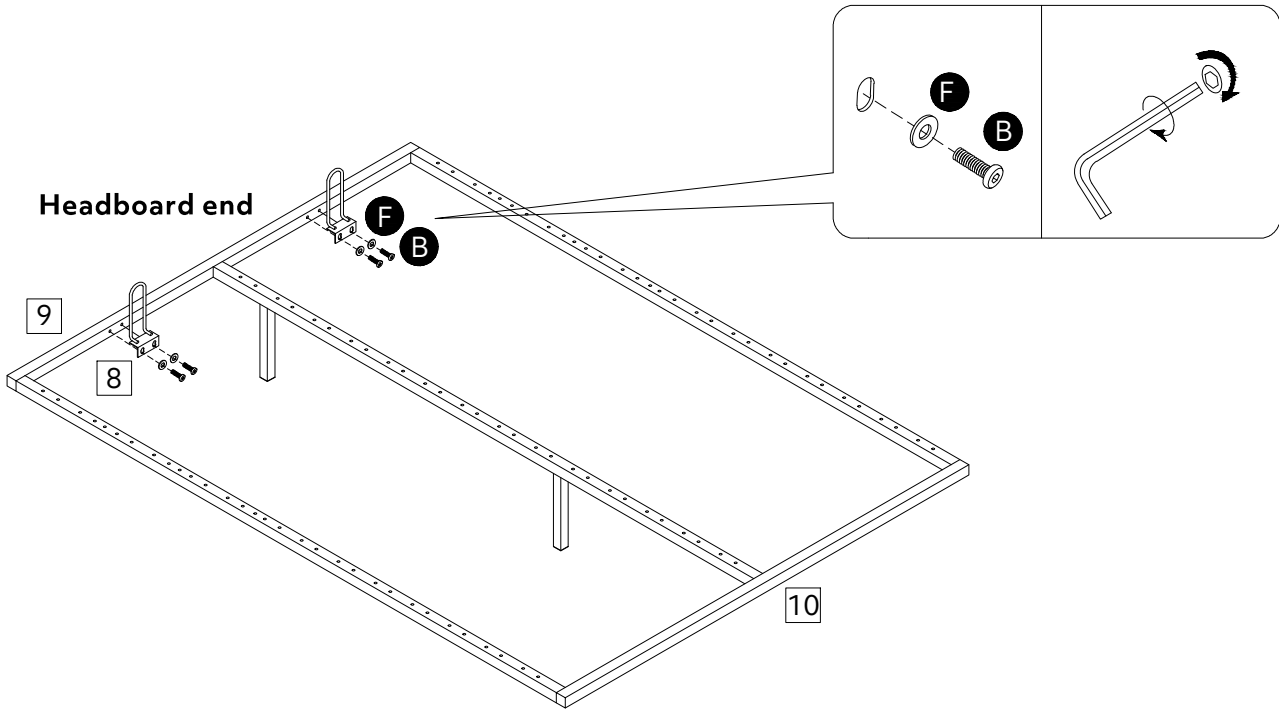
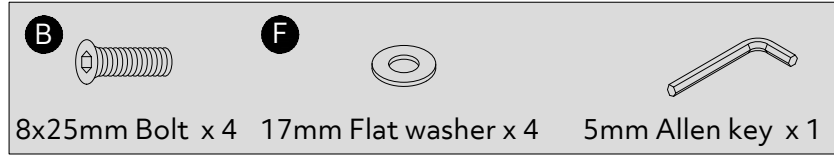

# 11

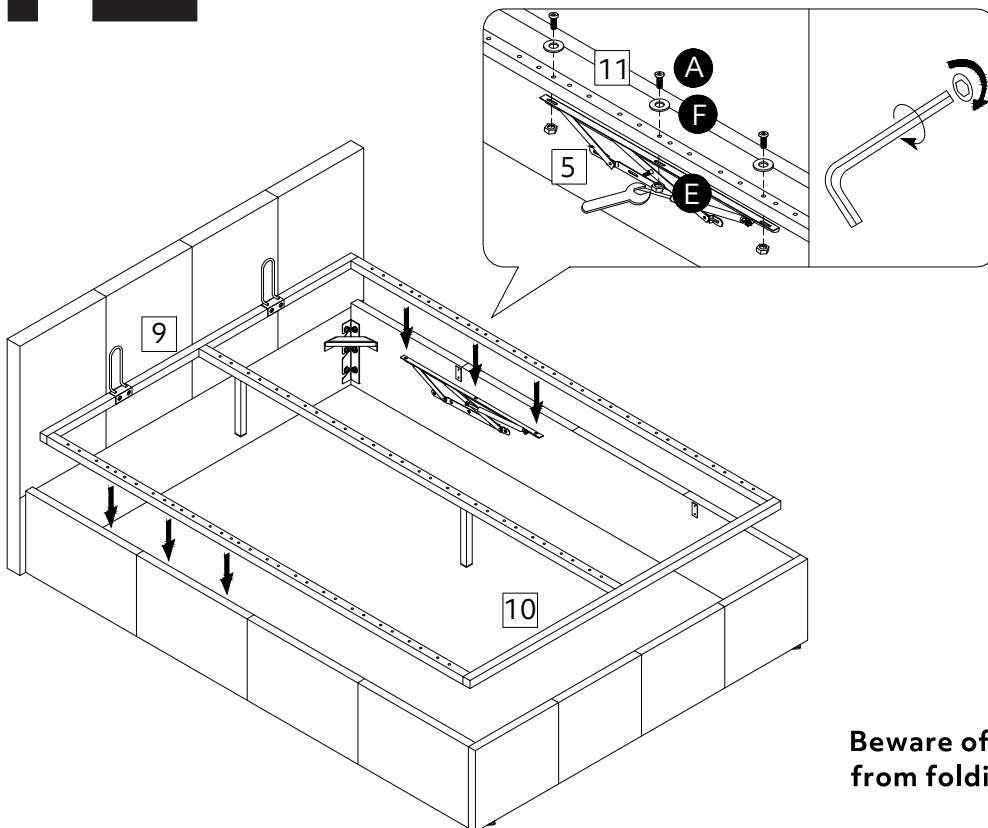
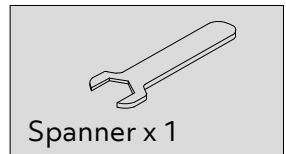
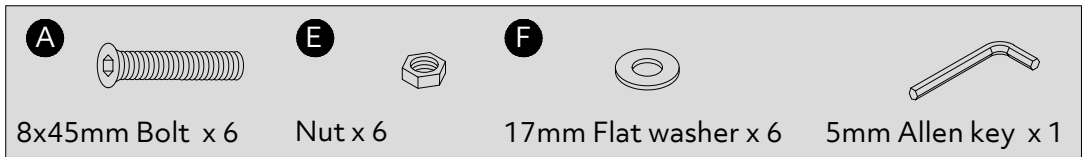

# 12



**Beware of risk of entrapment from folding hinges!**

# 13

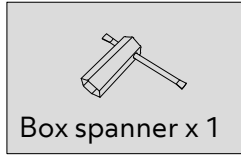

**Important:** Two people required.  
Frame to be fully supported at  
all times!

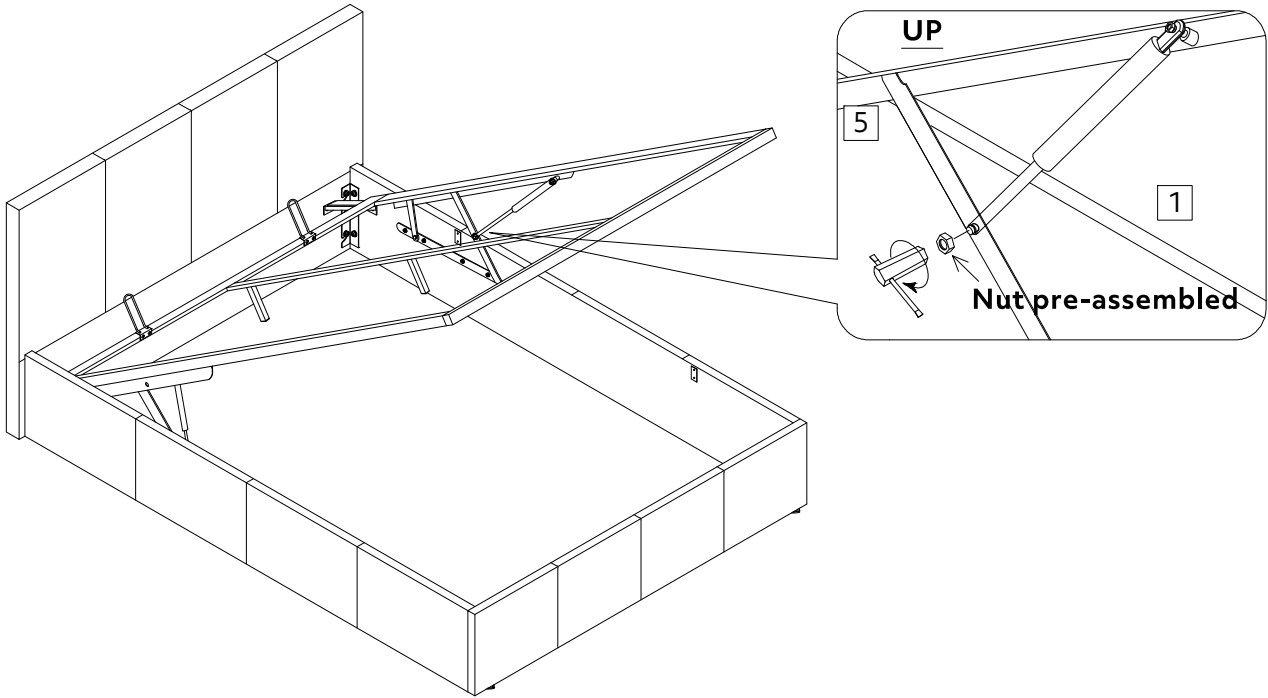

# 14

Repeat  
x14  
4'/4'6

Repeat  
x15  
5'

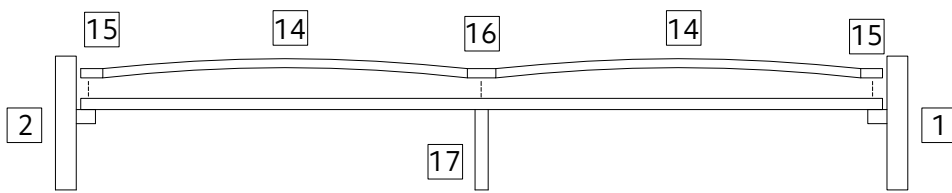
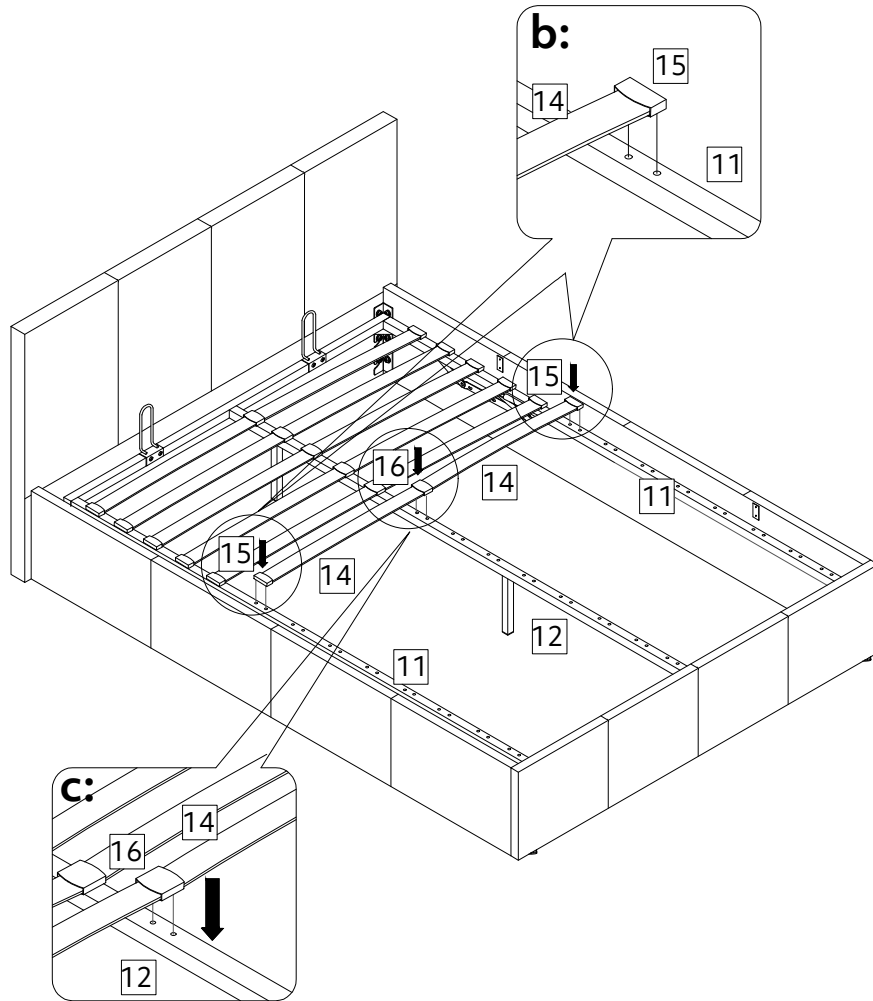
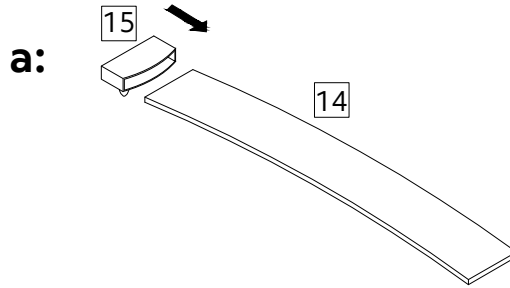

Slats to arch upwards