

## Health and Safety

The use of any electrical appliance requires the following common sense safety rules. Please read these instructions carefully before using the product.

- This appliance can be used by children aged from 8 years and above and persons with reduced physical, sensory or mental capabilities, or lack of experience and knowledge, if they have been given supervision or instruction concerning the use of the appliance in a safe way and understand the hazards involved.
- Children shall not play with the appliance.
- Cleaning and user maintenance shall not be made by children unless they are older than 8 years and supervised.
- Keep the appliance and its cord out of reach of children less than 8 years.
- If the supply cable is damaged, it must be replaced by the manufacturer, its service agent or similarly qualified persons in order to avoid a hazard.
- The bread may burn, therefore do not use the appliance near or below combustible material such as curtains.
- This appliance is not intended to be operated by means of an external timer or separate remote control system.

The use of any electrical appliance requires the following common sense safety rules.

**WARNING: Danger to the person!**

**IMPORTANT: Damage to the appliance!**

In addition, we offer the following safety advice.

### Location

- This appliance is intended to be used in household and similar applications such as:  
farm houses;  
by clients in hotels, motels and other residential type environments;  
bed and breakfast type environments.  
It is not suitable for use in staff kitchen areas in shops, offices and other working environments.

### Mains cable

- Do not let the cable run across a cooker or hot area which might damage the cable.

### Other safety considerations

- Only use for intended purpose.

### Personal safety

- Do watch your appliance during use.
- **WARNING:** Do not touch the top of the appliance or other hot parts during or after use, use handles or knobs.
- **WARNING:** Do not wrap the cable around the main body of the appliance during or after use.
- **WARNING:** Do not use under cupboards.
- **WARNING:** Do not insert oversize foods, metal, foil packages or utensils into the toaster.
- **WARNING:** Do not attempt to dislodge food when the appliance is plugged in and never insert cooking utensils into the slots.
- **WARNING:** Misuse of the appliance could cause personal injury.
- **IMPORTANT:** Do not place bread or other items on top of the slots as this may damage the appliance and creates a fire hazard.

### Precautions

- Never use the appliance when it is empty (when there is no bread inside) except on first use.
- Do not use very thin or broken slices of bread.
- Do not insert other foods that may drip during the cooking process. In addition to making the cleaning procedure more difficult, these may cause fires.
- Clean the crumb tray regularly: crumbs can smoke or burn.
- Do not insert (by force) foods that are too big for the slots.
- Do not insert forks or other utensils into the toaster in order to remove bread. As well as damaging the toaster, there is a high risk of electric shock.
- Should some toast remain blocked in the toaster, remove the plug from the mains, wait for the toaster to cool down until it is safe to touch, then turn the toaster over and shake it gently.

### Electrical requirements

Should the fuse in the mains plug require changing, a 13 amp BS1362 fuse must be fitted.

**WARNING: This appliance must be earthed.**



**CAUTION!**  
HOT SURFACE

**PLEASE BE AWARE  
OF HOT SURFACES  
HANDLE WITH CARE**  
**Treating scalds**

- Run cold water over the affected area immediately.
- Do not stop to remove clothing.
- Seek medical advice quickly.

TT220021 MUK Rev 1 02/17

## Your 1 year guarantee

It is important to retain the retailer's receipt as proof of purchase. Staple your receipt to this back cover for future reference.

Please quote the following information if the product develops a fault. These numbers can be found on the base of the product.

Model no.

Serial no.

All Morphy Richards products are individually tested before leaving the factory. In the unlikely event of any appliance proving to be faulty within 28 days of purchase, it should be returned to the place of purchase for it to be replaced.

If the fault develops after 28 days and within 12 months of original purchase, you should contact the Helpline number quoting Model number and Serial number on the product, or write to Morphy Richards at the address shown.

You may be asked to return a copy of proof of purchase.

Subject to the exclusions set out below (see Exclusions), the faulty appliance will then be repaired or replaced as appropriate and dispatched usually within 7 working days of receipt.

If, for any reason, this item is replaced or repaired during the 1 year guarantee period, the guarantee on the new item will be calculated from original purchase date. Therefore it is vital to retain your original till receipt or invoice to indicate the date of initial purchase.

To qualify for the 1 year guarantee, the appliance must have been used according to the instructions supplied. For example, crumb trays should have been emptied regularly.

## Exclusions

Morphy Richards shall not be liable to replace or repair the goods under the terms of the guarantee where:

- 1 The fault has been caused or is attributable to accidental use, misuse, negligent use or used contrary to the manufacturer's recommendations or where the fault has been caused by power surges or damage caused in transit.
- 2 The appliance has been used on a voltage supply other than that stamped on the products.
- 3 Repairs have been attempted by persons other than our service staff (or authorised dealer).
- 4 The appliance has been used for hire purposes or non domestic use.
- 5 The appliance is second hand.
- 6 Morphy Richards reserves the right not to carry out any type of servicing under the guarantee at its discretion
- 7 Plastic filters for all Morphy Richards kettles and coffee makers are not covered by the guarantee.
- 8 Batteries and damage from leakage are not covered by the guarantee.
  - This guarantee does not confer any rights other than those expressly set out above and does not cover any claims for consequential loss or damage. This guarantee is offered as an additional benefit and does not affect your statutory rights as a consumer. Morphy Richards products are intended for household use only. See usage limitations within the location safety instructions.

## Disclaimer

Morphy Richards has a policy of continuous improvement in product quality and design. The company, therefore reserves the right to change the specification of its models at any time.



For electrical products sold within the European Community. At the end of the electrical products useful life, it should not be disposed of with household waste.

Please recycle where facilities exist. Check with your Local Authority or retailer for recycling advice in your country

**IF YOU ARE HAVING A PROBLEM  
WITH ONE OF OUR PRODUCTS, CALL  
OUR HELPLINE:**

**UK: 0344 871 0944  
EIRE: 1800 409 119  
SPARES: 0344 873 0710**

**morphy richards**

The After Sales Division  
Morphy Richards Ltd  
Mexborough, South Yorkshire,  
England, S64 8AJ

Helplines (office hours)  
UK 0344 871 0944  
Spare Parts 0344 873 0710  
Republic of Ireland 1800 409 119  
www.morphyrichards.com



TT220021 MUK Rev 1

**morphyrichards®**  
smart ideas for your home



## Dimensions 2 Slice Toaster

 Please read and keep these instructions for future use

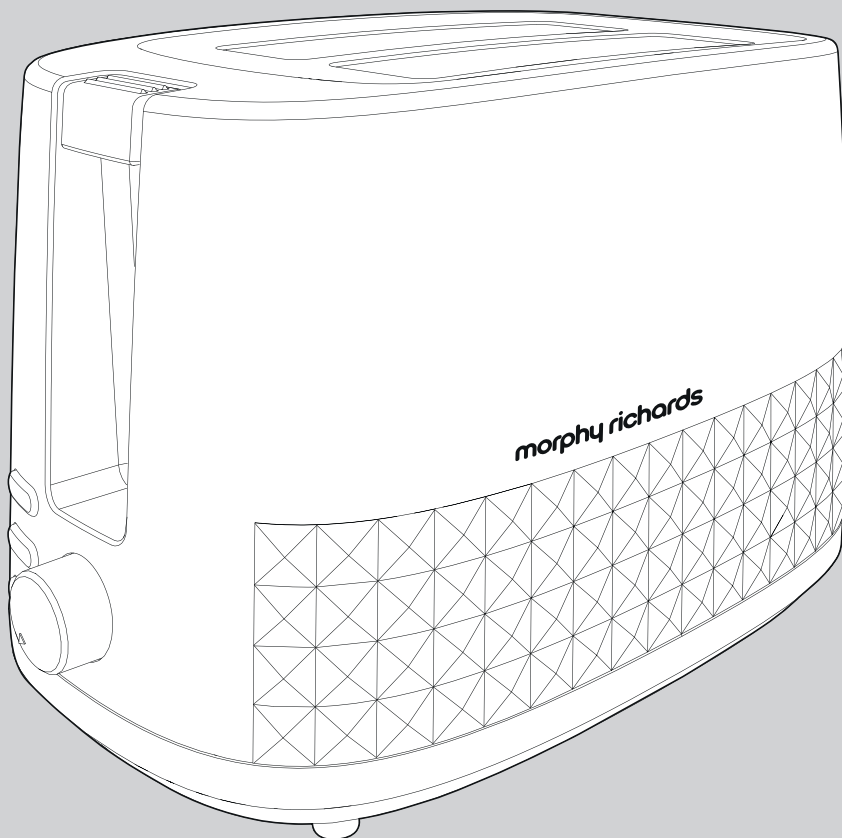

For competitions, product hints and tips  
and more join us at



[www.morphyrichards.co.uk/blog](http://www.morphyrichards.co.uk/blog)



[www.facebook.com/morphyrichardsuk](http://www.facebook.com/morphyrichardsuk)



[@loveyourmorphyrichards](https://twitter.com/loveyourmorphyrichards)

[www.morphyrichards.com](http://www.morphyrichards.com)

## Product overview

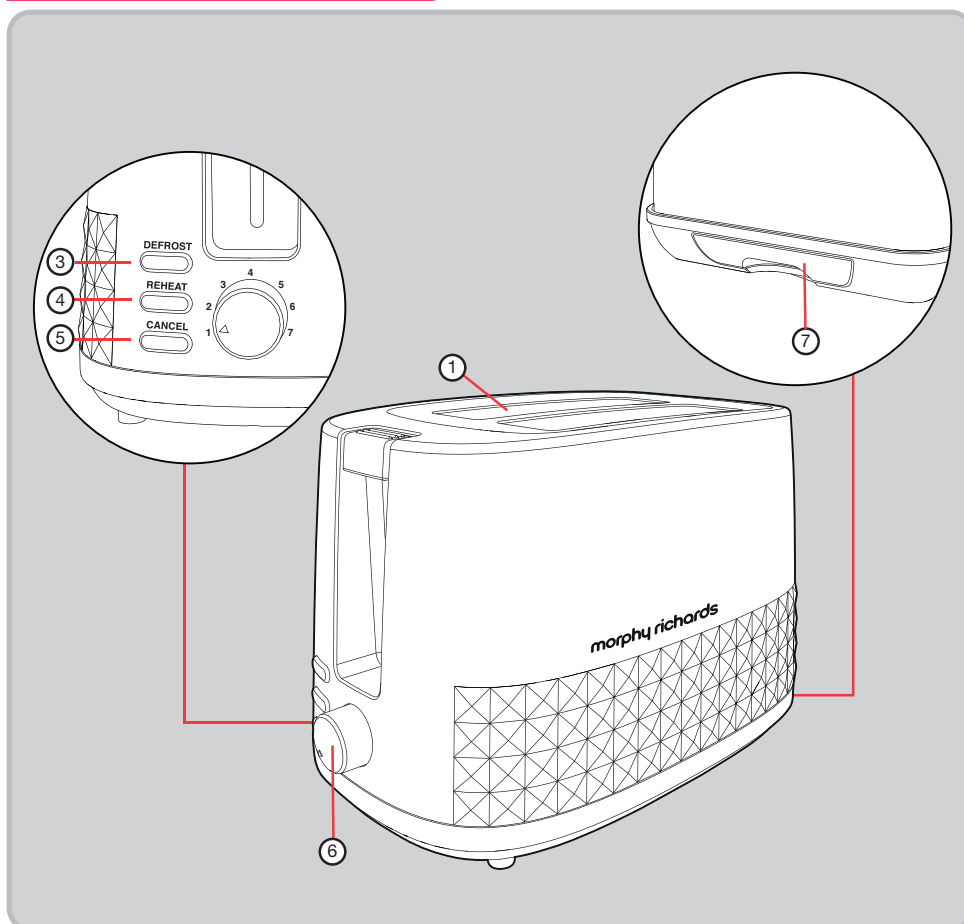

## Features

- (1) Bread Slots
- (2) Bread Carriage Lever
- (3) Defrost Button
- (4) Re-heat Button
- (5) Cancel Button
- (6) Browning Control
- (7) Crumb Tray (at rear)

## Before first use

- Before using your toaster for the first time, operate the toaster without bread.
- As with all new electric heating elements, your toaster will emit a 'new' smell when it is first switched on. This is quite normal and not a cause for concern.

## Using your toaster

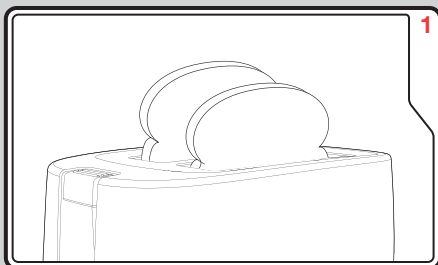

Place the sliced bread into the Bread Slots (1).

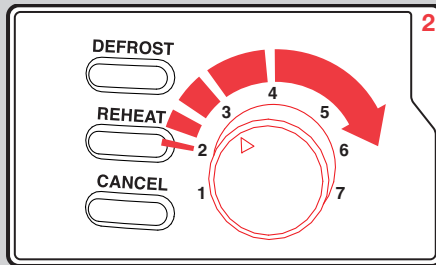

Adjust the Browning Control (6) to the desired setting.

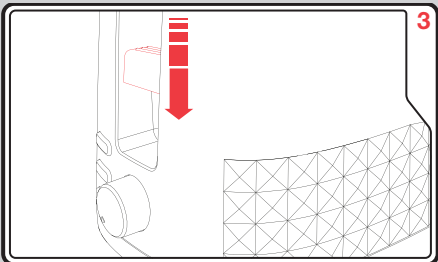

Depress the Bread Carriage Lever (2).  
The toaster will begin toasting the bread.

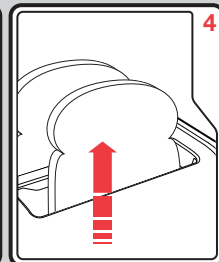
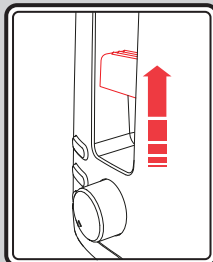

When completed, the Bread Carriage Lever will automatically rise and lift the toast from the toaster.

## Additional features

### Cancel Button

If you wish to interrupt the toasting process, press the Cancel Button (5).

### Re-heat Button

If your toast has popped up and gone cold, the toaster offers a re-heat facility. To use, depress the Bread Carriage Lever (2), and press the Re-heat Button (4) immediately. The button will illuminate and the toaster will operate for a short period reheating the bread.

### Frozen Button

To toast frozen bread, do not adjust the Browning Control (6) from your normal setting. Place the frozen bread in the Bread Slots (1), depress the Bread Carriage Lever (2) and press the Defrost Button (3). The button will illuminate and the toaster will operate for a longer period defrosting and toasting the bread.

## Removing the Crumb Tray

**WARNING:** Crumbs will accumulate in the Crumb Tray (7) and could catch fire if not emptied regularly.

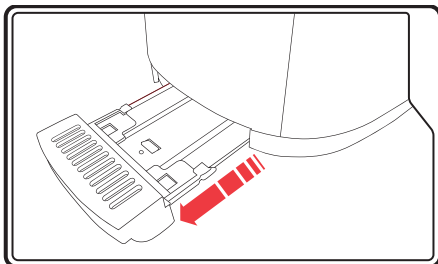

1. When the appliance has cooled down completely, tap the sides of the case lightly to dislodge any crumbs lodged in the Bread Slots (1).
2. Press the Crumb Tray to unlock and remove from the toaster.
3. Empty the Crumb Tray and replace, push to lock back into place.

Never operate the appliance without the Crumb Tray fitted.

## Hints and tips

- In order to achieve uniform browning, we recommend you wait a minimum of 30 seconds between each toasting, so that the control can be automatically reset.
- **If toasting one slice only, you may need to adjust the Browning Control (3) to a slightly lower setting. You will notice a variation in toast colour on one side of a single slice. The side facing the outside wall of the Bread Slot (1) will be darker in colour than the side facing the inner wall of the bread slot.**
- When toasting 2 slices it is recommended they are of equal size and freshness.
- Stale bread toasts more rapidly than fresh bread. Therefore, the Browning Control should be set at a lower setting than usual.
- All sorts of bread can be used as well as teacakes, small rolls etc. Slices should not however be so thick as to cause burning or jamming within the Bread Slots (1).
- If the bread in your toaster becomes jammed disconnect your toaster at the socket, allow it to cool, then remove the bread.

- Allow the toaster to cool fully before putting away.
- Should some toast remain blocked in the toaster, remove the plug from the mains, wait for the toaster to cool down until it is safe to touch, then turn the toaster over and shake it gently.

## Care and cleaning

- Before cleaning, unplug your toaster and let it cool down.
- The external part of the appliance must be cleaned with a soft cloth. Do not use abrasive detergents that can ruin the surface.
- **DO NOT IMMERSE IN WATER.**
- After each use, remove the plug from the electrical outlet and empty the crumb collection tray that is under the appliance.

**DO NOT TOUCH ANY PART OF THE TOASTER WITH SHARP OR METAL UTENSILS, ESPECIALLY INSIDE THE BREAD TOASTING SLOTS. RISK OF ELECTRIC SHOCK AND DAMAGE TO THE TOASTER.**

## Contact us

### Helpline

If you are having a problem with your appliance, please call our Helpline, as we are more likely to be able to help than the store you purchased the item from.

Please have the product name, model number and serial number to hand when you call to help us deal with your enquiry quicker.

UK Helpline: 0344 871 0944

IRE Helpline: 1800 409 119

Spares: 0344 873 0710

### Talk To Us

If you have any questions or comments, or want some great tips or recipe ideas to help you get the most out of your products, join us online:

Blog: [www.morphyrichards.co.uk/blog](http://www.morphyrichards.co.uk/blog)

Facebook: [www.facebook.com/morphyrichardsuk](http://www.facebook.com/morphyrichardsuk)

Twitter: @loveyourmorphy

Website: [www.morphyrichards.com](http://www.morphyrichards.com)