

www.avfgroup.com

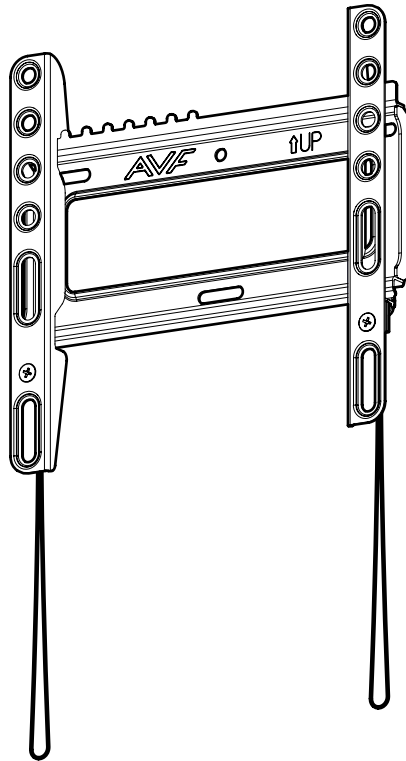

468256 rev01



20kg
44lbs

STOP

Read through **ALL** instructions before commencing installation.

If you have any questions about this product or issues with installation, contact the customer services help line before returning this product to the store.

**ARRETEZ
-VOUS**

Lisez **TOUTES** les instructions avant de débiter l'installation.

Si vous avez des questions sur ce produit ou des problèmes d'installation, contactez l'assistance client avant de ramener le produit en magasin.

ALTO

Lea **TODAS** las instrucciones antes de comenzar la instalación.

Si tiene alguna pregunta sobre el producto o problemas con la instalación, llame a la línea de servicio al consumidor antes de devolverlo.

CUSTOMER SERVICES HELP LINE NUMBER: **+44 (0) 333 320 0463 (UK)**
NUMÉRO DE L'ASSISTANCE CLIENT: **1-800 667 0808 (USA)**
NUMERO DE SERVICIO DE ATENCION AL CLIENTE: **1-800 667 0808 (USA)**

Assembly Overview
Vue d'ensemble de l'assemblage
Ensambladura General

Fit the TV Mounting Plate
Installer la plaque de montage
du téléviseur
Fije La Placa De Montaje De TV

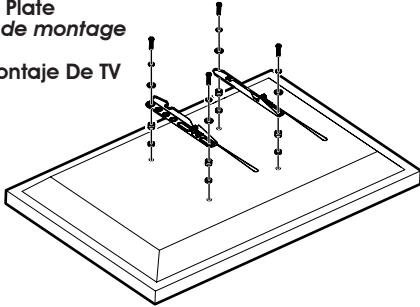

Fit the Wall Bracket
Fixer l'applique murale
Fije el Soporte de Pared

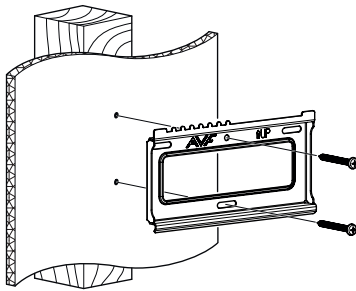

Connect the TV
Connecter le téléviseur
Conecte la TV

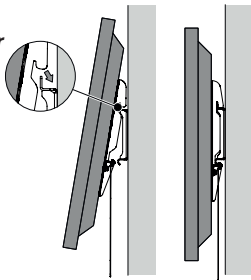

Suitable Wall Types
Types de murs appropriés
Tipos adecuados de pared

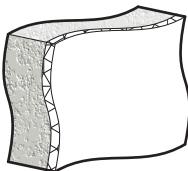

Solid Wall
Mur solide
Pared sólida

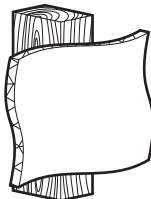

Wood Stud
Latte de bois
Viga de madera

Tools Recommended
Outils recommandés
Herramientas recomendadas



Stud Finder
Trouve latte
Detector de vigas
de madera

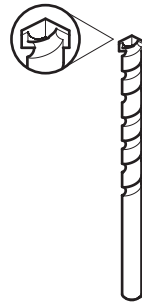

Ø8mm (5/16")
Masonry
Maçonnerie
Masoneria

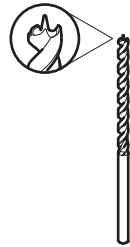

Ø3mm (1/8")
Wood
Bois
Madera

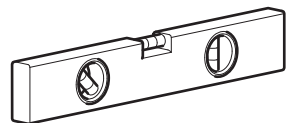
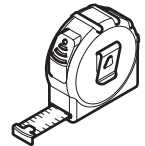
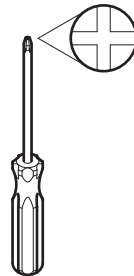
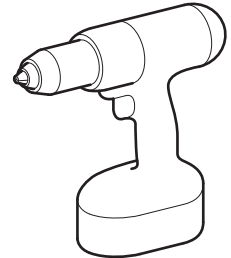

1 Measure the TV fixing holes Width and Height
Mesurer la profondeur et la taille des trous de fixation
Mida los orificios de su TV, lo ancho y lo alto

2 Fitting the TV Brackets
Montage des supports TV
Installer les supports muraux

3 Fitting the Wall Bracket
Installer l'applique murale
Fijando la Placa a la Pared

4 Connecting the TV
Connecter le téléviseur
Conectando la TV

5 To Remove the TV
Pour enlever le téléviseur
Para quitar la TV

Retain all packaging in case the bracket needs to be returned.

Contents may vary from photography/illustrations.

You will not need all these parts, so expect there to be some left over depending upon the specification of your TV.

This product is intended for indoor use only. Use of this product outdoors could lead to failure and personal injury.

It is the responsibility of the installer to ensure that the mounting wall is of a suitable standard and void of any services (eg gas, electricity, water etc).

AVF accept no responsibility for any damage or loss caused by installing this product in a sub standard wall.

Conserver les emballages si l'applique a besoin d'être ramenée.

Les contenus peuvent varier de la photographie/illustrations.

Vous n'aurez pas besoin de toutes ces pièces, attendez-vous donc à ce qu'il reste des pièces selon les caractéristiques de votre téléviseur.

Ce produit est à utiliser à l'intérieur uniquement. Utiliser ce produit à l'extérieur causera des défaillances et de possibles accidents.

Il est de la responsabilité de l'installateur de s'assurer que les murs soient aux critères requis et vides de tout câblage (ex : gaz, électricité, eau etc...)

AVF n'acceptera aucune responsabilité pour tout dommage ou perte causée par l'installation du produit dans un mur en deçà de ces critères.

Conserve todos los envasados en caso de que el soporte tenga que ser devuelto.

El contenido puede variar de la fotografía/ilustración.

No necesitará todas estas partes, espere que sobren algunas según las especificaciones de su TV.

Este producto está diseñado para el uso en el interior solamente. El uso de este producto en el exterior podría llevar al fracaso y lesiones personales.

Es la responsabilidad del instalador de asegurarse de que la pared de montaje es de un nivel adecuado y carece de todo los servicios (gas, electricidad, agua, etc.).

AVF no acepta ninguna responsabilidad por cualquier daño o pérdida causada por la instalación de este producto en una pared inadecuada.

Boxed Parts
Pièces empaquetées
Piezas en la Caja

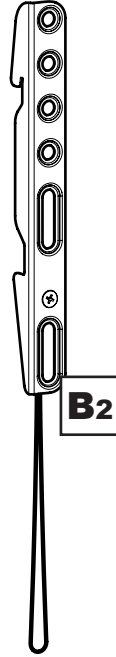
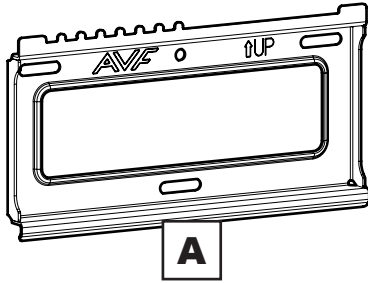
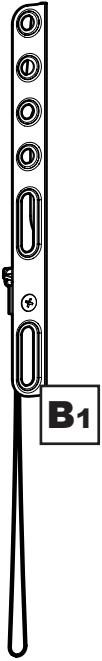

TV Screws, Reducers and Spacers
Vis TV, réducteurs et séparateurs
Tornillos, Reductores y Espaciadores para TV

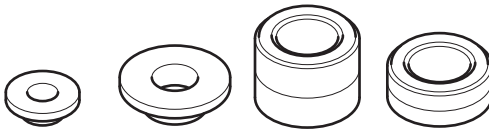

C1 x4 **C2** x4 **D1** x4 **D2** x4

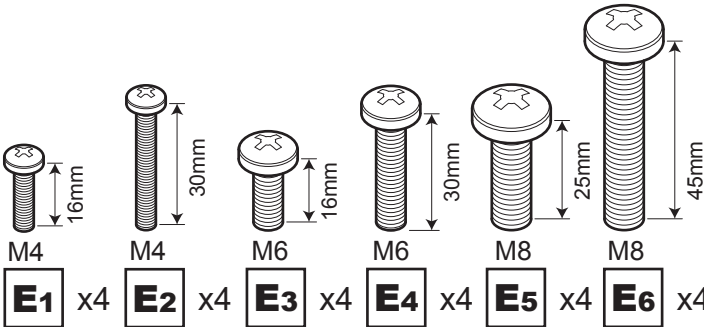

E1 x4 **E2** x4 **E3** x4 **E4** x4 **E5** x4 **E6** x4

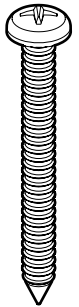

F x3

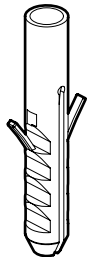

G x3

1

Measure the TV fixing holes Width and Height
 Mesurer la profondeur et la taille des trous de fixation
 Mida los orificios de su TV, lo ancho y lo alto

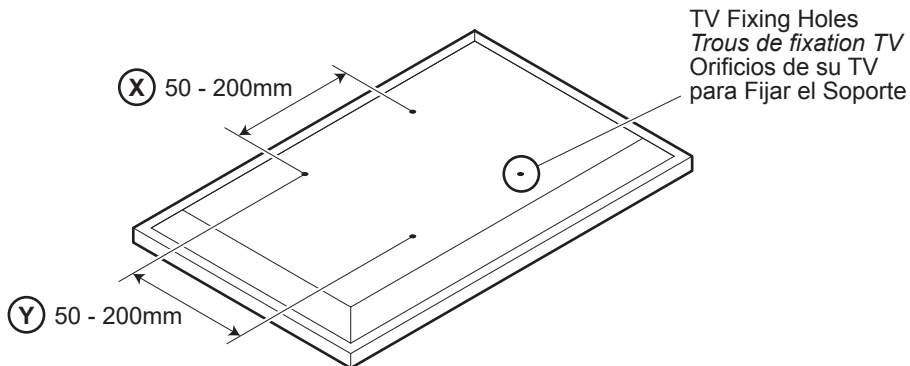

If width (X) is greater than 200mm or height (Y) greater than 200mm
 STOP installation now and contact the customer help line



*Si la largeur (X) est plus large que 200mm et la hauteur (Y) plus grande que 200mm,
 ARRÊTEZ l'installation immédiatement et contactez l'assistance client*

Si la anchura (X) es mayor que 200mm o la altura de (Y) es mayor que 200mm
 DETENGA la instalación inmediatamente y póngase en contacto con la línea de
 ayuda al cliente

You are provided with 3 diameters of TV fixing screws, **M4**, **M6** and **M8**.
 Determine the screw diameter that fits and remember for step 2.

*3 diamètres de vis TV vous sont fournis, **M4**, **M6** et **M8**.
 Déterminez le diamètre de la vis qui convient et mémorisez- le pour l'étape 2.*

Se le proporciona con 3 diámetros de tornillos de fijación para su TV: **M4**, **M6** y **M8**.
 Determine el diámetro del tornillo que le quede a su TV y recuérdelo para el paso 2.

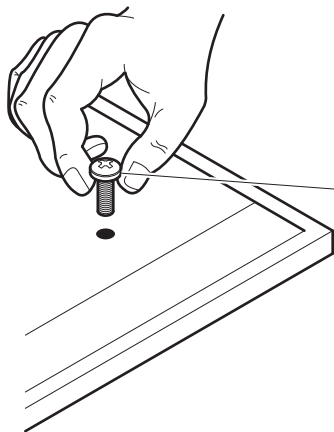

M4 = E1/E2

M6 = E3/E4

M8 = E5/E6

2

Fitting the TV Brackets Montage des supports TV Instalar los supports muraux

No Spacers Pas de séparateur Sin espaciadores

For TVs with flat / unobstructed back
*Pour des téléviseurs aux dos
plats et non obstrués*
Para TVs con la parte posterior
plana / sin obstáculos

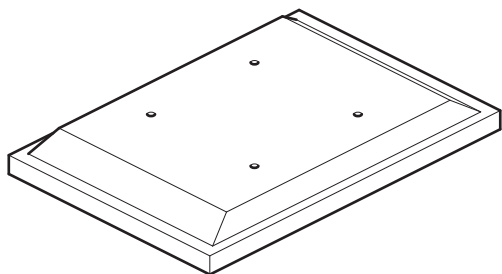

Spacers Séparateurs Espaciadores

D1/D2

For TVs with irregular / obstructed back
*Pour des téléviseurs aux dos
irréguliers et non obstrués*
Para TVs con la parte posterior
irregular / con obstáculos

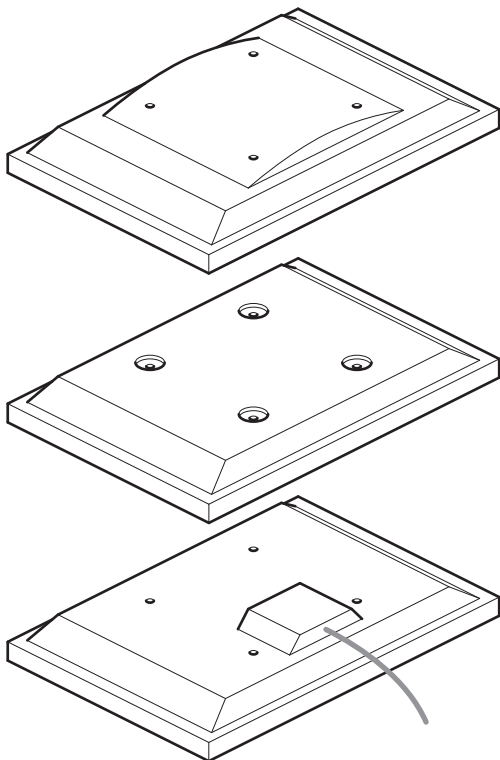

WARNING / AVERTISSEMENT / ADVERTENCIA

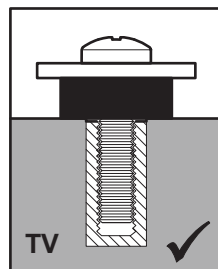
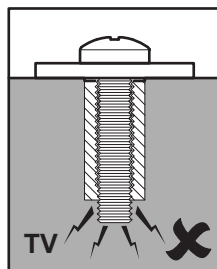
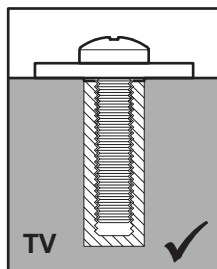
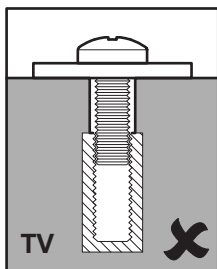

After completing step 2 you will have fittings left over, please keep for future reference.
Après avoir complété l'étape 2 il vous restera des pièces d'assemblage, conservez-les.
Después de completar el paso 2 usted tendrá conexiones sobrantes, por favor guarde
para futura referencia.

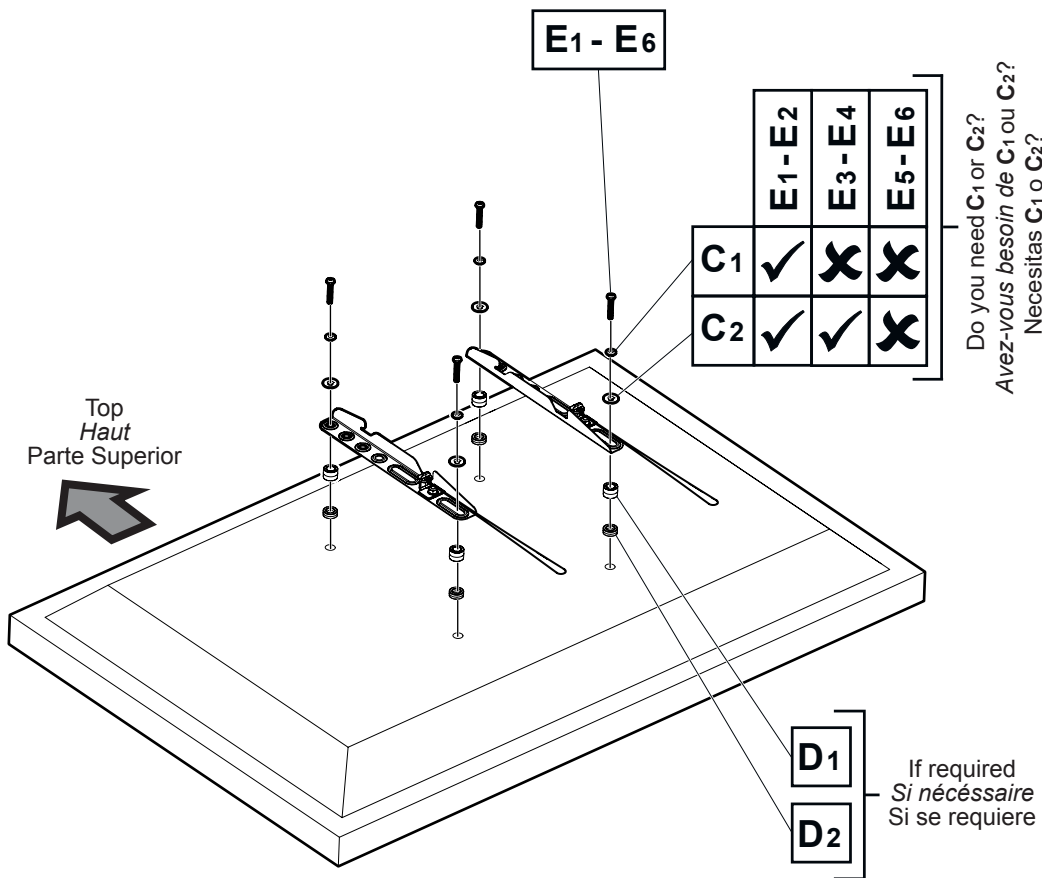

Attach the bracket to the back of your TV using suitable screw, reducer and spacer combinations.
Attachez l'applique au dos de votre téléviseur en utilisant une combinaison de vis, de séparateurs et de joints adaptés.

Coloque los soportes a la parte posterior de su TV usando la combinación adecuada de tornillo, reductor y espaciador.

Solid Wall / Mur solide / Pared sólida

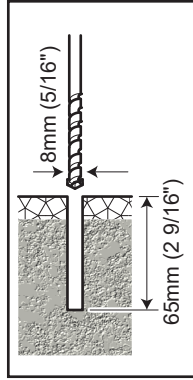
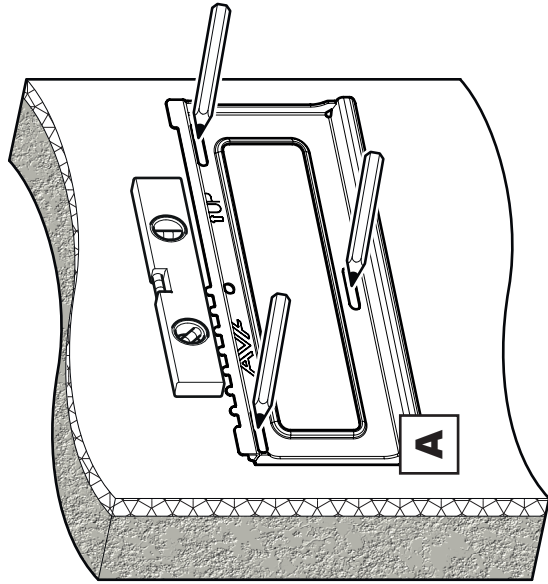

Remove Dust from Hole
 Retirez la poussière du trou
 Elimine el polvo del agujero

Wood Stud / Latte de bois / Viga de madera

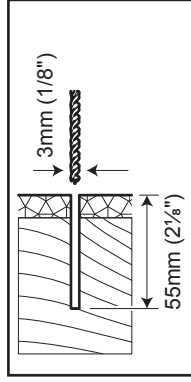
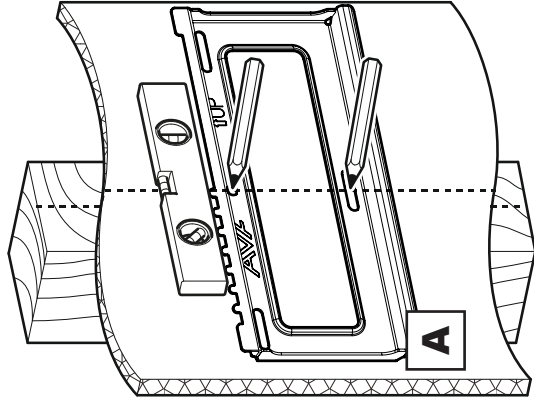
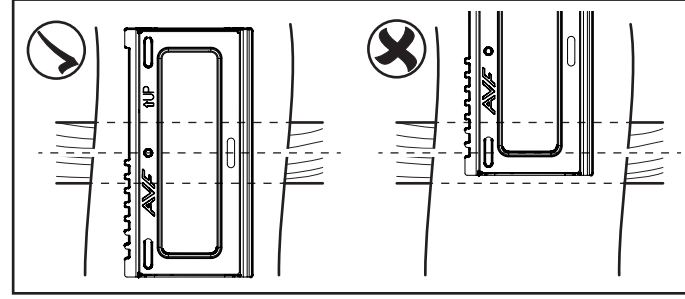

Ensure drill marks are in the centre of the wood stud
 S'assurer que les marques de perçage sont situées
 au centre des colombages de bois
 Asegúrese de que las marcas del taladrado estén
 en el centro de los pernos de madera



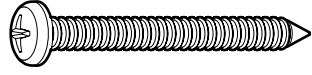
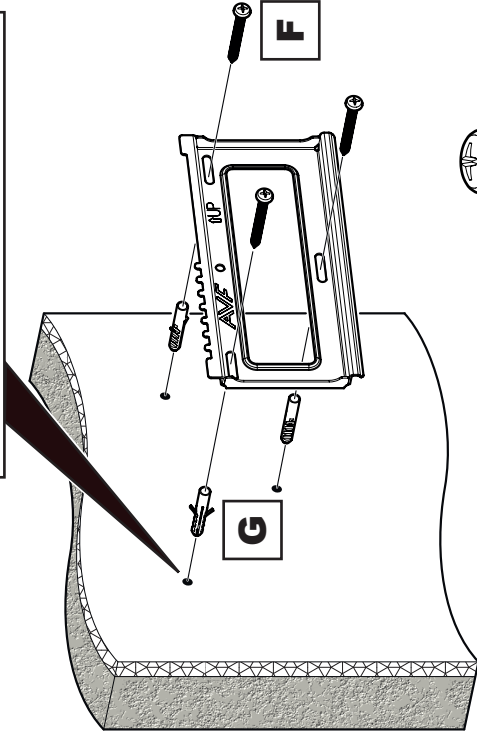
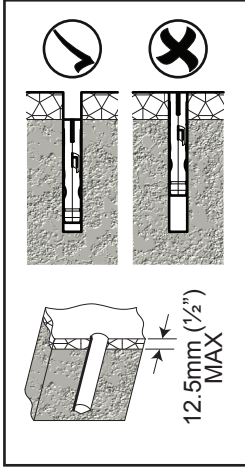

F x3

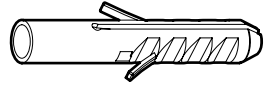

G x3



Lubricate screw thread with soap
Lubrifiez le pas de vis avec du savon
Lubrique la rosca del tornillo con jabón

DO NOT overtighten screws.
Tighten screws by hand only
Ne serrez pas trop les vis.
Visser à la main seulement
NO sobre apriete los tornillos.
Apriete los tornillos sólo a mano

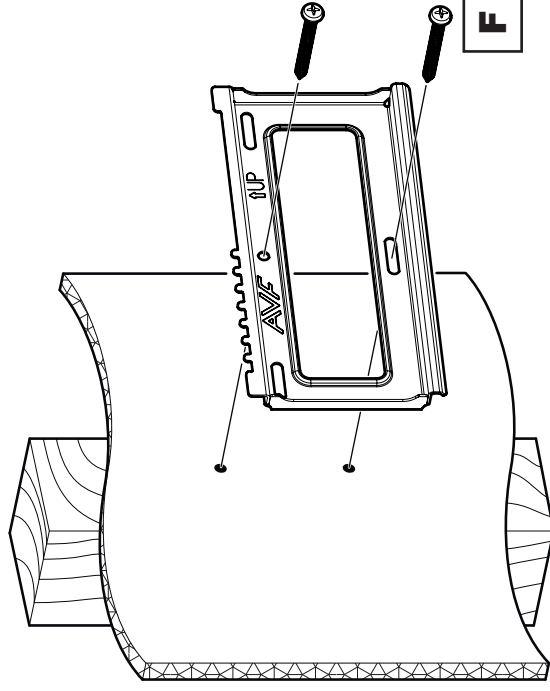

F x2



Lubricate screw thread with soap
Lubrifiez le pas de vis avec du savon
Lubrique la rosca del tornillo con jabón

DO NOT overtighten screws.
Tighten screws by hand only
Ne serrez pas trop les vis.
Visser à la main seulement
NO sobre apriete los tornillos.
Apriete los tornillos sólo a mano



4

Connecting the TV
Connecter le téléviseur
Conectando la TV

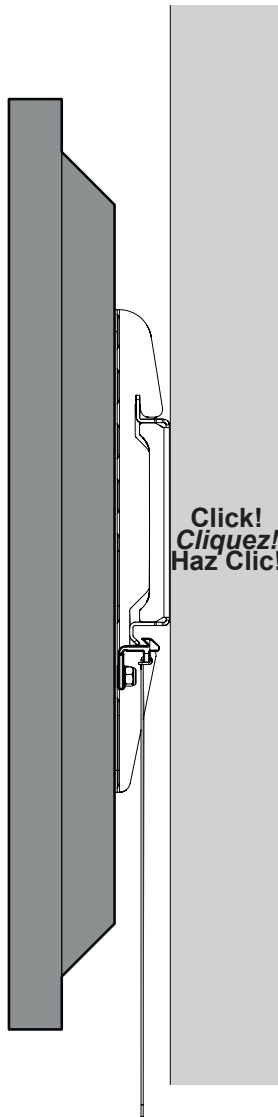
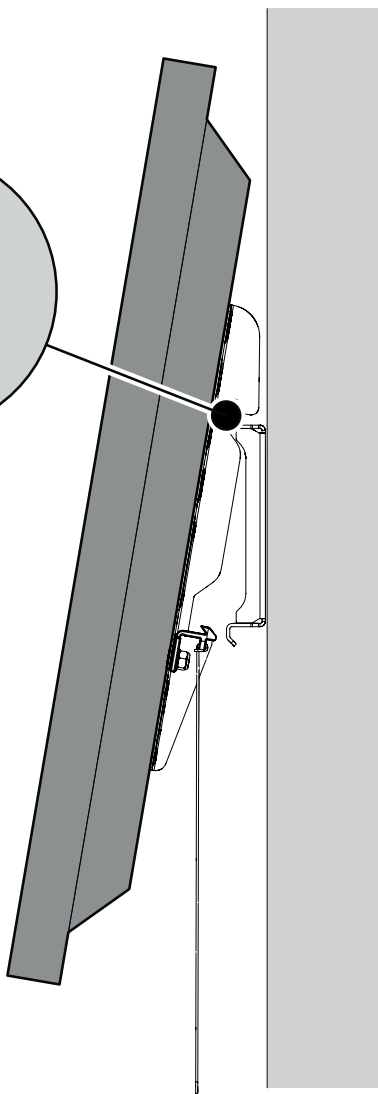
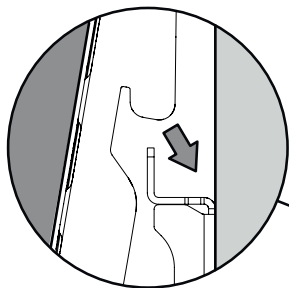

Click!
 Cliquez!
Haz Clic!

5

To Remove the TV
Pour enlever le téléviseur
Para quitar la TV

