



**SPEAR &  
JACKSON**

# ORIGINAL INSTRUCTION MANUAL

**350W**

# Electric Grass Trimmer

**S3525ET**



**Important - Please read these instructions  
fully before starting assembly**

These instructions contain important information that will help you get the best from your trimmer, ensuring it is assembled correctly and safely. If you need help or have damaged or missing parts, call the Customer Helpline on 0345 605 2067

**AFTER SALES SUPPORT  
0345 605 2067**

# SPEAR & JACKSON SINCE 1760

---

For more than 250 years gardeners have enjoyed high quality performance and great results using Spear & Jackson tools.

Our garden power tools combine continuous innovation and the latest in manufacturing technologies with a proud heritage.

Each product is carefully designed with performance, comfort and durability firmly in mind, which has earned Spear & Jackson an enviable reputation as a maker of tools to trust.

## 3 YEARS GUARANTEE

As a testament to the quality of our products, we offer a 3 year manufacturers warranty and a comprehensive after sales service.

The warranty covers manufacturing faults, however in the event that the item has been deliberately damaged, used in a commercial environment or disassembled then the warranty will be null and void.

Please retain proof of purchase.

## 7 DAYS A WEEK TECHNICAL SUPPORT

We want you to get the best out of your products. Our easy-to-read instruction manual guides you with best practice use and maintenance tips. Please call **0345 605 2067** for technical support, we can solve around 80% of questions directly over the phone.

We hope you enjoy your product and we look forward to any feedback, as this allows us to develop even better products for the future.

# CONTENTS

<b>Safety Information</b> .....	<b>04</b>
Description of symbols .....	04
General safety .....	05
Safety warnings .....	05
Personal safety .....	07
Operational safety .....	08
Maintenance and storage safety .....	10
Intended use .....	11
<b>Box Content / Parts</b> .....	<b>12</b>
<b>Assemble</b> .....	<b>13</b>
Safety guard Assemble .....	13
Front handle assemble .....	13
Plant protector assemble .....	13
Cord strain relief .....	14
<b>Operation</b> .....	<b>15</b>
General operation .....	15
Height adjustment .....	15
Handle adjustment .....	15
Tilt adjustment .....	16
Edging .....	16
Automatic line feeding .....	16
Plant protector .....	17
Switching on/off .....	17
Trimming .....	17
Tips .....	19
<b>Maintenance</b> .....	<b>20</b>
Replacing the spool .....	20
Winding the line .....	20
Storage .....	21
Transportation .....	21
After use .....	22
Recycling and disposal .....	22
<b>Technical Data</b> .....	<b>23</b>
<b>Troubleshooting</b> .....	<b>25</b>
<b>Warranty</b> .....	<b>26</b>

# SAFETY INFORMATION

Please read these instructions fully before operating or maintaining your machine

## DESCRIPTION OF SYMBOLS

The following warning symbols appear throughout this manual and indicate the appropriate safety measures you should take when operating and maintaining the grass trimmer.



### IMPORTANT!

Please read all of the safety and operating instructions carefully before using this tool. Please pay particular attention to all sections of this user guide that carry warning symbols and notices.



### WARNING!

This is a warning symbol. This symbol is used throughout the user guide whenever there is a risk of personal injury. Ensure that these warnings are read and understood at all times.



**Wear eye and ear protections.**



Disconnect the mains plug immediately if the cable is damaged, has been badly twisted or is completely cut through and in the event that the device is left unattended for a short time.



Guaranteed sound power level.



Warning! Cutting device continues to rotate after the motor is switched off.



Objects thrown by the product could hit the user or other bystanders. Always ensure that other people and pets remain at a safe distance from the product when it is in operation. In general, children must not come near the area where the product is.



Do not expose the product to rain or wet conditions (moisture).



Warning! Keep other people out of working area during operation. A distance of at least 15 m must be observed.



**Double insulations, Class II appliance.**



**Waste Disposal and Environmental Protection!**

Be environmentally friendly. Return the tool, accessories and packaging to a recycling centre when you have finished with them.

Electrical machines do not belong in domestic waste.

Take the equipment to a waste disposal site. The plastic and metal parts that are used can be separated out into pure grade, which allows recycling.



Confirms to all relevant safety standards.

# SAFETY INFORMATION

Please read these instructions fully before operating or maintaining your machine

## GENERAL SAFETY



### IMPORTANT!

- Keep this instruction manual in a safe place for future reference.
- Read the instructions carefully. Be familiar with the controls and the proper use of the equipment.
- Never use the machine while people, especially children, or pets are nearby. Keep in mind that the operator or user is responsible for accidents or hazards occurring to other people or their property.
- This appliance is not intended for use by persons (including children) with reduced physical, sensory or mental capabilities, or lack of experience and knowledge, unless they have been given supervision or instruction concerning use of the

appliance by a person responsible for their safety.

- Children should be supervised to ensure that they do not play with the appliance.

## SAFETY WARNINGS

### WORK AREA SAFETY

- Keep work area clean and well lit. Cluttered or dark areas invite accidents.
- Do not operate power tools in explosive atmospheres, such as in the presence of flammable liquids, gases or dust. Power tools create sparks which may ignite the dust or fumes.
- Keep children and bystanders away while operating a power tool. Distractions can cause you to lose control.

# SAFETY INFORMATION

Please read these instructions fully before operating or maintaining your machine

## ELECTRICAL SAFETY

- Power tool plugs must match the outlet. Never modify the plug in any way. Do not use any adapter plugs with earthed (grounded) power tools. Unmodified plugs and matching outlets will reduce risk of electric shock.
- Avoid body contact with earthed or grounded surfaces, such as pipes, radiators, ranges and refrigerators. There is an increased risk of electric shock if your body is earthed or grounded.
- Do not expose power tools to rain or wet conditions. Water entering a power tool will increase the risk of electric shock.
- Do not abuse the cord. Never use the cord for carrying, pulling or unplugging the power tool. Keep cord away from heat, oil, sharp edges or moving parts. Damaged or

entangled cords increase the risk of electric shock.

- When operating a power tool outdoors, use an extension cord suitable for outdoor use. Use of a cord suitable for outdoor use reduces the risk of electric shock.
- If operating a power tool in a damp location is unavoidable, use a residual current device (RCD) protected supply. Use of an RCD reduces the risk of electric shock.

## POWER TOOL USE AND CARE

- Do not force the power tool. Use the correct power tool for your application. The correct power tool will do the job better and safer at the rate for which it was designed.
- Do not use the power tool if the switch does not turn it on and off. Any power tool that cannot be controlled with the switch is dangerous and must be

# SAFETY INFORMATION

Please read these instructions fully before operating or maintaining your machine

repaired.

- Disconnect the plug from the power source and/ or the battery pack from the power tool before making any adjustments, changing accessories, or storing power tools. Such preventive safety measures reduce the risk of starting the power tool accidentally.
- Store idle power tools out of the reach of children and do not allow persons unfamiliar with the power tool or these instructions to operate the power tool. Power tools are dangerous in the hands of untrained users.
- Maintain power tools. Check for misalignment or binding of moving parts, breakage of parts and any other condition that may affect the power tool's operation. If damaged, have the power tool repaired before use. Many accidents are caused by poorly maintained power tools.
- Keep cutting tools sharp

and clean. Properly maintained cutting tools with sharp cutting edges are less likely to bind and are easier to control.

- Use the power tool, accessories and tool bits etc. in accordance with these instructions, taking into account the working conditions and the work to be performed. Use of the power tool for operations different from those intended could result in a hazardous situation.

## PERSONAL SAFETY

- Stay alert, watch what you are doing and use common sense when operating a power tool. Do not use a power tool while you are tired or under the influence of drugs, alcohol or medication. A moment of inattention while operating power tools may result in

# SAFETY INFORMATION

Please read these instructions fully before operating or maintaining your machine

serious personal injury.

- Use personal protective equipment. Always wear eye protection. Protective equipment such as dust mask, non-skid safety shoes, hard hat, or hearing protection used for appropriate conditions will reduce personal injuries.
- Prevent unintentional starting. Ensure the switch is in the off-position before connecting to power source and/or battery pack, picking up or carrying the tool. Carrying power tools with your finger on the switch or energising power tools that have the switch on invites accidents.
- Remove any adjusting key or wrench before turning the power tool on. A wrench or a key left attached to a rotating part of the power tool may result in personal injury.
- Do not overreach. Keep proper footing and balance at all times. This enables

better control of the power tool in unexpected situations.

- Dress properly. Do not wear loose clothing or jewellery. Keep your hair, clothing and gloves away from moving parts. Loose clothes, jewellery or long hair can be caught in moving parts.
- If devices are provided for the connection of dust extraction and collection facilities, ensure these are connected and properly used. Use of dust collection can reduce dust-related hazards.

## OPERATIONAL SAFETY

- Use the product only in daylight or good artificial light.
- Never operate the machine with damaged guards or shields or without guards or shields in place.
- Take care against injury to



# SAFETY INFORMATION

Please read these instructions fully before operating or maintaining your machine

feet and hands from the cutting means.

- Before use check the controls and proper use of the product.
- Before using the product and after any impact, check for signs of wear or damage and repair as necessary.
- Always disconnect the product from the power supply (i.e. remove the plug from the power supply or the battery pack)
  - whenever leaving the product unattended;
  - before clearing a blockage;
  - before checking, cleaning or working on the product
  - after striking a foreign object;
  - whenever the product starts vibrating abnormally.
- Take care against injury to feet and hands from the cutting attachment.
- Switch on the motor only when the hands and feet are away from the cutting means.

- Always ensure that the air vents are kept clear of debris.
- After extending new cutter line always return the product to its normal operating position before switching on.
- Never fit metal cutting elements.
- Never replace non-metallic cutting means with metallic cutting means.
- Never use replacement parts or accessories not provided or recommended by the manufacturer.
- The product should be supplied via a residual current device (RCD) with a tripping current of not more than 30 mA.
- Avoid using the product in bad weather conditions especially when there is a risk of lightning.
- Position the cord so that it will not be caught by the cutting attachment during operation.

# SAFETY INFORMATION

Please read these instructions fully before operating or maintaining your machine

- Disconnect from the power supply when the cord becomes damaged or tangled.

- If the cord becomes damaged during use, disconnect the cord from the supply immediately.  
**DO NOT TOUCH THE CORD BEFORE DISCONNECTING THE SUPPLY.**

- Do not use the product if the cord is damaged or worn.

- Warning! The cutting elements continue to rotate after the product is switched off.

- Keep the cord away from cutting elements.

- Only use an extension cord not lighter than:

- if rubber insulated, ordinary tough rubber sheathed flexible cord (code designation 60245 IEC 53);

- if polyvinyl chloride insulated, ordinary polyvinyl chloride sheathed flexible

cord (code designation 60227 IEC 53).

- Do not expose the product to rain.

## MAINTENANCE AND STORAGE SAFETY

- Disconnect the product from the power supply (i.e. remove the plug from the power supply or the battery pack) and check for damage after use.

- Disconnect the product from the power supply (i.e. remove the plug from the power supply or the battery pack) before carrying out maintenance or cleaning work.

- Use only the manufacturer's recommended replacement parts and accessories.

- Inspect and maintain the product regularly. Have the product repaired only by an authorised service centre or

# SAFETY INFORMATION

Please read these instructions fully before operating or maintaining your machine

similar qualified specialist.

- When not in use, store the product out of the reach of children.
- Have your power tools serviced by a qualified repair person using only identical replacement parts. This will ensure that safety of the power tool is maintained.

manufacturer from his or her legal liability.

## INTENDED USE

This electric grass trimmer is designed for domestic use only:

to trim grass, lawn edges and light foliage.

This machine is not designed for heavy duty or commercial use.

Any use of the machine that deviates from its intended use and is not included in these instructions is considered unauthorized use and relieves the

# BOX CONTENT

## PARTS

- |   |                                  |    |                         |
|---|----------------------------------|----|-------------------------|
| 1 | 10m cable                        | 9  | Tilt adjustment pedal   |
| 2 | Main handle                      | 10 | Pole                    |
| 3 | On/off Switch                    | 11 | Knob                    |
| 4 | Cable retainer                   | 12 | Angle adjustment button |
| 5 | Front handle                     | 13 | Cable collector         |
| 6 | Locking sleeve length adjustment | 14 | Support wheel           |
| 7 | Guard                            | 15 | Spare spool             |
| 8 | Plant protector                  |    |                         |

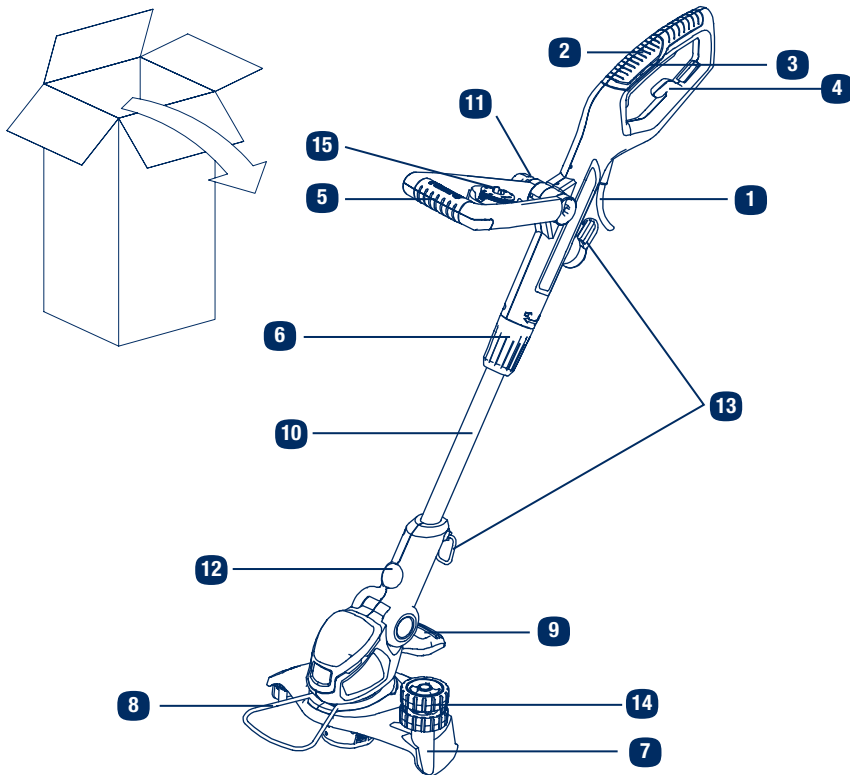

If there are any parts missing, please call the customer helpline on 0345 605 2067

# ASSEMBLE

## 1 Safety guard assembly

- i. Remove four mounting screws from motor housing.

Note: They are pre-mounted on the motor housing by factory to help end-user find them quickly. And send a message to end-user, where these four screws should be used for.

- ii. Fit the safety guard onto the motor housing.
- iii. Fix the safety guard in place by using these four screws.

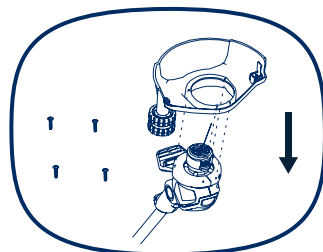

## 2 Front handle assemble

- i. Loosen the knob and remove it together with the bolt from the auxiliary handle.
- ii. Align the auxiliary handle to the support and place it onto it.

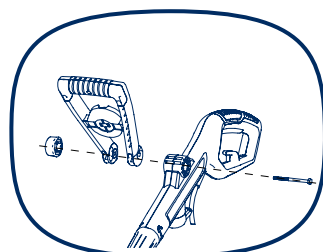

- iii. Insert the bolt from the right through the opening. Ensure that the bolt head sits properly in the recessed shape in the support then tighten the knob.

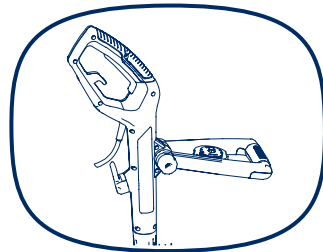

## 3 Plant protector assemble

- i. Assemble the plant protector into the slot in between the guard and the motor housing.

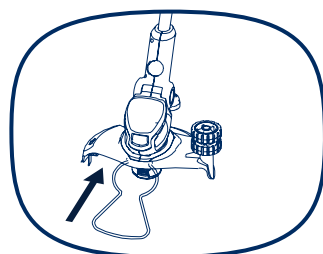

# ASSEMBLE

## 4 Cord strain relief

- i. Make sure the on/off switch is in its off position.
- ii. Double the cord, about 3cm from the end. Lead the loop through the hole on the rear safe guard and hook the loop over the cord strain relief. Gently pull on the cord to ensure that it is firmly attached.

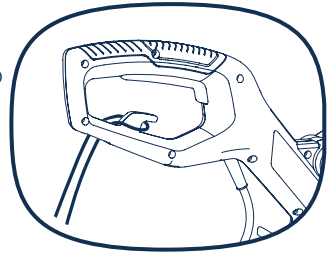

# OPERATION

## General operation

- i. Check the product, its power cord and plug as well as accessories for damage before each use. Do not use the product if it is damaged or shows wear.
- ii. Double check that accessories or cutting device are properly fixed.
- iii. Always hold the product on its handles. Keep the handles dry to ensure safe support.

## Height adjustment

- i. Loosen the locking sleeve counter clockwise.
- ii. Adjust the pole length to fit your body height.
- iii. Tighten the locking sleeve anti-clockwise.

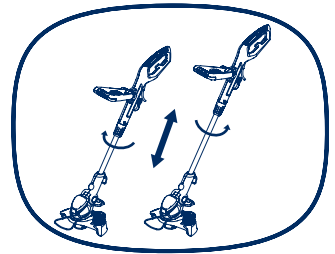

## Handle adjustment

Adjust the angle of the auxiliary handle to ease operation and prevent loss of control.

- i. Loosen the knob and move the handle up or downward.
- ii. Tighten the knob to secure the auxiliary handle in the adjusted position.

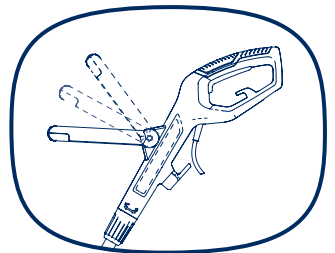

# OPERATION

## Tilt adjustment

Adjust the vertical angle of the trimmer head to fit the trimming conditions.

- i. Press the tilt adjustment pedal down with your foot.
- ii. Adjust the angle of the pole, up or down.
- iii. Release the unlock pedal and keep moving the pole until it locks in place.

**NOTE:** Always ensure that the pedal snaps into place after adjusting the trimmer in one of the five positions!

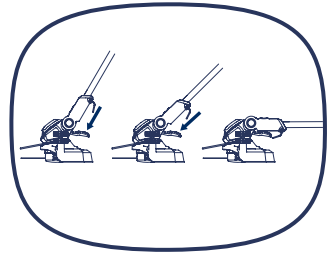

## Edging

- i. Adjust the vertical angle of trimmer head to 0 degree by pressing the tilt adjustment pedal.
- ii. Adjust the trimmer head to 90 degrees for edging by pressing the locking button.
- iii. Twist the plant protector to an angle of 90°.

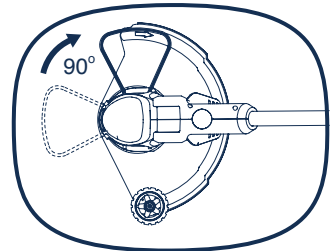
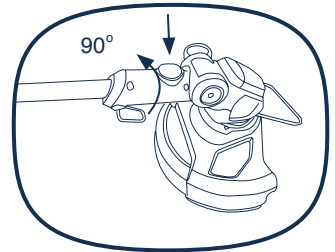

## Automatic line feeding

The equipment features a fully automatic dual line system.

The lines will automatically elongate every time you turn on the



# OPERATION

appliance. To support proper line elongation, ensure that the coil has stopped moving completely before turning on the appliance again.

The lines are automatically cut to the correct length by the line cutter.

## Plant protector

Use the plant protector to keep distance to plants like flowers, trees or other objects that could be hit by the cutting device.

- i. Fold the plant protector out for trimming / edging operation.
- ii. Fold the plant protector in for storage.

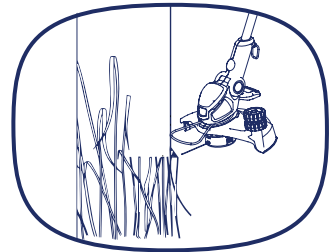

**WARNING!** Adjust the plant protector position only when the product is switched off and the cutting device is at a complete stop!

## Switching on/off

- i. Connect the plug to the mains socket- this product runs on 240V.
- ii. Press the on/off switch (3) to turn the product on.
- iii. Release the on/off switch (3) to turn the product off.

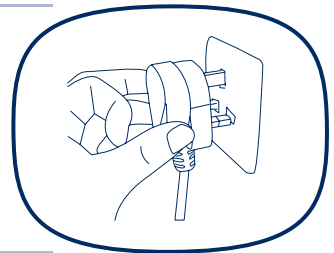

## Trimming

- i. Ensure the knife protector label is removed before use. Ensure you wear gloves when removing this label.
- ii. Adjust the trimmer head angle to a proper position for trimming operation.
- iii. Hold the grass trimmer firmly, keeping your balance with feet slightly apart. Alter the height of the product if needed to ensure an upright posture.

# OPERATION

iv. Hold the trimmer head just above the ground at an angle of approximately 30°.

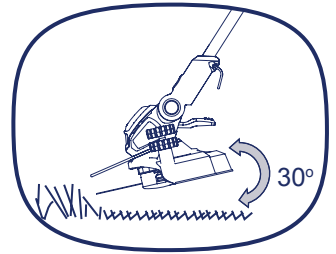

v. Move the product slowly from side to side in a swinging motion.

vi. Ensure the cutting device remains clean and free from off-cuts that may cause it to jam. Check regularly. Release the on/off switch and disconnect the product from the power supply before checking.

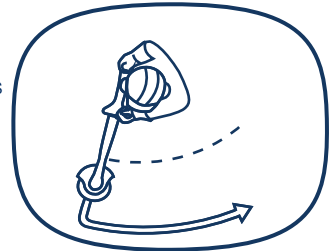

vii. Trim longer grass in stages; do not cut long grass in one cut. For the best results, cut longer grass in steps.

viii. Place the trimmer along the edge of the lawn.

ix. Turn product on and push the trimmer forward slowly.

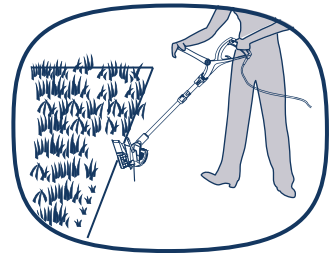

# OPERATION

## WARNING!

- Always fit the guard before using the product
- When cutting longer /high grass, please make sure that you cut this down in 2 to 3 stages.
- DO NOT cut long grass in one cut, as this will damage your grass trimmer, and make your warranty invalid.

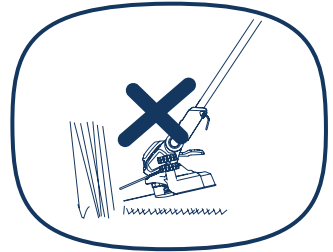
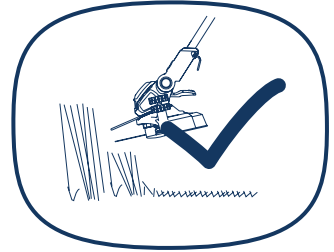

## Tips

- i. For best results, do not cut wet grass because it tends to stick to the cutting head and guard, prevents proper discharge of grass trimmings, and could cause you to slip and fall.
- ii. Do not allow the spool cover to drag on the ground or other surfaces.
- iii. Pay special attention when performing the work close to trees and bushes. The cutting head could damage sensitive bark, and damage fence posts.
- iv. Fold the plant protector out to avoid bringing the cutting device into contact with hard objects such as walls and kerbstones.

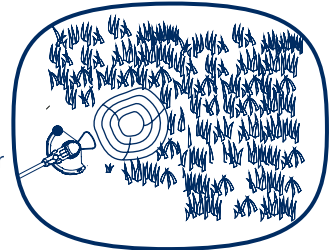

**NOTE:** The trimming line will wear faster and require more feeding if the cutting or edging is done along sidewalks or other abrasive surfaces or heavier weeds are being cut.

# MAINTENANCE

**This product does not contain any parts that can be repaired by the consumer. Contact an authorised service centre or a similarly qualified person to have it checked and repaired.**

## Replacing the spool

**NOTE:** Before replace the spool, make sure the mains plug is disconnected from the unit.

- i. Press together both locking device tabs on the spool cover and remove the cover.
- ii. Remove the old spool from the spool cover
- iii. Clean out any dirt or grass residue.

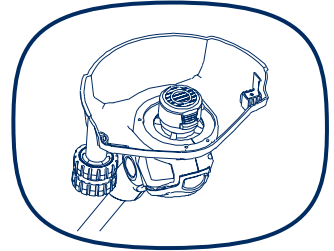

- iv. Put the new spool in the spool housing, thread the line into the hole.

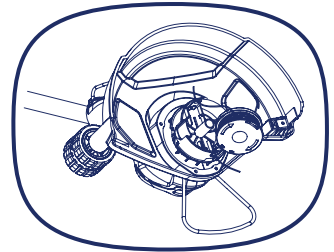

---

## Winding the line

**NOTE:** Should you wish to wind the line yourself, the instructions are provided below:

Self-winding, however, is NOT recommended because if the line is not wound properly it can cause the trimmer's feed system to malfunction. For this reason, users are strongly urged to purchase the pre-wound spool.

# MAINTENANCE

---

- i. Hold the loose ends of the line together with one hand, find the center of the line with the other hand and hook this center loop into the groove on the spool.

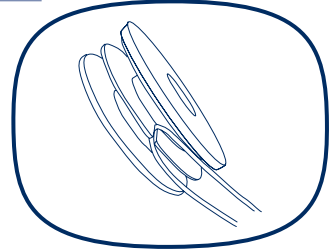

- ii. Wind the line following the directional arrows on the spool housing and hook the two ends into the side grooves.

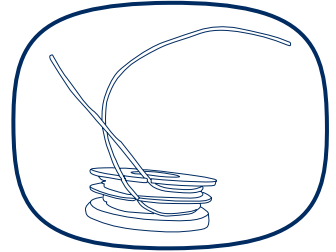

---

## Storage

- i. Store the product and its accessories in a dry, frost-free place.
  - ii. Always store the product in a place that is inaccessible to children. The ideal storage temperature is between 10°C and 30°C.
- 
- 

## Transportation

- i. Switch the product off and disconnect from power supply before transporting it anywhere.
  - ii. Protect the product against scratching and secure it to avoid damage from impact.
-

# MAINTENANCE

---

## After use

- i. Switch the product off, disconnect it from the power supply and let it cool down.
  - ii. Fold the plant protector in.
  - iii. Check, clean and store the product as described below.
- 
- 

## Recycling and disposal

- i. Waste electrical products should not be disposed of with household waste. Please recycle where facilities exist. Check with your Local Authority or local store for recycling advice.
- ii. The product comes in a packaging that protects it against transportation damage. Keep hold of the packaging until you are sure that all the parts have been delivered and the product is functioning properly. Recycle the packaging afterwards.



# TECHNICAL DATA

Model	S3525ET
Input voltage rating	240V ~ / 50 Hz
Input power	350W
No load speed	12000/min
Trimming line	Ø 1.2 mm, length 8m
Cutting width	25cm
Angle adjustment	0°~90°
Weight	3kg
Vibrations	3.97m/s <sup>2</sup> , K=1.5m/s <sup>2</sup>

Part number	Accessories
GT350-61	Front handle
GT350-60	Knob
GT350-49	Trimmer spool
GT350-19	Plant protector

# TECHNICAL DATA

---

Measured sound pressure level  $L_pA$ : 82.4dB(A),  $K=3dB(A)$

Measured sound power level  $L_wA$ : 96dB(A),  $K=3dB(A)$

Guaranteed sound power level  $L_wA$ : 96dB(A)

The sound values have been determined according to noise test code given in EN 50636-2-91, using the basic standards EN ISO 11201 and EN ISO 3744.

The sound intensity level for the operator may exceed 80dB(A) and ear protection measures are necessary.

The declared vibration value has been measured in accordance with a standard test method (according to EN 50636-2-91) and may be used for comparing one product with another. The declared vibration value may also be used in a preliminary assessment of exposure.

**WARNING!** Depending on the actual use of the product the vibration values can differ from the declared total! Adopt proper measures to protect yourself against vibration exposures! Take the whole work process including times the product is running under no load or switched off into consideration!

Proper measures include among others regular maintenance and care of the product and cutting attachments, keeping hands warm, periodical breaks and proper planning of work processes!



# TROUBLESHOOTING

Suspected malfunctions are often due to causes that the user can fix themselves.

Therefore, check the product using this section. In most cases the problem can be solved quickly.



**WARNING!** Only perform the steps described within these instructions! All further inspection, maintenance and repair work must be performed by an authorised service centre or a similarly qualified specialist if you cannot solve the problem yourself! Gloves and appropriate protective clothing must be worn when performing these instructions.

Fault	Possible Cause	Solution
1. Product does not start	<ul style="list-style-type: none"><li>• Not connected to power supply</li><li>• Power cord or plug is defective</li><li>• Other electrical defect to the product</li></ul>	<ul style="list-style-type: none"><li>• Connect to a proper power supply.</li><li>• Call after sales support at 0345 605 2067</li><li>• Call after sales support at 0345 605 2067</li></ul>
2. Product does not reach full power	<ul style="list-style-type: none"><li>• Extension cord is not suitable for this product</li><li>• Power source (e.g. generator) has too low a voltage</li><li>• Air vents are blocked</li></ul>	<ul style="list-style-type: none"><li>• Use a proper extension cord</li><li>• Connect to another proper power supply</li><li>• Clean the air vents</li></ul>
3. Unsatisfactory result	<ul style="list-style-type: none"><li>• Line spool does not have sufficient line</li><li>• Line has not been conducted out of the spool or only one side</li></ul>	<ul style="list-style-type: none"><li>• Lengthen cutting line or exchange a new spool</li><li>• Remove spool and place line through opening outwards</li></ul>

# WARRANTY

If your device develops a fault, please don't hesitate to contact our customer service department on 0345 605 2067, we can solve 80% of problems via the phone.

1. These warranty terms cover additional warranty rights and do not affect your statutory warranty rights. All our products are covered by a 3 year manufacturer warranty.
2. Claims must be accompanied by Proof of Purchase. This must be in the form of a Sales receipt or Bank statement and must show that the product has been purchased within the warranty period as described under point 1, from the retailer that it was originally bought from. Please keep your receipt safe or staple it to the back of this manual for future reference.
3. Our warranty covers problems caused by material or manufacturing defects, and will result in the repair of these defects or replacement of the device with a like for like or similar article.
4. Our devices have not been designed for commercial, trade or industrial applications, any signs of use of the equipment in these application or equivalent activities, invalidates the warranty.
5. The following are also excluded from our warranty:
  - A. Faults due to accidents, customer misuse or unauthorized repairs
  - B. Consumable Parts such as cutting line, plant protector, handles, knobs, cable and other accessories that are compatible with the product.
  - C. Failure due to lack of routine maintenance.
  - D. Failure as a result of not using the equipment in accordance with the manual and safety instructions
  - E. The adjustment of cables, or spools

Warranty claims should be submitted before the end of the warranty period, see point 1, but a paid service exists for repairs commissioned after this period. The original warranty period remains applicable to the device even if repairs are carried out or parts are replaced. In such cases, the work performed or parts fitted will not result in an extension of the warranty period, and no new warranty will become active for the work performed or parts fitted.

If you have any problems or questions concerning your garden power tool, please contact our after sales service at 0345 605 2067.