

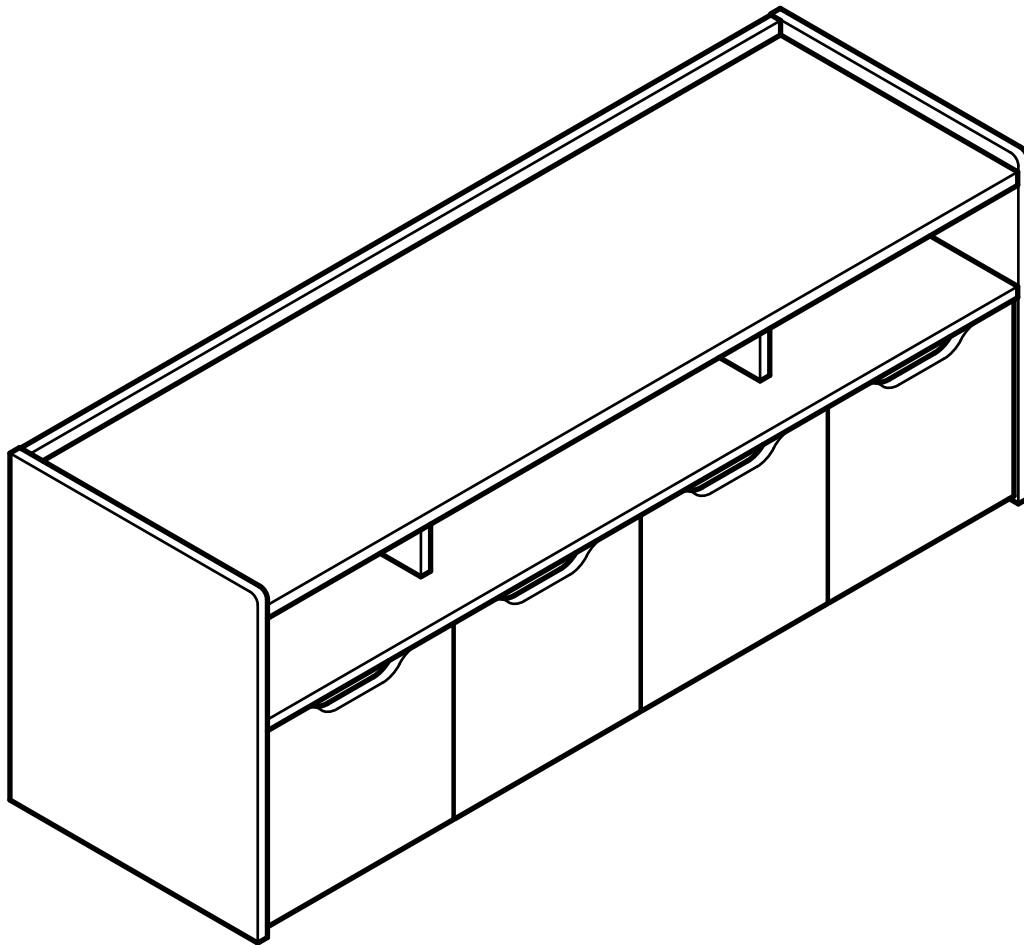

Compton

habitat



Spare Parts

 www.argos-support.co.uk

 Help@ClickSpares.co.uk

 0370 112 1928

Customer Support

 0345 640 2020



Safety and Care Advice

Product Details

Compton Shoe Bench With 4 Drawers 939/3103

IMPORTANT, RETAIN FOR FUTURE REFERENCE: READ CAREFULLY.

- Keep children and animals away from the work area, small parts could choke if swallowed.

- Make sure you have enough space to layout the parts before starting.

- This product has been constructed to be used in the domestic environment only and not for commercial purposes.

- Assemble the item as close to its final position (in the same room) as possible.

- Assemble on a soft level surface to avoid damaging the unit or your floor.

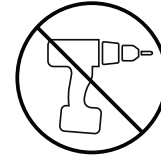

- We do not recommend the use of power drill/drivers for inserting screws as this could damage the unit. Only use hand screwdrivers.

- Parts of the assembly will be easier with 2 people.

- Dispose of all packaging carefully and responsibly.

Care and maintenance

- Only clean using a damp cloth and mild detergent. Do not use abrasive cleaners.

- Use a dry cloth to clean the product, furniture polish is not recommended.

- From time to time check that there are no loose screws, nuts or bolts. If there are please re-tighten.

- This product should not be discarded with household waste. Take to your local authority waste disposal centre.

WARNING

In order to prevent overturning this product must be used with the wall attachment device provided.

Additional Guidance

- Assemble all parts and bolts loosely during assembly, only once the product is complete should you fully tighten the bolts.

- Regularly check and ensure that all bolts and fittings are tighten properly.

- This product is compliant BS4875-7 level 3 & EN14749

Fittings (Shown to scale)

Bag 1

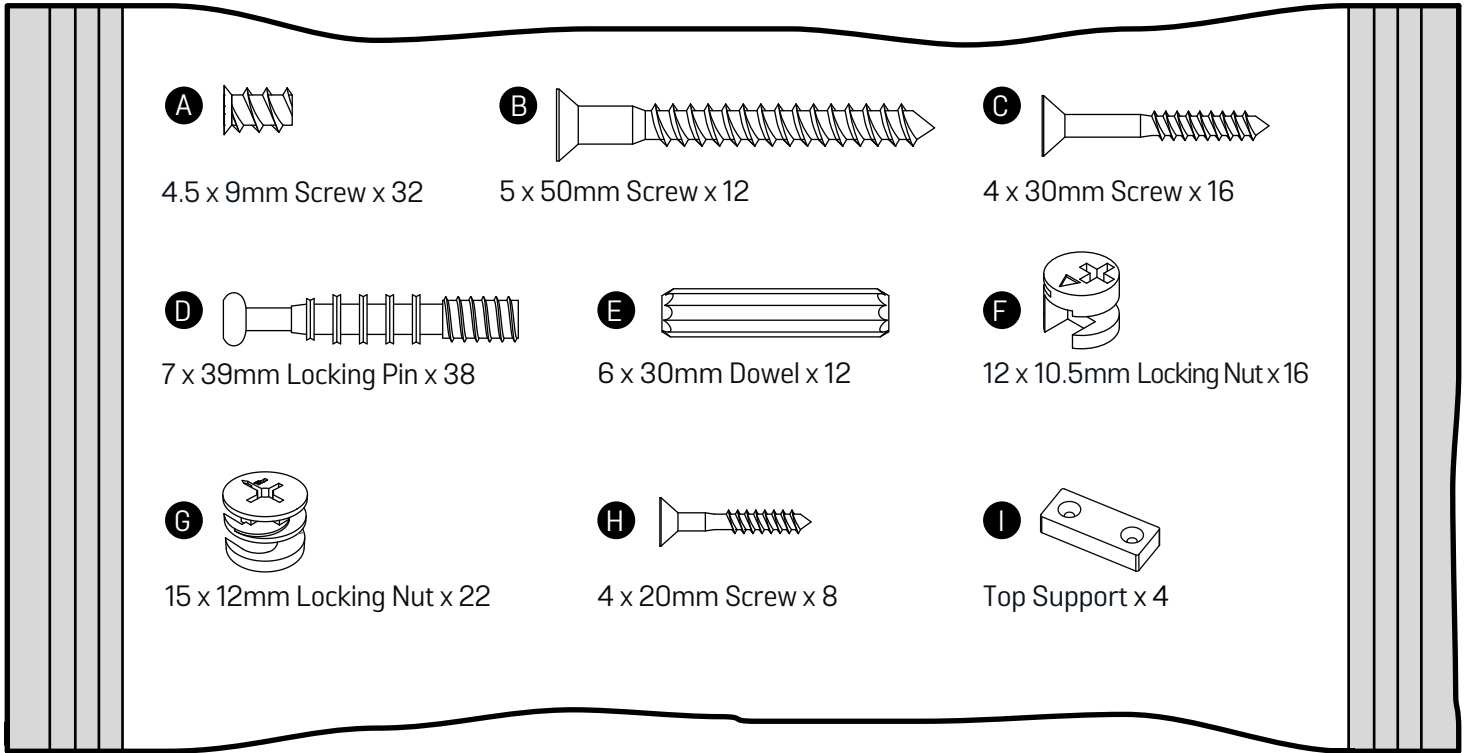

Hardware

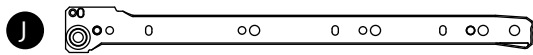

350mm Left Outside Runner x 4

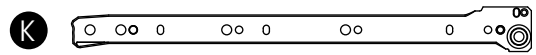

350mm Right Outside Runner x 4

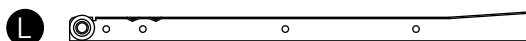

350mm Left Inside Runner x 4

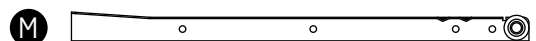

350mm Right Inside Runner x 4

Tools required

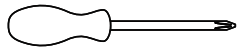

Phillips screwdriver
(small & medium)

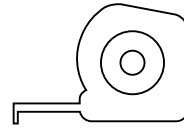

Ruler/tape
measure

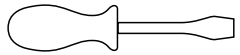

Phillips screwdriver
(small & medium)

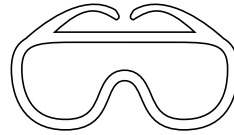

Eye protection
(when using a
hammer or glue)



Small
hammer

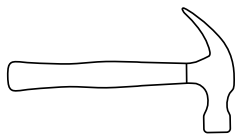

Large hammer

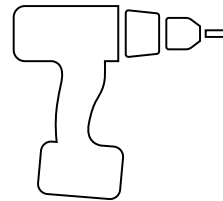

Power Drill

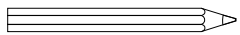

Pencil

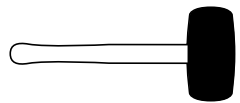

Mallet



Drill Heads



Set Square



Spirit Level

Panels



1 Top (1200 x 379mm)

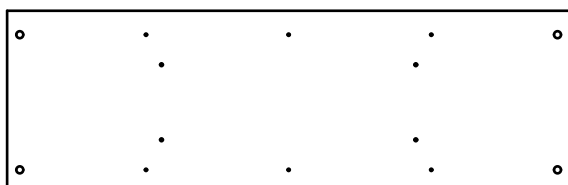

2 Shelf (1200 x 379mm)

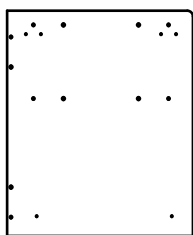

3 Right Side (396 x 480mm)

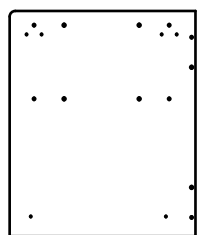

4 Left Side (396 x 480mm)

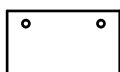

5 Upper Support (240 x 140mm) (x2)

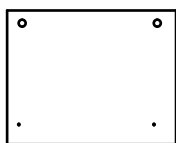

6 Bottom Support (360 x 285mm) (x3)

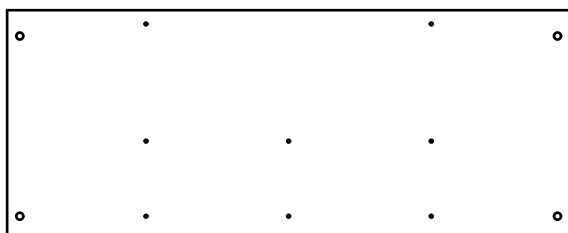

7 Back (1200 x 479mm)

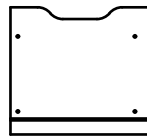

8 Right Front (270 x 295mm)

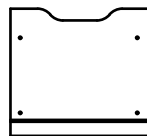

9 Middle Right Front (270 x 295mm)

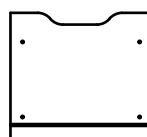

10 Middle Left Front (270 x 295mm)

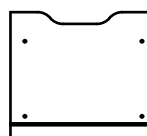

11 Left Front (270 x 295mm)



12 Drawer Back (237 x 224mm) (x4)

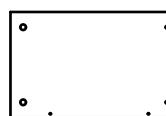

13 Drawer Right (340 x 224mm) (x4)

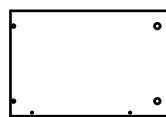

14 Drawer Left (340 x 224mm) (x4)

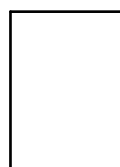

15 Drawer Bottom (246 x 336mm) (x4)

1

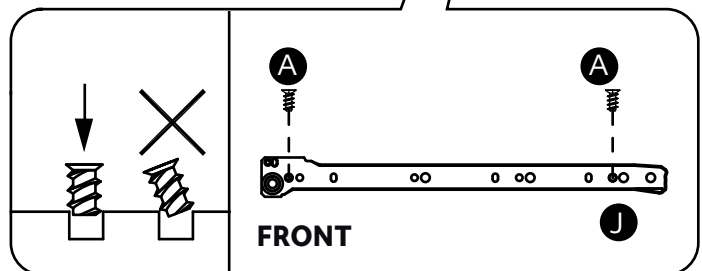
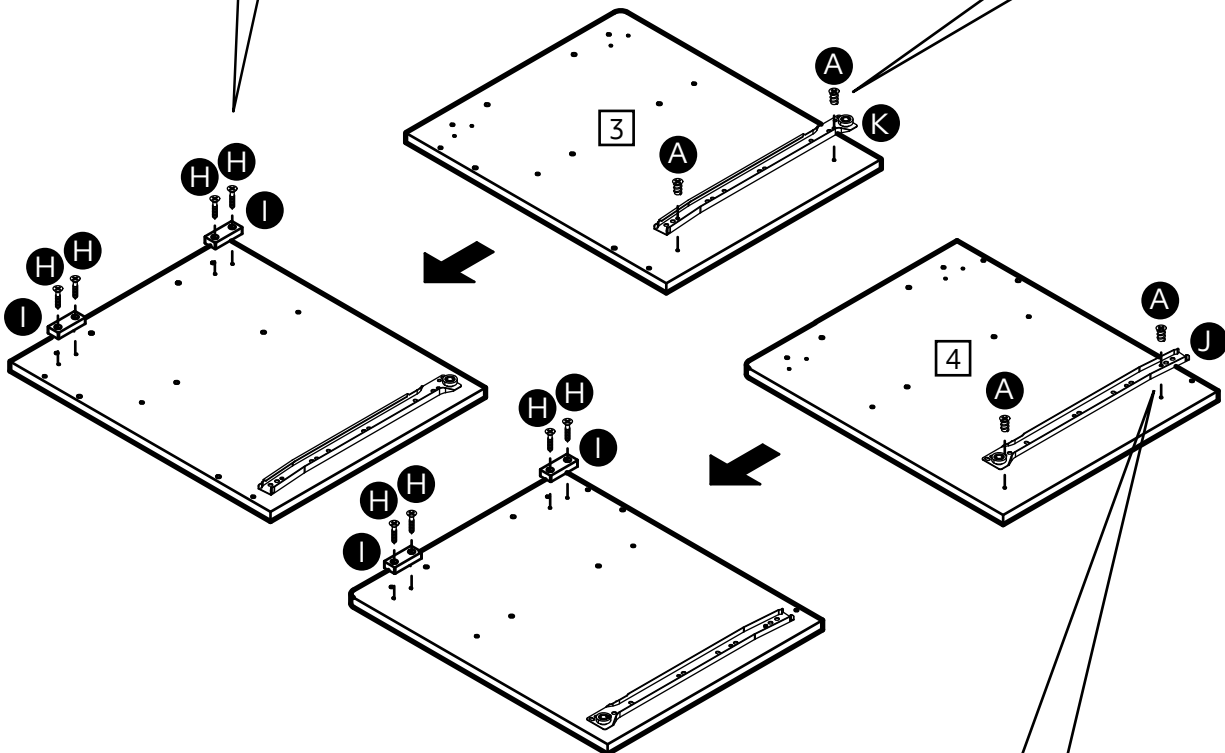
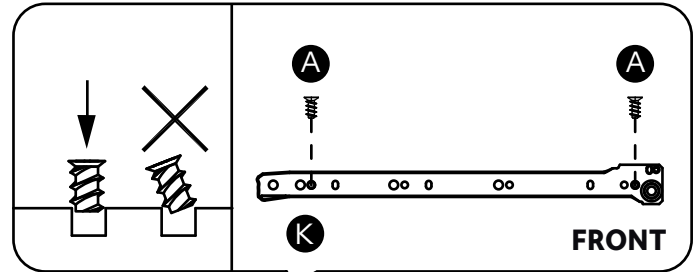
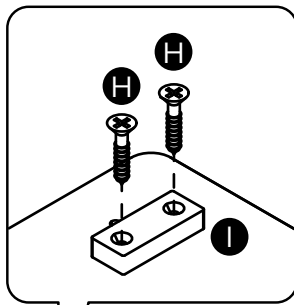
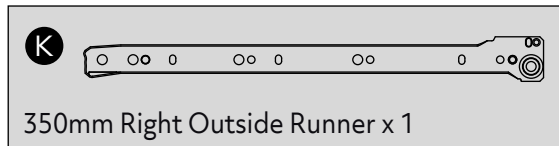
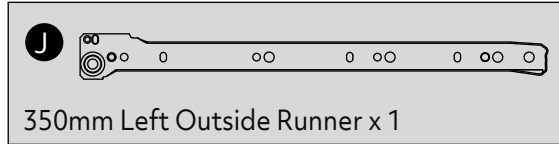
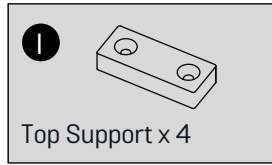
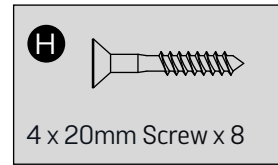
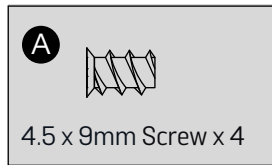
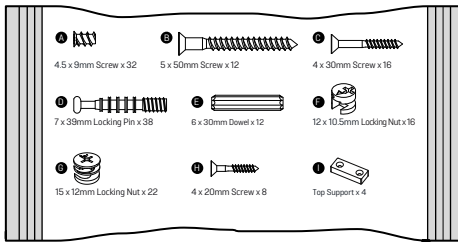

2

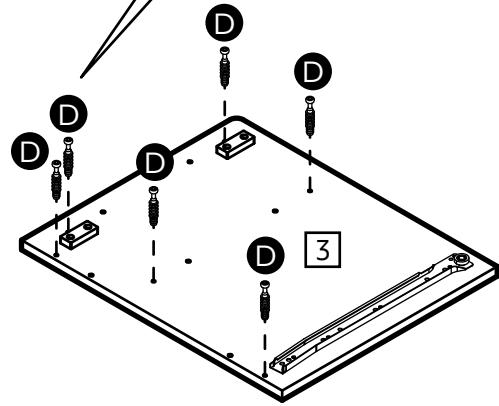
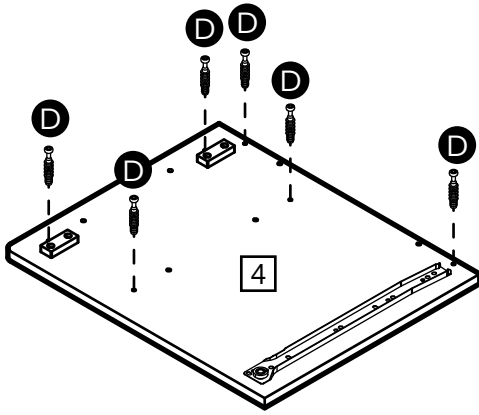
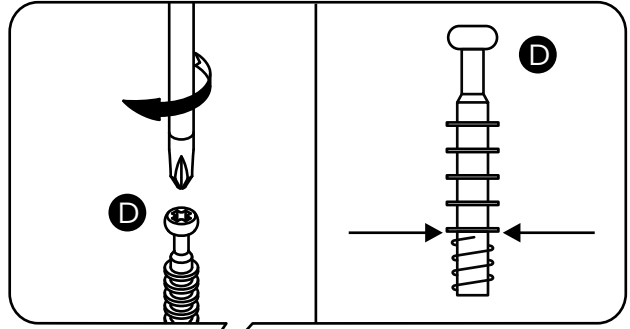
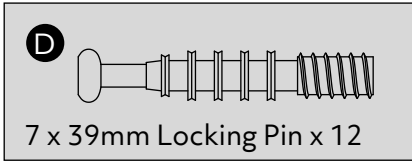

3

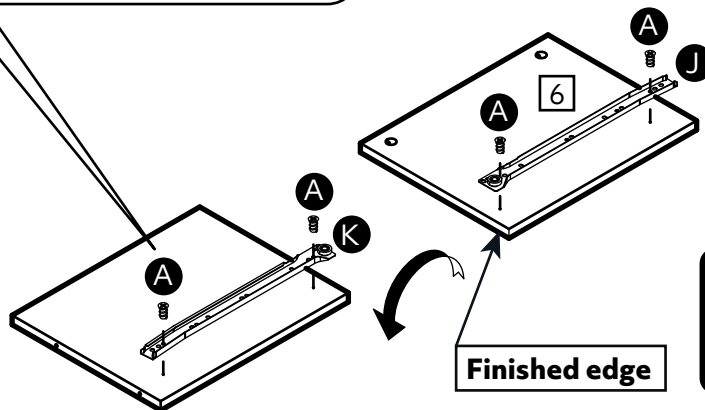
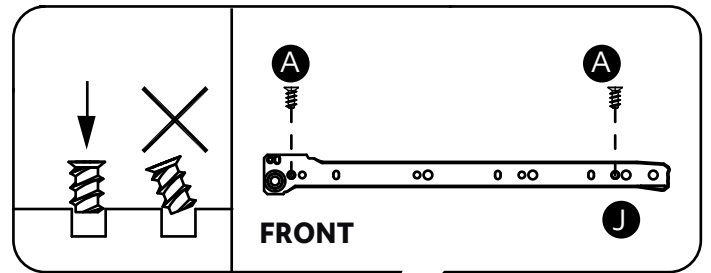
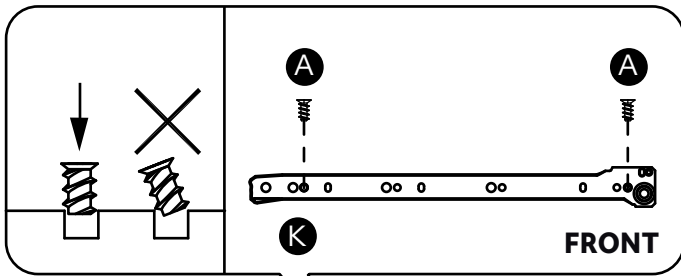
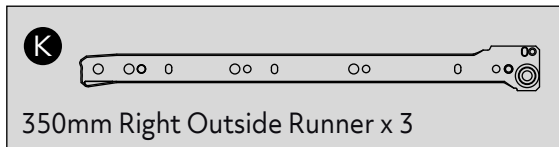
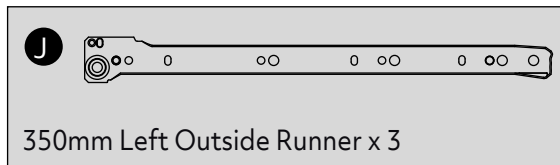

4

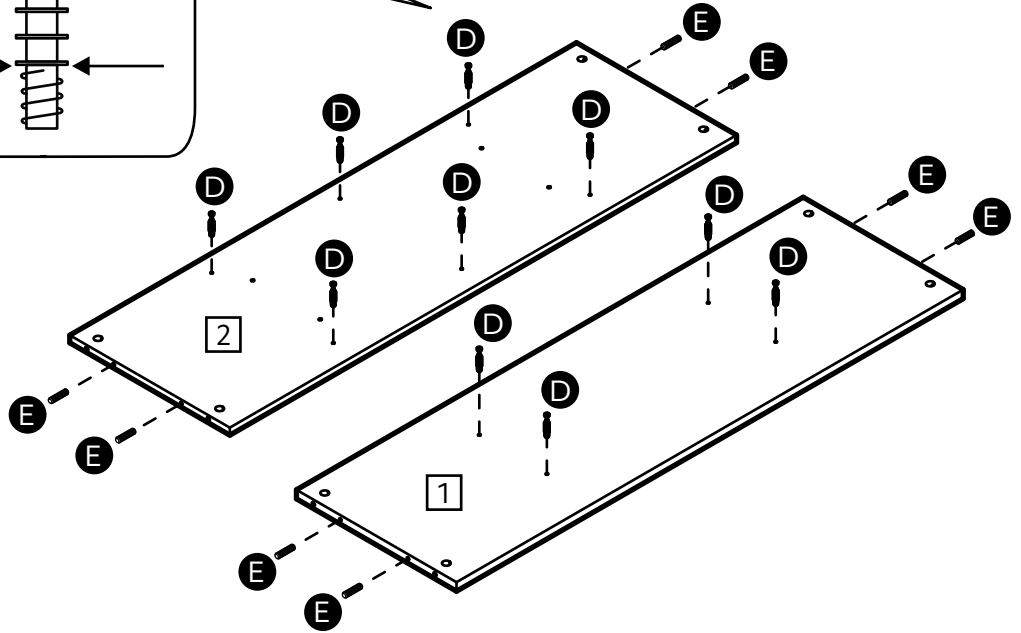
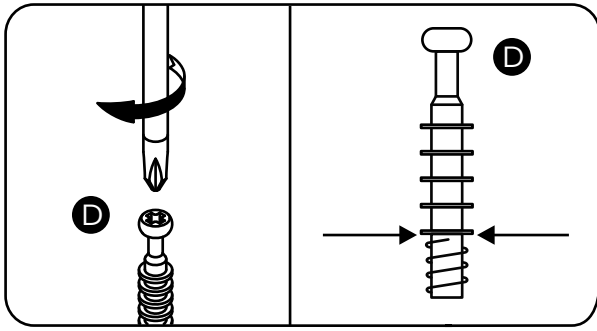
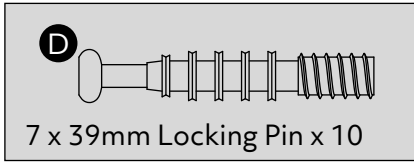

5

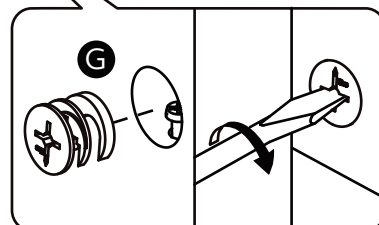
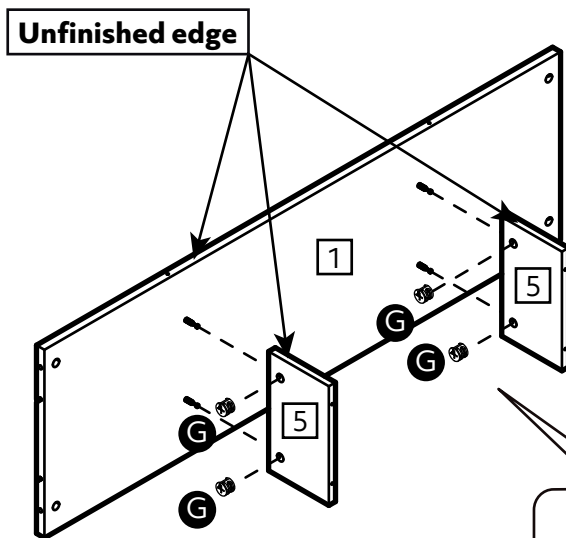
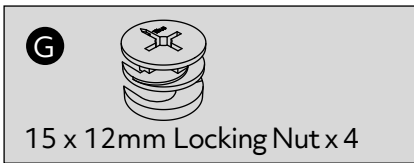

6

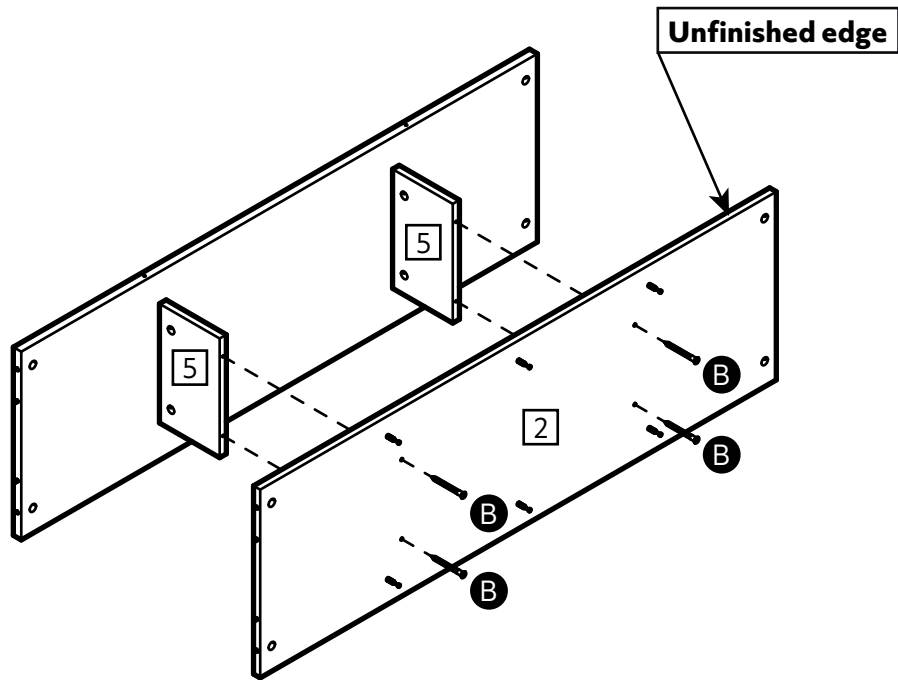
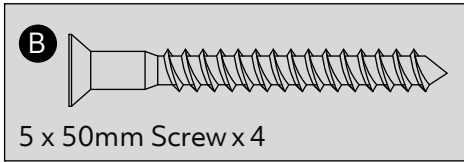

7

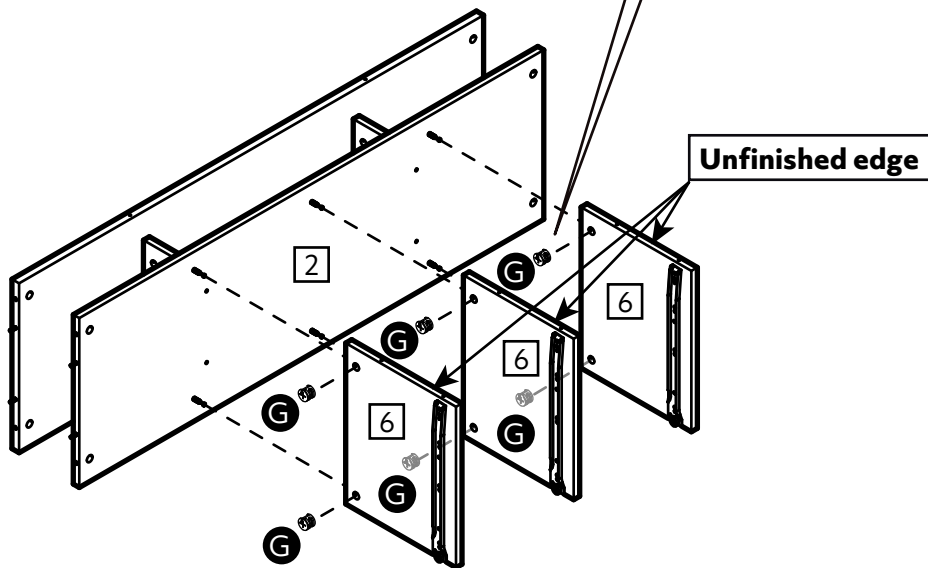
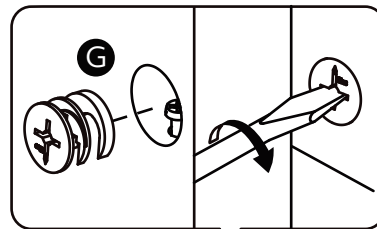
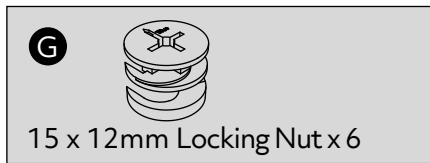

8

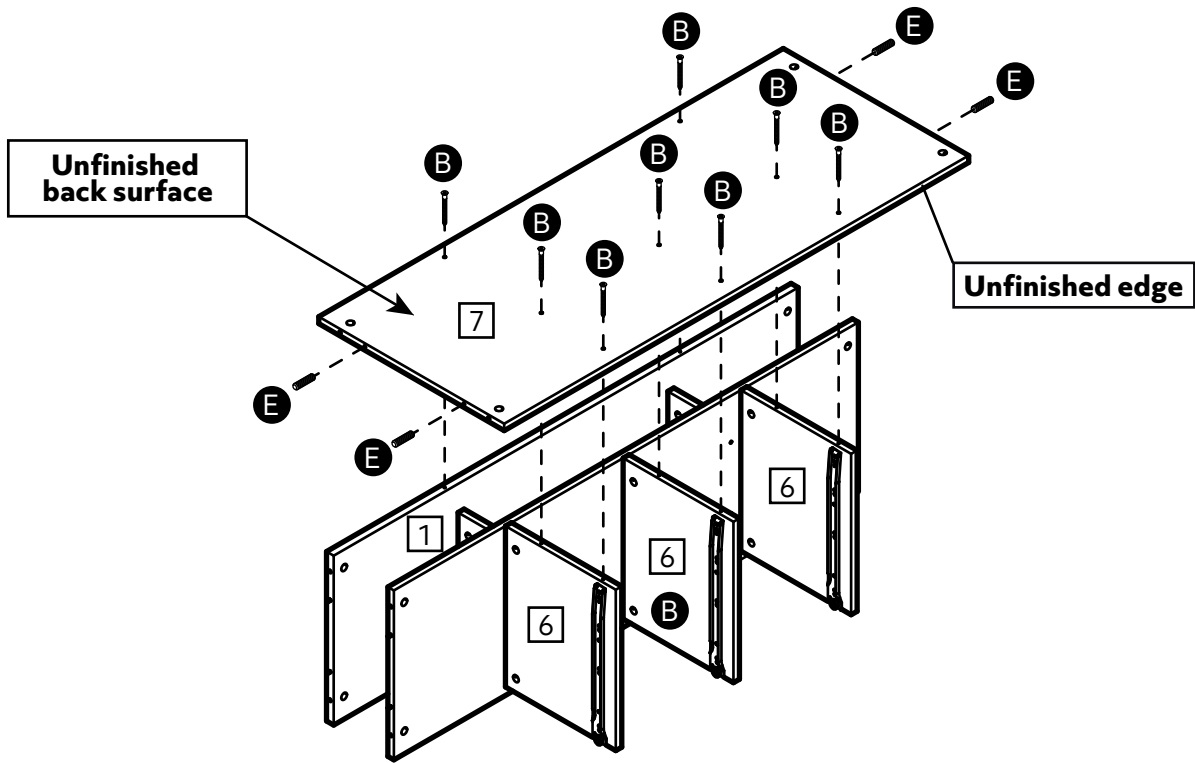
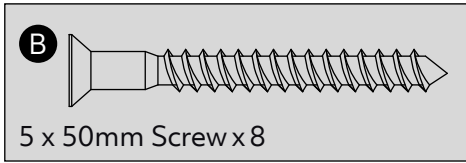

9

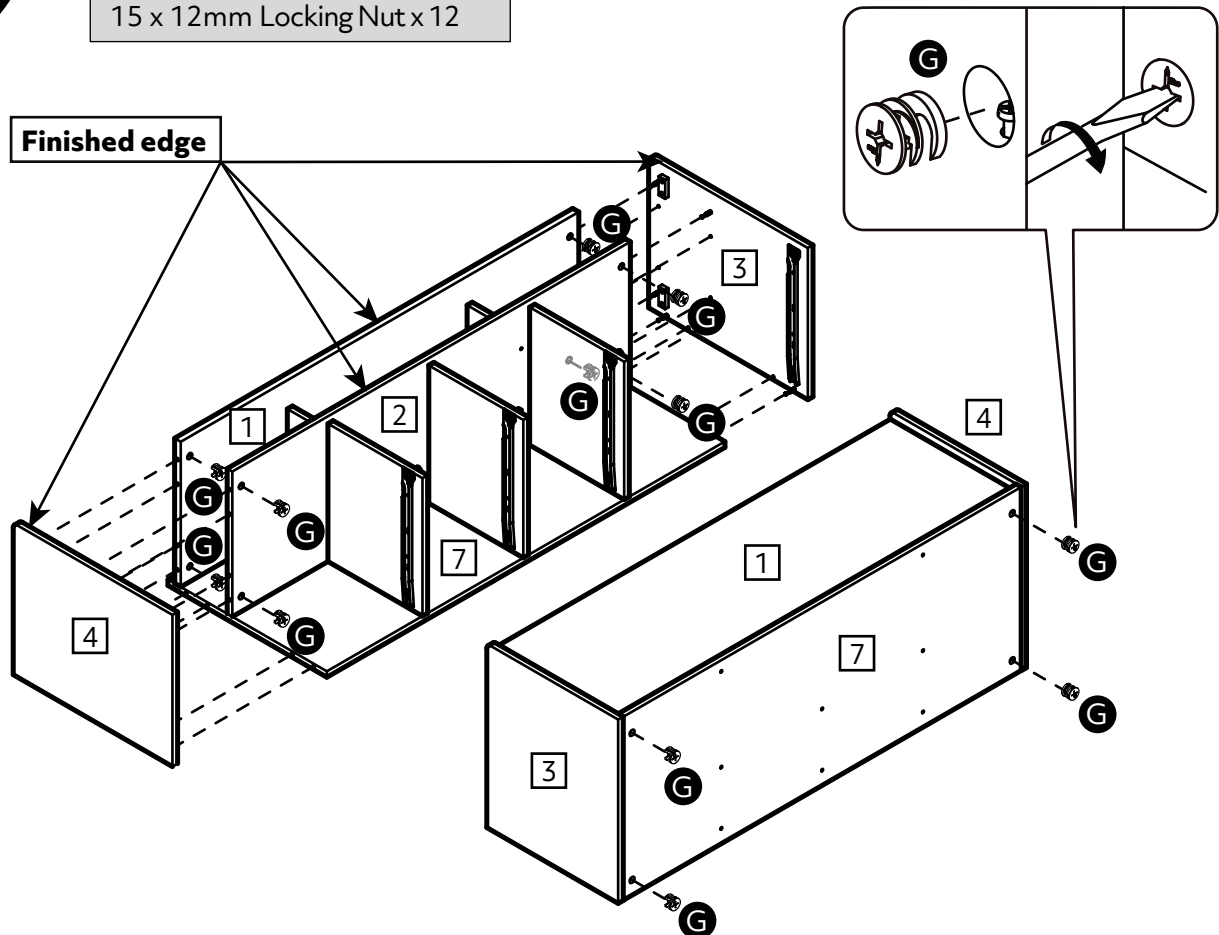
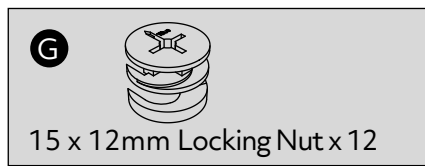

10

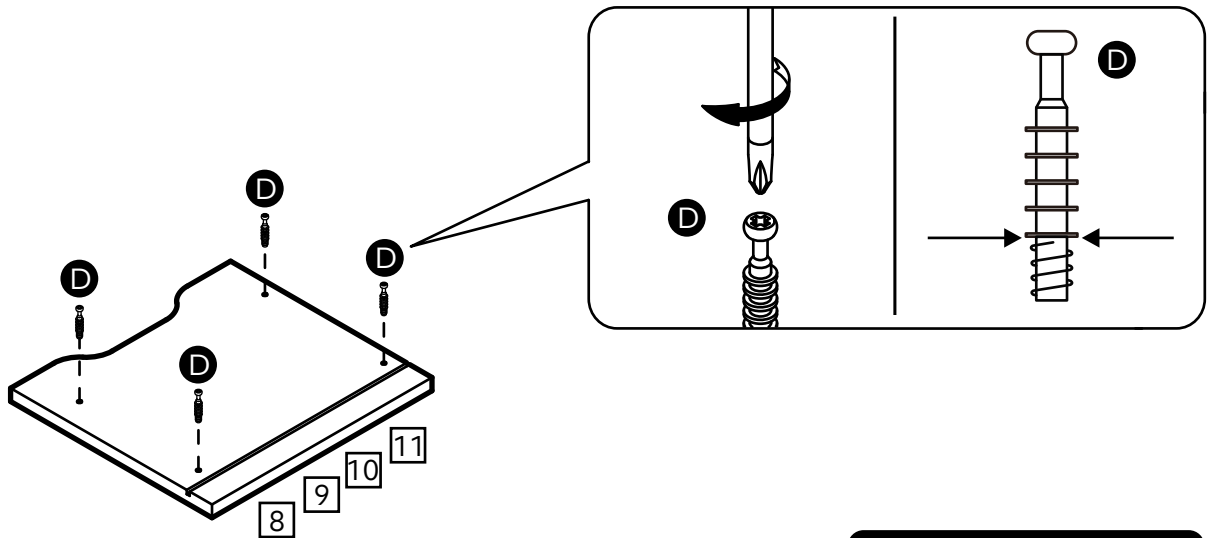
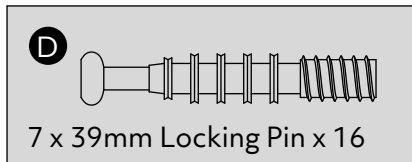

 Repeat
x4

11

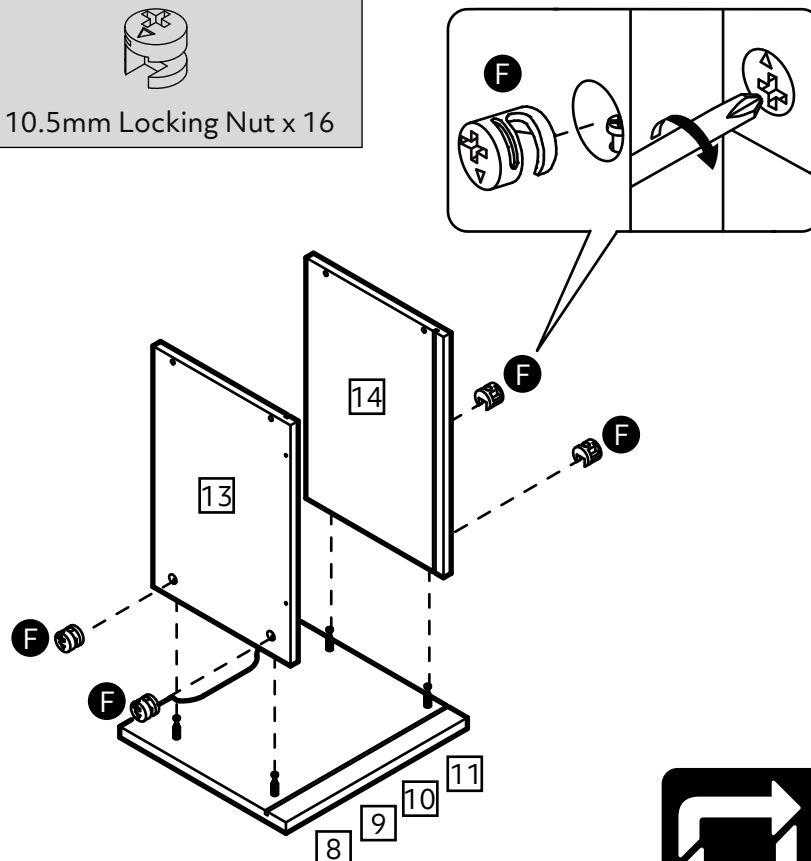
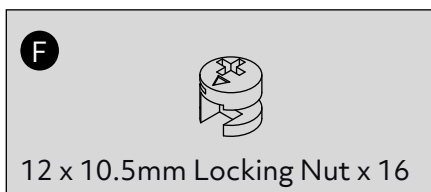

 Repeat
x4

12

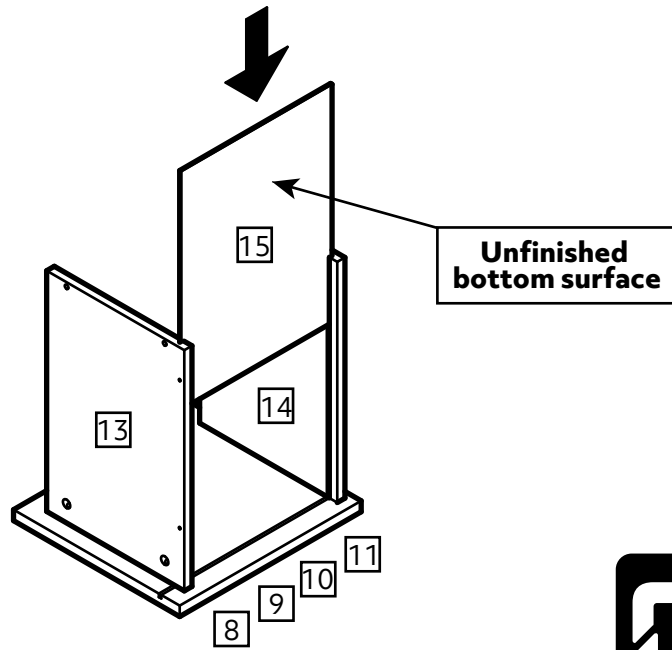

 Repeat
x4

13

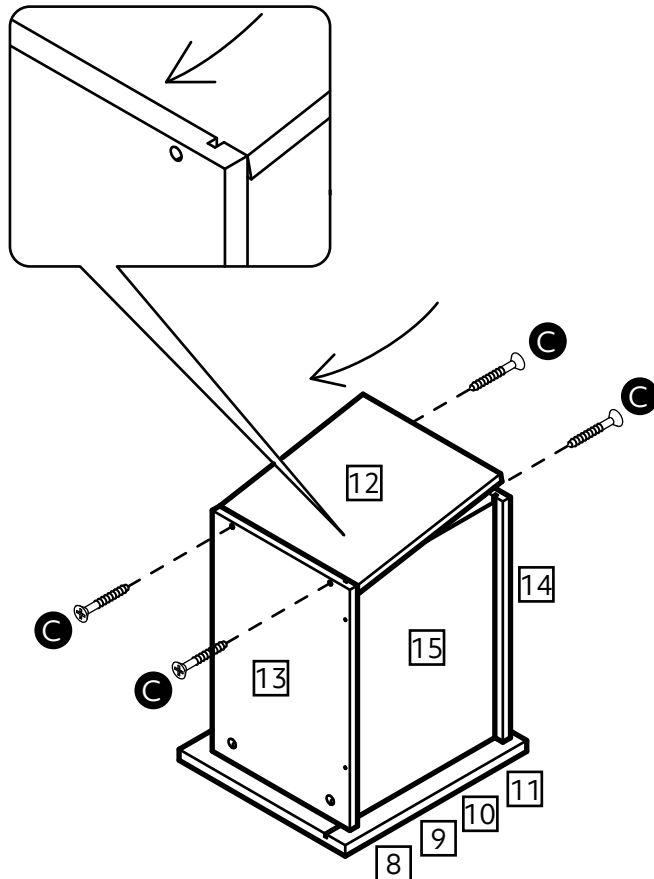
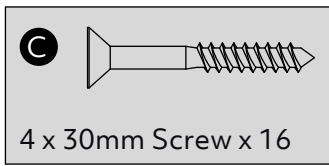

 Repeat
x4

14

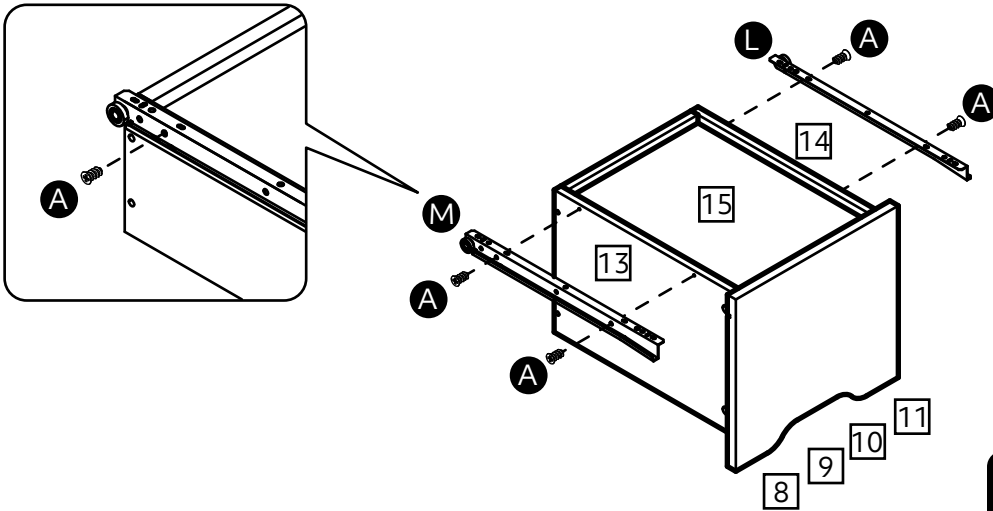
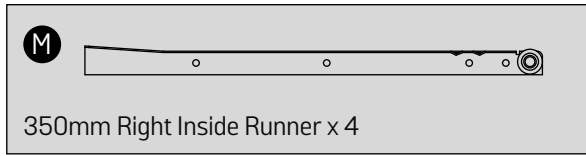
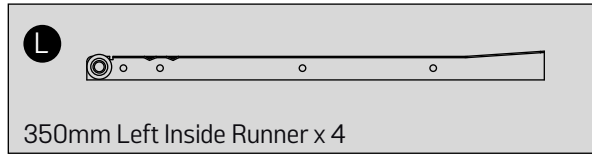
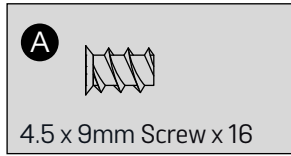

15

