

BRODI OCCASSIONAL TRAY TABLE

Assembly Instructions - Please keep for future reference

BROD-OT-SS17-A

Dimensions

Width - 46cm
Depth - 46cm
Height - 53.5cm

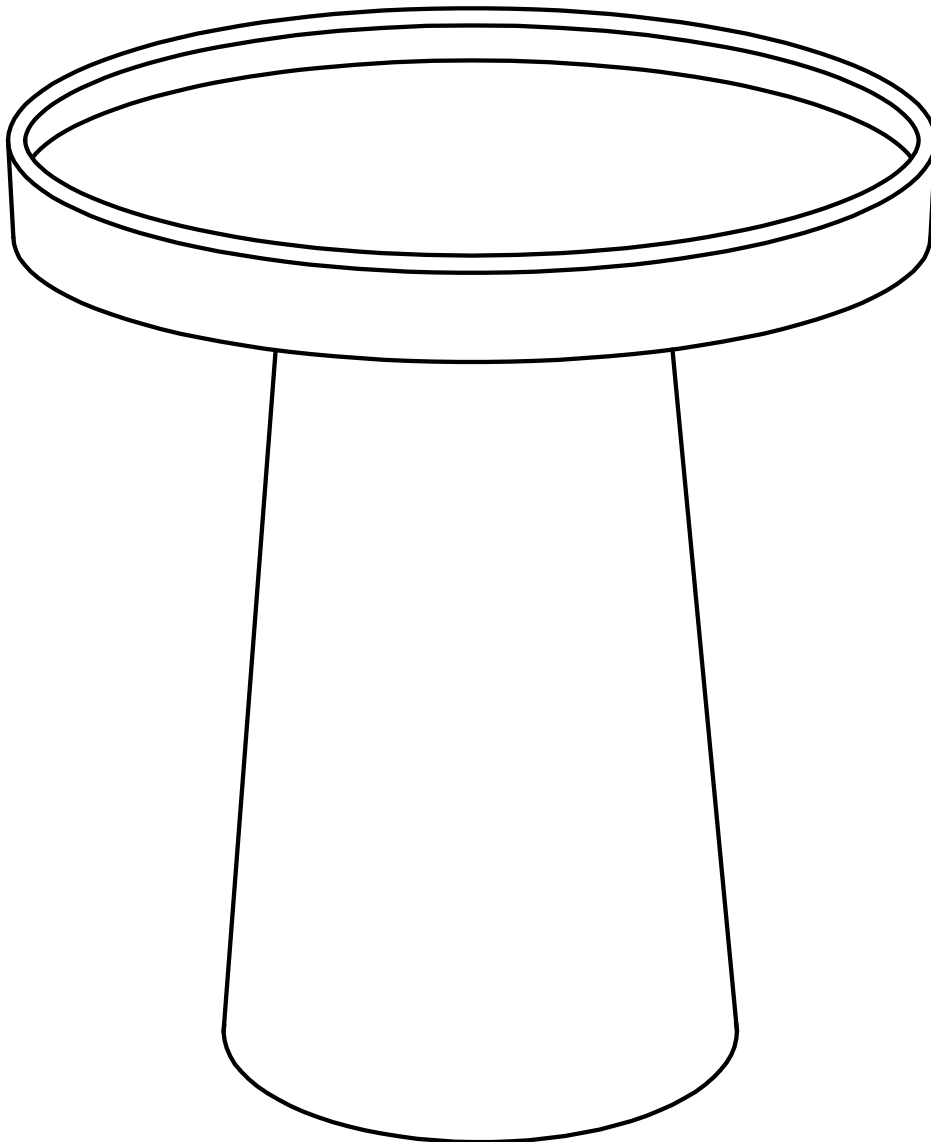

Important – Please read these instructions before assembly

If you need help or have damaged or missing parts, email:

customerservices@habitat.co.uk or call: 0344 499 4686

habitat 



Safety and Care Advice

Important – Please read these instructions fully before starting assembly

Do not stand on the product, this could cause damage.

Do not place your furniture directly in front of radiators, fires, or any source of direct heat.

Ensure that the surface on which you are assembling furniture is clean and flat.

Do not discard the packaging until the unit is fully assembled to ensure that no fitting or components are disposed of.

Dispose of all packaging carefully and responsibly.

General care and maintenance

Suitable for indoor use only!

Always use place mats and coasters to protect the surface from moisture and heat.

Avoid contact with abrasive materials and cleaning agents as they can damage the surface finish.

Dust regularly with a clean dry duster.

Wipe occasionally with a damp cloth.

Remove spills immediately with an absorbent cloth or paper towel to prevent staining.

Maximum weight limit

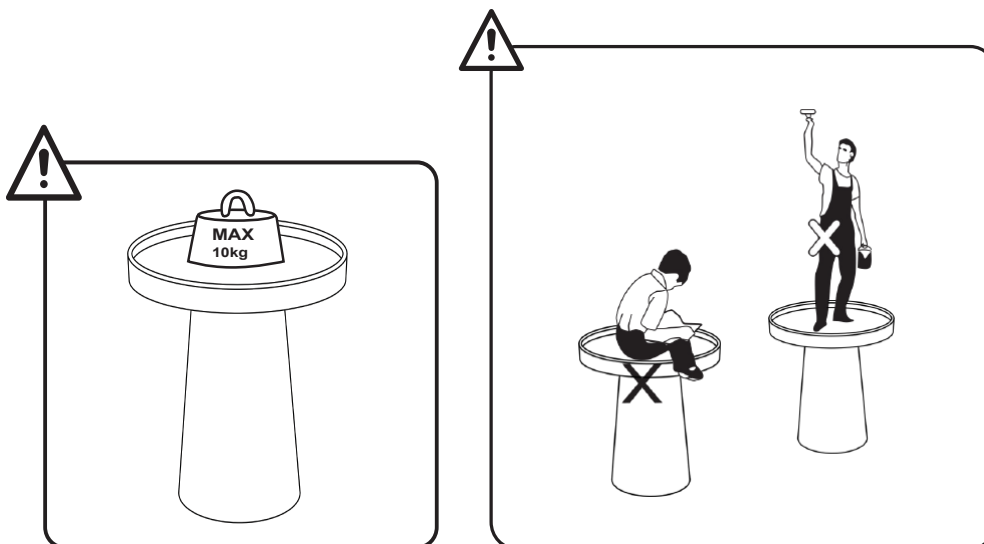

General information

If for any reason you should have problems with your Habitat product, please contact the store from which you purchased it.

Please retain your receipt as proof of purchase.

If you have any comments or suggestions regarding this product, assembly instructions or service

received, please contact the store or Habitat Head Office via its web site: www.habitat.co.uk
or write directly to: Habitat Retail Ltd.
489-499 Avebury Boulevard,
Milton Keynes MK9 2NW

Components - Panels

If you need help or have damaged or missing parts, email: customerservices@habitat.co.uk or call: 0344 499 4686

Please check you have all the panels listed below



Note: There are 'Batch Code' labels where shown on the indicated items, these should be retained.

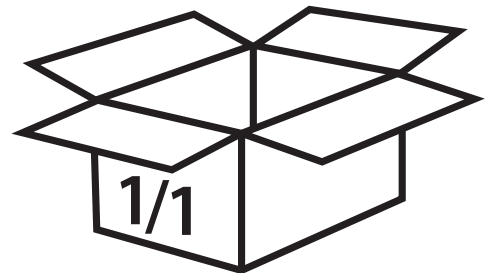
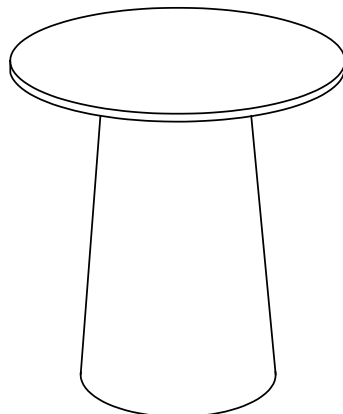
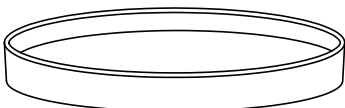
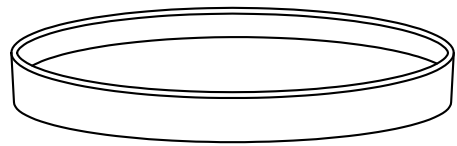
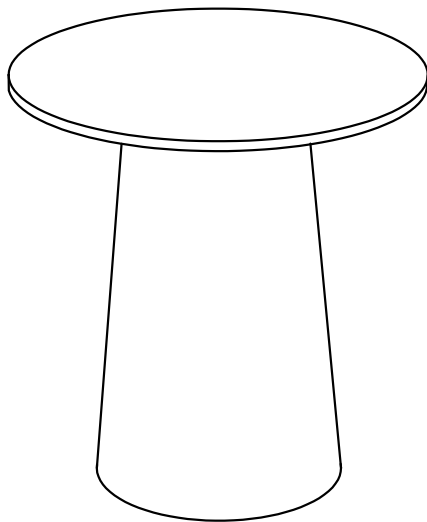

Assembly Instructions

