

BUSH

Instruction manual

Cooker Hood
BACH60B





You'll soon be enjoying your new Cooker Hood

It all begins here, with your instructions. Don't worry, there's nothing too technical coming up. Just simple, step-by-step guidance to get you up and running quickly. Sound good? Then let's get started.

Help and Guidance

We're here to help you get the most from your Cooker Hood. Should you require any guidance, a simple solution can often be found online at:

www.bush-support.com

If you still require further assistance, call one of our experts on **01759 487838**.

Contents

1	Safety information		
	Safety information	6	
2	Getting to know your Cooker Hood		
	Ready? Let's begin	8	
3	Installing your Cooker Hood		
	Installation requirements	12	
	Unpacking	12	
	Mounting instructions	13	
	Attaching and aligning Hood	14	
	Fixing telescopic flue	15	
4	Using your Cooker Hood		
	Use and maintenance	18	
	How to replace charcoal filters	19	
	Cooker hood control panel	19	
5	Care and Maintenance		
	Cleaning		22
	Replacing lamps		22
	Technical specifications		23
6	Product support		
	Troubleshooting		26
	Help and assistance		27
	Declaration of conformance to product standards		28
	Disposal		28
	Guarantee		29

Safety information 1





Safety information

Important - Please read these instructions fully before installing or operating

INSTALLATION WARNINGS

IMPORTANT: This product **MUST** be installed by a qualified installer in accordance with local regulations.

IMPORTANT: Prior to Installation ensure that the local supply conditions (electricity voltage and frequency) are compatible with the requirements of your cooker hood.

IMPORTANT: Carefully unpack and examine the appliance for any damage. If you think there is a defect, do not use the appliance and contact Bush Product Support on 01759 487838. Packaging materials should be collected together and disposed of immediately as they may be harmful to children.

IMPORTANT: Ensure that the electric supply cable is not trapped or damaged during installation.

IMPORTANT: Protect your cooker hood against atmospheric effects. Do not expose your cooker hood to effects such as sun, rain, snow etc.

WARNING: The cooker hood must be mounted on the wall in accordance with the dimensions specified in the mounting diagrams.

DURING USAGE

IMPORTANT: Always replace the aluminium filter of the cooker hood with an original spare part otherwise the suction power may be reduced in addition to the reduction of service life.

WARNING: The LED lamps become hot during use, do not touch the surface.

WARNING: Disconnect the mains power before changing bulbs.

CAUTION: This cooker hood must be kept clean. Oil or residue build up could be a fire hazard.

If you require any technical guidance or find that your product is not operating as intended, a simple solution can often be found in the **Troubleshooting** section of these instructions.

Getting to know your Cooker Hood

2



Getting to know your Cooker Hood

You'll be up and running in no time

Ready? Let's begin...

Please read these instructions carefully. They contain important information which will help you get the best from your Cooker Hood and ensure safe and correct installation and operation.

If you require any further assistance, our technical experts are happy to help. For full details, refer to the product support section at the end of these instructions.

If you require any technical guidance or find that your product is not operating as intended, a simple solution can often be found in the Troubleshooting section of these instructions,

Getting to know your Cooker Hood

You'll be up and running in no time

1. Aluminum Filter
2. Flue
3. Control Buttons
4. LED Lamp

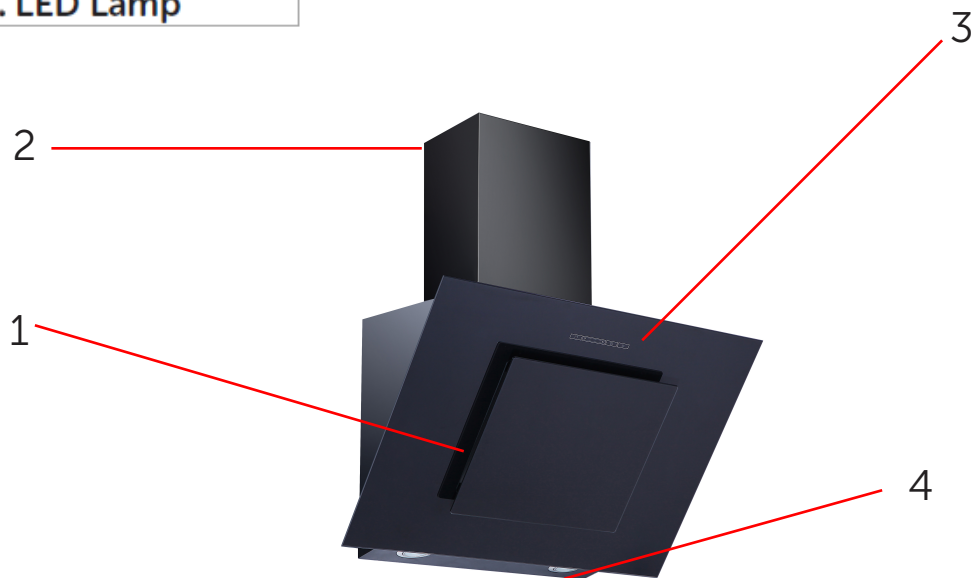

Accessories



1. Fixing Knobs
2. Wall plugs
3. Screws ST4 X 40
4. Washer
5. Screws ST3.5 X 9.5
6. Fixing Bracket
7. Fixing Mount

Installing your
Cooker Hood

3



Installing your Cooker Hood

Bringing it all together

Installation requirements

THIS COOKER HOOD MUST BE INSTALLED BY A COMPETENT PERSON TO LOCAL REGULATIONS

Tools Required For Installation



Electric Drill

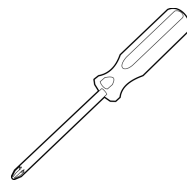

Cross-end and Flat head Screwdriver

Unpacking

Carefully unpack and examine the appliance for any damage. If you think there is a defect, do not use the appliance and contact Product Support on 01759 487838.

Packaging materials should be collected together and disposed of immediately as they may be harmful to children.

PLEASE NOTE: The cooker hood must be installed at a minimum of 65cm above the hob

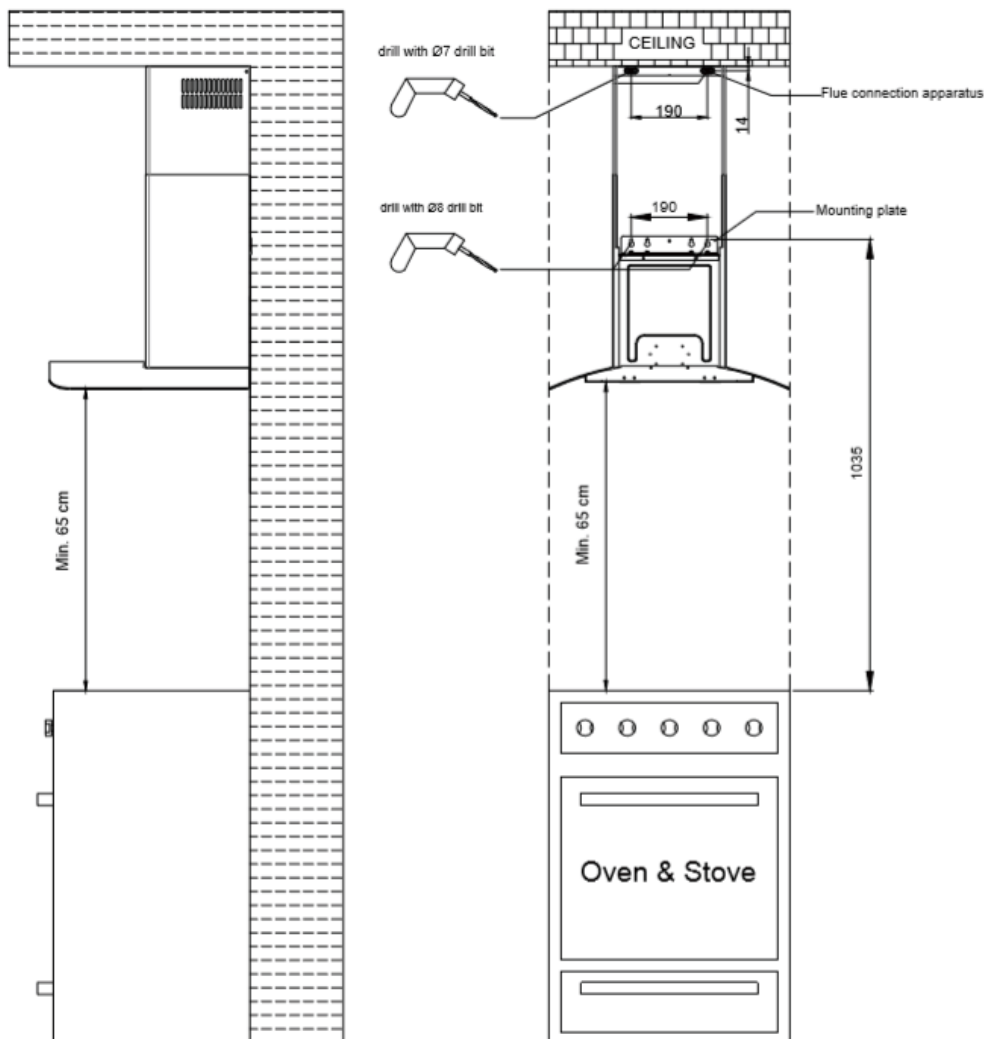

If you require any technical guidance or find that your product is not operating as intended, a simple solution can often be found in the Troubleshooting section of these instructions,

Installing your Cooker Hood

Bringing it all together

Mounting Instructions

Preparing the installation **Caution!**

Ensure that there are no electric wires, gas or water pipes in the area where holes are to be made.

- Mark a vertical centre line on the wall from the ceiling to the lower edge of the cooker hood.
- Mark positions for the screws based on the illustration below.
- Drill five 8 mm diameter holes to a depth of 50 mm for the attachments, and press in the wall plugs (refer to accessories on page 9, part 2) flush with the wall.

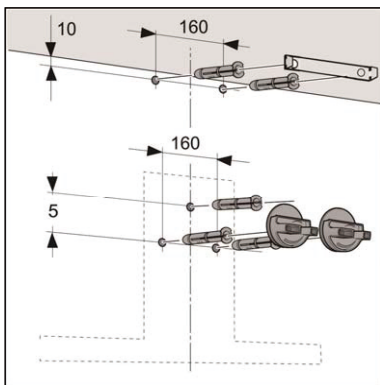

- Using 2 screws and 2 washers, mount the fixing bracket for the flue duct where the top of the wall meets the ceiling. (refer to accessories on page 9, parts 3, 4 and parts 6).

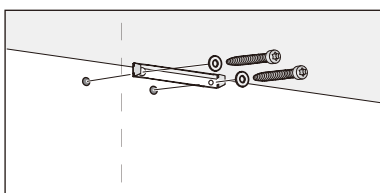

- Using 2 screws mount the fixing knobs for the cooker hood loosely. Do not firmly tighten the screws. (refer to accessories on page 9, part 3).

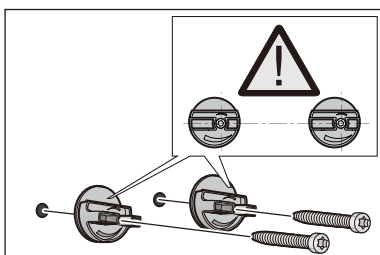

Installing your Cooker Hood

Bringing it all together

Attaching and aligning the appliance.

- Using 4 screws, install the fixing mount to the cooker hood. Ensure the screws are firmly tightened. (refer to accessories on page 9, parts 5 and part 7).

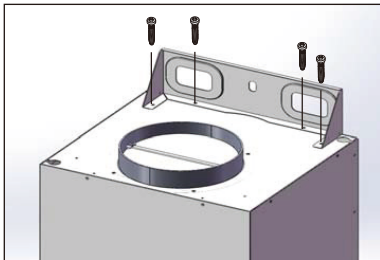

- Place the appliance onto the mounting knobs as illustrated below. You can slightly adjust the appliance location horizontally by moving it right or left until it is centered into the desired location.

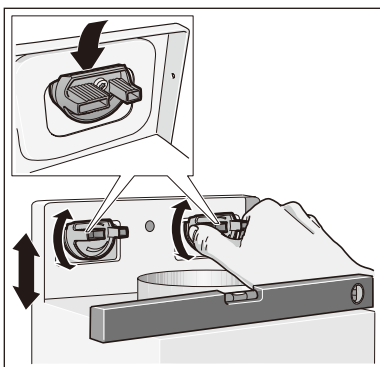

- Now that the appliance is in position, firmly tighten the screws on the fixing knobs.
- Use a screw and washer (refer to accessories on page 9, parts 3 and 4) to install the centre screw through the fixing mount as illustrated below.

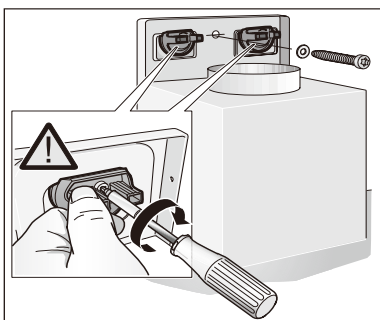

If you require any technical guidance or find that your product is not operating as intended, a simple solution can often be found in the Troubleshooting section of these instructions.

Installing your Cooker Hood

Bringing it all together

For the various installations use screws and screw anchors suited to the type of wall (e.g. reinforced concrete, plasterboard, etc.). If the screws and screw anchors are provided with the product, kindly check the screws are suitable for the type of wall in which the hood is to be fixed.

Fixing the Flue

Arrange the electrical power supply within the dimensions of the flue. If your cooker hood is to be ducted, you will need to engage with a qualified installer. Flexible ducting is not supplied.

This cooker hood can be used without access to outside filtration. Charcoal filters (not supplied) can be fitted to the side of the fan motor. Charcoal filters can be purchased through BUSH product support. (Further instructions provided on page 19). These filters are designed to purify the air and stop the odours and cooking vapors from being expelled into the kitchen.

Place the flue on top of the cooker hood and then slide the inner piece of the flue upwards until it is over the mounting bracket. Use 2 small screws to fix the flue to the mounting bracket. (refer to accessories on page 9, part 5).

Using your Cooker Hood

4



Using your Cooker Hood

Getting the most from your appliance

USE AND MAINTENANCE

It is recommended to operate the appliance prior to cooking.

It is recommended to leave the appliance in operation for 15 minutes after cooking is terminated in order to completely eliminate cooking vapors and odours.

The proper function of the cooker hood is conditioned by the regularity of the maintenance operations, in particular, the charcoal filters (not included). The anti-grease filter captures the grease particles suspended in the air, and are therefore subject to build up of oil and grease depending on how frequently the appliance is used.

In order to prevent fire hazard, it is recommendable to clean the filter every 2 months by carrying out the following instructions:

- Remove the filter from the cooker hood and wash it in a solution of water and neutral liquid detergent, leaving to soak.
- Rinse thoroughly with warm water and leave to dry.
- The filter may also be washed in the dishwasher.

Please take note that the aluminum panels may alter in color after several washes.

If the cooker hood is operating in recirculation mode, (without ducting to the outside air) then charcoal filters must be purchased and regularly replaced. They are not washable or reusable and it is recommended that they are replaced every 4 months.

The saturation of the active charcoal filters depends on the frequency of use of the appliance, and also by the type of cooking and the regularity of cleaning of the anti-grease filters.

To remove the charcoal filters place your hand on one filter at a time and turn it clockwise. The charcoal filter can now be removed. Always ensure that both filters are changed at the same time. (see page 19 for further instructions).

Clean the fan and other surfaces of the cooker hood regularly using a cloth moistened with non abrasive liquid detergent. The cooker hood lighting is designed for use during cooking and not for prolonged general lighting of the kitchen. Prolonged use of the lighting notably reduces the lifetime of the bulb.

Use a flat head screwdriver to lift and remove the overhead light fixture. When replacing a damaged lamp, use only LED lamps, avoiding contact with hands. Return the light fixture to its position using snap fastening. (See page 22 for instructions).

Using your Cooker Hood

Getting the most from your appliance

How to replace the charcoal filters

The charcoal filters are not supplied with appliance. These can be sourced via the BUSH support helpline.

As indicated in the diagram below, push charcoal filter as shown as solid arrow B and twist in an anti-clockwise motion to lock in. Twist in a clockwise motion and pull outwards in the solid A arrow direction to remove filters.

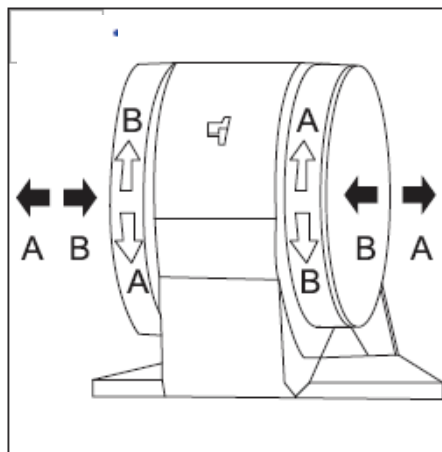

Cooker Hood Control Panel

The cooker hood has a control panel as shown in the image below.

- Power on/off
- Low speed button (decrease fan speed)
- High speed button (increase fan speed)
- Delay off button (will turn cooker hood off after 15 minutes)
- Light button (light on/off)



a b c d e

Care and maintenance 5



Care and maintenance

Looking after your appliance

Cleaning

WARNING! Isolate the power supply to the cooker hood before cleaning the appliance.

Do not clean using caustic creams, abrasive cleaning powders, thick wire wool or hard tools.

Clean the glass surfaces with special glass cleaning agents.

Never use flammable agents like acid, thinner or petrol when cleaning your cooker hood.

Do not clean your cooker hood with a steam cleaner.

Replacing Lamps

To replace the lamps, use a flat head screwdriver to pop the lamp out carefully. See movable parts in image.

For this cooker hood, use LED lamps, the specification is LED 9P, DC12V, 2W MAX. If it cannot be found in the local market, please call 01759 487838.

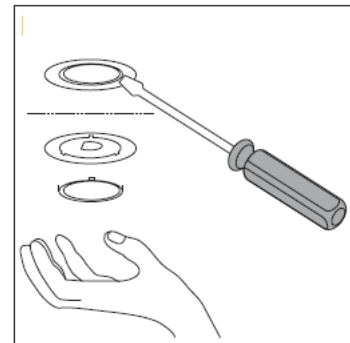

Stainless Steel:

Stainless steel parts must be cleaned frequently with mildly warm soapy water and a soft sponge and then dried with a soft cloth. Do not use abrasive powders or abrasive cleaning materials. Do not leave anything spilled onto stainless steel parts for long periods of time.

Care and maintenance

Looking after your appliance

Technical specification

Touch Controls

198W motor

Extraction and Recirculation options

Aluminum Grease Filter

3 fan speed

2 x LED lights

512m³/h Max extraction

Adjustable chimney height range 400-795mm

Product dimensions 790-1180mm x 600mm x 417mm (HxWxD)

We apologise for any inconvenience caused by minor inconsistencies within these instructions that may occur due to product improvements and development.

All images and drawings are for illustration purposes only.

Product support 6



Product support

Help is always at hand

Troubleshooting

DO NOT ATTEMPT TO REPAIR THIS COOKER HOOD YOURSELF. CALL BUSH PRODUCT SUPPORT ON 01759 487838

Problem	Possible reason	Solution
Hood doesn't work	No electric supply	Check whether the plug is connected
		Check whether the main switch is turned on
Poor airflow	Aluminum grease filters clogged	Clean the filters, assembly back when dry
	Charcoal filters clogged	Replace the charcoal filters
Motor running without air flow	Butterfly valve jammed	Contact technician
After running for a while, motor stop working	High temperature safety device activated	The kitchen is not sufficiently ventilated
	The hood is being installed too near to the cooking stove	The hood must be least 65cm of distance from the stove
Strong cooking smell	Charcoal filters not fitted	In re-circulating mode, charcoal filters must be installed

If you require any technical guidance or find that your product is not operating as intended, a simple solution can often be found in the Troubleshooting section of these instructions.

Product support

Help is always at hand

Help and assistance

If you require any technical guidance or find that your Cooker Hood is not operating as intended, a simple solution can often be found in the Troubleshooting section of these instructions or online at www.bush-support.com

If you still require further assistance, call one of our experts on **01759 487838***. To help give us give you a fast and efficient service please have the following information ready:

Model Ref.	<input type="text"/>	You can find these on the rating plate - a small information panel (usually a sticker or metal plate) on the rear of your appliance
Serial number	<input type="text"/>	
Date of purchase	<input type="text"/>	This will be shown on your receipt

Local call rates applies*

Lines open 8am-7pm Monday to Saturday and 10am-4pm Sunday.

*Calls to Bush enquiry lines may attract a charge and set up fee from residential lines depending on your call plan/tariff. Mobile and other providers costs may vary, see www.bt.com/pricing for details.

For Security and training purposes, telephone calls to and from customer service centres maybe recorded and monitored. Calls from Republic of Ireland will attract international call charges.

Product support

Help is always at hand

Declaration of conformance to product standards

This appliance conforms to all relevant standards applicable to domestic appliances sold in the UK

Disposal



This appliance/fitting is marked according to the European directive 2012/19/EU on Waste Electrical and Electronic Equipment (WEEE).

By ensuring this product is disposed of correctly, you will help prevent potential negative consequences for the environment and human health, which could otherwise be caused by inappropriate waste handling of this product.

The symbol on the product, or on the documents accompanying the product, the **crossed out wheellie bin** symbol, indicates that this appliance/fitting may not be treated as household waste. Instead it shall be handed over to the applicable collection point for the recycling of electrical and electronic equipment.

Disposal must be carried out in accordance with local environmental regulations for waste disposal.

For more detailed information about treatment, recovery and recycling of this product, please contact your local authority, your household waste disposal service or the retailer where you purchased the product.



Call us now and activate your 12 month guarantee

Thank you for choosing Bush. Your new product is guaranteed against faults and breakdowns for 12 months. Don't forget to register it with us today so we can provide you with our best possible after-sales service and useful updates.

www.bushregistration.co.uk

FREEPHONE*

0800 597 8548

Lines are open 8am - 8pm, 365 days a year. *Calls may be recorded and monitored.

Your Bush Guarantee

This product is guaranteed for twelve months from the date of original purchase. Any defect that arises due to faulty materials or workmanship will be repaired free of charge (or if applicable the product will be replaced or the purchase price refunded) where possible during this period by the dealer from who your purchased the unit.

The guarantee is subject to the following provisions:

- The guarantee does not cover accidental damage, misuse, cabinet parts, knobs or consumable items.
- The product must be correctly installed and operated in accordance with the instructions contained in the manual.
- It must be used solely for domestic purposes. The guarantee will be rendered invalid if the product is re-sold or has been damaged by inexpert repair.
- Specifications are subject to change without notice.
- Bush disclaim any liability for loss or damage arising from the breakdown of the product.
- This guarantee is in addition to and does not diminish your statutory or legal rights.

Important Data Protection Information

To find out how we and Domestic & General Insurance Plc use your data please refer to the guarantee registration material or visit www.bushregistrations.co.uk

Guarantor: Argos Limited - 489 - 499 Avebury Blvd. - Milton Keynes - MK9 2NW

BUSH



Contact:

www.bush-support.com

Helpline: 01759 487838