















# ASSEMBLY INSTRUCTIONS/INSTRUCTIONS DE MONTAGE/ INSTRUCCIONES DE MONTAJE/ MONTAGEANLEITUNG/ MONTAGE-INSTRUCTIES

A		5
B		1
C		1
D		1
E		4
F		4
G		2
H		4
I		4
J		1
K		1
L		1
M		1
N		1
O		1

**WARNING**  
PINCH POINT  
MOVING PART CAN  
CRUSH OR CUT.  
KEEP CLEAR

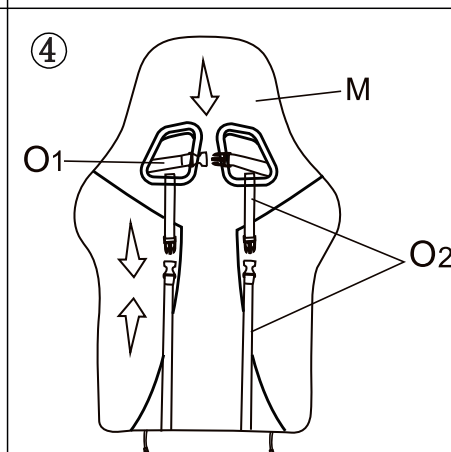
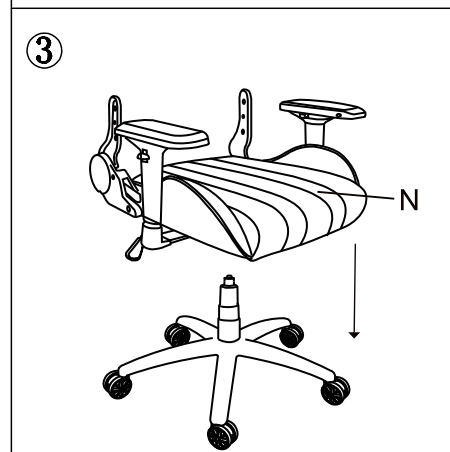
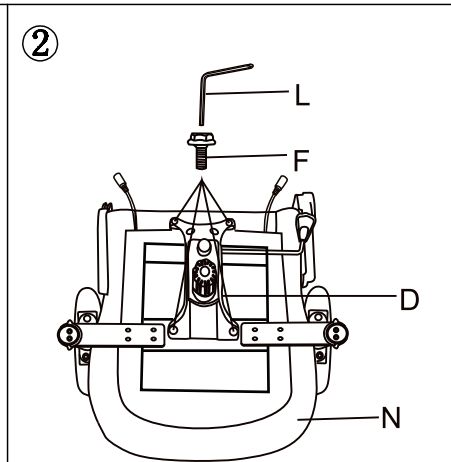
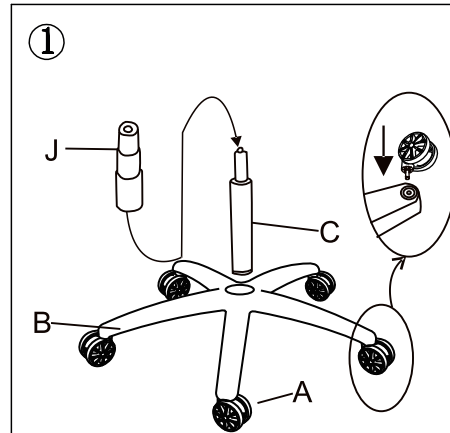
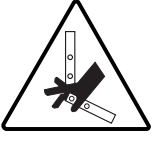

**ATTENTION**  
POINT DE  
PINCEMENTUNE PIÈCE  
MOBILE PEUT ÉCRASER  
OU COUPER.  
GARDER CLAIR



**WARNUNG**  
PINCH POINT  
BEWEGLICHES TEIL  
KANN ZERquetschen  
ODER SCHNEIDEN.  
FREI HALTEN



**WAARSCHUWING**  
KNELPUNT HET  
BEWEGENDE DEEL  
KAN VERPLETLEN  
OF SNIJDEN.  
HOUD DUIDELIJK



**ADVERTENCIA**  
PUNTO DE PELLIZCO  
LA PIEZA EN  
MOVIMIENTO PUEDE  
APLASTARSE O  
CORTARSE.  
MANTENER CLARO



**AVVERTIMENTO**  
PUNTO DI PRESA  
LA PARTE IN  
MOVIMENTO PU CR  
SPACCARE O TAGLIARE.  
LASCIARE LIBERO



IF THERE ARE ANY PARTS MISSING OR YOU NEED FURTHER ASSISTANCE, PLEASE CONTACT US AT [WWW.XROCKERUK.COM/PAGES/SUPPORT](http://WWW.XROCKERUK.COM/PAGES/SUPPORT)  
 S'IL MANQUE DES PIÈCES OU SI VOUS AVEZ BESOIN D'UNE ASSISTANCE SUPPLÉMENTAIRE, VEUILLEZ NOUS CONTACTER À L'ADRESSE [WWW.XROCKERUK.COM/PAGES/SUPPORT](http://WWW.XROCKERUK.COM/PAGES/SUPPORT)  
 WENN TEILE FEHLEN ODER SIE WEITERE HILFE BENÖTIGEN, KONTAKTIEREN SIE UNS BITTE UNTER [WWW.XROCKERUK.COM/PAGES/SUPPORT](http://WWW.XROCKERUK.COM/PAGES/SUPPORT)  
 SI FALTA ALGUNA PIEZA O NECESITA MÁS AYUDA, CONTACTÉNOS EN [WWW.XROCKERUK.COM/PAGES/SUPPORT](http://WWW.XROCKERUK.COM/PAGES/SUPPORT)  
 ALS ER ONDERDELEN ONTBREKEN OF ALS U MEER HULP NODIG HEEFT, NEEM DAN CONTACT MET ONS OP VIA [WWW.XROCKERUK.COM/PAGES/SUPPORT](http://WWW.XROCKERUK.COM/PAGES/SUPPORT)  
 SE MANCANO PARTI O SE HAI BISOGNO DI ULTERIORE ASSISTENZA, CONTATTACI SU [WWW.XROCKERUK.COM/PAGES/SUPPORT](http://WWW.XROCKERUK.COM/PAGES/SUPPORT)

# ASSEMBLY INSTRUCTIONS/INSTRUCTIONS DE MONTAGE/ INSTRUCCIONES DE MONTAJE/ MONTAGEANLEITUNG/ MONTAGE-INSTRUCTIES

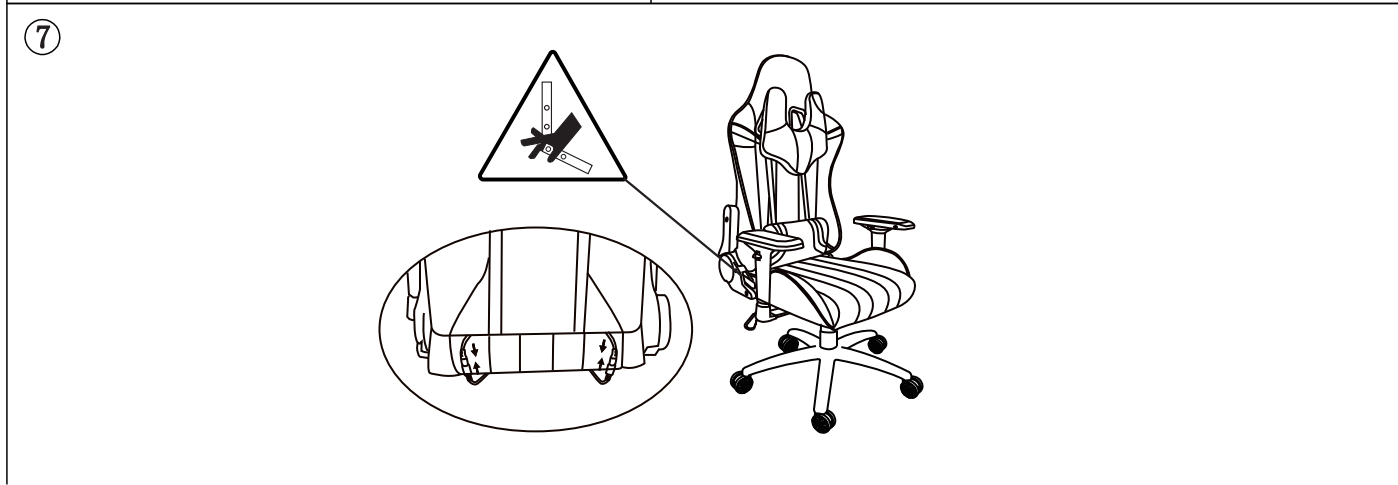
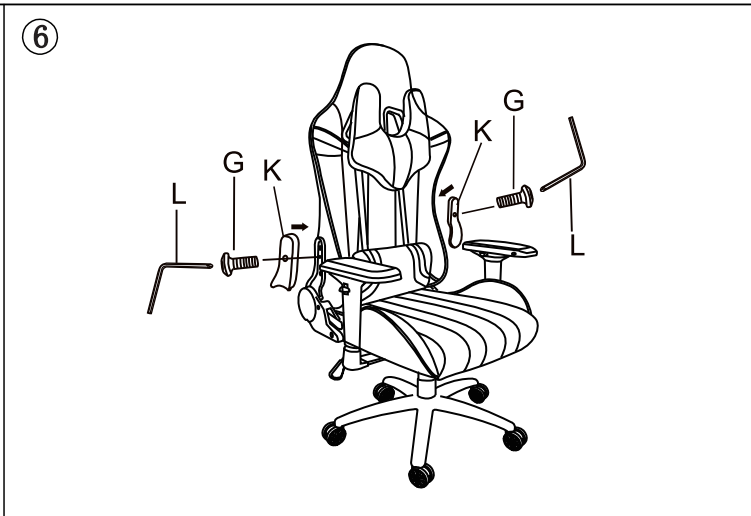
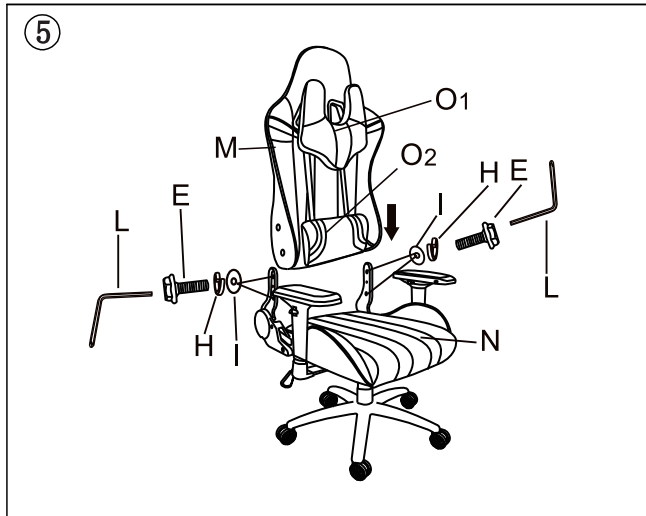

## ⚠ Warning!

Chair arms are for gaming support only. To avoid damage or injury, do not sit on the arms. Do not use arms to EXIT from the chair or to MOVE or LIFT the chair.

## ⚠ Avertissement !

Les accoudoirs du fauteuil sont conçus uniquement pour être utilisés comme éléments de soutien lorsque vous jouez. Pour éviter d'endommager le fauteuil ou de vous blesser, ne vous asseyez pas sur les accoudoirs. N'utilisez pas les accoudoirs pour vous LEVER du fauteuil ou pour DÉPLACER ou SOULEVÉ le fauteuil.

## ⚠ Avvertimento !

Le braccia della sedia sono solo per il supporto di gioco. Evitare danni o lesioni, non sedersi sulle braccia. Non usare le braccia per USCIRE dalla sedia o spostare o sollevare la sedia.

## ⚠ ¡Advertencia!

Los reposabrazos de la silla deben utilizarse únicamente como apoyo durante el juego. Para evitar daños o lesiones, no se sienten sobre los reposabrazos. No utilice los reposabrazos para LEVANTARSE de la silla ni para MOVER o LEVANTAR la silla.

## ⚠ Warnung !

Die Armlehnen sind nur zur Unterstützung beim Spielen bestimmt. nicht, um aus dem Sessel AUFZUSTEHEN, um den Sessel zu BEWEGEN oder HOCHZUHEBEN.

## ⚠ Waarschuwing!

Stoelarmen zijn alleen bedoeld voor gaming-ondersteuning. Ga niet op de armen zitten om schade of letsel te voorkomen. Gebruik de armen niet om uit de stoel OP TE STAAN of om de stoel te VERPLAATSEN of TE TILLEN.

**XRocker**

IF THERE ARE ANY PARTS MISSING OR YOU NEED FURTHER ASSISTANCE, PLEASE CONTACT US AT [WWW.XROCKERUK.COM/PAGES/SUPPORT](http://WWW.XROCKERUK.COM/PAGES/SUPPORT)

SI IL MANQUE DES PIÈCES OU SI VOUS AVEZ BESOIN D'UNE ASSISTANCE SUPPLÉMENTAIRE, VEUILLEZ NOUS CONTACTER À L'ADRESSE [WWW.XROCKERUK.COM/PAGES/SUPPORT](http://WWW.XROCKERUK.COM/PAGES/SUPPORT)

WENN TEILE FEHLEN ODER SIE WEITERE HILFE BENÖTIGEN, KONTAKTIEREN SIE UNS BITTE UNTER [WWW.XROCKERUK.COM/PAGES/SUPPORT](http://WWW.XROCKERUK.COM/PAGES/SUPPORT)

SI FALTA ALGUNA PIEZA O NECESITA MÁS AYUDA, CONTACTÉENOS EN [WWW.XROCKERUK.COM/PAGES/SUPPORT](http://WWW.XROCKERUK.COM/PAGES/SUPPORT)

ALS ER ONDERDELEN ONTBREKEN OF ALS U MEER HULP NODIG HEEFT, NEEM DAN CONTACT MET ONS OP VIA [WWW.XROCKERUK.COM/PAGES/SUPPORT](http://WWW.XROCKERUK.COM/PAGES/SUPPORT)

SE MANCANO PARTI O SE HAI BISOGNO DI ULTERIORE ASSISTENZA, CONTATTACI SU [WWW.XROCKERUK.COM/PAGES/SUPPORT](http://WWW.XROCKERUK.COM/PAGES/SUPPORT)

