















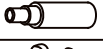

ASSEMBLY INSTRUCTIONS/INSTRUCTIONS DE MONTAGE/ INSTRUCCIONES DE MONTAJE/ MONTAGEANLEITUNG/ MONTAGE-INSTRUCTIES

A		5
B		1
C		1
D		1
E		4
F		4
G		2
H		4
I		4
J		1
K		1
L		1
M		1
N		1
O		1

WARNING
PINCH POINT
MOVING PART CAN
CRUSH OR CUT.
KEEP CLEAR

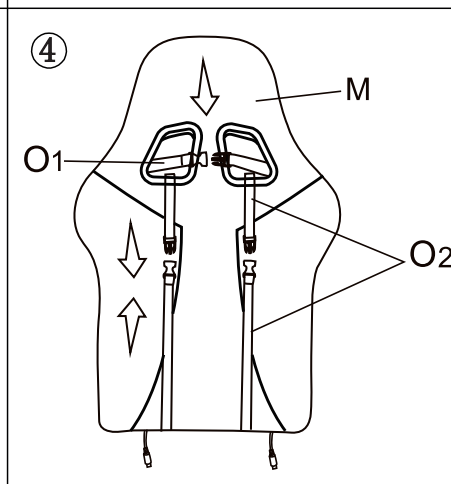
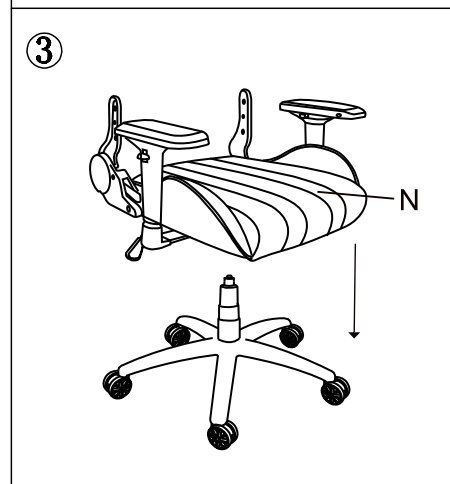
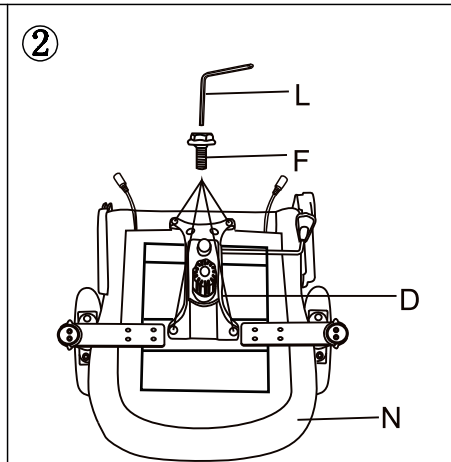
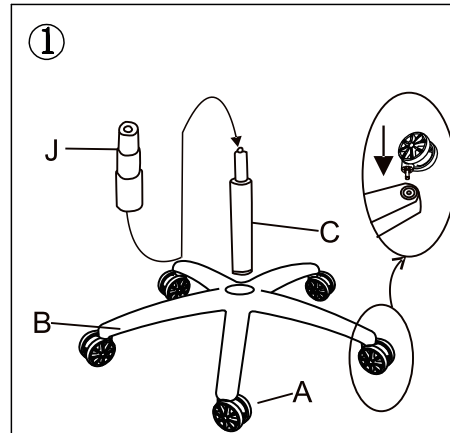

ATTENTION
POINT DE
PINCEMENTUNE PIÈCE
MOBILE PEUT ÉCRASER
OU COUPER.
GARDER CLAIR



WARNUNG
PINCH POINT
BEWEGLICHES TEIL
KANN ZERquetschen
ODER SCHNEIDEN.
FREI HALTEN



WAARSCHUWING
KNELPUNT HET
BEWEGENDE DEEL
KAN VERPLETLEN
OF SNIJDEN.
HOUD DUIDELIJK



ADVERTENCIA
PUNTO DE PELLIZCO
LA PIEZA EN
MOVIMIENTO PUEDE
APLASTARSE O
CORTARSE.
MANTENER CLARO



AVVERTIMENTO
PUNTO DI PRESA
LA PARTE IN
MOVIMENTO PU CR
SPACCARE O TAGLIARE.
LASCIARE LIBERO



IF THERE ARE ANY PARTS MISSING OR YOU NEED FURTHER ASSISTANCE, PLEASE EMAIL: SERVICE@XROCKERNATION.CO.UK
 SI FALTAN PIEZAS O NECESITA MÁS AYUDA, POR FAVOR EMAIL: SERVICE@XROCKERNATION.CO.UK
 S'IL Y A DES PIÈCES MANQUANTES OU SI VOUS AVEZ BESOIN D'AIDE, VEUILLEZ EMAIL: SERVICE@XROCKERNATION.CO.UK
 WENN TEILE FEHLEN ODER SIE WEITERE HILFE BENÖTIGEN, EMAIL: SERVICE@XROCKERNATION.CO.UK
 ALS ER ONDERDELEN ONTBREKEN OF ALS U MEER HULP NODIG HEBT, U EMAIL: SERVICE@XROCKERNATION.CO.UK

ASSEMBLY INSTRUCTIONS/INSTRUCTIONS DE MONTAGE/ INSTRUCCIONES DE MONTAJE/ MONTAGEANLEITUNG/ MONTAGE-INSTRUCTIES

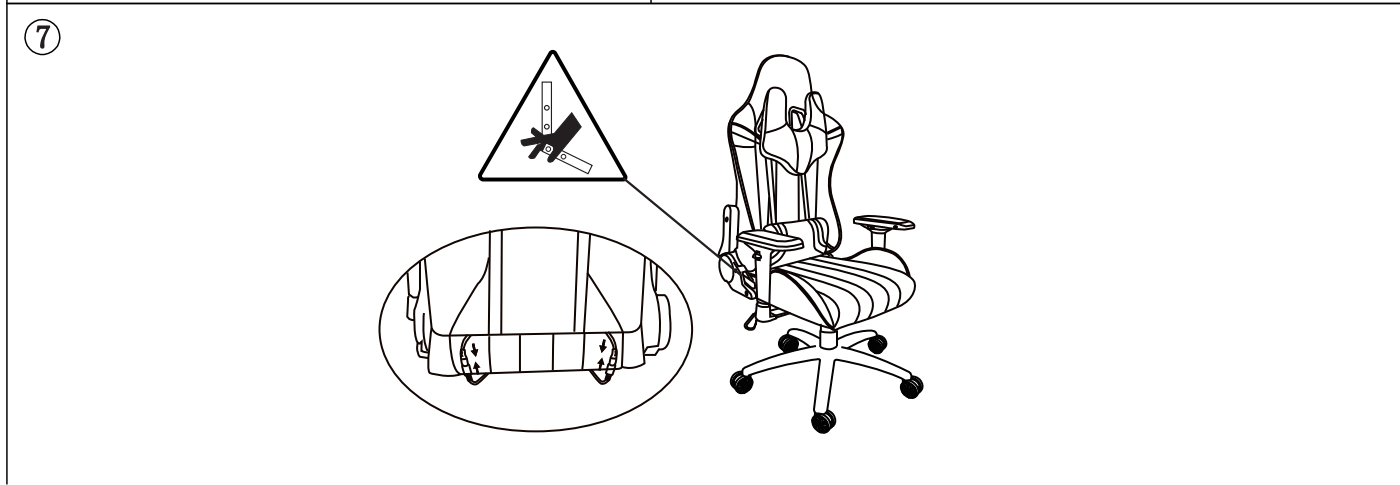
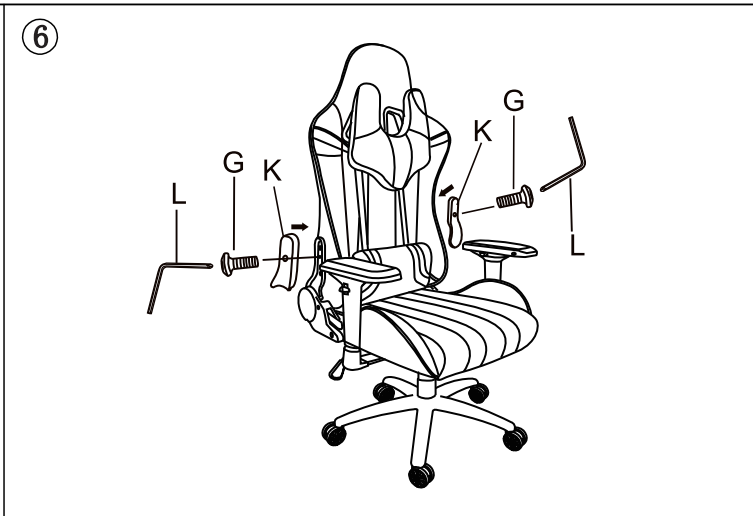
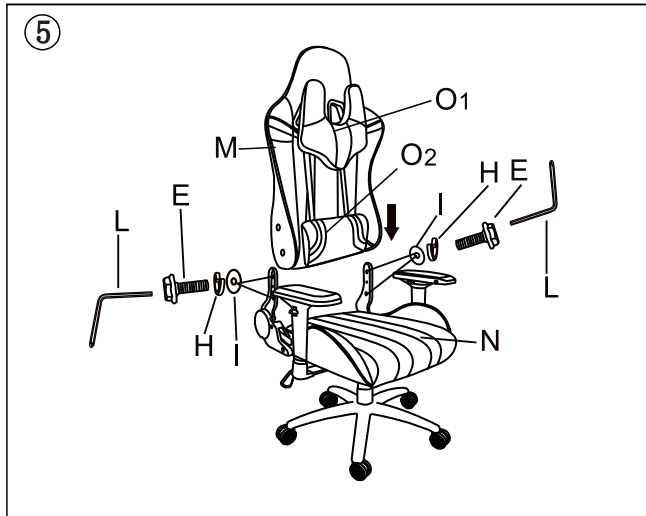

⚠ Warning!

Chair arms are for gaming support only. To avoid damage or injury, do not sit on the arms. Do not use arms to EXIT from the chair or to MOVE or LIFT the chair.

⚠ Avertissement !

Les accoudoirs du fauteuil sont conçus uniquement pour être utilisés comme éléments de soutien lorsque vous jouez. Pour éviter d'endommager le fauteuil ou de vous blesser, ne vous asseyez pas sur les accoudoirs. N'utilisez pas les accoudoirs pour vous LEVER du fauteuil ou pour DÉPLACER ou SOULEVÉ le fauteuil.

⚠ Avvertimento !

Le braccia della sedia sono solo per il supporto di gioco. Evitare danni o lesioni, non sedersi sulle braccia. Non usare le braccia per USCIRE dalla sedia o spostare o sollevare la sedia.

⚠ ¡Advertencia!

Los reposabrazos de la silla deben utilizarse únicamente como apoyo durante el juego. Para evitar daños o lesiones, no se sienten sobre los reposabrazos. No utilice los reposabrazos para LEVANTARSE de la silla ni para MOVER o LEVANTAR la silla.

⚠ Warnung !

Die Armlehnen sind nur zur Unterstützung beim Spielen bestimmt. nicht, um aus dem Sessel AUFZUSTEHEN, um den Sessel zu BEWEGEN oder HOCHZUHEBEN.

⚠ Waarschuwing!

Stoelarmen zijn alleen bedoeld voor gaming-ondersteuning. Ga niet op de armen zitten om schade of letsel te voorkomen. Gebruik de armen niet om uit de stoel OP TE STAAN of om de stoel te VERPLAATSEN of TE TILLEN.

XRocker

IF THERE ARE ANY PARTS MISSING OR YOU NEED FURTHER ASSISTANCE, PLEASE EMAIL: SERVICE@XROCKERNATION.CO.UK
 SI FALTAN PIEZAS O NECESITA MÁS AYUDA, POR FAVOR EMAIL: SERVICE@XROCKERNATION.CO.UK
 S'IL Y A DES PIÈCES MANQUANTES OU SI VOUS AVEZ BESOIN D'AIDE, VEUILLEZ EMAIL: SERVICE@XROCKERNATION.CO.UK
 WENN TEILE FEHLEN ODER SIE WEITERE HILFE BENÖTIGEN, EMAIL: SERVICE@XROCKERNATION.CO.UK
 ALS ER ONDERDELEN ONTBREKEN OF ALS U MEER HULP NODIG HEBT, U EMAIL: SERVICE@XROCKERNATION.CO.UK

