

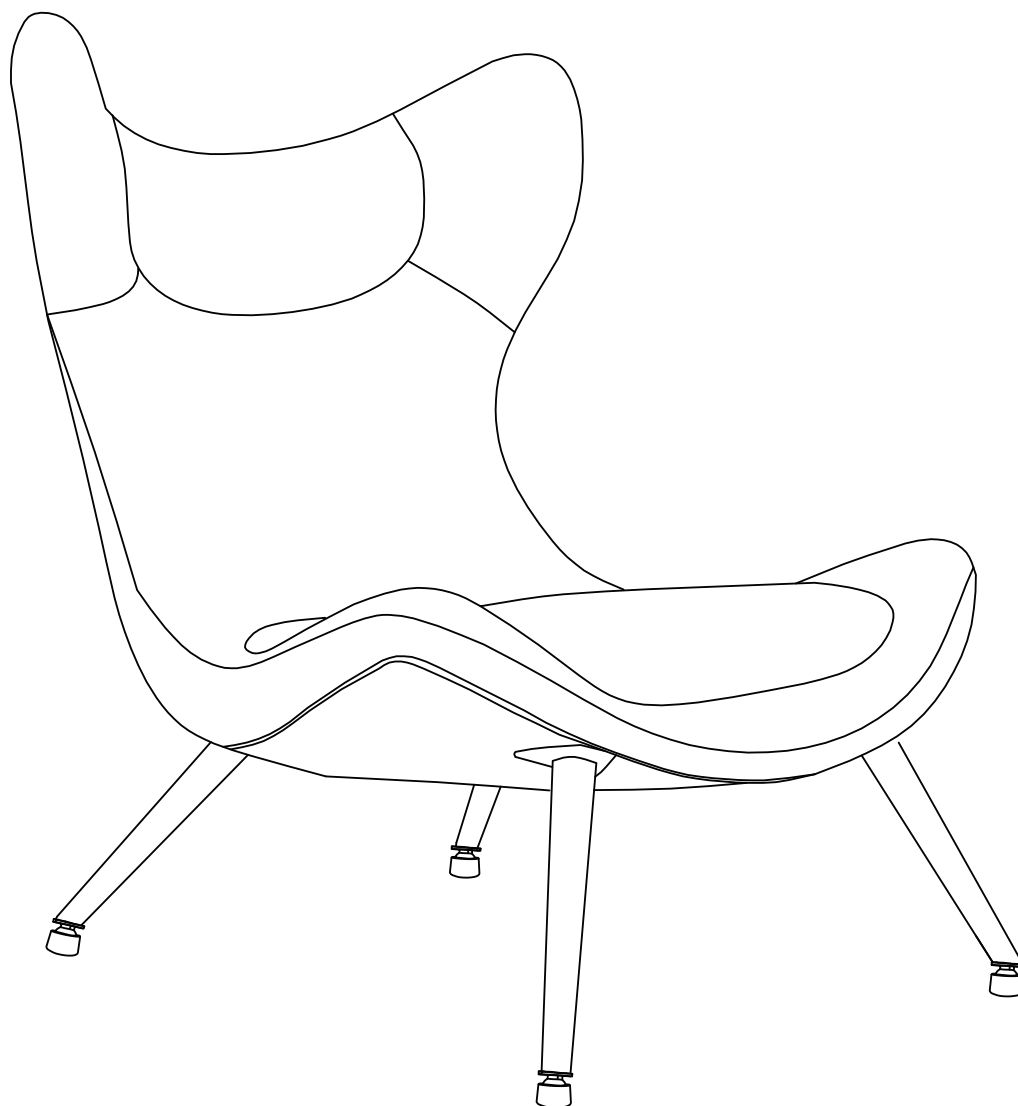

Robbie

habitat

Angel wing chair



Spare Parts

 www.argos-support.co.uk

 Help@ClickSpares.co.uk

 0370 112 1928

Customer Support

 0345 640 2020

Components

①



Seat cushion X 1

②

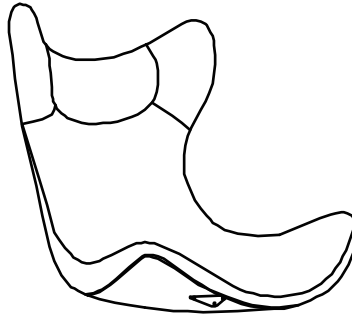

Body X 1

③

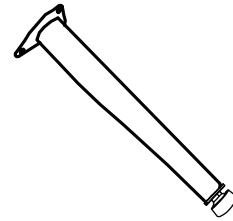

Front leg X 2

④

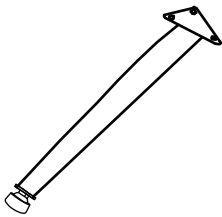

Back leg X 2



Safety and Care Advice

Product Details

913/4362 ROBBIE ANGEL WING CHAIR GREY

IMPORTANT, RETAIN FOR FUTURE REFERENCE: READ CAREFULLY.

- Keep children and animals away from the work area, small parts could choke if swallowed.
- Assemble the item as close to its final position (in the same room) as possible.
- Assemble on a soft level surface to avoid damaging the unit or your floor.
- We do not recommend the use of power drill/drivers for inserting screws as this could damage the unit. Only use hand screwdrivers.
- Parts of the assembly will be easier with 2 people.
- Dispose of all packaging carefully and responsibly.

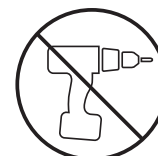

Care and maintenance

- Only clean using a damp cloth and mild detergent. Do not use abrasive cleaners.
- Use a dry cloth to clean the product, furniture polish is not recommended.
- From time to time check that there are no loose screws, nuts or bolts. If there are please re-tighten.
- This product should not be discarded with household waste. Take to your local authority waste disposal centre.

Additional Guidance

- Assemble all parts and bolts loosely during assembly, only once the product is complete should you fully tighten the bolts.
- Regularly check and ensure that all bolts and fittings are tightend properly.
- Age recommendation for upper bunk 6+
- Maximum user weight 110kg/per seat
- This product is compliant EN12520

Fittings

A x 12



M8x20 mm

B x 1

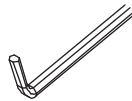

1

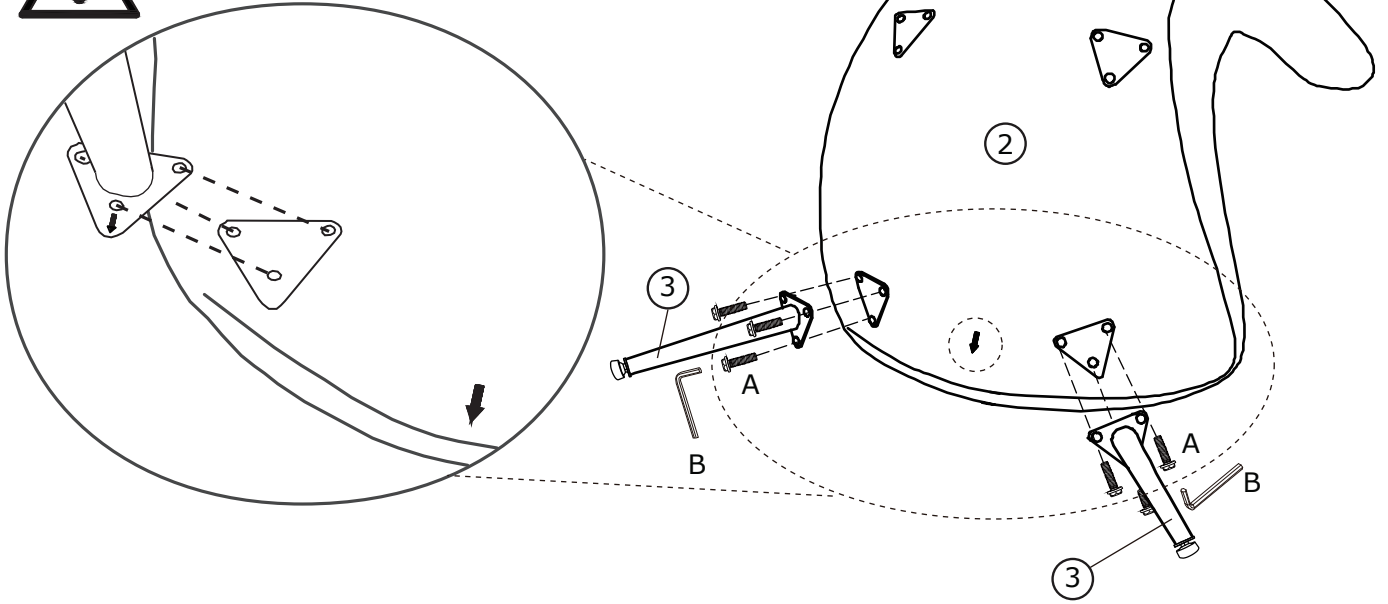
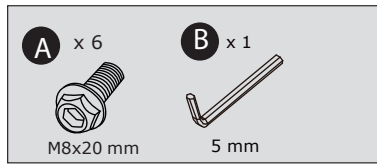
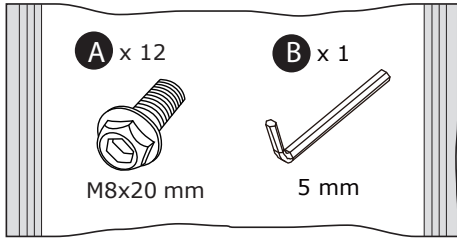

2

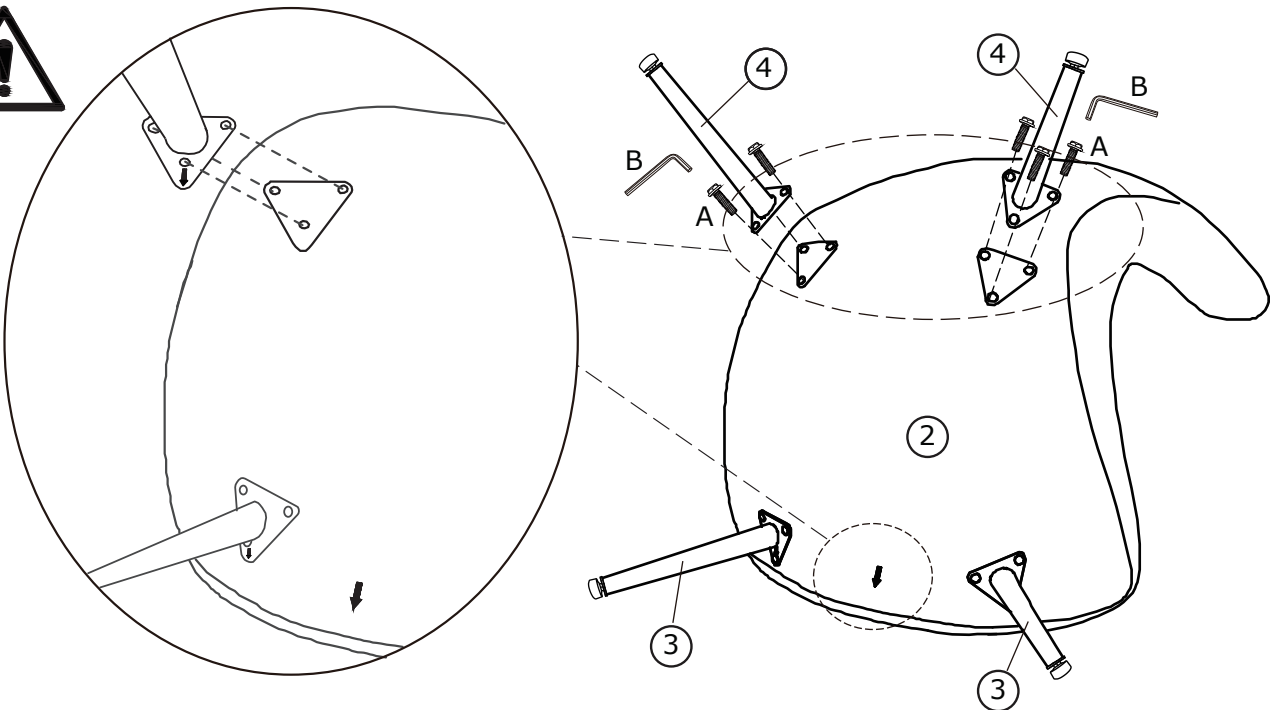
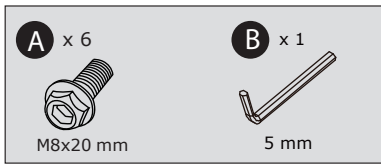

3

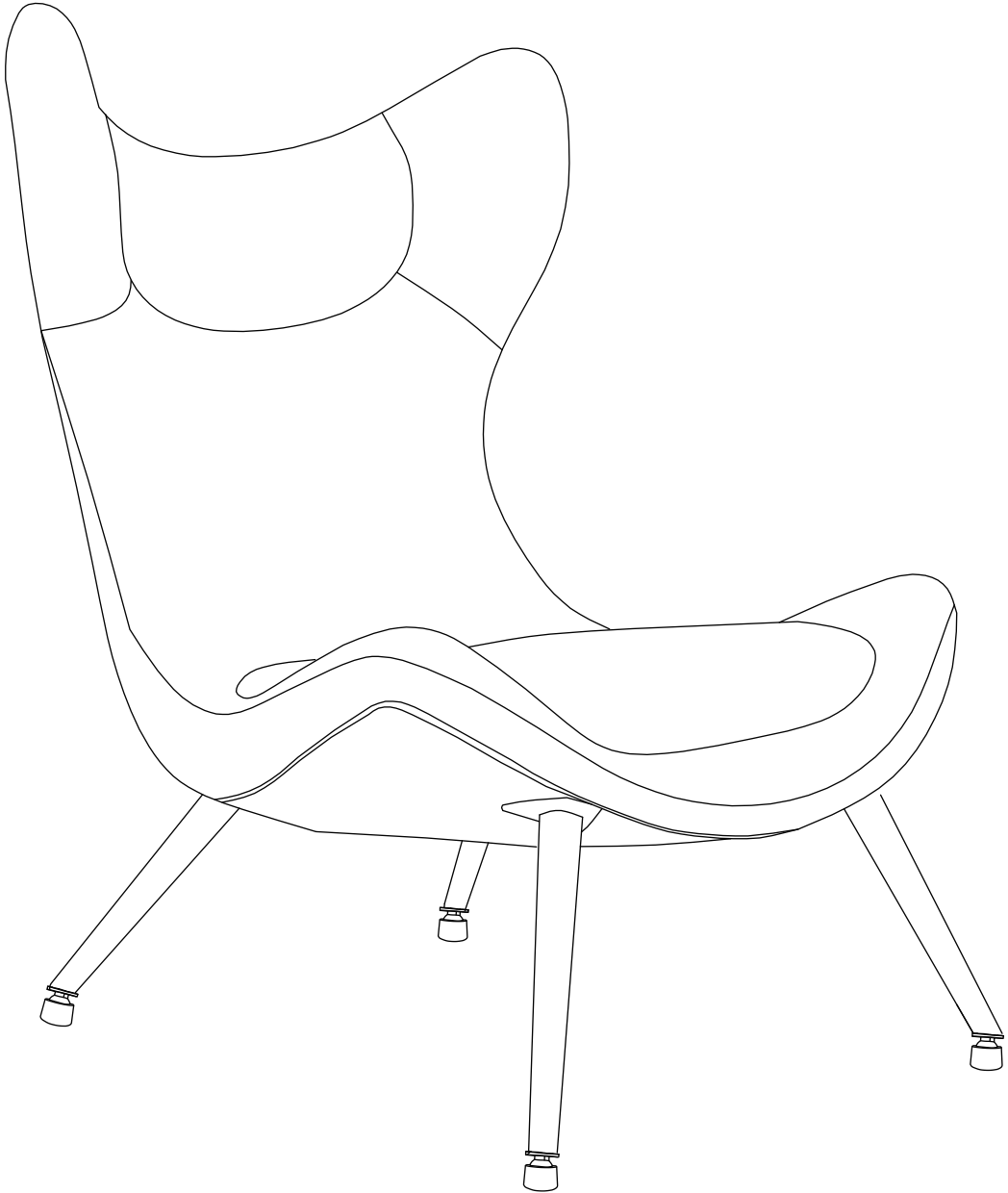

Sainsburys Argos Upholstery Care Guide

The below advice is to help you maintain your sofa to ensure you can get the very best out of it.

Once you have received your sofa please reshape and plump the cushions back to their original shape, it may take a few days for any creases to drop out.

Cushion Care

Your Cushions will soften over time, to maximise your comfort and the life of the cushions follow the advice below

Fibre - Fibre Cushions need to be cared for daily. It is recommended that they are plumped by shaking and squeezing to even out the fibres every day. This will provide longer lasting comfort and life.

Foam – Foam cushions will naturally soften within the first few weeks. To ensure even wear swap cushions around from favourite seat locations and flip them where possible.

General Care Advise

- Vacuum clean your upholstery at least once a week, dust removal may be improved by pre-brushing with a soft cloth.
- Chenille, velour and velvets may flatten in use, crush marks and random shading will occur. This is a normal characteristic of this fabric.
- Periodically check and re-tighten feet where required.
- Keep upholstery out of direct sunlight to avoid discolouring.
- Do not place the furniture in a conservatory, excessively dry or humid conditions.
- Avoid sharp items such as toys, jean rivets and buckles coming into contact with the upholstery as these can easily snag, tear or pull the fabric.
- To maintain the appearance and durability of your suit, restrain children and pets from climbing and jumping on the sofa.
- Leather is a natural product and can display natural marks and characteristics such as healed scars, grain directions and creases. These are natural features not faults. Please dust leather regular and clean with a damp cloth.

For accidental spills or stains

Do's

- Do blot or soak up spills immediately using a dry soft colourfast cloth
- Do use specialist upholstery cleaner if needed, always follow the manufacturer's instructions and always conduct a path test.

Don'ts

- Don't rub or scrub with a cloth as this could damage the fabric and remove the colour
- Don't use washing up liquid, detergents or bleach to remove stains
- Don't soak or allow fabric to become wet