

ProAction – Paper Shredder

Installation & User Instructions – Please keep for future reference

913/0328

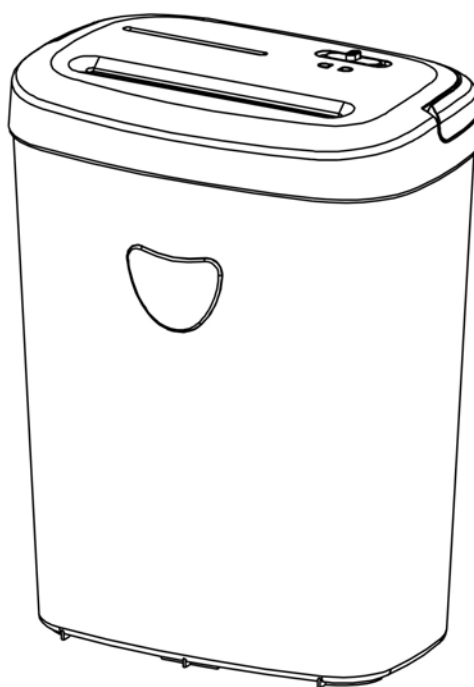

Important – Please read these instructions fully before installing or using

These instructions contain important information which will help you get the best from your appliance and ensure safe and correct installation, use and maintenance.

If you need help or have damaged or missing parts, call the Customer Helpline: 0345 640 0800

Contents

Safety Information	2
Parts	3
Installation	4-5
Location	4
Electrical Connection	5
User Instructions	6-7
Before first use	6
Using your appliance	6
Care and Maintenance	8
General	8
Trouble Shooting	8
Technical Specifications	9
Disposal information	9
Guarantee	10



Product codes

VS1208CD



Safety Information

Important – Please read these instructions fully before installation

Before use

- Dispose of all packaging carefully and responsibly.
- The appliance is designed for **indoor use only**. **Do not** use outdoor.
- This appliance is designed for household use.
- **Do not** use the appliance for industrial and commercial use, or any other purpose.
- The appliance **MUST** be positioned on a firm level base.
- Please use the shredder with a correct power supply.
- **Do not** use appliance for other than intended use.
- Keep the power cord away from hot surface.
- **Do not** immerse the machine in water or any other liquid to protect against electric shock.
- Keep children away from the machine. This machine should be operated by adults only.
- Please don't spray any flammable gas or oil on this shredder, it may cause a fire.
- **Do not** allow this appliance to be exposed to rain or moisture.
- Please unplug the shredder when emptying the waste bin or non-in use or moving the shredder.

During use

- **WARNING!** Keep all loose articles of clothing, ties, jewellery, long hair or other loose objects away from opening, injury may result!
- Never insert fingers into opening. Serious injury may result!
- Please keep soft cloths and ties far away from the paper entry.
- Please keep your hair far away from the shredder.
- Always operate on a flat horizontal surface.
- This appliance is not intended for use by persons (including children) with reduced physical, sensory or mental capabilities, or lack of experience and knowledge, unless they have been given supervision or instruction concerning use of the appliance by a person responsible for their safety. Children should be supervised to ensure that they do not play with the appliance.
- This appliance is not intended for use by young children or infirm persons unless they have been adequately supervised by a responsible person to ensure that they can use the appliance safely. Young children should be supervised to ensure that they do not play with the appliance.
- **Do not** operate the appliance with a damaged cord or plug or after the appliance malfunctions, or has been damaged in any manner.
- **Do not** attempt to repair the appliance yourself. Contact the Customer Helpline: 0345 640 0800

Part

Please familiarize yourself with the parts and accessories listed below

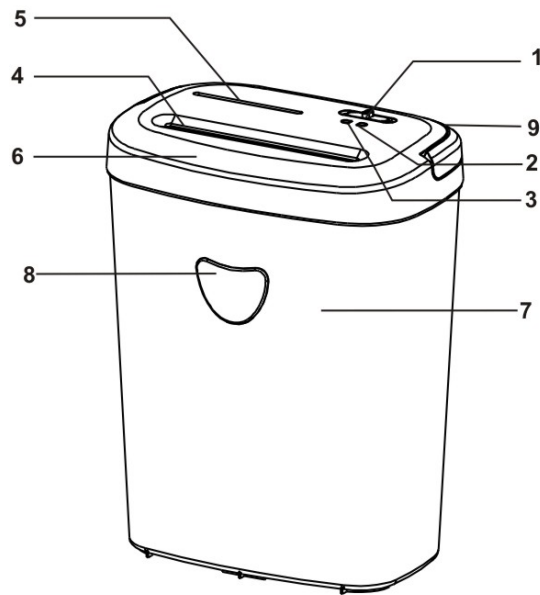

- 1. Function switch (Auto, Off, Rev)
- 2. Power indicator
- 3. Overheat indicator
- 4. Paper in throat
- 5. CD in throat

- 6. Main unit
- 7. Waste bin
- 8. Viewing windows
- 9. Power ON/OFF switch

Accessories included

ProAction - Paper Shredder



Instructions x 1

Instructions x 1

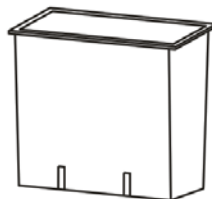

Small bin for CD X 1

Installation

Location



Caution: Always operate this product on a flat horizontal surface.

- Carefully remove all packaging materials and dispose of correctly.
- Ensure the supply cable is not caught under the appliance.
- Do not operate under or near curtains or other combustible materials
- Do not place the appliance near a heat source or in direct sunlight.

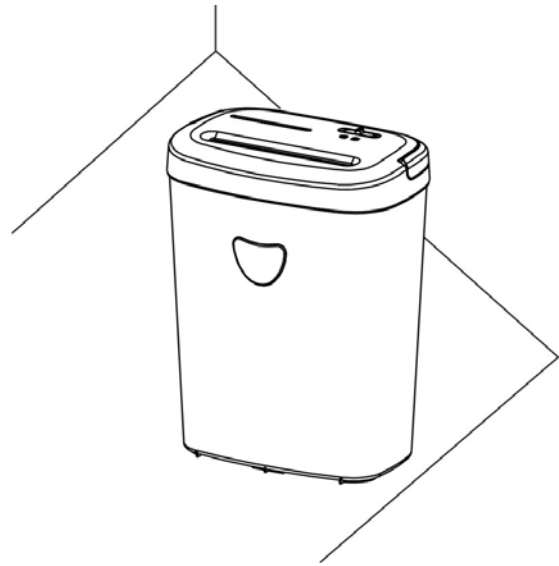

Installation

Electrical connection



Any electrical work that is required to install this appliance **MUST** be carried out by a qualified electrician.

Before making any electrical connections, ensure that:

- Do not bend, stretch or pull the supply cable to avoid electric shock.
- Ensure the power socket is suitable for the maximum power of the machine.
- The supply voltage should be the same as that indicated in the technical specifications and the appliance rating plate.
- If the socket outlets in your home are not suitable for the plug supplied with this unit check with a qualified electrician for replacement.
- The use of adapters, multiple connectors or extension cables are not recommended.
- The appliance must be connected to a 220-240 volt 50Hz AC supply by means of a three pin socket, suitably earthed and protected by a 5 amp fuse.
- Should the fuse need to be replaced, a 5 amp fuse approved to BS1362 must be used.
- The plug contains a removable fuse cover that must be refitted when the fuse is replaced. If the fuse cover is lost or damaged, the plug must not be used until a replacement cover has been fitted or the plug is replaced.
- A damaged plug should be cut off as close to the plug body as possible, the fuse should be removed and the plug disposed of safely.

Plug replacement (UK & Ireland only)

Should you need to replace the plug; the wires in the power cable are coloured in the following way:

Blue – Neutral 'N'

Brown – Live 'L'

As the colours of the wires in the power cable may not correspond with the coloured markings identifying the terminals in your plug, and proceed as follows:

The blue wire must be connected to the terminal that is marked with the letter N.

The brown wire must be connected to the terminal that is marked with the letter L.

If power supply cord is damaged, it must be replaced by the manufacturer or its service agent or a similar qualified person in order to avoid a hazard.

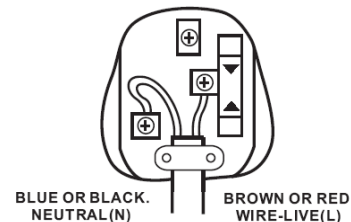

User Instructions

Before first use

Setting up the shredder

1. Remove the shredder from the packaging and unwind the cord to its full length.
2. Place the waste bin on a firm level surface in a stable upright position.
3. Put the small bin into the slot inside the waste bin.
4. This appliance is equipped with a safety system. If the shredder head and waste bin are not correctly in place, the appliance will not function.
5. Take the main unit and put it onto the waste bin.
6. Make sure both power switch and function switch is in "OFF" position.
7. Connect the plug to the 220-240V AC mains.

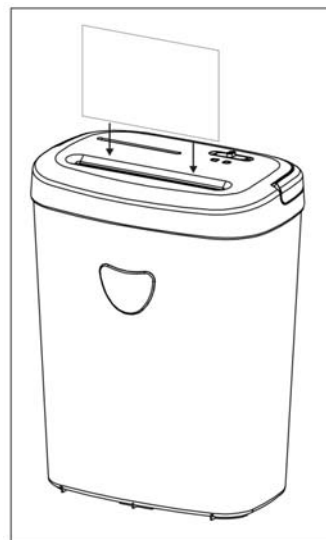
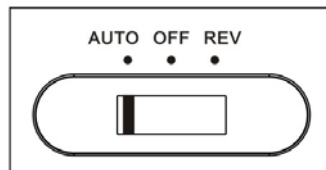
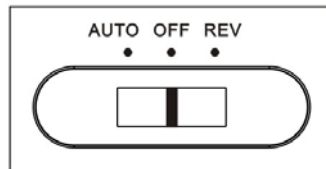
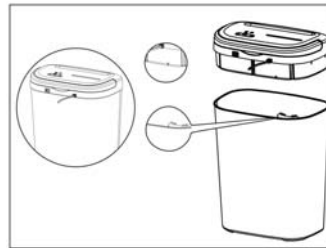
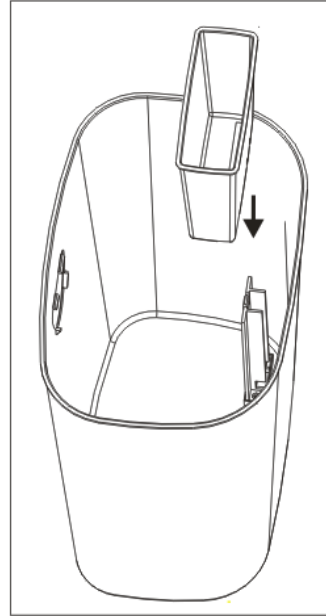

Using your appliance

1. AUTO mode

- Turn the Power ON/OFF switch to "ON" position.
- To use this mode, turn the function switch to "Auto".
- Feed the paper into the paper in-throat or put the CD in, the micro-switch in the throat will be pressed.
- The shredder will operate to shred the paper / CD.
- Once all the papers / CD have been shredded, it will stop itself.
- When the motor is over heated, the machine will be shut off automatically, after a cool down time of 30 minutes around, the machine can be started working again.



NOTE: The maximum paper can be fed are 12 sheets. Should the shredder be overfed, it will stop working due to paper jam.

OVERHEAT SAFETY DEVICE

Your shredder is fitted with a safety device that switches off the unit in event of overload. Should the unit stop working, turn the unit off and unplug from the mains. Allow the motor to cool down to room temperature (approx. 30mins) before resuming operation.

If the unit fails to operate or the safety device switches the unit off again, return the unit to your nearest service center for examination or repair.

User Instructions

Using your appliance

2. OFF MODE

- To switch off the shredder, turn the function switch to “OFF” position.

3. REVERSE mode

- Turn the function switch to “REV” position.
- The cutting blade in shredder will run in reverse direction.

Paper jam

- Turn the function switch to “REV” position to let the cutting blade running in reverse direction. Then the paper will come out from the throat.
- Pull out the paper carefully to clear the throat.
- Once the jammed paper is removed, turn the function switch to “AUTO” position for normal operation.

Empty the waste bin

- Switch off the unit and disconnect from the AC mains.
- Remove the main unit from the bin and put on the floor.
- Empty the bin.
- Place the bin on the floor after empty and put the main unit back. Make sure it is positioning in good condition.
- Connect to the AC mains.



Note: Always empty the bin while it is full to avoid hazard.

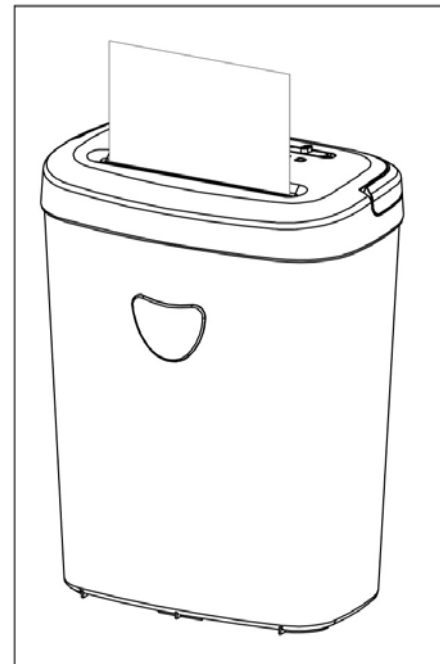
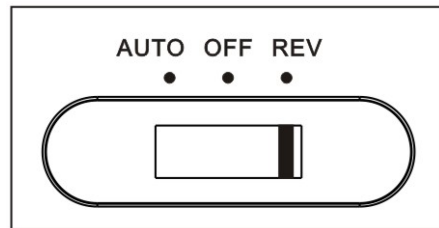
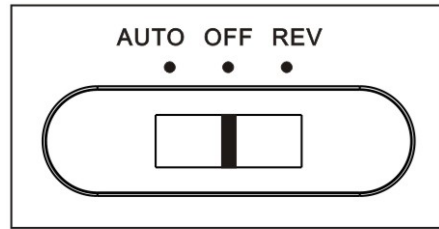

Care and Maintenance

General



Important: Always unplug the appliance from the power socket during cleaning and maintenance.

- Never use any sharp instruments or abrasive substances, soap, household cleaner, detergent or wax polish for cleaning.
- Use luke warm water to clean the cabinet of the appliance and wipe it dry.
- Never clean the appliance with flammable fluids. It could cause a damage and fire hazard.
- Ensure the unit is dry before connect to the mains.

Trouble Shooting

In the unlikely event of difficulties with your appliance please follow the trouble shooting guide below. If the problem persists, contact the retailer if the machine is still under guarantee on **0345 640 0800**

Problem	Possible cause	Solution
Appliance does not start	<ul style="list-style-type: none">• The mains plug is not plugged in.• Fuses of the electrical system at home open.• Power ON/OFF switch in "OFF" position.• Overheat protection device is activated.	<ul style="list-style-type: none">• Insert the mains plug.• Check the protection devices and fuses.• Turn the Power ON/OFF switch to "ON" position.• Allow the motor to cool down to room temperature (approx. 30mins) before resuming operation. Do not overfed the shredder.
Motor is running but cannot shred the papers	<ul style="list-style-type: none">• Waste bin is full.	<ul style="list-style-type: none">• Empty the waste bin.

Technical Specifications

Model	VS1208CD
Voltage	220-240 V 50Hz
Paper entry width	220 mm
Shred size	4 x 35 mm
Shred paper capacity	12 sheets (80 g/m ² , A4)
Shred speed	2.2m / min
Accept staples	Yes
Accept credit card	Yes
Accept CD	Yes
Waste bin Volume	25 Litre
Noise level	72 dB
Duty cycle	Approximate 3 minutes
Net weight	6.8kg
Dimension	360x244x464mm

We apologise for any inconvenience caused by any minor inconsistencies in these instructions, which may occur as a result of product improvements and development.



This appliance complies with the following EEC directives:
2006/95/EEC Low voltage directive
2004/108/EEC EMC directive

Disposal information



The symbol on the product or its packaging indicates that this product may not be treated as household waste. Instead it should be handed over to the applicable collection point for the recycling of electrical and electronic equipment. By ensuring this product is disposed of correctly, you will help prevent potential negative consequences for the environment and human health, which could otherwise be caused by inappropriate waste handling of this product. For more detailed information about recycling this product, please contact your local council office, your household waste disposal service or the shop where the product was purchased.

Guarantee



PRODUCT GUARANTEE

This product is guaranteed against manufacturing defects for a period of



Year

This product is guaranteed for twelve months from the date of original purchase.

Any defect that arises due to faulty materials or workmanship will either be replaced, refunded or repaired free of charge where possible during this period by the dealer from whom you purchased the unit.

The guarantee is subject to the following provisions:

- The guarantee does not cover accidental damage, misuse, cabinet parts, knobs or consumable items.
- The product must be correctly installed and operated in accordance with the instructions contained in this manual.
- It must be used solely for domestic purpose.
- The guarantee will be rendered invalidated if the product is re-sold or has been damaged by inexpert repair.
- Specifications are subject to change without notice.
- The manufacturer disclaims any liability for the incidental or consequential damages.
- The guarantee is in addition to, and does not diminish your statutory or legal rights.

Guarantor: Argos Ltd
489 - 499 Avebury Boulevard
Central Milton Keynes
MK9 2NW