

# Tefal®

EN



## User Guide

[www.tefal.com](http://www.tefal.com)

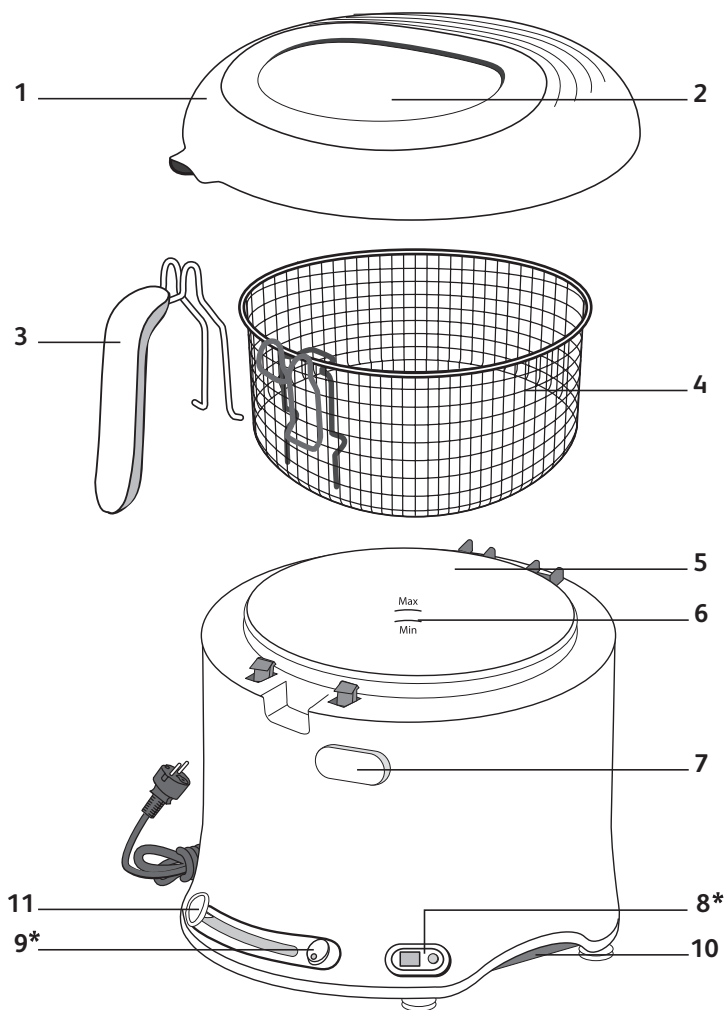

\* Depending on model.

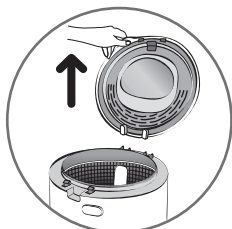

fig 1

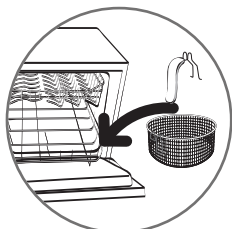

fig 2



fig 3



fig 4

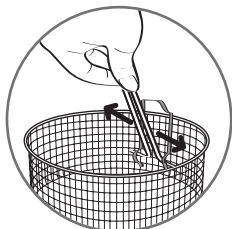

fig 5



fig 6

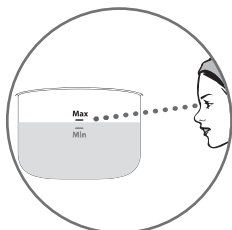

fig 7

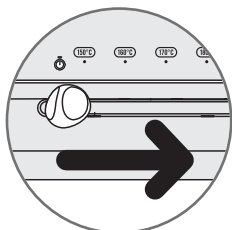

fig 8

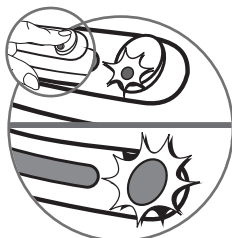

fig 9



fig 10

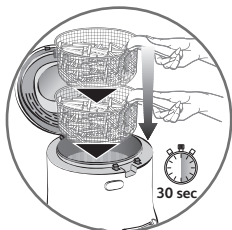

fig 11

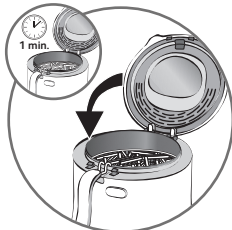

fig 12



fig 12a



fig 13



fig 14



fig 15

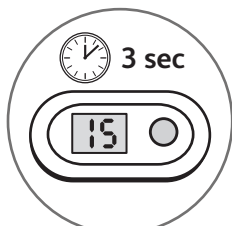

fig 16

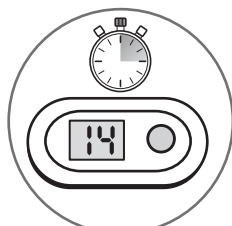

fig 17

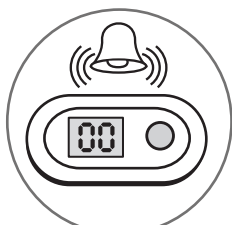

fig 18

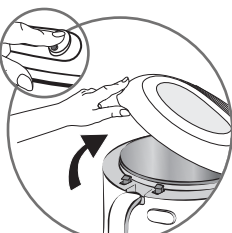

fig 19

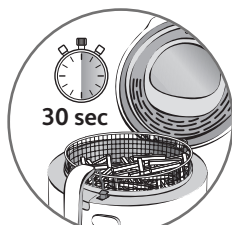

fig 20

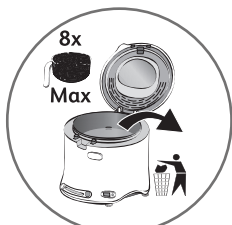

fig 21

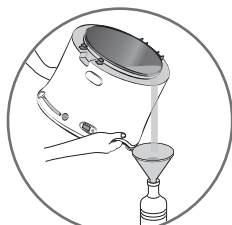

fig 22

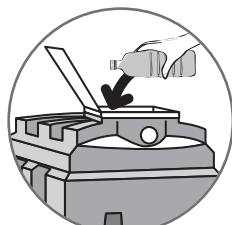
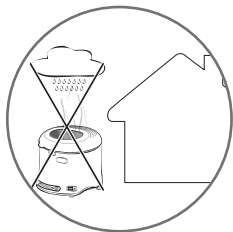

fig 22a



**Environment protection first!**

- ① Your appliance contains valuable materials which can be recovered or
- ➡ Leave it at a local civic waste collection point.

**HELPLINE:**

If you have any product problems or queries, please contact our Customer Relations Team first for expert help and advice:

0845 602 1454 – UK

(01) 677 4003 – ROI

# Safety instructions

## General instructions

- Read and follow the instructions for use. Keep them safe.
- This appliance is not intended to be operated using an external timer or separate remote control system.
- For your safety, this appliance complies with the safety regulations and directives in effect at the time of manufacture (Low-voltage Directive, Electromagnetic Compatibility, Food Contact Materials Regulations, Environment...).
- Check that the power supply voltage corresponds to that shown on the appliance (alternating current).
- Given the diverse standards in effect, if the appliance is used in a country other than that in which it is purchased, have it checked by a Tefal Approved Service Centre.
- This appliance is designed for indoor domestic household use only.
- In case of professional use, inappropriate use or failure to comply with the instructions, the manufacturer accepts no responsibility and the guarantee does not apply.
- Remove all packaging materials and any promotional labels or stickers from your deep fryer before use.
- Do not use the appliance if the appliance or the cord is damaged, if the appliance has fallen or shows visible damage or does not work properly. In the event of the above, the appliance must be sent to a Tefal Approved Service Centre. Do not take the appliance apart yourself.
- For your own safety, use only accessories and spare parts which are suitable for your appliance.

## Connecting to the power supply

- Always plug the appliance into a power socket outlet with an earth connection.
- Do not use an extension lead. If you accept liability for doing so, only use an extension lead which is in good condition, has a plug with an earth connection and is suited to the power of the appliance.
- If the power supply cord is damaged, it must be replaced by the manufacturer or a Tefal Approved Service Centre in order to avoid any danger.
- Do not leave the cord hanging. The power cord must never be in close proximity to or in contact with the hot parts of your appliance, close to a source of heat or rest on sharp edges.
- Do not unplug the appliance by pulling on the cord.
- Always unplug the appliance: immediately after use, when moving it, prior to any cleaning or maintenance.

## Using

- This appliance is not designed to be used by people (including children) with a physical, sensory or mental impairment, or people without knowledge or experience, unless they are supervised or given prior instructions concerning the use of the appliance by someone responsible for their safety.
- Children must be supervised to ensure that they do not play with the appliance.
- Use a flat, stable, heat-resistant surface, away from any water splashes.
- Never leave the appliance unattended when in use.
- This electrical equipment operates at high temperatures which may cause burns. Do not touch the hot parts of the appliance (filter, window, metal walls (depending on model), other apparent metal parts...). Be careful of hot steam and never put your hands above the filtration zone.
- Do not switch on the appliance near to flammable materials (blinds, curtains...) or close to an external heat source (gas stove, hot plate etc.).
- In the event of fire, never try to extinguish the flames with water. Close the lid. Unplug the appliance.
- Smother the flames with a damp cloth.
- Do not move the appliance when it is full of liquids or hot food.
- Never immerse the appliance or the electrical control unit in water !
- Before throwing away your appliance, the timer battery must be removed by a Tefal Service Centre (depending on model).
- Do not store your deep fryer outside. Store it in a dry and well ventilated area.
- It is essential that you wait until the oil has cooled down before storing the fryer.

## Cooking

- Never plug in the deep fryer without oil or fat inside.
- The oil level must always be between the min and max markers.
- If you use solid vegetable fat, cut it into pieces and melt it over a slow heat (max 150°C) in a separate pan beforehand, then slowly pour it into the deep fryer bowl. Never put solid fat directly into the deep fryer bowl or fryer basket as this will lead to deterioration of the appliance.
- Do not mix different types of oil. Never add water to the oil or fat.
- Do not overfill the basket, never exceed the maximum capacity.
- Oils to use: For best results we recommend using a good quality blended vegetable oil. If using Sunflower oil ensure the oil is changed after every 5 uses.
- Oils which should NOT be used under any circumstances and may cause overflowing/smoking/risk of fire are: ground nut oil, soya oil, olive oil, lard or dripping.
- If you have a removable anti-odour filter, change it after every 10 - 15 uses (foam filter) or after 30 - 40 uses (cartridge with saturation indicator), or 80 uses (carbon filter).

- Some models are equipped with a permanent metallic filter, which does not need to be changed.
- No matter what the recipe, whether preparing fresh or frozen food, it must be perfectly dry. Dry the food thoroughly with paper kitchen towel or a clean tea towel before frying. This will prevent the oil from splattering and/or overflowing, will extend the life of the oil and give crispier results.
- For frozen food, place the food into the basket and then shake the basket over the sink to remove any excess ice crystals.

## Recommendations

- Limit the cooking temperature to 190°C, especially for potatoes.
- Use the basket for chips.
- Check the cooking progress: Do not eat burnt food.
- Clean your oil after every use to avoid burnt crumbs and change it after every 8 to 10 uses (after every 5 uses if using Sunflower oil). Do not pour used oil/fat into the sink.
- Leave it to cool and throw it away with household waste - according to the local community regulations.
- Store your fresh potatoes in a room above 8°C.
- For best results and fast cooking, we recommend that you limit the quantity of chips to 1/2 basket per frying.
- For larger quantities of food or potatoes the temperature of the oil drops very fast just after having lowered the basket. This lowers the oil temperature considerably and it is normal for the temperature to take a while to return to 190°C.
- Take great care when handling the food and use tongs.
- Gradually place the food in the hot oil, submerging it an inch at a time to prevent it from sinking straightaway and any oil overflowing.
- For best results fry chips cut from fresh potatoes twice: A first fry at 170°C and a second fry at 190°C.



## Description

1. Lid
2. Viewing window
3. Basket handle
4. Basket
5. Fryer bowl
6. Min. and Max. filling levels
7. Lid open button
8. Timer (depending on model)
9. On/Off switch with light (depending on model)
10. Carry handles
11. Adjustable thermostat

## Preparation

### Before first use

- Press the button to unlock the lid and the lid will open.
- Remove the lid, the basket and the basket handle from the fryer - **fig 1**.
- Wash the basket and the basket handle in the dishwasher - **fig 2**.
- Wash the bowl and the lid with a sponge, warm water and a little washing-up liquid.
- Carefully rinse and dry all items.
- Fit the handle to the basket, by squeezing the handle together and fitting it into the notches on the basket. Then release pressure on the handle and pull it back up so it clicks in place - **fig 5 and 6**.
- Place the basket inside the fryer.
- Replace the fryer lid.

**Never immerse this appliance or the lid in water - fig 3.**

**Never put the appliance body or the lid in the dishwasher - fig 4.**

**Your fryer should always be used indoors.**

**Never mix different types of oil or fat because this could cause the fryer to overflow.**

The oil/fat level should always be between the Min. and Max. levels shown inside the bowl. - **fig. 7**.

**Check this before each use and add the same type of oil/fat as required.**

- Fill the bowl with oil.
- Never fill the bowl above the maximum level shown on the bowl - **fig 7**.

	Oil	Solid vegetable fat
Max.	2.1 L	1910 g
Min.	1.9 L	1600 g

- Use an oil recommended for frying: blended vegetable oil or sunflower oil. If using sunflower oil ensure the oil is changed after every 5 uses. Oil which should not be used under any circumstances and may cause overflowing/smoking/risk of fire are: ground nut oil, soya oil, olive oil, lard or dripping.

## Filling the bowl

- If you use solid fat, chop it into pieces and then melt it in a separate pan before pouring it into the bowl (never melt solid fat in the basket or in the bowl).
- Never exceed 150°C to melt the fat that has solidified in the bowl. For the cooking temperature follow the instructions (see cooking charts **p.10**).
- **NEVER** use animal fat such as lard or dripping as this could cause overflowing, smoke or a fire hazard.

## Pre-heating

---

- After filling the bowl with the fat, close the lid and plug in your fryer without the basket
- Adjust the thermostat - **fig 8** depending on the food to be fried (see cooking charts **p. 11**).
- Press the On/Off switch. The indicator will light up - **fig 9**.
- When the temperature indicator switches off, press the lid unlock button to open the lid and allow the steam to escape.

### Place the fryer:

- on a secure surface
- out of the reach of children
- away from any sources of water splashes or heat.

**Never plug the fryer in when it is empty (without any oil or fat) - fig 10.**

---

## Loading the basket

Never exceed the maximum safety limit – fresh products 1200 g, frozen 900 g. To avoid overflowing and extend the life of the oil, dry the food carefully before cooking it.

- Dry the food to remove any excess water or ice.
- Fill the basket before placing it in the fryer.
- Do not overfill the basket.
- Reduce quantities for frozen food.
- Tip: Cut food to the same sized pieces so that it cooks evenly. Avoid pieces that are too thick.

## Cooking

### Lowering the basket

---

- After the temperature indicator light goes out, very gently lower the basket into the oil - **fig 11**. Lowering it too quickly could cause the fryer to overflow - Wait for one minute with the lid open - **fig 12** then close the lid - **fig 12a**.

- Set the cooking time (depending on model): for models with timer, press the button to adjust the time minute by minute. The selected time is displayed and the countdown begins - **fig 14 to fig 18**.
- You can stop the countdown, during the cooking by pressing the timer button for 3 seconds.
- During cooking, it is normal for the temperature light to switch on and off.

**Do not place your hand above the filter system - fig. 13, or over the viewing window. The steam and the glass will be hot. Do not touch the fryer walls which may also be hot.**

## At the end of cooking

**The timer (depending on model) signals the end of the cooking time, but does not stop the appliance.**

**For crispy fried food, open the lid as soon as you have finished cooking to prevent steam from softening the food.**







**The lid cannot be closed while the basket is hooked on the edge of the bowl.**

- The timer emits a sound (depending on model), indicating that the programmed cooking time has ended. To stop the timer alarm, press the button.
- Set the thermostat to the minimum position.
- Press the On/Off button.
- Press the lid unlock button to open and allow the steam to escape for around 30 seconds - **fig 19**. Open the lid.
- Raise the basket and hook it onto the edge of the bowl. Leave to drain for 30 seconds - **fig 20**.
- Close the lid when the fryer is not in use.
- To cook more food, add oil/fat as required, set the thermostat to the required temperature, press the On/Off switch and then wait until the temperature light comes on before placing the new food in the oil.

## Table of cooking times

- The cooking times are a guide only; they may vary depending on the size of the food and the amount of food and individual preferences. Thicker food may require turning halfway through frying to ensure even cooking on both sides.
- Cooking tips: For best results, use the traditional French method of frying homemade chips:
  - first frying at 170 °C
  - second frying at 190 °C
- When cooking battered food and doughnuts, remove the wire basket to prevent food sticking to it and use tongs to slowly lower the food into the hot oil.

**When cooking battered food and doughnuts, take great care when handling the food and use tongs. Gradually place the food into the hot oil, submerging it an inch at a time to prevent it from sinking immediately.**

Fresh food	Volume	Weight/ quantity	°C	
Chips		1200 g	170°C	9-10 min.
			190°C	6-7 min.
Chips		1000 g	190°C	13-14 min.
Chips		600 g	190°C	11-16 min.
Fried chicken (drumsticks)		8	180°C	14-16 min.
Breaded fish fillets		1-2	170°C	6-8 min.
Fried whole breaded mushrooms		8	150°C	5-7 min.
Vegetable fritters		10-12	180°C	6-8 min.
Battered calamari		500 g	180°C	5-6 min.
Apple fritters		4	180°C	5-6 min.
Frozen food	Volume	Weight/ quantity	°C	
Frozen chips		900 g	190°C	10-12 min.
Frozen chips		450 g	170°C	9-13 min.
Breaded onion rings		6-8	190°C	3-4 min.
Chicken nuggets		900 g	190°C	7-9 min.
Breaded fish fillets		8	190°C	5-7 min.

### SWITCHING OFF THE FRYER

When you have finished frying, press the ON/OFF switch.

Unplug the fryer.

Leave the fryer and the oil/fat inside to cool completely (approx 2 hours).

# Cleaning

## Filtering and Storing the oil

- You may store the oil in the fryer, or in a separate airtight container.
- If you use solid vegetable fat, we advise you to store it separately from the fryer.
- Crumbs that break away from foods tend to burn and alter the quality of the oil more rapidly. Over time, this increases the risk of catching fire. For this reason, filter the oil regularly.

**Leave the fryer with the oil in the bowl to cool completely before filtering the oil (2 hours).**

## Changing the oil

**We recommend changing the oil/fat after a maximum of 8 uses. - fig.21.** • Do not pour used oil/fat into the sink. Leave it to cool, and throw it away with household waste-according to the local community regulations - fig 22 and fig 22a.

## Cleaning the fryer

- Always unplug your fryer and leave it to cool completely before cleaning it (approx. 2 hours).
- Remove the lid and the basket.
- Put the basket and basket handle in the dishwasher or wash them with a sponge, warm water and a little washing-up liquid.
- Do not immerse the lid in water, instead wipe the lid with a sponge soaked in warm water and a little washing-up liquid. We recommend cleaning the viewing window after each use by wiping it with a sponge and fresh lemon juice. Allow the window to dry at room temperature or dry with a clean cotton cloth.
- Dry all items carefully before replacing them.
- Put the lid back on the fryer for storage.
- If you do not keep the oil in your fryer, you can store the basket and the basket handle inside the fryer.
- The lid is fitted with a permanent metallic filter, you don't need to change it.

**You cannot remove the metallic filter located in the lid when washing the lid.**

**Never immerse your appliance or the lid in water and never wash it under running water.**

**Never wash the appliance body in the dishwasher.**

**Do not use aggressive or abrasive cleaning products.**

**Do not store your deep fryer outside, store it in a dry and well-ventilated area.**

# Problems and solutions

Problems and possible causes	Solutions
<b>The deep fryer does not work.</b>	
The appliance is not plugged in.	Plug in the appliance.
<b>Unpleasant odours.</b>	
The oil/fat has deteriorated.	Replace the frying oil/fat (after 8 uses max.), or more frequently depending on the type of oil/fat used.
The oil/fat is unsuitable.	Use a good quality blended vegetable oil/fat. (see p.7).
<b>Steam escapes from around the lid.</b>	
The lid is not closed properly.	Check that the lid is properly closed and the hinge is clean.
Food is wet or contains too much water (frozen food).	Remove any ice and dry the food thoroughly. Lower the basket slowly (see p.8).
Different types of oil have been mixed.	Empty and clean the bowl. Refill the bowl with one type of oil.
<b>Vision through the viewing window is not clear.</b>	
Not cleaning the window often enough or using an inappropriate cleaning method.	To ensure good visibility, clean the viewing window by wiping it with a sponge and lemon juice. Allow the window to dry at room temperature or dry with a clean cotton cloth.

Problems and possible causes	Solutions
<b>The frying oil overflows.</b>	
The Max. marker for filling the bowl has been exceeded.	Check the level (Max.) and remove the excess of oil after the fryer is cool.
The frying basket has been overfilled with food.	Check that the basket is not too full.
Food is wet or contains too much water (i.e. frozen food).	Remove any ice and dry the food thoroughly before frying.
Wrong oil or different types of oil/fat have been mixed.	Empty and clean the bowl. Refill the bowl with one type of oil/fat.
Unsuitable oil/fat has been used.	Use a good quality blended vegetable oil/fat (see p. 7).
<b>Food does not become golden and remains soft.</b>	
Pieces are too thick and contain too much water.	Experiment by lengthening the cooking time or by cutting food smaller and thinner.
Too much food is being cooked at the same time and the cooking oil/fat is no longer at the right temperature.	Respect the recommended quantities of food (see table of cooking p.10).
The temperature of the frying oil/fat may not be high enough: the temperature is set incorrectly.	Set the thermostat selector to the recommended temperature.
<b>Chips stick together.</b>	
Potatoes have not been washed before immersed in hot oil/fat.	Cut the potatoes and wash them well to remove starch and then dry them thoroughly.
Too much food is being cooked at the same time.	Respect the recommended quantities of food (see table of cooking p.10).
<b>The timer no longer works (depending on model)</b>	
The battery is low.	Have it replaced by an approved Service Centre.





# INTERNATIONAL GUARANTEE : COUNTRY LIST

			
الجزائر <b>ALGERIA</b>	CIJA 9 rue Puvis de Chavannes Saint Euquene Oran	1 an 1 year	<b>(0)41 28 18 53</b>
<b>ARGENTINA</b>	GRUPE SEB ARGENTINA S.A. Billinghurst 1833 3° C1425DTK Capital Federal Buenos Aires	2 años 2 years	<b>0800-122-2732</b>
ՀԱՅԱՍՏԱՆ <b>ARMENIA</b>	ՓԲԸ "Գրուպա ՄԵԲ", 125171, Մոսկվա, Լենինգրադյան խճուղի, 16A, շին.3	2 տարի 2 years	<b>(010) 55-76-07</b>
<b>AUSTRALIA</b>	GRUPE SEB AUSTRALIA PO Box 7535, Silverwater NSW 2128	1 year	<b>02 97487944</b>
ÖSTERREICH <b>AUSTRIA</b>	SEB ÖSTERREICH HmbH Campus 21 - Businesspark Wien Süd Liebermannstr. A02 702 2345 Brunn am Gebirge	2 Jahre 2 years	<b>01 866 70 299 00</b>
<b>BELGIQUE BELGIE</b> <b>BELGIUM</b>	GRUPE SEB BELGIUM SA NV 25 avenue de l'Espérance - ZI 6220 Fleurus	2 ans 2 years	<b>070 23 31 59</b>
<b>БЕЛАРУСЬ</b> <b>BELARUS</b>	ЗАО «Группа СЕБ-Восток», 125171, Москва, Ленинградское шоссе, д. 16А, стр. 3	2 года 2 years	<b>017 2239290</b>
<b>BOSNA I</b> <b>HERCEGOVINA</b>	SEB Développement Predstavništvo u BiH Vrazova 8/II 71000 Sarajevo	2 godine 2 years	<b>Info-linija za potrošače 033 551 220</b>
<b>BRASIL</b> <b>BRAZIL</b>	SEB DO BRASIL PRODUTOS DOMÉSTICOS LTDA Avenida Arno, 146 Mooca 03108-900 São Paulo SP	1 ano 1 year	<b>0800-119933</b>
<b>БЪЛГАРИЯ</b> <b>BULGARIA</b>	ГРУП СЕБ БЪЛГАРИЯ ЕООД Ул. Борово 52 Г, ет. 1, офис 1, 1680 София	2 години 2 years	<b>0700 10 330</b>
<b>CANADA</b>	GRUPE SEB CANADA 345 Passmore Avenue Toronto, ON M1V 3N8	1 an 1 year	<b>800-418-3325</b>
<b>CHILE</b>	GRUPE SEB CHILE Comercial Ltda Av. Providencia, 2331, piso 5, oficina 501 Santiago	2 años 2 years	<b>12300 209207</b>

<b>COLOMBIA</b>	GRUPE SEB COLOMBIA Apartado Aereo 172, Kilometro 1 Via Zipaquira Cajica Cundinamarca	2 años 2 years	<b>18000919288</b>
<b>HRVATSKA CROATIA</b>	SEB Development S.A.S. Vodnjanska 26 10000 Zagreb	2 godine 2 years	<b>01 30 15 294</b>
<b>ČESKÁ REPUBLIK CZECH REPUBLIC</b>	GRUPE SEB ČR spol. s r .o. Jankovcova 1569/2c 170 00 Praha 7	2 roky 2 years	<b>731 010 111</b>
<b>DANMARK DENMARK</b>	GRUPE SEB NORDIC AS Tempovej 27 2750 Ballerup	2 år 2 years	<b>44 663 155</b>
<b>DEUTSCHLAND GERMANY</b>	GRUPE SEB DEUTSCHLAND GmbH / KRUPS GmbH Herrnrainweg 5 63067 Offenbach	2 Jahre 2 years	<b>0212 387 400</b>
<b>EESTI ESTONIA</b>	GRUPE SEB POLSKA Sp. z o.o. ul. Bukowińska 22b 02-703 Warszawa	2 aastat 2 years	<b>5 800 3777</b>
<b>SUOMI FINLAND</b>	Groupe SEB Finland Kutojantie 7 02630 Espoo	2 Vuotta 2 years	<b>09 622 94 20</b>
<b>FRANCE Incluant uniquement Guadeloupe, Martinique, Réunion, Saint-Martin</b>	GRUPE SEB FRANCE Service Consommateur Tefal BP 15 69131 ECULLY CEDEX	1 an 1 year	<b>09 74 50 47 74</b>
<b>ΕΛΛΑΔΑ GREECE</b>	SEB GROUPE ΕΛΛΑΔΟΣ Α.Ε. Οδός Καβαλιεράτου 7 Τ.Κ. 145 64 Ν. Κηφισιά	2 χρόνια 2 years	<b>2106371251</b>
<b>香港 HONG KONG</b>	SEB ASIA Ltd. Room 903, 9/F, South Block, Skyway House 3 Sham Mong Road, Tai Kok Tsui, Kowloon Hong-Kong	1 year	<b>852 8130 8998</b>
<b>MAGYARORSZÁG HUNGARY</b>	GRUPE SEB CENTRAL-EUROPE Kft. Táviró köz 4 2040 Budaörs	2 év 2 years	<b>06 1 801 8434</b>
<b>INDONESIA</b>	GRUPE SEB INDONESIA (Representative office) Sudirman Plaza, Plaza Marein 8th Floor JL Jendral Sudirman Kav 76-78, Jakarta 12910, Indonesia	1 year	<b>+62 21 5793 6881</b>
<b>ITALIA ITALY</b>	GRUPE SEB ITALIA S.p.A. Via Montefeltro, 4 20156 Milano	2 anni 2 years	<b>199207354</b>
<b>JAPAN</b>	GRUPE SEB JAPAN Co. Ltd. 1F Takanawa Muse Building, 3-14-13, Higashi Gotanda, Shinagawa-Ku, Tokyo 141-0022	1 year	<b>0570-077772</b>

<b>ҚАЗАҚСТАН KAZAKHSTAN</b>	ЖАҚ «Группа СЕБ- Восток» 125171, Мәскеу, Ленинградское шоссесі, 16А, 3 үйі	2 жыл 2 years	<b>727 378 39 39</b>
<b>한국어 KOREA</b>	(유)그룹 세브 코리아 서울시 종로구 서린동 88 서린빌딩 3층 110-790	1 year	<b>1588-1588</b>
<b>LATVIJA LATVIA</b>	GROUPE SEB POLSKA Sp. z o.o. ul. Bukowińska 22b 02-703 Warszawa	2 gadi 2 years	<b>6 716 2007</b>
<b>LIETUVA LITHUANIA</b>	GROUPE SEB POLSKA Sp. z o.o. ul. Bukowińska 22b 02-703 Warszawa	2 metai 2 years	<b>6 470 8888</b>
<b>LUXEMBOURG</b>	GROUPE SEB BELGIUM SA NV 25 avenue de l'Espérance - ZI 6220 Fleurus	2 ans 2 years	<b>0032 70 23 31 59</b>
<b>MACEDONIA</b>	Groupe SEB Bulgaria EOOD Office 1, floor 1, 52G Borovo St., 1680 Sofia - Bulgaria ГРУП СЕБ БЪЛГАРИЯ ДООЕЛ Ул. Борово 52 Г, сп. 1, офис 1, 1680 София, България	2 години 2 years	<b>(0)2 20 50 022</b>
<b>MALAYSIA</b>	GROUPE SEB MALAYSIA SDN. BHD Lot No.C/3A/001 & 002, Block C, Kelana Square No.17, Jalan SS7/26, 47301 Kelana Jaya Petaling Jaya, Selangor	1 year	<b>65 6550 8900</b>
<b>MEXICO</b>	Groupe.S.E.B. México, S.A. DE C.V. Goldsmith 38 Desp. 401, Col. Polanco Delegación Miguel Hidalgo 11 560 México D.F.	1 año 1 year	<b>(01800) 112 8325</b>
<b>MOLDOVA</b>	ТОВ «Груп СЕБ Україна» 02121, Харківське шосе, 201-203, 3 поверх, Київ, Україна	2 ani 2 years	<b>(22) 929249</b>
<b>NEDERLAND The Netherlands</b>	GROUPE SEB NEDERLAND BV Generatorstraat 6 3903 LJ Veenendaal	2 jaar 2 years	<b>0318 58 24 24</b>
<b>NEW ZEALAND</b>	GROUPE SEB NEW ZEALAND Unit E, Building 3, 195 Main Highway, Ellerslie, Auckland	1 year	<b>0800 700 711</b>
<b>NORGE NORWAY</b>	GROUPE SEB NORDIC AS Tempovej 27 2750 Ballerup DANMARK	2 år 2 years	<b>815 09 567</b>
<b>PERU</b>	Groupe SEB Perú Av. Camino Real N° 111 of. 805 B San Isidro - Lima - Perú	1 año 1 year	<b>441 4455</b>

<b>POLSKA POLAND</b>	GRUPE SEB POLSKA Sp. z o.o. ul. Bukowińska 22b 02-703 Warszawa	2 lata 2 years	<b>0801 300 421</b> koszt jak za połączenie lokalne
<b>PORTUGAL</b>	GRUPE SEB IBÉRICA SA Urb. da Matinha Rua Projectada à Rua 3 Bloco1 - 3° B/D 1950 - 327 Lisboa	2 anos 2 years	<b>808 284 735</b>
<b>REPUBLIC OF IRELAND</b>	GRUPE SEB IRELAND Unit B3 Aerodrome Business Park, College Road, Rathcoole, Co. Dublin	1 year	<b>01 677 4003</b>
<b>ROMÂNIA ROMANIA</b>	GRUPE SEB ROMÂNIA Str. Daniel Constantin nr. 8 010632 București	2 ani 2 years	<b>0 21 316 87 84</b>
<b>РОССИЯ RUSSIA</b>	ЗАО «Группа СЕБ-Восток», 125171, Москва, Ленинградское шоссе, д. 16А, стр. 3	2 года 2 years	<b>495 213 32 30</b>
<b>SRBIJA SERBIA</b>	SEB Développement Đorđa Stanojevića 11b 11070 Novi Beograd	2 godine 2 years	<b>060 0 732 000</b>
<b>SINGAPORE</b>	GRUPE SEB SINGAPORE Pty Ltd. 59 Jalan Pemimpin, #04-01/02 L&Y Building Singapore 577218	1 year	<b>65 6550 8900</b>
<b>SLOVENSKO SLOVAKIA</b>	GRUPE SEB Slovensko, spol. s r.o. Rybničná 40 831 06 Bratislava	2 roky 2 years	<b>233 595 224</b>
<b>SLOVENIJA SLOVENIA</b>	SEB d.o.o Gregorčičeva ulica 6 2000 MARIBOR	2 leti 2 years	<b>02 234 94 90</b>
<b>ESPAÑA SPAIN</b>	GRUPE SEB IBÉRICA S.A. C/ Almogàvers, 119-123, Complejo Ecourban 08018 Barcelona	2 años 2 years	<b>902 31 24 00</b>
<b>SVERIGE SWEDEN</b>	TEFAL SVERIGE SUBSIDIARY OF GROUP SEB NORDIC Truckvägen 14 A, 194 52 Upplands Väsby	2 år 2 years	<b>08 594 213 30</b>
<b>SUISSE CHWEIZ SWITZERLAND</b>	GRUPE SEB SCHWEIZ GmbH Thurgauerstrasse 105 8152 Glattbrugg	2 ans 2 Jahre 2 years	<b>044 837 18 40</b>
<b>TAIWAN</b>	SEB ASIA Ltd. Taipei International Building, Suite B2, 6F-1, No. 216, Tun Hwa South Road, Sec. 2 Da-an District Taipei 106, R.O.C.	1 year	<b>886-2-27333716</b>
<b>THAILAND</b>	GRUPE SEB THAILAND 2034/66 Italthai Tower, 14th Floor, n° 14-02, New Phetchburi Road, Bangkapi, Huaykwang, Bangkok, 10320	2 years	<b>662 351 8911</b>

<b>TÜRKIYE TURKEY</b>	GROUPE SEB ISTANBUL AS Beybi Giz Plaza Dereboyu Cad. Meydan Sok. No: 28 K.12 Maslak	2 YIL 2 years	<b>216 444 40 50</b>
<b>U.S.A.</b>	GROUPE SEB USA 2121 Eden Road Millville, NJ 08332	1 year	<b>800-395-8325</b>
<b>Україна UKRAINE</b>	ТОВ «Груп СЕБ Україна» 02121, Харківське шосе, 201-203, 3 поверх, Київ, Україна	2 роки 2 years	<b>044 492 06 59</b>
<b>UNITED KINGDOM</b>	GROUPE SEB UK LTD Riverside House Riverside Walk Windsor Berkshire,SL4 1NA	1 year	<b>0845 602 1454</b>
<b>VENEZUELA</b>	GROUPE SEB VENEZUELA Av Eugenio Mendoza, Centro Letonia, Torre ING Bank, Piso 15, Ofc 155 Urb. La Castellana, Caracas	2 años 2 years	<b>0800-7268724</b>
<b>VIETNAM</b>	GROUPE SEB VIETNAM (Representative office) 127-129 Nguyen Hue Street District 1, Ho Chi Minh City, Vietnam	1 year	<b>+84-8 3821 6395</b>

 : [www.tefal.com](http://www.tefal.com)

