

### STEP 3

Affix the Support Leg (C) as shown in the diagram to the Sofabed (A).

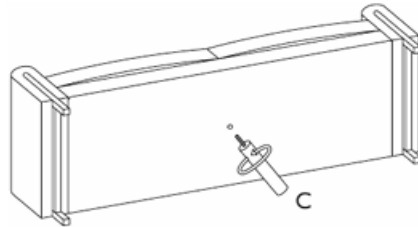

### STEP 4

#### CONVERTING TO SOFA / LOUNGER / BED

Standing at the Back/Side of the unit (from bed position), lift backrest to the desired position and secure in place by releasing to the sound of a click.

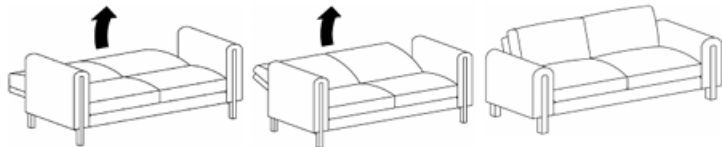

Please Note:

There are "hidden" legs within the back section of the sofabed, which are to be used when in it is in bed position.

Ensure to pull these out before converting from sofa to bed position.

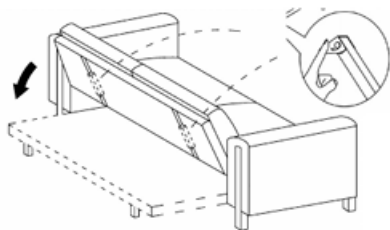

FABRIC CONTENT  
MAIN FABRIC 100% POLYESTER  
OTHER FABRIC (VISIBLE)  
NON-WOVEN FABRIC 100% POLYESTER

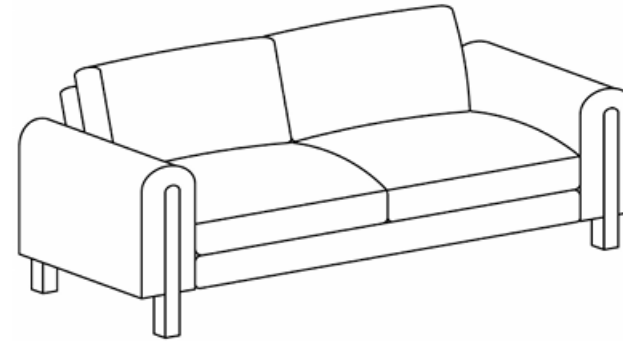

## KY540 SOFA BED

Thank you for your purchase. The following care instructions will allow you to make the most of your sofa bed; helping to prolong the look and life of it by preventing wear and damage.

### IMPORTANT INFORMATION

**PLEASE ENSURE YOU READ THIS LEAFLET BEFORE USING YOUR SOFA BED. DO NOT DISCARD OF ANY PACKAGING UNTIL YOU HAVE CHECKED THE PRODUCT THOROUGHLY.**

### CARING FOR YOUR SOFA BED

- Pre-brush fabric with a soft brush and then gently vacuum.
- In the event of a spill or stain, use specialist upholstery cleaner or cleaning services.
- Use a microfibre cloth to remove dust from wooden surfaces.







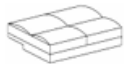

### SUNLIGHT AND HEAT DAMAGE

- Avoid contact with direct sunlight. If needed, move items or change their position to avoid the same area being exposed to repeated sunlight/heat.
- Do not place your sofa bed close to fire places and/or radiators.
- Hot objects such as mugs/plates can permanently mark the fabric and wood, avoid placing these on the sofa bed.

## SAFETY WARNING

- Do not allow children or pets to climb or jump on the sofa bed.
- Avoid contact with sharp objects such as buckles, toys and jewellery as these can easily snag, tear and/or pull the fabric.
- Avoid the risk of entrapment by using the sofa bed as intended; sitting facing forward on the seat.
- Do not allow children to operate the sofa bed mechanism.

## PARTS LIST

IMAGE	NAME	PART	QTY
	Sofabed	A	1
	Armrest	B	2
	Support Leg	C	1
	Bolts	D	4
	Bolts	E	4
	Washer	F	8
	Nut	G	4
	Spanner	H	1
	Allen key	I	1

## ASSEMBLY INSTRUCTIONS

Unpack your sofa bed and check that all the parts on the Parts List are present. If any are missing, please contact the retailer from whom you purchased the product.

We would advise having two people to assemble this product.

### STEP 1

Ensure Bolts (E) are inserted on the top two holes on the Armrest (B), Affix the Armrest (B) from inside velcro compartment to Sofabed (A) as shown in the diagram using the Washers (F), Nuts (G) and Spanner (H).

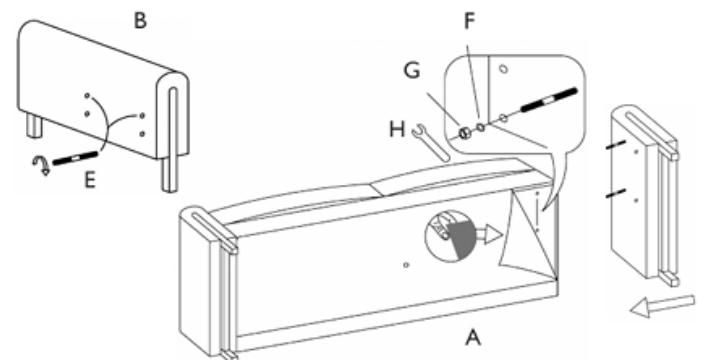

### STEP 2

Affix the Armrest (B) as shown in the diagram to the Sofabed (A) using the Bolts (D), Washers (F) and Allen Key (I).

