



INSTRUCTION MANUAL



McGregor 4 Tier Mini Greenhouse

Model: 8841443

Important - Please read these instructions fully before starting assembly









These instructions contain important information that will help you get the best from your product, ensuring it is assembled correctly and safely. If you need help or have damaged or missing parts, call the Customer Helpline on **0345 640 0800**

**AFTER SALES SUPPORT
0345 640 0800**

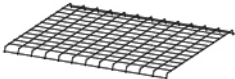
Contents

Package contents/parts	02
Assembly	03
Safety	05
Technical data	06

Package contents/parts

A	Short Tube	 36cm	12x
B	Long Tube	 88cm	12x
C	Side Frame		8x
D	Shelf		4x
E	Roof Tube		2x
F	Roof Tube		2x
G	Top cross bar		1x
H	Cover		1x
I	ROPE		1x

Assembly Instructions

Please read before assembly and keep for future reference.

INSTRUCTIONS

- Starting with the cover unzipped .
- Assemble as shown in figure .
- Secure to frame with ties attached to inside of cover .

IMPORTANT

- Please check the pack contains before assembly. And remember the codes/letters of different tubes .
- A full list of parts is given at previous page .
- The item should be sited in a sheltered spot away from prevailing winds .
- To avoid damage to the cover please unfold it carefully and allow it to rest until completely flexible .
- Use the rope (I) to secure the shelves to the frame , for extra stability .
- If cover fits tight , please make sure tubes are fully into connectors. If necessary , support connectors by wall or ground , then apply some gentle pressure on tubes .
- You may utilize the cloth loop at the back of the greenhouse cover to fix its position. For example, rope through the loop and fix the rope to a wall or ground .

If the two holes on Tube F and Tube E do not align when they are fit together , please loosen the tubes slightly to align the two holes before inserting metal peg G .

1

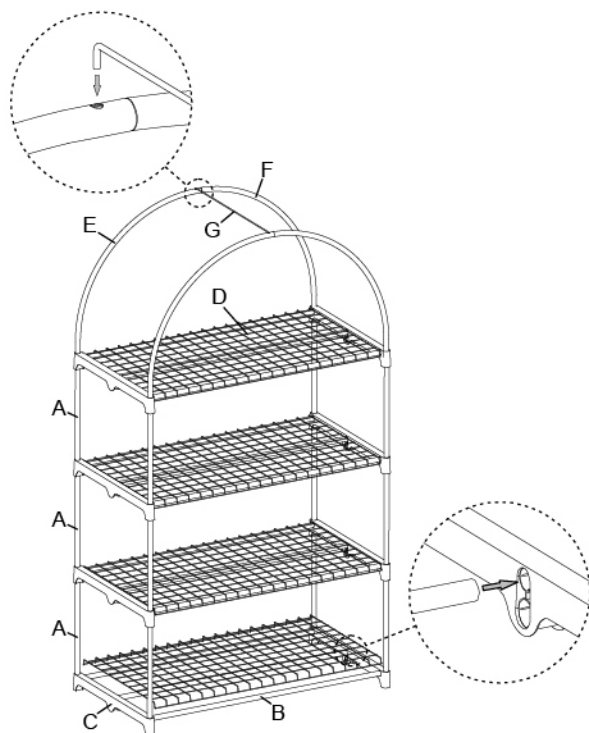

2

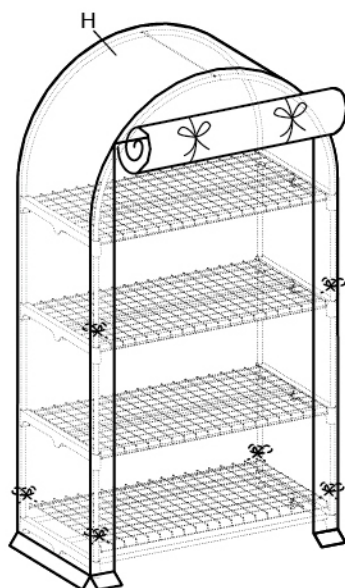

Safety



Risk of injury!

Improper use or assembly of the greenhouse may result in injury.

- Make sure that the greenhouse is only assembled by competent persons.
- Do not assemble the greenhouse in strong wind or under bad weather.
- Do not leave children unattended nor allow them to play with the greenhouse. The greenhouse is not a climbing frame or toy.
- Make sure children do not play with the plastic wrapper. They may get caught in it when playing and suffocate.
- Only set up the greenhouse on a flat, level and stable surface. Otherwise, there is a risk of it falling over and injury.
- Be careful of where you place your fingers and hands when assembling the greenhouse. You may accidentally pinch your fingers and/or hands.
- Only use the greenhouse when it has been appropriately assembled.
- Evenly distribute the load on the greenhouse so that it cannot overturn.
- Always remove all items from the greenhouse before moving it.
- Do not stand, lean or jump on the greenhouse. Do not use the greenhouse as a climbing aid or steps.
- Do not rely on the greenhouse as your shelter from extreme weather.
- Never store the greenhouse in such a way that there is a risk of it falling over, or falling from an elevated position.



Risk of damage!

Improper handling of the greenhouse may result in damage to the greenhouse.

- Do not position the greenhouse in an area exposed to excessive wind.
- Make sure the greenhouse is stable before use.
- In winter, regularly remove the accumulated snow on the roofs of the greenhouse to avoid dangerous snow-loading.
- Do not exceed the load-bearing capacity per shelf of 12 kg.
- Never place the greenhouse on or near heat sources such as ovens or heaters.
- Do not light a fire inside the greenhouse.

- Do not use the greenhouse if it is cracked, deformed or broken.
- Avoid spots where the greenhouse may stand in water for long periods.
- Regularly check that all connections are secure.
- Do not exert any pressure on the greenhouse. The greenhouse may become imbalanced and tip over.
- Do not combine two or more greenhouses together and use as one unit.

Cleaning

Improper handling of the greenhouse may result in damage to the greenhouse.

- Do not use any aggressive cleaners, brushes with metal or nylon bristles, or sharp or metallic cleaning utensils such as knives, hard scrapers and the like. They could damage the surfaces.
1. Remove all items from the greenhouse.
 2. Wipe the greenhouse clean with a damp cloth. Use a mild detergent if necessary for stubborn stain.
 3. Let all parts dry completely.

Storage

All parts must be completely dry before being stored.

- The cover can be removed and the main frame should be disassembled for storage.
- Always store the greenhouse in a dry area and keep it out of direct sunlight.
- Store the greenhouse so that it is not accessible to children.

Technical data

Model:	8841443
Weight:	Approx. 4.8 kg
Dimension (W×D×H):	Approx. W89 × D50 × H162 cm
Load-bearing capacity per shelf:	12 kg
Product code:	8841443

Customer Helpline **0345 640 0800**