





1. Radiating cooking zone Ø 145
2. Radiating cooking zone Ø 180
3. Radiating cooking zone Ø 145
4. Radiating cooking zone Ø 180
5. Rear right cooking zone control knob 
6. Rear left cooking zone control knob 
7. Front left cooking zone control knob 
8. Front right cooking zone control knob 

- To use the hob, turn the knob(s) clockwise and set it/them to the required power.
- To turn the hob off, turn the knob(s) back to position "0".
- The hob is fitted with residual heat indicators. These light up when the cooking zones reach temperatures that could cause burns. These indicators remain alight after the cooking zones are switched off, and turn off only when the zones are no longer hot enough to be dangerous.

Important:

To avoid permanently damaging the glass-ceramic top, do not use:



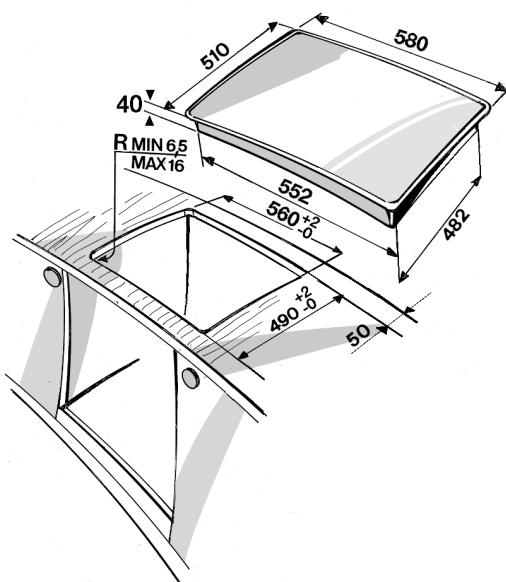

- Pots with bottoms that are not perfectly flat.
- Metal pots with enamelled bottom.

DIMENSIONS OF THE COOKTOP AND WORKTOP (mm)



Make sure that the voltage indicated on the rating plate is the same as the mains voltage. Technical data is given on the rating plate on the edge of the hob and also below:

ELECTRICAL CONNECTION

Supply voltage	Cables (number and size)
230V ~ + 	3 x 2,5 mm ²
230V 3 ~ + 	4 x 1,5 mm ²
400V 3N ~ + 	5 x 1,5 mm ²
400V 2N ~ + 	4 x 1,5 mm ²

Type PLEVS 230 V~/400 V 3 N~ 50 Hz 5.8 kW

PROTECTING THE ENVIRONMENT

Disposal of packaging materials

- The packing material can all be fully recycled, as confirmed by the recycling symbol .
- The various parts of the packing must not be sent for waste, but recycled in conformity with the regulations imposed by local authorities.

Disposal of used household appliances

- This appliance is marked according to the European directive 2012/19/EC on Waste Electrical and Electronic Equipment (WEEE). By ensuring this product is disposed of correctly, you will help prevent potential negative consequences for the environment and human health, which could otherwise be caused by inappropriate waste handling of this product. The symbol  on the product, or on the documents accompanying the product, indicates that this appliance may not be treated as household waste. Instead it shall be handed over to the applicable collection point for the recycling of electrical and electronic equipment. Disposal must be carried out in accordance with local environmental regulations for waste disposal. For more detailed information about treatment, recovery and recycling of this product, please contact your local city office, your household waste disposal service or the shop where you purchased the product.

Energy saving

- Use pots and pans whose bottom diameter is equal to that of the cooker plates, or slightly larger.
- Only use flat-bottomed pots and pans.
- If possible, keep the pot covered when cooking.
- Cook vegetables, potatoes, etc. with little water in order to cut down cooking time.
- A pressure cooker allows you to save even more energy and time.

CAUTION

- **This appliance is not intended for use by persons (including children) with reduced physical, sensory or mental capabilities or lack of experience and knowledge unless they have been given initial supervision or instruction concerning use of the appliance by a person responsible for their safety. Children should be supervised to ensure that they do not play with the appliance.**
- The appliance is not intended to be operated by means of an external timer or separate remote-control system.
- Should the hob become cracked or broken, do not use it and call the After Sales Service immediately.
- If the hob incorporates halogen cooking elements, do not stare at them.
- The hob is designed for use as a domestic food cooker only. No other type of use is allowed. The Manufacturer declines all responsibility for inappropriate use or incorrect setting of the controls.
- Do not expose the hob to atmospheric agents.
- Any repairs or adjustments must be carried out exclusively by an authorised technician.
- Avoid touching the hob with wet hands or using it when barefoot.
- **Do not allow children to touch:**
 - the hob in general, to avoid burns. During and immediately after use the hob reaches extremely high temperatures;
 - packing materials (bags, polystyrene, metal parts, etc.);
 - the hob to be scrapped.
- Make sure that the electrical wires of other electrical appliances near the hob do not come into contact with hot parts of the hob itself.
- Always keep a watch on pans when cooking with oil and grease. The oil and grease might overheat and catch fire!
- Do not use the hob as a support or worktop.
- Do not leave the hot plates/cookers turned on when they are empty.
- Do not rest plastic, aluminium foil, cloths, paper etc. on the hot plates/cookers.
- The hob is fitted with hot plates/cookers of different sizes. Use pans whose bottom diameter is equal to that of the hot plates/cookers, or slightly larger.

BEFORE USING THE COOKING HOB

Before use, remove:

- adhesives stuck on the hob;
- cardboard guards and protective plastic film;
- check whether the hob has been damaged during transport. If in doubt, contact the After Sales Service.

ACCESSORY

Child guard AMH 122 This accessory can be obtained from the After Sales Service under code number 4819 310 18436 or from dealer under reference number 017124.

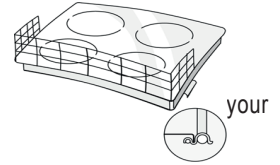

Care and maintenance

Important: never clean the appliance with high pressure water or steam cleaning equipment.

- Clean the hob, when it is cool, after each use. This will prevent the build-up of dirt and make cleaning easier.
- Use a clean cloth, absorbent kitchen wipes and washing up liquid or a specific glass ceramic cleaner.
- Remove baked-on dirt with the special scraper tool (if provided) and specific cleaning products.
- Any food spills should be cleaned off before they dry.
- Do not use abrasive products, chlorine-based cleaners, oven-cleaner spray or pan scourers.
- The hob should be treated periodically with specific products available from the shops, following the manufacturer's instructions.

Telescopic knobs (depending on model)

- The knobs can be lifted approx. 1 cm for cleaning.
- After cleaning, restore the knob to its original position.

TROUBLESHOOTING GUIDE

The hob does not work:

- Make sure that the power supply is on.
- Turn the hob off and on again, to make sure that the problem has been solved.
- Make sure that the knob is not turned to "0". Turn the multi-pole switch to "Off" for a few minutes and then turn it back to "On".

The hob will not switch off:

- disconnect the hob immediately from the power supply.

AFTER SALES SERVICE

Before you call the After Sales Service

- Make sure that you cannot solve the problem yourself following the points described in chapter "Troubleshooting Guide".

If after the above checks the fault still occurs, get in touch with the nearest After Sales Service.

Please give:

- a short description of the fault;
- the exact type and model of hob;
- service number (i.e., the number that follows the word SERVICE on the rating plate under the hob itself). The service number is also indicated on the guarantee booklet;
- your full address;
- your telephone number.

If any repairs are required, please contact an authorised **After Sales Service** (to guarantee that original spare parts will be used and repairs carried out correctly).

Failure to comply with these instructions may compromise the safety and quality of the product.

INSTALLATION

Recommendations

Important: Disconnect the hob from the mains before carrying out any installation work or servicing.

- All electrical connections must be made before connecting the appliance to the power supply.
- Installation must be carried out by a qualified technician in accordance with the manufacturer's instructions and in compliance with local regulations.
- Unpack the hob and make sure that the appliance has not been damaged during transport. If you are not sure contact the dealer or the nearest service centre.

Preparing the housing unit

- Cut the worktop to fit before installing the appliance. Carefully remove any shavings or sawdust that could prevent the appliance from running properly.

Attention: to install the hob on other surfaces than wood (marble, plastic, ceramic, marble, stone, etc.) remember to ask After Sales Service for the fixing plates (fig. 2) Code 4819 404 78697.

- The hob must be fitted in a worktop with a minimum thickness of 20 mm and a maximum of 50 mm.
- Insert a separator panel at a minimum distance of 90 mm from the bottom of the hob, so that it cannot be accessed by the user.
- If there is an oven under the hob, make sure that it is manufactured by us and equipped with a cooling system.
- There must be nothing between the hob and the oven (e.g. cables, insulating material, etc.).
- An adjacent column unit must be installed at least 100 mm from the edge of the hob.
- Cut an opening in the worktop of the given dimensions.
- We recommend you seal the internal edges of the worktop with wood glue or silicone.
- If not already in place, apply the supplied seal to the hob, after cleaning the adhesive surface thoroughly.

Glass-ceramic hob

Important: remove any protective film before installing the hob.

Make sure that the opening in the worktop for the hob is cut according to the dimensions given in the drawing, paying attention to the tolerance range.

The hob should not be forced into the worktop. Forcing the glass-ceramic top may cause it to crack (even at a later date)!

- If the worktop is made of wood, use the spring clips and screws provided.
 1. Secure the spring clips (A) (fig. 1) with the screws provided (B) (fig. 1) as shown, paying attention to the specified distances.
 2. Fit the hob into the worktop.
- If the worktop is made of marble, plastic, ceramic, stone, etc., the hob must be secured with special brackets (C) (fig. 2).
 1. Fit the hob into the worktop (fig. 1).
 2. Place the 4 brackets (C) in position in accordance with the thickness of the worktop as shown in fig. 2.
 3. Fasten the 4 screws (D) in the positions (E) (fig. 2).

Electrical connection

- Regulations require that the appliance be earthed.
- Connection to the mains must be carried out by a qualified technician in accordance with the manufacturer's instructions and in compliance with local regulations.
- The installer is responsible for connecting appliances correctly to the mains and for observing the safety regulations.
- The oven power cable must be long enough to connect the built-in appliance to the mains.
- Observance of safety directives requires that a multipole switch with a minimum contact gap of 3 mm be used for the installation.
- Do not use multiple plug adapters or extension leads.
- After the oven has been installed, the electrical components must be inaccessible.

Connecting the oven to the power supply

Note: the yellow/green earth wire must be connected to the screw with the symbol .

- Strip approx. 70 mm of the cable sheath from the power supply cable (G).
- Strip approx. 10 mm of sheath from the conductors. Insert the cable (G) through the opening in the lid (F).
- Insert the cable into the cable clamp and connect the conductors to the terminal block as indicated in the diagram printed on the lid.
- Secure the power cable (G) by means of the cable clamp.
- Refit the protection lid (F).
- After the electrical connection, fit the hob from the top and hook it to the fixing springs, according to the illustration.

Declaration of conformity

- This cooktop is suitable for contact with foodstuffs and complies with EEC (CE) Regulation n. 1935/2004.
- This hob (Class Y) has been designed to be used only for cooking. Any other use (such as heating a room) is improper and dangerous.
- This hob has been designed, constructed and marketed in compliance with:
 - safety objectives of the "Low Voltage" Directive 2006/95/EC (which replaces 73/23/EEC and subsequent amendments);
 - the protection requirements of Directive "EMC" 2004/108/EC;
 - requirements of EEC Directive 93/68.

The Manufacturer reserves the right to change product specifications without prior notice.

