

# BUSH

## Instruction manual

BUSH  
Tumble Dryer  
TD3CNBW



You'll soon be enjoying your new 'Tumble Dryer'.

It all begins here, with your instructions. Don't worry, there's nothing too technical coming up. Just simple, step-by-step guidance to get you up and running quickly. Sound good? Then let's get started.

## Help and Guidance

We're here to help you get the most from your 'Tumble Dryer'. Should you require any guidance, a simple solution can often be found online at:

**[www.bush-support.com](http://www.bush-support.com)**

If you still require further assistance, call one of our experts on **01759 487838**.

If you require any technical guidance or find that your product is not operating as intended, a simple solution can often be found in the **Troubleshooting** section of these instructions.

# Contents

## 1 Safety information

Safety information 6

## 2 Getting to know your 'Tumble Dryer'

Ready? Let's begin 10

Accessories 12

## 3 Installing your 'Tumble Dryer'

Installation requirements 14

Connections 15

Electrical connection 16

## 4 Functions

Functions 18

## 5 Using your 'Tumble Dryer'

Using your 'Tumble Dryer' 22

## 6 Care and Maintenance

Cleaning 26

Technical specifications 27

Product fiche 28

## 7 Product support

Troubleshooting 30

Help and assistance 31

Declaration of conformance to product standards 32

Disposal 33



If you require any technical guidance or find that your product is not operating as intended, a simple solution can often be found in the **Troubleshooting** section of these instructions.

# Safety information

1

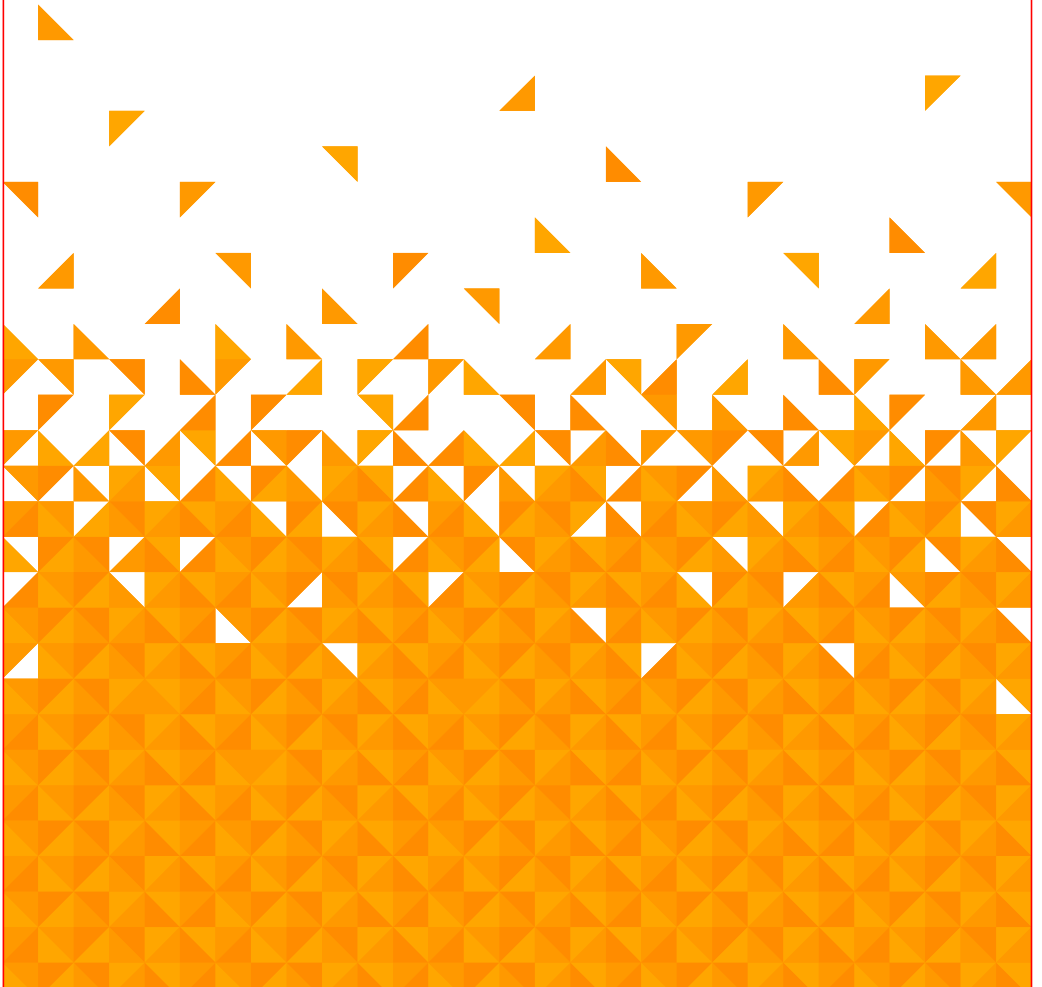



## Safety information

**Important** - Please read these instructions fully before installing or operating

### Before use

- The installation of this appliance is best carried out by 2 people.
- Dispose of all packaging carefully and responsibly.
- The appliance is designed for **indoor use only** and must be protected from rain, moisture and extreme temperature variations.
- This appliance is designed for household use. **Do not** use the appliance for Industrial and commercial use, or any other purpose.
- The appliance **MUST** be positioned on a firm level base.
- **Do not** splash water on the appliance. It may cause electrical parts to fail and result in an electric shock.
- For appliance with ventilation openings in the base, the carpet **must not** obstruct the openings.
- The appliance **must not** be installed behind a lockable door, a sliding door or a door with a hinge on the opposite side to that of the tumble dryer, in such a way that a full opening of the Tumble Dryer door is restricted.
- **Do not** sit, stand or place any other heavy objects on top of the appliance. This could result in injury or damage to the appliance.
- **Do not** allow children to play with the appliance to avoid the risk of entrapment and suffocation.
- Keep ventilation opening, in the appliance enclosure or in the built-in structure, clear of obstruction.

- The lint trap has to be cleaned frequently, if applicable.
- Clean lint screen before or after each load.
- Never use the dryer without the lint filter.

### During use

- This appliance can be used by children aged from 8 years and above and persons with reduced physical, sensory or mental capabilities or lack of experience and knowledge if they have been given supervision or instruction concerning use of the appliance in a safe way and understand the hazards involved. Children shall not play with the appliance. Cleaning and user maintenance shall not be made by children without supervision.
- The Tumble Dryer is not to be used if industrial chemicals have been used for cleaning.
- Do not allow lint to build up in and around the Tumble Dryer.
- Do not dry unwashed items in the tumble dryer.
- Items that have been soiled with substances such as cooking oil, acetone, alcohol, petrol, kerosene, spot removers, turpentine, waxes and wax removers should be washed in hot water with an extra amount of detergent before being dried in the Tumble Dryer.
- Items such as foam rubber(latex foam), shower caps, waterproof textiles, rubber backed articles and clothes or pillows fitted with foam rubber pads should not be dried in the Tumble Dryer.

If you require any technical guidance or find that your product is not operating as intended, a simple solution can often be found in the **Troubleshooting** section of these instructions.



## Safety information

**Important** - Please read these instructions fully before installing or operating

- Fabrics softeners, or similar products, should be used as specified by the fabric softener instructions.
- The final part of a Tumble Dryer cycle occurs without heat (cool down cycle) to ensure that the items are left at a temperature that ensure that the items will not be damaged.
- Remove all objects from pockets such as lighters and matches.
- **WARNING:** Never stop a Tumble Dryer before the end of drying cycle unless all items are quickly removed and spread out so that the heat is dissipated.
- Children of less than 3 years should be kept away unless continuously supervised.
- Do not attempt to repair the appliance yourself.  
Contact the Customer Helpline: 01759 487838.
- If the supply cord is damaged, it must be replaced by the manufacturer, its service agent or similarly qualified persons in order to avoid a hazard.
- Oil-affected items can ignite spontaneously, especially when exposed to heat sources such as in a Tumble Dryer. The items become warm, causing an oxidation reaction in the oil. Oxidation creates heat. If the heat cannot escape, the items can become hot enough to catch fire. Piling, stacking or storing oil-affected items can prevent heat from escaping and so create a fire hazard.
- If it is unavoidable that fabrics that contain vegetable or cooking oil or have been contaminated by hair care products be placed in a Tumble Dryer they should first be washed in hot water with extra detergent - this will reduce, but not eliminate, the hazard.



CAUTION: HOT SURFACE!



CAUTION: RISK OF FIRE!



If you require any technical guidance or find that your product is not operating as intended, a simple solution can often be found in the **Troubleshooting** section of these instructions.



Getting to know your  
'Tumble Dryer'

2

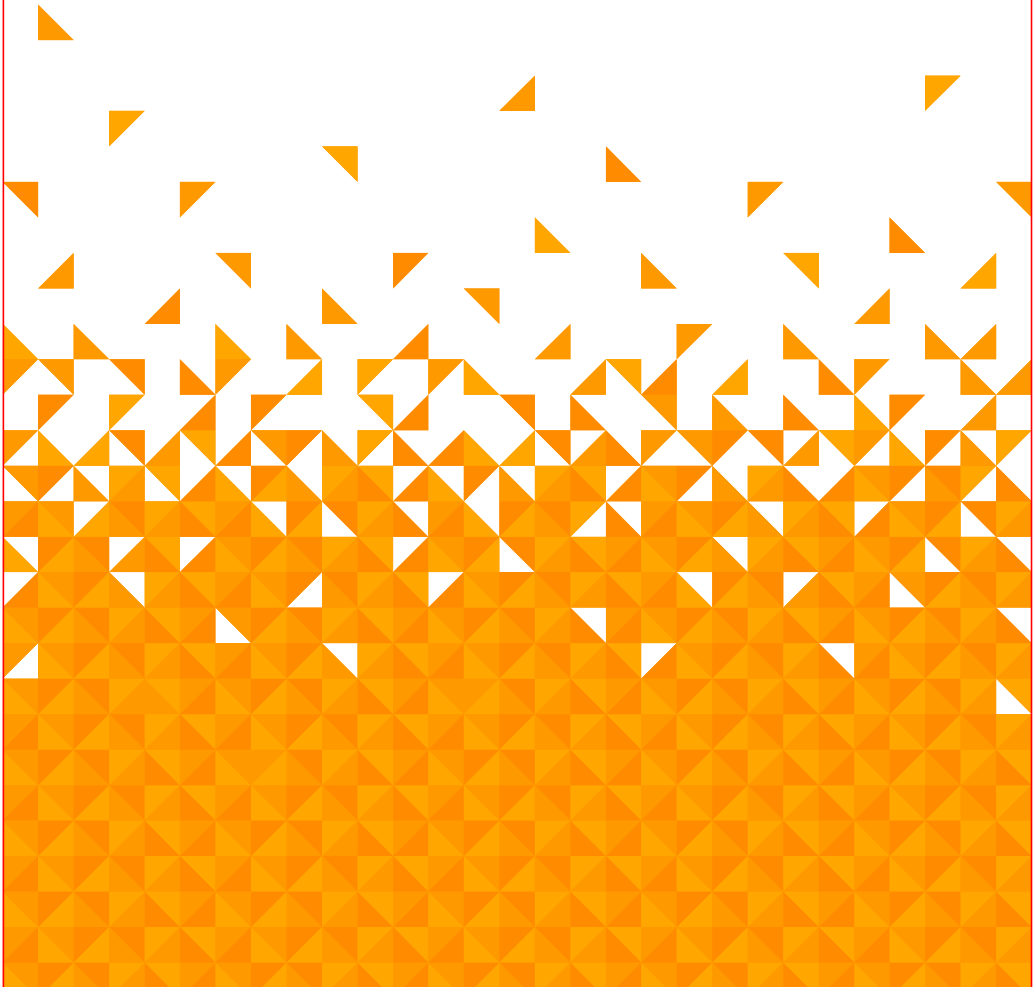

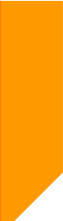

# Getting to know your 'Tumble Dryer'

## You'll be up and running in no time

### Ready? Let's begin...

Please read these instructions carefully. They contain important information which will help you get the best from your 'Tumble Dryer' and ensure safe and correct installation and operation.

If you require any further assistance, our technical experts are happy to help. For full details, refer to the product support section at the end of these instructions.

If you require any technical guidance or find that your product is not operating as intended, a simple solution can often be found in the **Troubleshooting** section of these instructions.

# Getting to know your 'Tumble Dryer'

## You'll be up and running in no time

### Component

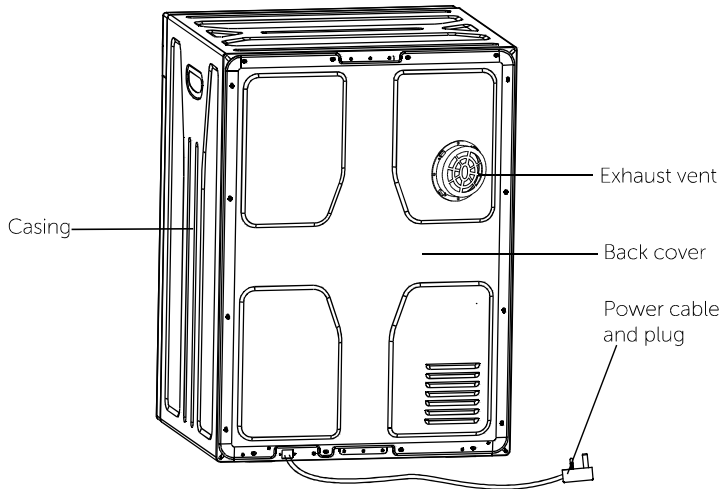
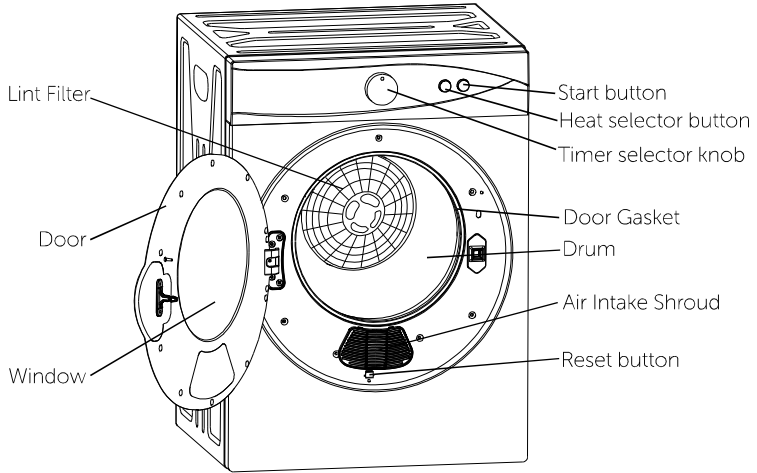

or online at [www.bush-support.com](http://www.bush-support.com) If you still require further assistance, call one of our experts on 01759 487838.

# Getting to know your 'Tumble Dryer'

## You'll be up and running in no time

Model	capacity	Energy class	Color
TD3CNBW	3kg	C	White

### Accessories

- Instructions X 1
- Exhaust Connector X 1
- Metal ring X 1
- Hose ( $\Phi 80 \times 1.5\text{m}$ ) X 1

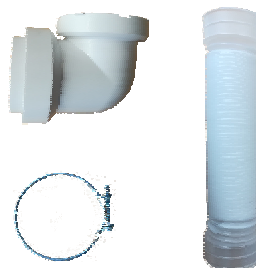

### Tools

You may use this tools to help install above parts

- glove
- Phillips screwdriver

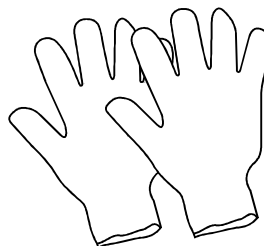

If you require any technical guidance or find that your product is not operating as intended, a simple solution can often be found in the **Troubleshooting** section of these instructions.

# Installing your 'Tumble Dryer'

3



# Installing your 'Tumble Dryer'

## Bringing it all together

### Installation requirements

#### Transportation

-  Caution: 2 people are required to unpack and handle the appliance, it is recommended that gloves are worn.
- The appliance should be transported only in an upright position. Do not tilt the appliance greater than 45°. The packaging as supplied must be intact during transportation.
- Do not move the appliance by pulling the door or handle as it may damage your flooring and wall coverings etc.
- Ensure the supply cable is not caught under the appliance during and after moving.
- Carefully remove all package materials including the foam base, dispose of correctly.

#### Unpacking Tumble Dryer

Caution: 2 people are required to unpack the Tumble Dryer, it is recommended that gloves are worn.

Carefully remove all packaging materials including the foam base, dispose of correctly.

#### Installation

- Ensure sufficient spacing is provided for the appliance to be installed. Leave space on back (15cm) to ensure proper ventilation.(Fig1)
- Install the Tumble Dryer in a well ventilated room.
- Make sure that your machine is not placed on the power cord.
- Do not place the appliance near a heat source or in direct sunlight.
- Do not put any heavy objects on top of the appliance. It will damage the appliance.
- Do not install the appliance in moist and wet place.(Fig2)
- Adjust the feet at front to level the appliance. It should be installed on a smooth surface to avoid excessive vibration and noise.
- Never unscrew the adjustable feet from their housings.
- Refer to section "User instructions" to prepare your appliance for use.

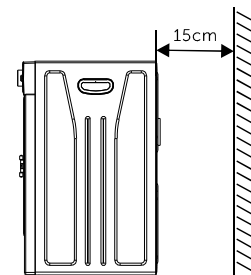

Fig1



Fig2

If you require any technical guidance or find that your product is not operating as intended, a simple solution can often be found in the **Troubleshooting** section of these instructions.

# Installing your 'Tumble Dryer'

## Bringing it all together

### Levelling feet

- 1: For your machine to work efficiently with minimum vibration it should be settled on flat, nonslippery, firm ground.
- 2: You can adjust the balance of your machine by changing the positioning of its feet.
- 3: First, loosen the plastic adjustment nut. (Fig 3)
- 4: Adjust by rotating the feet upwards or downwards.(Fig 4)
- 5: After the desired position has been reached, tighten the plastic adjustment nut again by rotating it upwards.

Note: Never put cartons, wooden blocks or similar materials under the machine to balance irregularities in the level of the ground.

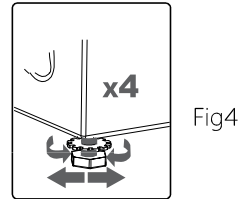
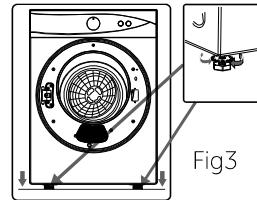

### Connections

#### Hose connection



**Warning:** 2 people may be required to install the hose. It is recommended to wear the gloves

**NOTE:** Ventilation hose assures exhausting of the air from the inside of the Tumble Dryer.

- Carefully remove all packing materials including from the foam, dispose of correctly.
- Before installation, ensure that the unit is power off and unplug from the mains.
  1. According to the order of arrows shown in Fig 5, three parts are combined into exhaust hose assembly.
  2. Put the exhaust hose assembly on the Connector Base in the desired direction (upper, lower, left, and right), as shown in Fig 6.
  3. Turn the exhaust hose assembly clockwise until it is clamped firmly, as shown in Figure 7.
- The air outlet hose must be extended directly to the outdoors. Keep bends to a minimum to ensure adequate ventilation.
- To prevent water accumulation in the hose, make sure the hose is not folded on the floor.
- In winter, the room temperature may be cold. The water may condense inside the hose. Periodical check is required to avoid hose damaged by the water.



**Warning:** Do not connect the hose to the chimney of a stove or fireplace.

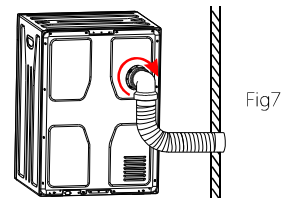
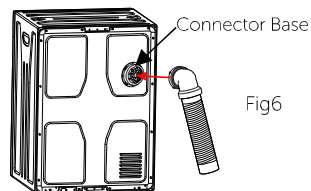
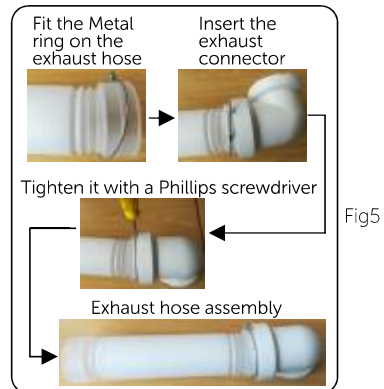

or online at [www.bush-support.com](http://www.bush-support.com) If you still require further assistance, call one of our experts on 01759 487838.

# Installing your 'Tumble Dryer'

## Bringing it all together

### Electrical connection



Any electrical work that is required to install this appliance **MUST** be carried out by a qualified electrician.



**Warning: THIS APPLIANCE MUST BE EARTHED**

Before making any electrical connections, ensure that:

- Electrical safety is only guaranteed when the earth system of your house is in accordance with the related local regulations.
- Do not bend, stretch or pull the supply cable to avoid electric shock.
- Ensure the power socket is suitable for the Maximum power of the machine (fuses in the power circuit must be 13 amp).
- The supply voltage should be the same as that indicated in the technical specifications and the appliance rating plate.
- The appliance should be earthed and in compliance with the applicable law.
- When installed, the power socket must be within easy reach.
- If the socket outlets in your home are not suitable for the plug supplied with this unit check with a qualified electrician for replacement.
- To avoid the risk of overloading your plug socket, the use of adapters, multiple connectors or extension cables are not recommended. The appliance must be connected to a 220-240 volt 50Hz AC supply by means of a three pin socket, suitably earthed and protected by a 13 amp fuse.
- Should the fuse need to be replaced, a 13 amp fuse approved to BS1362/A must be used.
- The plug contains a removable fuse cover that must be refitted when the fuse is replaced. If the fuse cover is lost or damaged, the plug must not be used until a replacement cover has been fitted or the plug is replaced.
- A damaged plug should be cut off as close to the plug body as possible, the fuse should be removed and the plug disposed of safely.

### Plug replacement (UK & Ireland only)

Should you need to replace the plug; the wires in the power cable are coloured in the following way:

Blue - Neutral 'N'

Brown - Live 'L'

Green & Yellow - Earth 'E'

As the colours of the wires in the power cable may not correspond with the coloured markings identifying the terminals in your plug, and proceed as follows(Fig8):

The green & yellow wire must be connected to the terminal in the plug that is marked with the letter E or by the earth symbol.

The blue wire must be connected to the terminal that is marked with the letter N.

The brown wire must be connected to the terminal that is marked with the letter L.

If power supply cord is damaged, it must be replaced by the manufacturer or its service agent or a similar qualified person in order to avoid a hazard.

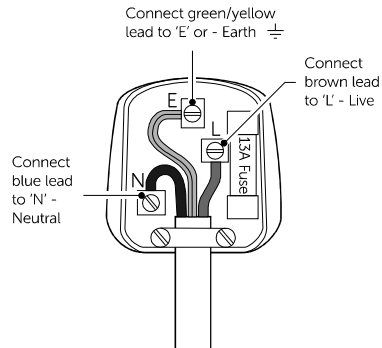

Fig8

If you require any technical guidance or find that your product is not operating as intended, a simple solution can often be found in the **Troubleshooting** section of these instructions.



# Functions 4



# Functions

## Heat Selector button

Select 'High Dry' for items than are particularly bulky or large quantities.

Select 'Low Dry' for delicate items such as silk, nylon, linen etc.



## Drying Program Selector

There are five drying combinations available: Cool, Anti-wrinkle, Warm, Hot and Air dry.

**Air Dry:** This function runs with cool air, primarily to air items that require freshening, i.e.: clothes that have been stored for a long period of time.

**OFF:** When the 'Drying Timer' dial is in the 'OFF' position no power is supplied to the unit. As soon as the dial is turned clockwise to the desired program, the dryer will start.

**Cool:** This function is generally used to cool the items that have just been dried. This helps to prevent creasing. Instead of the motor pushing heat into the drum of the dryer it will generate cool air.

**OFF:** When the 'Drying Timer' dial is in the 'OFF' position no power is supplied to the unit. As soon as the dial is turned clockwise to the desired program, the dryer will start.

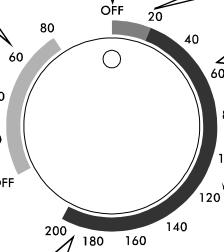

**Anti-wrinkle:** This is used for items that are difficult to iron i.e.: cotton shirts and linen. Using the heat selector knob, choose 'Low'. Set the drying timer knob between 30-60 minutes depending on the amount of items in the dryer. Once the timer stops (including the cool program) the items will still contain moisture, making the ironing process easier.

**Hot:** For drying large quantities or bulky items (More than 0.5 times the rated capacity). Select the 'High' heat option and set the timer for more that 120 minutes.

**Warm:** This function will dry and cool items and in most cases leave items wrinkle free (depending on material). Select the 'High' heat option and set the timer for more that 60-120 minutes.

## Start button

After having set up the Heat Selector and Timer Dial, press the Start button.

The dryer will start and work until the program is finished. If the during this process the door is opened or power is switched off, the dryer will stop working. In order to start the dryer again after the door is closed or power is switched back on, you will need to push the Start button, then the dryer will start working again.



**NOTE:** This Start button is only designed to start the dryer working. If you press this button during the drying process, the dryer will not pause. In order to stop the dryer, you must turn the timer dial to OFF position.

If you require any technical guidance or find that your product is not operating as intended, a simple solution can often be found in the **Troubleshooting** section of these instructions.

# Functions

**Drying time reference table**

Drying Capacity	Clothes	Dry time	
		High	Low
Approx 1kg	Cotton	Approx 70min	Approx 110min
	Synthetic	Approx 50min	Approx 80min
	Mixed	Approx 60min	Approx 95min
Approx 2kg	Cotton	Approx 120min	Approx 170min
	Synthetic	Approx 90min	Approx 130min
	Mixed	Approx 105min	Approx 150min
Approx 3kg	Cotton	Approx 180min	-
	Synthetic	Approx 140min	-
	Mixed	Approx 160min	-

- All values given in the table have been fixed according to EN61121:2013 Standard. These values may deviate from the table according to the laundry type, laundry spin speed, environment condition and voltage fluctuation.

# Functions

## Simple everyday use

### Ending the program – Cancelled by customer

To cancel the program:

1. Open the door, the machine will stop immediately and wait for five minutes to let the temperature inside cool down.
2. Remove the clothes



**Warning:** The temperature inside the dry drum may still be high. Take extra care when removing the clothes.

- Clean the drum and lint filter after each drying.

### Overheat Safety device

This machine is equipped with an overheat safety device that switches off the machine in the event of overheating. Should the machine stop heating, turn the machine off and inspect lint filter or exhaust outlet or ventilation of the laundry room. Blockage on the filter & exhaust outlets (hose) and poor ventilation in laundry room will cause the overheating on the machine. Clean the blockage on filter & exhaust outlet and open the window in the laundry room to improve the situation. Wait for at least 10 minutes for the machine to cool down. Then push up the reset button under the air lint filter in front of the door.

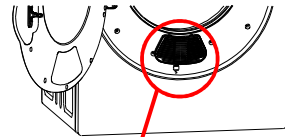

Reset button - Push up with your fingers when manual reset is needed.

If you require any technical guidance or find that your product is not operating as intended, a simple solution can often be found in the **Troubleshooting** section of these instructions.

# Using your 'Tumble Dryer' 5

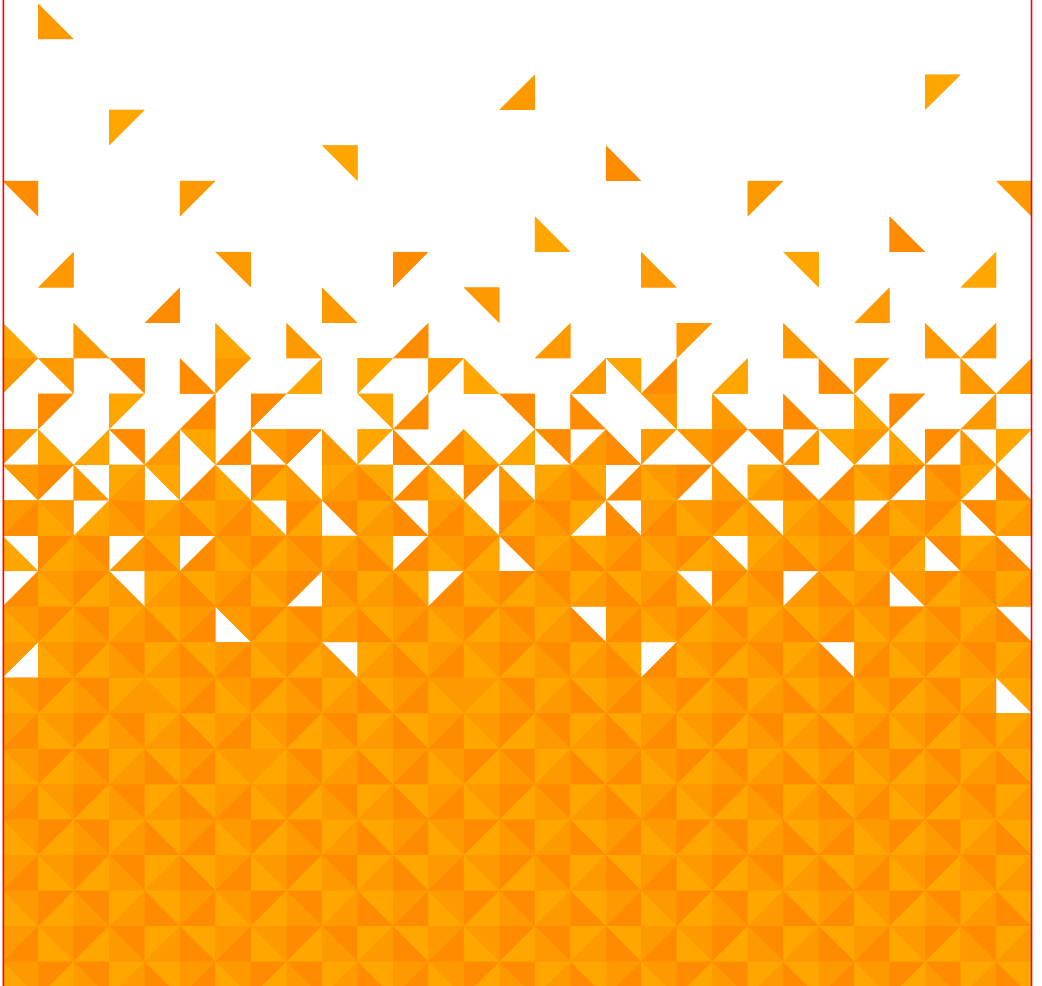

# Using your 'Tumble Dryer'

## Getting the most from your appliance

### Before first use

Final checks before operating the appliance

1. Good air circulation around the appliance positioned appliance.
2. The feet have been adjusted for perfect leveling.
3. Check the hose has been extended to the outdoors.
4. Plug in the appliance.

### Garments suitable for drying in Tumble Dryer

Before using the Tumble Dryer, you have to ensure the laundry is suitable to dry in the Tumble Dryer. Always follow the advice on the garment labels. Dry only laundry with a label stating they are suitable for drying in the dryer and select the appropriate program.



Dry

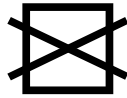

Do not dry

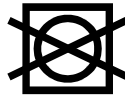

Do not tumble dry



Tumble dry, high heat



Tumble dry, middle heat



Dry horizontally



Hang without spinning



Dry on a hanger



Tumble dry, low heat

### Garment NOT suitable for drying in Tumble Dryer

- Do not dry articles that have been previously cleaned in, washed in, soaked in or spotted with Petrol,/gasoline, dry-cleaning solvents or other flammable or explosive substances as they give off vapors that could ignite or explode.
- Do not dry the articles containing rubber, plastic or similar elastic materials such as padded bras, tennis shoes, galoshes, bath mats, rugs, bibs, baby pants, raincoat plastic bags or pillows that may melt or burn. Some rubber materials, when heated, can under certain circumstances produce fire by spontaneous combustion.
- Do not dry clothes / articles made of foam or rubber as they may be deformed.
- Clothes / articles made of containing meal, hard plastic and similar materials, such as belt buckles, jeans, bra wires, buttons and similar accessories will damage the machine and may cause breakdown.
- Do not place such items in the Tumble Dryer.
- Do not dry items such as woolen, silk articles and nylon stockings, delicate embroidered fabrics, garments with metal accessories and items such as sleeping bags.
- Too wet laundry or laundry with dripping water must not be put into the Tumble Dryer.

### Preparation for the clothes to be dried

- Thoroughly spin the laundry in washing machine. High spin speed can reduce the drying time and save energy consumption.
- Separate your laundry before placing them into the Tumble Dryer.
- Sort the laundry according to their types thickness. Put the same type of laundry together.

If you require any technical guidance or find that your product is not operating as intended, a simple solution can often be found in the **Troubleshooting** section of these instructions.

# Using your 'Tumble Dryer'

## Getting the most from your appliance

### Load capacity



**Caution** : Overload is not recommended. The drying performance will be degraded when it is overloaded. The machine and your clothes may get damaged. Please refer to the program table to select the desire loading for each setting. Do not overloaded the machine.

- Following table can provide you the idea of the weight for different kind of clothes.

Articles / Clothes	Approx. Weight(g)
Cotton quilt covers(single/double)	900/1500
Bed sheets (single/double)	600/900
Work clothes	1120
Large tablecloths	700
Small tablecloths	350
Tea napkins	100
Bath towels	700
Hand towels	300
Blouses	150
Cotton shirts	300
Shirts	180
Cotton dressed	500
Jeans	800
Jacket	800
Handkerchiefs	100
T-shirts	150
Shorts	70
Socks	50

- Place your clothes into dryer loosely so that they have enough room during and will not get tangled.

# Using your 'Tumble Dryer'

## Getting the most from your appliance

### Quick start

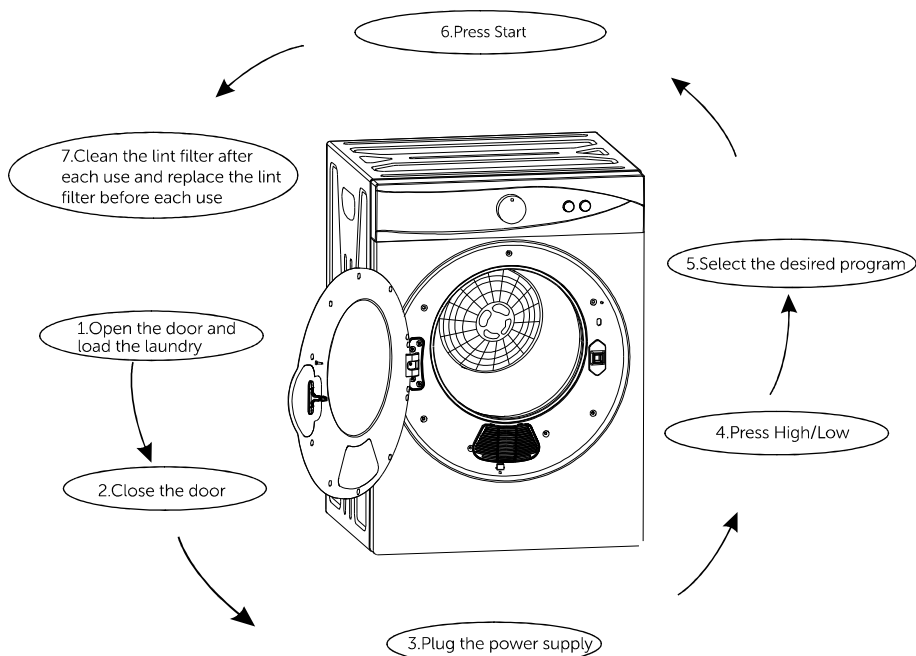

If you require any technical guidance or find that your product is not operating as intended, a simple solution can often be found in the **Troubleshooting** section of these instructions.



# Care and maintenance

6

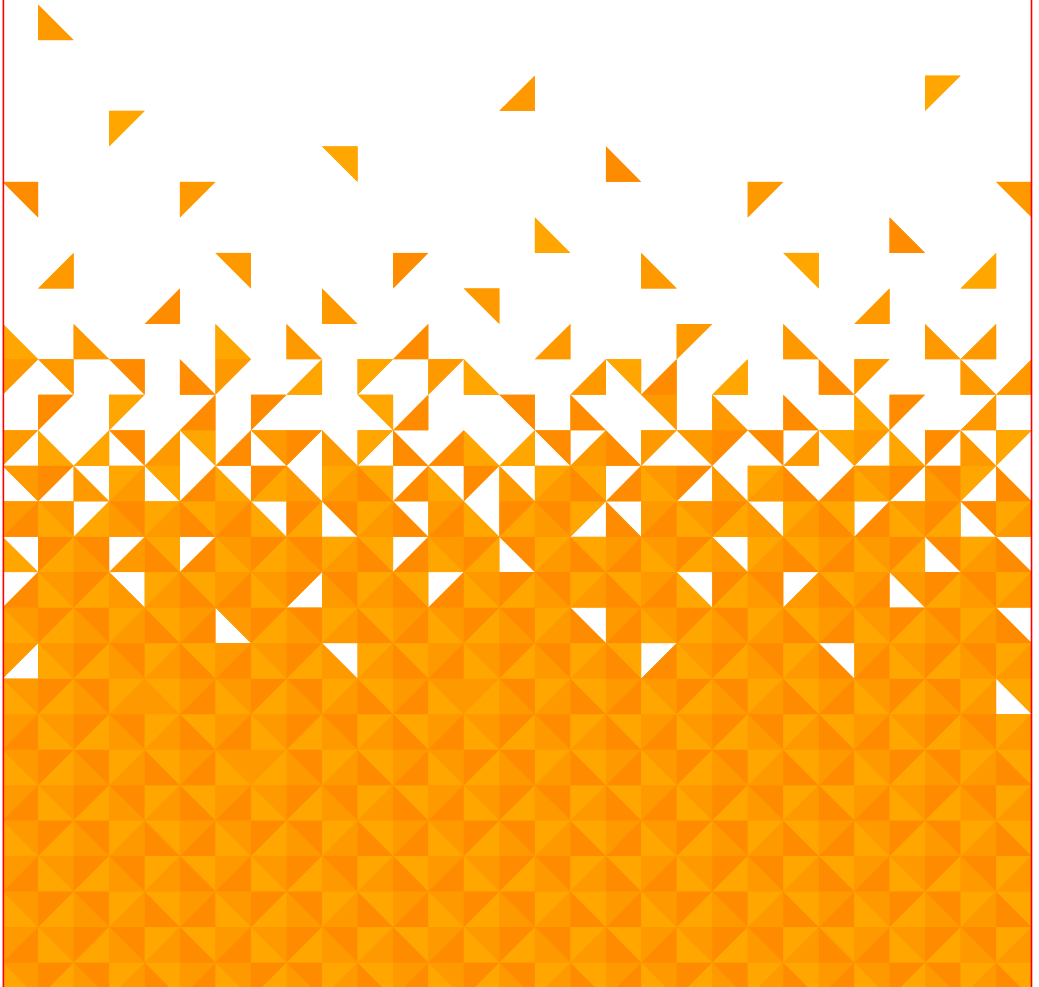

# Care and maintenance

## Looking after your appliance

### General



**Important: Always unplug the appliance from the power socket during cleaning and maintenance.**

- Never use any sharp instruments or abrasive substance, soap, household cleaner, detergent or wax polish for cleaning.
- Use luke warm water to clean the cabinet of the appliance and wipe it dry.
- Never clean the appliance with flammable fluids. It could cause a damage and fire hazard.
- Clean the exterior of the appliance, inner tube and door seal with a damp cloth. Open the door for aeration to dry the inner tube through.
- Avoid water going in the control panel. Clean with a dry cloth only.
- Clean the lint filter after each use.

### Clean the lint filter



**Important: Always unplug the appliance from the power socket during cleaning and maintenance.**

#### 1. Removing the filters

Remove by pulling outwards with fingers, inserted into the four holes around the exhaust vent shroud. The filter is in 3 parts: Exhaust vent shroud, lint filter and exhaust filter (as shown in Fig8)

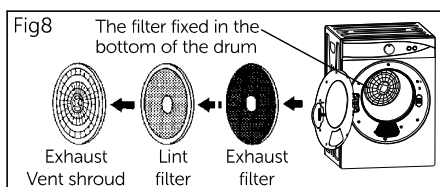

#### 2. Cleaning the filter

Separate 'exhaust vent shroud', 'lint filter' and 'exhaust filter'. Clean the lint on the lint filter and exhaust filter with a soft brush or vacuum cleaner. Do not damage the filters (as shown in Fig9).

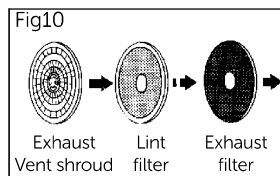
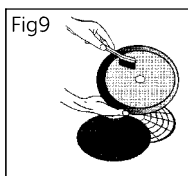

#### 3. Re-installing the filter

After cleaning, assemble in the sequence of 'exhaust filter - lint filter - exhaust vent shroud', align the recesses in the center with the projection in the center of the drum. Make sure that it is firmly inserted (as shown in Fig10).

### Cleaning of the Air Intake Filter



**Important: Always unplug the appliance from the power socket during cleaning and maintenance.**

The filter should be cleaned once a month. Remove by pulling outwards holding the upper and lower ends of the air intake shroud. Remove the filter inside the shroud and clean it with a soft brush. Reassemble and install as before.



If you require any technical guidance or find that your product is not operating as intended, a simple solution can often be found in the **Troubleshooting** section of these instructions.

# Care and maintenance

## Looking after your appliance

### Technical specification

Model	TD3CNBW
Energy efficiency class	C
Energy consumption - per year	243kWh
Rated capacity (max.)	3kg
Operating noise level dB(A)	60
Product dimension	H690xW490xD475
Net Weight	20.5kg
Rated power input	1020W
Rated voltage/Frequency	220-240V~/50Hz
Minimum operation temperature	-10°C

**NOTE:**

1 A+++ (most efficiency) to D (least efficiency)

2 Energy consumption kWh per year, based on Standard cotton program at full (3kg) and partial load, and the consumption of the low-power modes. Actual energy consumption per cycle will depend on how the appliance is used.

We apologise for any inconvenience caused by any minor inconsistencies in these instructions, which may occur as a result of product improvements and development.

# Care and maintenance

## Looking after your appliance

### Product fiche

Brand	BUSH
Model	TD3CNBW
Dryer Type	Air-Vented
Rated capacity	3 kg
Energy efficiency class <b>1</b>	C
Energy consumption <b>2</b>	243 kWh
Automatic or non-automatic	Non-automatic
EU Ecolabel	N/A
Energy consumption of the standard cotton programme at full load	2.13 kWh
Energy consumption of the standard cotton programme and partial load	1.07kWh
Power consumption of the off-mode (Po)	0 W
Power consumption of the left-on mode (Pl)	0 W
Duration of the left-on mode	N/A
Weighted programme time of the standard cotton programme at full and partial load	99 min
Programme time of the standard cotton programme at full load	141 min
Programme time of the standard cotton programme at partial load	68 min
Sound power level for the standard cotton programme at full load	60 dB
<p>Cotton + Standard programme, which is the “standard cotton programme”            Used at full and partial load is the standard drying programme to which the information in the label and the fiche relates, that this programme is suitable for Drying normal wet cotton laundry and that it is the most efficient programme in Terms of energy consumption for cotton.</p>	

#### NOTE:

1 A+++ (most efficiency) to D (least efficiency)

2 Energy consumption 287 kWh-per year, based on 160 drying cycles of the standard cotton programme at full and partial load, and the consumption of the low-power modes/ Actual energy consumption per cycle will depend on how the appliance is used.

We apologise for any inconvenience caused by any minor inconsistencies in these instructions, which may occur as a result of product improvements and development.

If you require any technical guidance or find that your product is not operating as intended, a simple solution can often be found in the **Troubleshooting** section of these instructions.

Product support

7

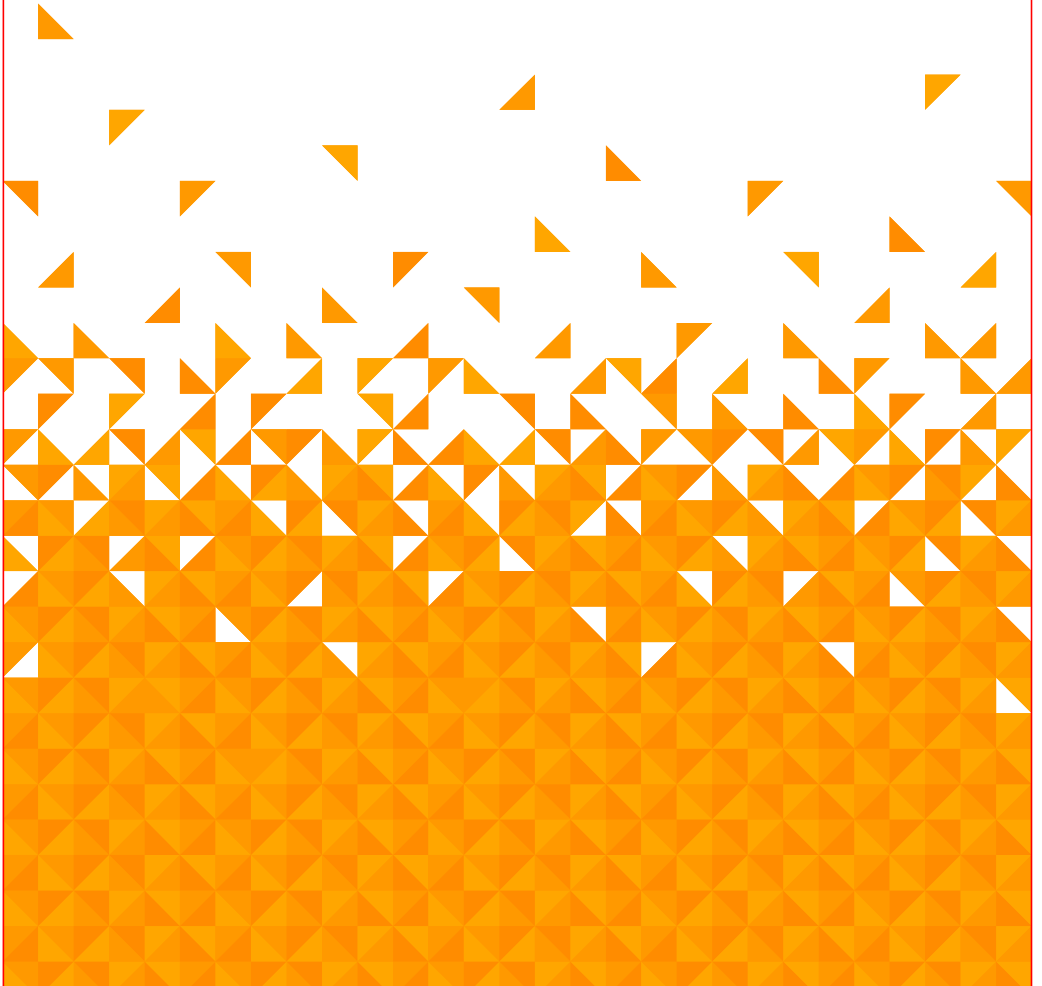

## Product support

### Help is always at hand

#### Troubleshooting

1. Tumble dryer doesn't operate?

Please make sure the power plug was inserted well and check the protection devices and fuses.

2. Laundry has shrunk?

Please review the advice on the garments label to select the suitable program setting.

3. Laundry not dry enough at the end of drying?

Please reduce the quantity of clothes for drying each time and clean the lint filter after each use.

4. Laundry too dry?

Please take out the clothes immediately while the drying cycle is finished and review the advice on the garments label to select the suitable program setting.

5. The Tumble Dryer is noisy?

Please make sure the Tumble Dryer was installed on an even and leveled surface. The Tumble Dryer feet can be adjusted.

6. Where to buy the lint filter?

If you wish to replace any of the lint filter assembly, please contact the customer care number: 01759 487838.

If you require any technical guidance or find that your product is not operating as intended, a simple solution can often be found in the **Troubleshooting** section of these instructions.

# Product support

## Help is always at hand

### Help and assistance

If you require any technical guidance or find that your 'Tumble Dryer' is not operating as intended, a simple solution can often be found in the **Troubleshooting** section of these instructions or online at [www.bush-support.com](http://www.bush-support.com)

If you still require further assistance, call one of our experts on **01759 487838\*** . To help give us give you a fast and efficient service please have the following information ready:

Model Ref.	<input type="text"/>	You can find these on the rating plate - a small information panel (usually a sticker or metal plate) on the rear of your appliance
Serial number	<input type="text"/>	
Date of purchase	<input type="text"/>	This will be shown on your receipt

Local call rates applies\*

Lines open 8am-7pm Monday to Saturday and 10am-4pm Sunday.

\*Calls to Bush enquiry lines may attract a charge and set up fee from residential lines depending on your call plan/tarif. Mobile and other providers costs may vary, see [www.bt.com/pricing](http://www.bt.com/pricing) for details.

For Security and training purposes, telephone calls to and from customer service centres maybe recorded and monitored. Calls from Republic of Ireland will attract international call charges.

or online at [www.bush-support.com](http://www.bush-support.com) If you still require further assistance, call one of our experts on **01759 487838**.

## Product support

Help is always at hand



This appliance complies with the following EEC directives:  
Low Voltage Directive (2014/35/EU)  
EMC Directive (2014/30/EU)

### Notes on disposal:



This marking indicates that this product should not be disposed with other household wastes throughout the EU. To prevent possible harm to the environment or human health from uncontrolled waste

disposal, recycle it responsibly to promote the sustainable reuse of material resources. To return your used device, please use the collection systems or contact the retailer where the product was purchased. They return and can take this product for environmental safe recycling.

**Remember: Old machine must be disposed of carefully – Cut off the mains plug and /or remove the door to be unusable before disposed – if in doubt, contact your local council for details on how to dispose of an old dryer.**

If you require any technical guidance or find that your product is not operating as intended, a simple solution can often be found in the **Troubleshooting** section of these instructions.



## Product support

Help is always at hand

# BUSH

### Call us now and activate your 12 month guarantee

Thank you for choosing Bush. Your new product is guaranteed against faults and breakdowns for 12 months. Don't forget to register it with us today so we can provide you with our best possible after-sales service and useful updates.

**[www.bushregistration.co.uk](http://www.bushregistration.co.uk)**

FREEPHONE\*

**0800 597 8548**

Lines are open 8am - 8pm, 365 days a year. \*Calls may be recorded and monitored.

### Your Bush Guarantee

This product is guaranteed for twelve months from the date of original purchase. Any defect that arises due to faulty materials or workmanship will be repaired free of charge (or if applicable the product will be replaced or the purchase price refunded) where possible during this period by the dealer from who your purchased the unit.

The guarantee is subject to the following provisions:

- The guarantee does not cover accidental damage, misuse, cabinet parts, knobs or consumable items.
- The product must be correctly installed and operated in accordance with the instructions contained in the manual.
- It must be used solely for domestic purposes. The guarantee will be rendered invalid if the product is re-sold or has been damaged by inexpert repair.
- Specifications are subject to change without notice.
- Bush disclaim any liability for loss or damage arising from the breakdown of the product.
- This guarantee is in addition to and does not diminish your statutory or legal rights.

### Important Data Protection Information

To find out how we and Domestic & General Insurance Plc use your data please refer to the guarantee registration material or visit [www.bushregistrations.co.uk](http://www.bushregistrations.co.uk).

Guarantor: Argos Limited - 489 - 499 Avebury Blvd. - Milton Keynes - MK9 2NW

or online at [www.bush-support.com](http://www.bush-support.com) If you still require further assistance, call one of our experts on **01759 487838**.



If you require any technical guidance or find that your product is not operating as intended, a simple solution can often be found in the **Troubleshooting** section of these instructions.



or online at [www.bush-support.com](http://www.bush-support.com) if you still require further assistance, call one of our experts on **01759 487838**.

# BUSH

**Contact:**

[www.bush-support.co.uk](http://www.bush-support.co.uk)

Helpline: 01759 487838