

## USING YOUR SOFA BED

**FROM SOFA TO BED:** Unzip the back and drop down the support legs before converting to a sofa bed. Hold the back of the sofa and tilt forward towards seat until you hear **ONE** click. Gently tilt the back into the bed position.

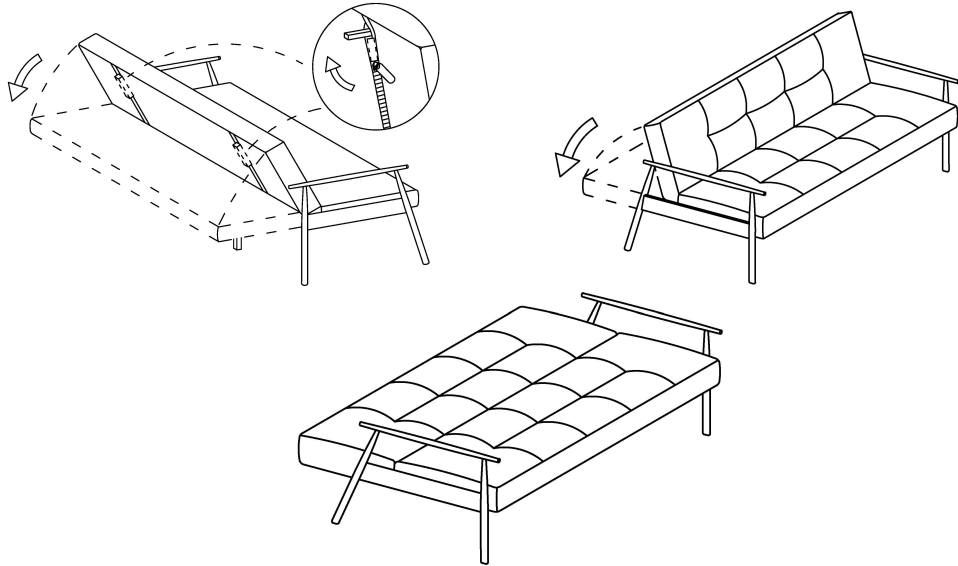

**FROM BED TO SOFA:** Lift the back until you hear **ONE** click to place it in a recliner position. Lift the back until you hear **TWO** clicks for the fully upright sofa position.

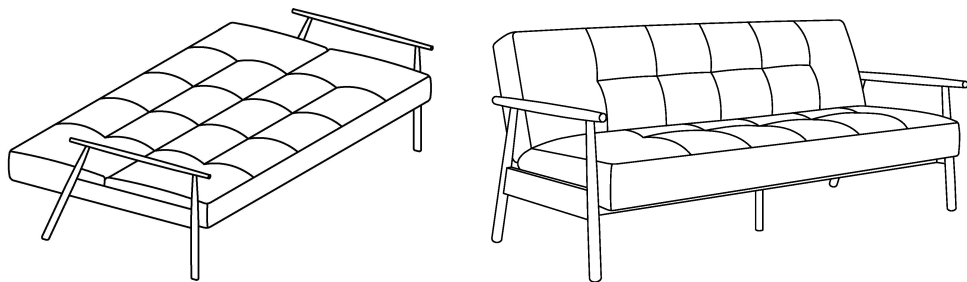

FABRIC CONTENT  
MAIN FABRIC 100% POLYESTER  
OTHER FABRIC (VISIBLE)  
NON-WOVEN FABRIC 100% POLYESTER

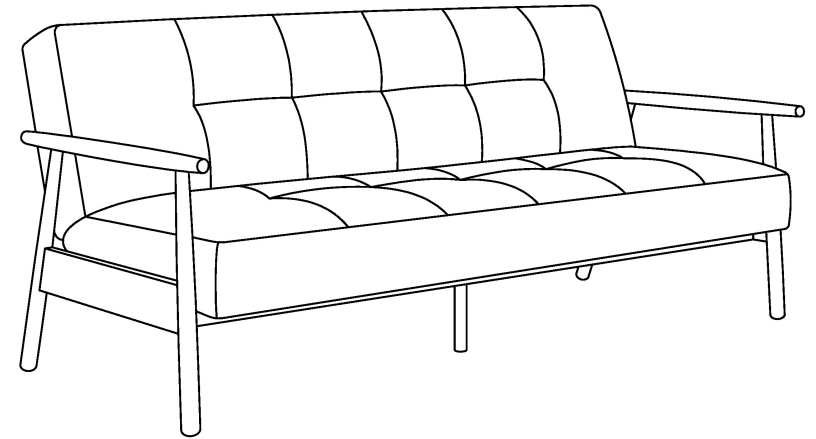

## KY480 CLICK CLACK SOFA BED

Thank you for your purchase. The following care instructions will allow you to make the most of your sofa bed; helping to prolong the look and life of it by preventing wear and damage.

### IMPORTANT INFORMATION

**PLEASE ENSURE YOU READ THIS LEAFLET BEFORE USING YOUR SOFA BED. DO NOT DISCARD OF ANY PACKAGING UNTIL YOU HAVE CHECKED THE PRODUCT THOROUGHLY.**

### CARING FOR YOUR SOFA BED

- Pre-brush fabric with a soft brush and then gently vacuum.
- Plump any accent/removable cushions regularly to prevent them becoming mis-shaped or flat.
- Use a microfibre cloth to remove dust from wooden surfaces.
- In the event of a spill or stain, use specialist upholstery cleaner or cleaning services.









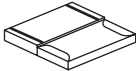

### SUNLIGHT AND HEAT DAMAGE

- Avoid contact with direct sunlight. If needed, move items or change their position to avoid the same area being exposed to repeated sunlight/heat.
- Do not place your sofa bed close to fire places and/or radiators.
- Hot objects such as mugs/plates can permanently mark the fabric and wood, avoid placing these on the sofa bed.

## SAFETY WARNINGS

- Do not allow children or pets to climb or jump on the chair or through the arms.
- Avoid contact with sharp objects such as buckles, toys and jewellery as these can easily snag, tear and/or pull the fabric.
- Avoid the risk of entrapment by using the sofa bed as intended; sitting facing forward on the seat.
- Keep small parts away and out of reach of children and pets.
- Do not allow children to operate the sofa bed mechanism.

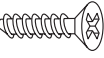
## PARTS LIST

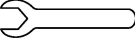
IMAGE	DESCRIPTION	PART NO.	QTY
	Seat Section	A	1
	Arms	B	2
	Support Leg	C	1
	Front Support Rail ( 1 central hole)	D	1
	Back Support Rail ( 3 holes)	E	1
	Bolt M8 x 90mm	F	6
	Washer	G	14
	Nut	H	6
	Bolt M8 x 20mm	I	8
	Screw	J	4
	Screw Driver	K	1
	Allen Key	L	1
	Spanner	N	1

## ASSEMBLY INSTRUCTIONS

Unpack your sofa bed and check that all the parts on the Parts List are present - these may be in a zip compartment within the base.

If any are missing, please contact the retailer from whom you purchased the product.

We would advise having two people to assemble this product.

### STEP 1

Assemble your sofa bed on a flat, soft surface to prevent any damage. Attach Bolts (F) to Arms (B), and unzip the bottom of the Seat Section (A), then attach the Arms (B) to the Seat Section (A) with Washers (G) and Nuts (H) using the Spanner (N).

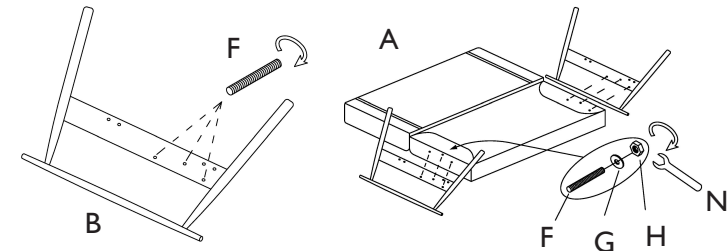

### STEP 2

Connect the Support Bars (D&E) to the Arm (B) with the Bolts (I) and Washers (G) using the Allen Key (L) as shown below, then secure the Support Bars (D&E) with the Screws (J) using the Screw Driver (K).

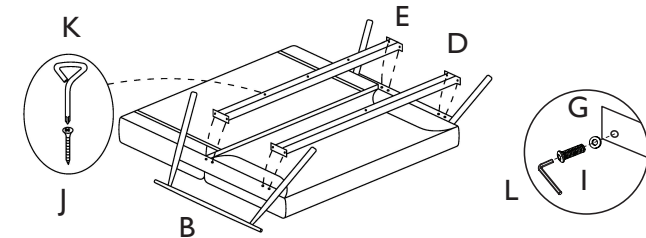

### STEP 3

Attach the Support Leg (C) as shown below.

Carefull, place the sofa bed on its legs - your sofabed is now ready for use.

