

Floating Shelf 120cm

Assembly Instructions - Please keep for future reference

875/2886

875/3696

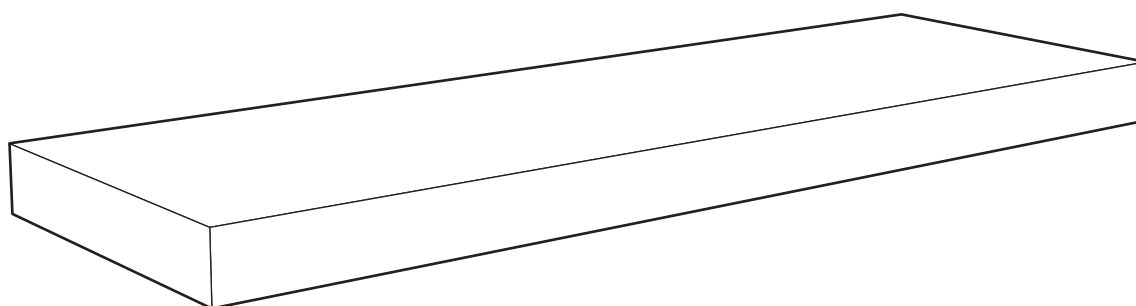

Dimensions

Width - 120cm

Depth - 25cm

Height - 4.5cm

Important - Please read these instructions fully before starting assembly

If you need help or have damaged or missing parts, call the **Customer Helpline: 08456 400800**



Safety and Care Advice

Important - Please read these instructions fully before starting assembly

- Check you have all the components and tools listed on pages 2 and 3.
- Remove all fittings from the plastic bags and separate them into their groups.
- Keep children and animals away from the work area, small parts could choke if swallowed.
- Make sure you have enough space to layout the parts before starting.

- Do not stand on the panels, this could cause damage.
- Assemble the unit as close to its final position (in the same room) as possible.
- Assemble on a soft level surface to avoid damaging the unit or your floor.
- Parts of the assembly will be easier with 2 people.



- We do not recommend the use of power drill/ drivers **for inserting screws**, as this could damage

the unit. Only use hand screwdrivers.

- Dispose of all packaging carefully and responsibly.
- **Warning:** Maximum allowable weight for this shelf is 7kgs.

Care and maintenance

- Only clean using a damp cloth and mild detergent, do not use bleach or abrasive cleaners.
- From time to time check that there are no loose screws on this unit.
- This product should not be discarded with household waste. Take to your local authority waste disposal centre.

Components - Panels

If you have damaged or missing components, call the **Customer Helpline:08456 400800**

Please check you have all the panels listed below



1 Top (120 x 25cm)

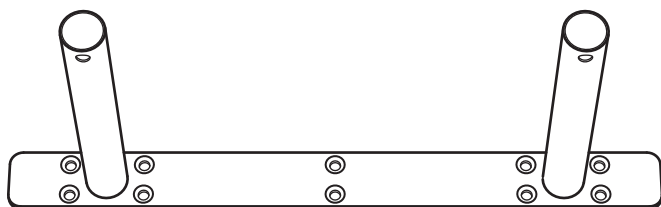





2 Support (65 x 15.3cm) (pre-fixed in the shelf)

Components - Fittings

Please check you have all the fittings listed below

Note: The quantities below are the correct amount to complete the assembly. In some cases more fittings may be supplied than are required.

<p>A  22mm Screw (pre-fixed in the shelf) x 2</p>	<p>B  Sticker x 2</p>	<p>C  Wall plug x 5</p>
<p>D  32mm Screw for wall plug x 5</p>		

Tools required

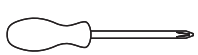

Phillips screwdriver
(medium & large)

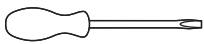

Flatblade screwdriver
(medium)

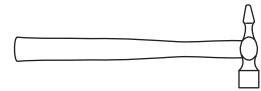

Small
hammer

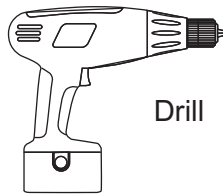

Drill



7mm Masonry drill bit
(for use with wall plug)

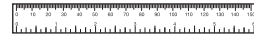

Ruler/tape
measure

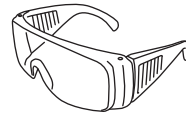

Eye protection
(when using a
hammer or glue)

Ruler - Use this ruler to help correctly identify the screws

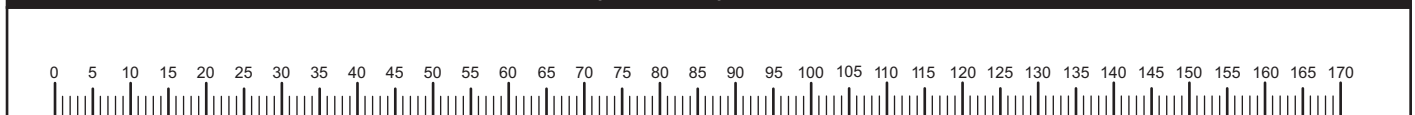

Assembly Instructions

Step 1

Wall mounting

Note: It would be useful to ask someone to help you at this stage.



Important: When drilling into walls always check that there are no hidden wires or pipes etc. Make sure that the screws and wall plugs supplied are suitable for supporting the unit. Consult a qualified tradesperson if you are not sure.

a: Loosen the Screws **A** from the Shelf **1**.
Take out Support **2** from the unit.

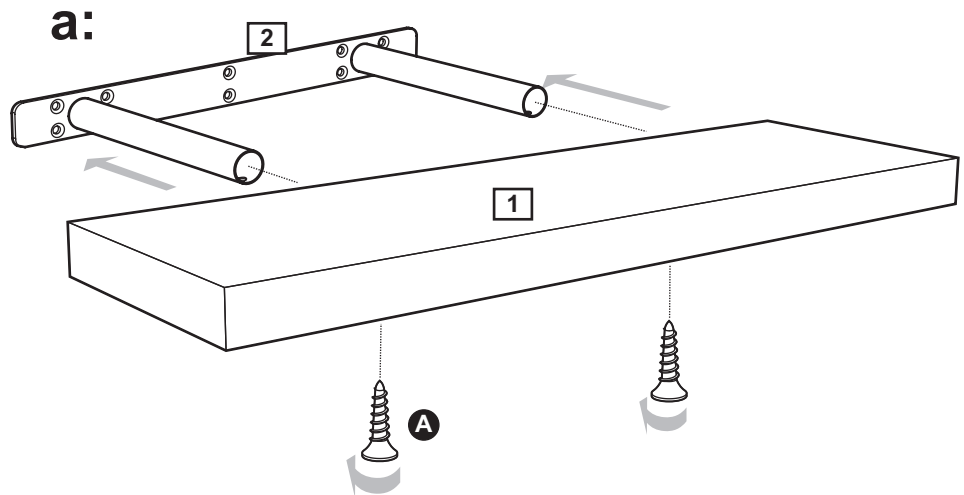

b: Using a drill, predrill a hole according to the Support **2** at the desired height.

Use the Wall plugs **C** and Screws **D** to fix the Support **2** onto the wall.

Note: The holes on the Support **2** always toward underside.

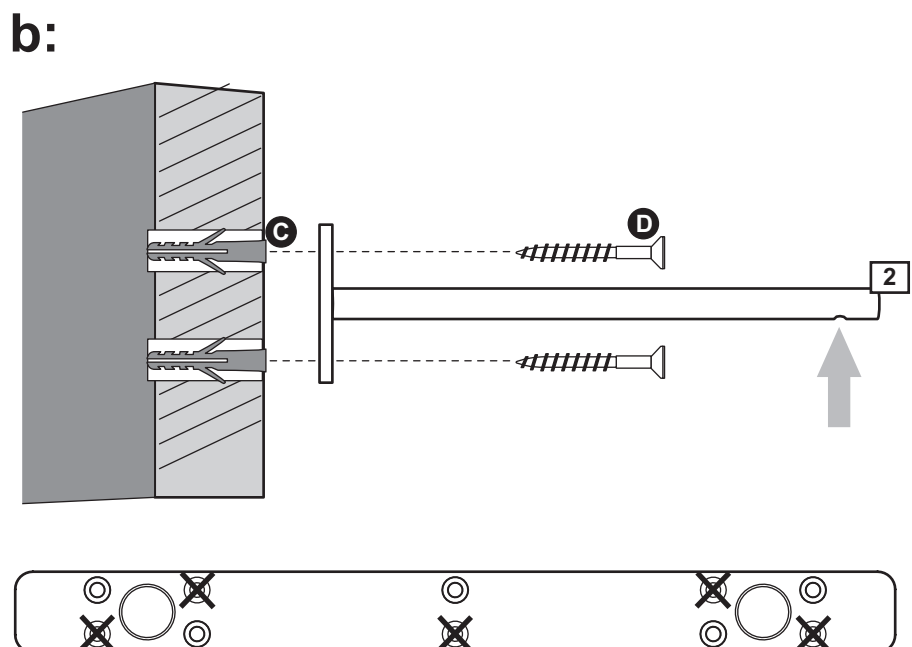

Assembly Instructions

Step 2

Finishing the unit

Note: It would be useful to ask someone to help you at this stage.

a: Insert the Shelf **1** onto the finished Support **2**.

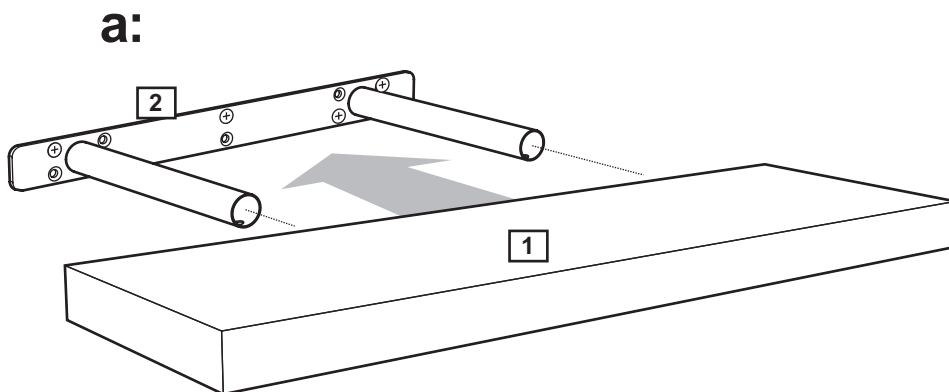

b: Use Screws **A** to fix the Shelf **1** onto the Support **2**.

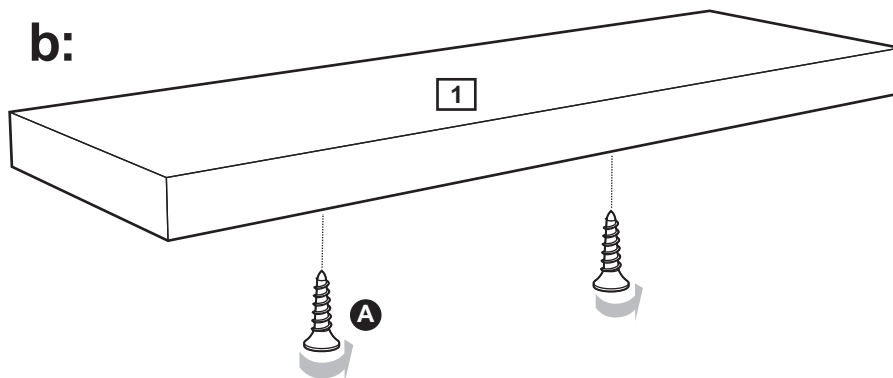

c: Use Cover caps **B** to cover the screw head.

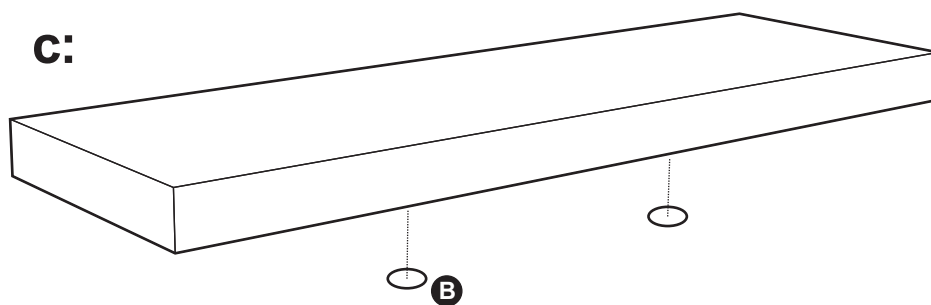

Assembly is complete.

If you need help or have damaged or missing parts, call the **Customer Helpline : 08456 400800**

A Guide to - Wall Mounting & Fixings

Important note:

If plastic wall plugs are supplied with your product:



- these are only suitable for use in masonry walls.

If you are in any doubt about the correct wall plugs for your wall, seek professional advice.

Failure of the product due to using incorrect fixings is the responsibility of the installer.



Important: When drilling into walls always check that there are no hidden wires or pipes etc.

Make sure that the screws and wall plugs being used are suitable for supporting your unit. Consult a qualified tradesperson if you are unsure.

Hints:

- 1: General rule:**  Always use a larger screw and wall plug if you are not sure.
- 2:** Ensure you use the recommended drill bit to match the wall plug and hole size.
- 3:** Ensure you drill the hole horizontally, do not force the drill or enlarge the hole.
- 4:** Take extra care when drilling high walls, ceilings and ceramic tiles. Ensure wall plugs are inserted beyond the thickness of the ceramic tiles to avoid the tiles splitting or cracking.
- 5:** Ensure wall plugs are well fitted and are a tight fit in the drilled hole.

Types of walls

You can use one of the following types of wall plug if your walls are made of brick, breeze block, concrete, stone or wood.

No.1 "General Purpose" wall plug

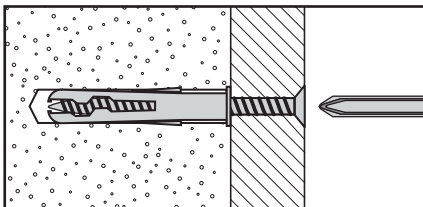

Generally aerated blocks should not be used to support heavy loads, use a specialist fitting in this case. For light loads, general purpose wall plugs can be used.

No.2 "Plasterboard" wall plug

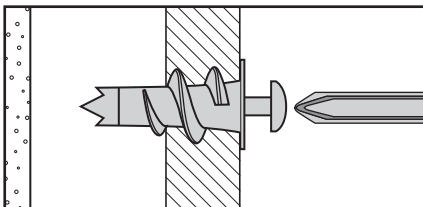

For use when attaching light loads on to plasterboard partitions.

No.3 "Cavity Fixing" wall plug

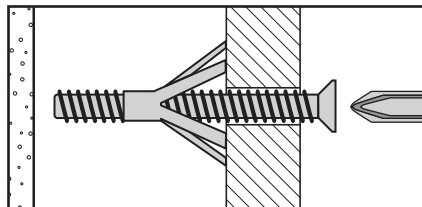

For use with plasterboard partitions or hollow wooden doors.

No.4 "Cavity Fixing-Heavy Duty" wall plug

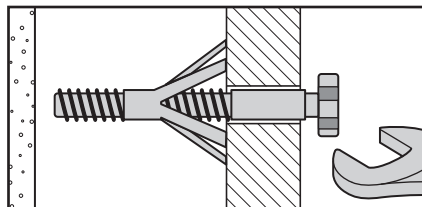

For use when fitting or supporting heavy loads such as shelving, wall cabinets and coat racks.

No.5 "Hammer Fixing" wall plug

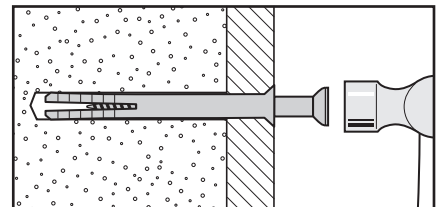

For use with walls stuck with plasterboard. The hammer fixing allows it to be fixed to the wall rather than the plasterboard. Always check the fixing is secure to the retaining wall.

No.6 "Shield Anchor" wall plug Heavy loads

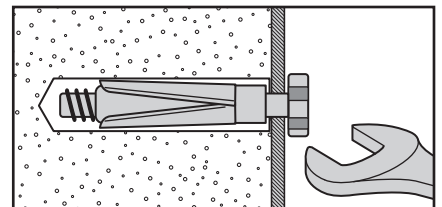

For use with heavier loads such as TV & HiFi speakers and satellite dishes etc.



Care & Maintenance

Safety: Always check the fitting and location to ensure your safety in and around the home.

Fitting: From time to time check the fitting to ensure the wall plugs or screws do not become loose.