

Panasonic[®]

Operating Instructions

Digital Cordless Phone

Model No. **KX-TGB610E**
KX-TGB612E
KX-TGB613E

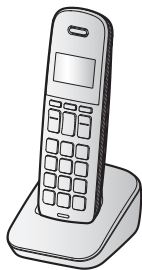

Model shown is KX-TGB610.

***Before initial use, see “Getting Started”
on page 10.***

Thank you for purchasing a Panasonic product.

Please read these operating instructions before using the unit and save them for future reference.

Table of Contents

Introduction

Model composition	3
Accessory information	3
General information	4
Graphical symbols for use on equipment and their descriptions	5

Important Information

For your safety	6
Important safety instructions	7
For best performance	7
Other information	8
Specifications	9

Getting Started

Setting up	10
Controls	12
Display icons	13
Turning the power on/off	13
Language setting	13
Date and time	13

Making/Answering Calls

Making calls	14
Answering calls	14
Useful features during a call	14
Intercom	16

Nuisance call block

Nuisance call block	17
Storing unwanted callers	17

Phonebook

Phonebook	19
-----------------	----

Programming

Menu list	21
Alarm	23

Caller ID Service

Using Caller ID service	24
Caller list	24

Useful Information

Voicemail service	26
Character entry	26
Error messages	28
Troubleshooting	28
Wall mounting	32

Conditions of guarantee	33
-------------------------------	----

Index

Index.....	34
------------	----

Model composition

Series	Model No.	Base unit	Handset	
		Part No.	Part No.	Quantity
KX-TGB610 series	KX-TGB610	KX-TGB610	KX-TGBA61	1
	KX-TGB612	KX-TGB610	KX-TGBA61	2
	KX-TGB613	KX-TGB610	KX-TGBA61	3

Accessory information

Supplied accessories

No.	Accessory item/Part number	Quantity		
		KX-TGB610	KX-TGB612	KX-TGB613
①	AC adaptor/PNLV226E0Q	1	2	3
②	Telephone line cord/PNJA1191Z (for U.K.)	1	1	1
③	Rechargeable batteries*1	2	4	6
④	Handset cover*2	1	2	3
⑤	Charger/PNLC1092ZB	–	1	2

*1 See page 3 for replacement battery information.

*2 The handset cover comes attached to the handset.

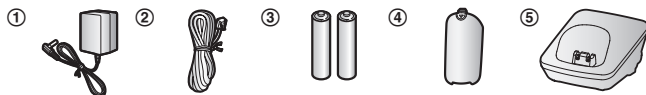

Additional/replacement accessories

Please contact your nearest Panasonic dealer for sales information.

Accessory item	Model number/Specifications
Rechargeable batteries	Battery type: – Nickel metal hydride (Ni-MH) – 2 x AAA (R03) size for each handset – 1.2 V

Other information

- Design and specifications are subject to change without notice.
- The illustrations in these instructions may vary slightly from the actual product.

Sales and support information

Customer Communications Centre

- For customers within the U.K.: 0344 844 3899
- For customers within Ireland: 01289 8333
- For further support on your product, please visit our website: www.panasonic.co.uk

Direct Sales at Panasonic U.K.

- Order accessory and consumable items for your product with ease and confidence by phoning our Customer Communications Centre Monday - Friday 9:00am - 5:00pm (Excluding public holidays).
- Go on line through our Internet Accessory ordering application at www.pas-europe.com
- Most major credit and debit cards accepted.
- All enquiries transactions and distribution facilities are provided directly by Panasonic U.K.
- Also available through our Internet is direct shopping for a wide range of finished products. Take a browse on our website for further details.
shop.panasonic.co.uk/

General information

- This equipment is designed for use on the U.K. and Ireland analogue telephone network.
- In the event of problems, you should contact your equipment supplier in the first instance.

Declaration of Conformity:

- Panasonic Corporation declares that the radio equipment type (KX-TGB610 series: page 3) is in compliance with Directive 2014/53/EU. The full text of the EU declaration of conformity is available at the following internet address:
<https://www.ptc.panasonic.eu/compliance-documents>

Contact to Authorised Representative:

Panasonic Testing Centre
Panasonic Marketing Europe GmbH
Winsbergring 15, 22525 Hamburg, Germany

Ecodesign information

Ecodesign information under EU Regulation (EC) No. 1275/2008 amended by (EU) Regulation No. 801/2013.













"ErP Free Web Product Information" is available at the following URL:
<https://www.ptc.panasonic.eu/compliance-documents>

Power consumption in networked standby and guidance are mentioned in the web site above.

Note:

- For more information about the energy efficiency of the product, please visit our web site, www.panasonic.com, and enter the model number in the search box.

Graphical symbols for use on equipment and their descriptions

Symbol	Explanation	Symbol	Explanation
	Alternating current (A.C.)		Class II equipment (equipment in which protection against electric shock relies on Double Insulation or Reinforced Insulation)
	Direct current (D.C.)		"ON" (power)
	Protective earth		"OFF" (power)
	Protective bonding earth		Stand-by (power)
	Functional earth		"ON"/"OFF" (power; push-push)
	For indoor use only		Caution, risk of electric shock

For your future reference

We recommend keeping a record of the following information to assist with any repair under warranty.

Serial No.	Date of purchase
(found on the bottom of the base unit)	
Name and address of dealer	

For your safety

To prevent severe injury and loss of life/property, read this section carefully before using the product to ensure proper and safe operation of your product.

WARNING

Power connection

- Use only the power source marked on the product.
- Do not overload power outlets and extension cords. This can result in the risk of fire or electric shock.
- Completely insert the AC adaptor/power plug into the power outlet. Failure to do so may cause electric shock and/or excessive heat resulting in a fire.
- Regularly remove any dust, etc. from the AC adaptor/power plug by pulling it from the power outlet, then wiping with a dry cloth. Accumulated dust may cause an insulation defect from moisture, etc. resulting in a fire.
- Unplug the product from power outlets if it emits smoke, an abnormal smell, or makes an unusual noise. These conditions can cause fire or electric shock. Confirm that smoke has stopped emitting and contact an authorised service centre.
- Unplug from power outlets and never touch the inside of the product if its casing has been broken open.
- Never touch the plug with wet hands. Danger of electric shock exists.

Installation

- To prevent the risk of fire or electrical shock, do not expose the product to rain or any type of moisture.
- Do not place or use this product near automatically controlled devices such as automatic doors and fire alarms. Radio waves emitted from this product may cause such devices to malfunction resulting in an accident.

- Do not allow the AC adaptor or telephone line cord to be excessively pulled, bent or placed under heavy objects.

Operating safeguards

- Unplug the product from power outlets before cleaning. Do not use liquid or aerosol cleaners.
- Do not disassemble the product.
- Do not spill liquids (detergents, cleansers, etc.) onto the telephone line cord plug, or allow it to become wet at all. This may cause a fire. If the telephone line cord plug becomes wet, immediately pull it from the telephone wall jack, and do not use.

Medical

- Consult the manufacturer of any personal medical devices, such as pacemakers or hearing aids, to determine if they are adequately shielded from external RF (radio frequency) energy. (The product operates in the frequency range of 1.88 GHz to 1.90 GHz, and the RF transmission power is 250 mW (max..))
- Do not use the product in health care facilities if any regulations posted in the area instruct you not to do so. Hospitals or health care facilities may be using equipment that could be sensitive to external RF energy.

CAUTION

Installation and location

- Never install telephone wiring during an electrical storm.
- Never install telephone line jacks in wet locations unless the jack is specifically designed for wet locations.
- Never touch uninsulated telephone wires or terminals unless the telephone line has been disconnected at the network interface.
- Use caution when installing or modifying telephone lines.
- The AC adaptor is used as the main disconnect device. Ensure that the AC outlet is installed near the product and is easily accessible.

- This product is unable to make calls when:
 - the handset batteries need recharging or have failed.
 - there is a power failure.

Battery

- We recommend using the batteries noted on page 3. **USE ONLY rechargeable Ni-MH batteries AAA (R03) size.**
- Do not mix old and new batteries.
- Do not open or mutilate the batteries. Released electrolyte from the batteries is corrosive and may cause burns or injury to the eyes or skin. The electrolyte is toxic and may be harmful if swallowed.
- Exercise care when handling the batteries. Do not allow conductive materials such as rings, bracelets, or keys to touch the batteries, otherwise a short circuit may cause the batteries and/or the conductive material to overheat and cause burns.
- Charge the batteries provided with or identified for use with this product only, in accordance with the instructions and limitations specified in this manual.
- Only use a compatible base unit (or charger) to charge the batteries. Do not tamper with the base unit (or charger). Failure to follow these instructions may cause the batteries to swell or explode.

Important safety instructions

When using your product, basic safety precautions should always be followed to reduce the risk of fire, electric shock, and injury to persons, including the following:

1. Do not use this product near water for example, near a bathtub, washbowl, kitchen sink, or laundry tub, in a wet basement or near a swimming pool.
2. Avoid using a telephone (other than a cordless type) during an electrical storm. There may be a remote risk of electric shock from lightning.
3. Do not use the telephone to report a gas leak in the vicinity of the leak.

4. Use only the power cord and batteries indicated in this manual. Do not dispose of batteries in a fire. They may explode. Check with local codes for possible special disposal instructions.

SAVE THESE INSTRUCTIONS

For best performance

Base unit location/avoiding noise

The base unit and other compatible Panasonic units use radio waves to communicate with each other.

- For maximum coverage and noise-free communications, place your base unit:
 - at a convenient, high, and central location with no obstructions between the handset and base unit in an indoor environment.
 - away from electronic appliances such as TVs, radios, personal computers, wireless devices, or other phones.
 - facing away from radio frequency transmitters, such as external antennas of mobile phone cell stations. (Avoid putting the base unit on a bay window or near a window.)
- Coverage and voice quality depends on the local environmental conditions.
- If the reception for a base unit location is not satisfactory, move the base unit to another location for better reception.

Environment

- Keep the product away from electrical noise generating devices, such as fluorescent lamps and motors.
- The product should be kept free from excessive smoke, dust, high temperature, and vibration.
- The product should not be exposed to direct sunlight.
- Do not place heavy objects on top of the product.
- When you leave the product unused for a long period of time, unplug the product from the power outlet.
- The product should be kept away from heat sources such as heating devices, cooking

Important Information

appliances, etc. It should not be placed in rooms where the temperature is less than 0 °C or greater than 40 °C. Damp basements should also be avoided.

- The maximum calling distance may be shortened when the product is used in the following places: Near obstacles such as hills, tunnels, underground, near metal objects such as wire fences, etc.
- Operating the product near electrical appliances may cause interference. Move away from the electrical appliances.

Routine care

- **Wipe the outer surface of the product with a soft moist cloth.**
- Do not use benzine, thinner, or any abrasive powder.

Other information

CAUTION: Risk of explosion if battery is replaced by an incorrect type. Dispose of used batteries according to the instructions.

Notice for product disposal, transfer, or return

- This product can store your private/confidential information. To protect your privacy/confidentiality, we recommend that you erase information such as phonebook or caller list entries from the memory before you dispose of, transfer, or return the product.

Disposal of Old Equipment and Batteries (Only for European Union and countries with recycling systems)

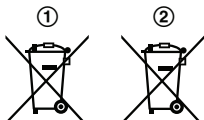

These symbols (①, ②) on the products, packaging, and/or accompanying documents mean that used electrical and electronic products and batteries must not be mixed with general household waste. For proper treatment, recovery and recycling of old products and used batteries, please take them to applicable collection points in accordance with your national legislation.

By disposing of them correctly, you will help to save valuable resources and prevent any potential negative effects on human health and the environment.

For more information about collection and recycling, please contact your local authority. Penalties may be applicable for incorrect disposal of this waste, in accordance with national legislation.

For business users in the European Union

If you wish to discard electrical and electronic equipment, please contact your dealer or supplier for further information.

Information on Disposal in other Countries outside the European Union

These symbols (①, ②) are only valid in the European Union. If you wish to discard these items, please contact your local authorities or dealer and ask for the correct method of disposal.

Note for the battery symbol

This symbol (②) might be used in combination with a chemical symbol. In this case it complies with the requirement set by the Directive for the chemical involved.

Note for the battery removal procedure

Refer to "Removing the battery" on page 11.

Specifications

- **Standard:**
DECT (Digital Enhanced Cordless Telecommunications),
GAP (Generic Access Profile)
- **Frequency range:**
1.88 GHz to 1.90 GHz
- **RF transmission power:**
Approx. 10 mW (average power per channel)
250 mW (max.)
- **Power source:**
100–240 V AC, 50/60 Hz
- **Rechargeable battery:**
AAA (R03) Ni-MH battery (1.2 V, 550 mAh)
- **Power consumption:**
Base unit:
Standby: 0.6 W
Maximum: 1.5 W
Charger:
Standby: 0.1 W
Maximum: 1.0 W
- **Operating conditions:**
0 °C–40 °C, 20 %–80 % relative air humidity (dry)

Setting up

Connections

■ Base unit

- 1 Connect the AC adaptor to the unit by pressing the plug firmly.
- 2 Fasten the cord by hooking it.
- 3 Connect the AC adaptor to the power outlet.
- 4 Connect the telephone line cord to the unit until you hear a click.
- 5 Fasten the cord by hooking it.
- 6 Connect the telephone line cord to the telephone line jack until you hear a click.
- 7 A DSL/ADSL filter (not supplied) is required if you have a DSL/ADSL service.

Note:

- Use only the supplied Panasonic AC adaptor PNLV226E.
- Use only the supplied telephone line cord.

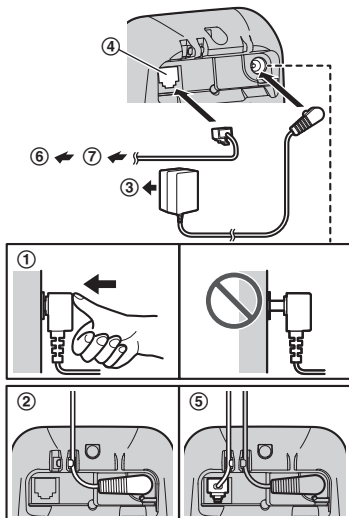

■ Charger

- 1 Connect the AC adaptor plug to the unit until you hear a click.
- 2 Fasten the cord by hooking it.
- 3 Connect the AC adaptor to the power outlet.

Note:

- Use only the supplied Panasonic AC adaptor PNLV226E.

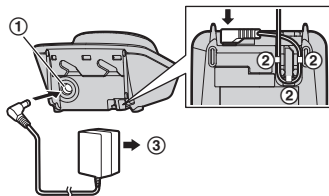

Battery installation

- USE ONLY rechargeable Ni-MH batteries AAA (R03) size (A).
- Do NOT use alkaline/manganese/Ni-Cd batteries.
- Confirm correct polarities (+, -).

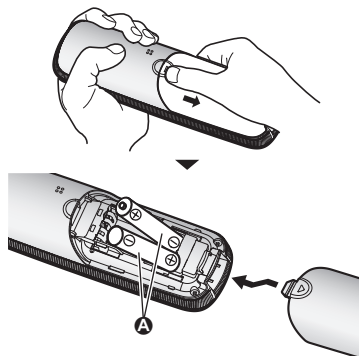

Removing the battery

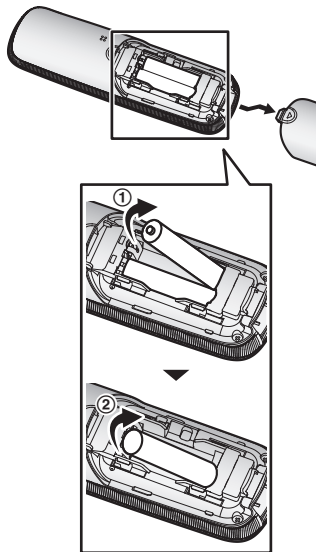

Battery charging

Charge for about 7 hours.

- Confirm is flashing (A).
- When the batteries are fully charged, stops flashing.

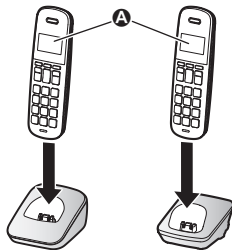

Note when setting up

Note for connections

- The AC adaptor must remain connected at all times. (It is normal for the adaptor to feel warm during use.)
- The AC adaptor should be connected to a vertically oriented or floor-mounted AC outlet. Do not connect the AC adaptor to a horizontally oriented AC outlet that faces the floor, such as an AC outlet installed on a ceiling or under a table, as the weight of the adaptor may cause it to become disconnected.

Power failure

- The unit cannot be used to make or receive calls during a power failure. We recommend connecting a corded-type telephone that does not use an AC adaptor to your telephone line.

Note for battery installation

- Use the supplied rechargeable batteries. For replacement, we recommend using the Panasonic rechargeable batteries noted on page 3, 7.

Note for battery charging

- It is normal for the handset to feel warm during charging.
- Clean the charge contacts of the handset, base unit, and charger with a soft and dry cloth once a month. Before cleaning the unit, disconnect from power outlets and any telephone line cords. Clean more often if the unit is exposed to grease, dust, or high humidity.

Battery level

Icon	Battery level
	High
	Medium
	Low
	Needs charging.

Getting Started

Ni-MH battery performance (supplied batteries)

Operation	Operating time
In continuous use	18 hours max.
Not in use (standby)	200 hours max.

Note:

- Actual battery performance depends on usage and ambient environment.

Controls

Handset

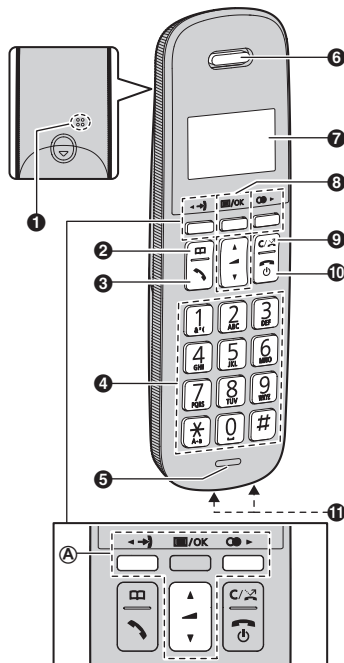

- 1 Ringer
- 2 [☎] (Phonebook)
- 3 [☎] (Talk)
- 4 Dial keypad
- 5 Microphone
- 6 Receiver
- 7 Display
- 8 [☰/OK] (Menu/OK)
- 9 [C/☒] (Clear/Call block)
 - You can return to the previous screen or outside call by pressing [C/☒].

- 10 [⏻] (Off/Power)

- 11 Charge contacts

Control type

A Navigator key

Navigator keys function as follows.

- [▲], [▼], [◀], or [▶]: Scroll through various lists and items.
- [▲] or [▼] (◀▶): Adjust the receiver volume while talking.
- [◀] (→): Caller list: View the caller list.
- [▶] (●): Redial: View the redial list.

Base unit

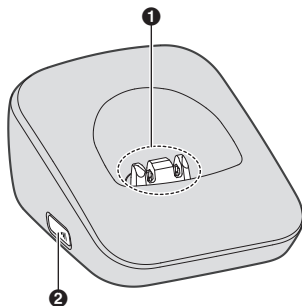









- 1 Charge contacts

- 2 [📍] (Locator)

- You can locate a misplaced handset by pressing [📍].

Display icons

Handset display items

Item	Meaning
	Within range of the base unit <ul style="list-style-type: none"> When flashing: Handset is searching for the base unit. (page 30)
	The line is in use. <ul style="list-style-type: none"> When flashing slowly: The call is on hold. When flashing rapidly: An incoming call is now being received.
	<ul style="list-style-type: none"> Missed call*¹ (page 24) When flashing: Call waiting is being received.
	<ul style="list-style-type: none"> Ringer volume is off. (page 14) When flashing: The call is on mute.
	Battery level
	Privacy mode is on.* ² (page 22)
	Phonebook is opened.
	Nuisance call blocked.* ¹ (page 24)
	New voicemail message received.* ³ (page 26)
Line in use	Someone is using the line.* ²

*1 Caller ID subscribers only

*2 KX-TGB612/KX-TGB613

*3 Voicemail subscribers only

Turning the power on/off





Press  for about 2 seconds.

Language setting

Display language

- #1110
- : Select your desired language. →  → 

Date and time

- #1101
- Enter the current date, month, and year.
→ 
Example: 12 July, 2020
1 2 0 7 2 0
- Enter the current hour and minute.
Example: 15:30
1 5 3 0
-  → 

Making calls

- 1 Lift the handset and then dial the phone number.
 - To correct a digit, press [C/↩].
- 2 Press [📞] to make the call.
- 3 When you finish talking, press [📞] or place the handset on the base unit or charger.

Adjusting the receiver volume

Press [▲] or [▼] repeatedly while talking.

Note:

- If the receiver volume is set to level 5 (max.), it will be changed to level 4 in the next call.

Making a call using the redial list

The last 10 phone numbers dialled are stored in the redial list (24 digits max. each).

- 1 [▶] (●)
- 2 [↕]: Select the desired entry.
- 3 [📞]

Erasing a number in the redial list

- 1 [▶] (●)
- 2 [↕]: Select the desired entry. → [C/↩]
- 3 [☒/OK] → [📞]

Pause (for PBX/long distance service users)

A pause is sometimes required when making calls using a PBX or long distance service. When storing a calling card access number and/or PIN in the phonebook, a pause is also needed (page 20).

Example: If you need to dial the line access number "0" when making outside calls with a PBX:

- 1 [0] → [▲] (Pause)
- 2 Dial the phone number. → [📞]

Note:

- A 3 second pause is inserted each time [▲] (Pause) is pressed.

Answering calls

- 1 Lift the handset and press [📞] when the unit rings.
- 2 When you finish talking, press [📞] or place the handset on the base unit or charger.

Any key answer: You can answer the call by pressing any dial key.

Auto talk: You can answer calls simply by lifting the handset (page 22).

Adjusting the ringer volume

Press [▲] or [▼] repeatedly to select the desired volume while ringing.

- To turn the ringer off, press [▼] repeatedly.

Useful features during a call

Hold

- 1 Press [☒/OK] during an outside call.
- 2 [↕]: "Hold" → [☒/OK]
- 3 To release hold, press [📞].

Note:

- After holding for 10 minutes, the call is disconnected.

Mute

- 1 Press [☒/OK] during a call. → [↕]: "Mute On/Off" → [☒/OK]
 - "☒" flashes.
- 2 To return to the call, press [☒/OK] → [↕]: "Mute On/Off" → [☒/OK].

Recall/flash

Recall/flash allows you to use the special features of your host PBX such as transferring an extension call, or accessing optional telephone services.

- 1 Press **[☒/OK]** during an outside call.
→ **[↕]**: "Recall/Flash" → **[☒/OK]**
- 2 Proceed with the procedure for the desired service.

Note:

- When storing a number in the phonebook or while dialling a number, press **[▼]** (Recall) as necessary (page 19).
- To change the recall/flash time, see page 22.

For call waiting or Call Waiting Caller ID service users

To use call waiting or Call Waiting Caller ID, you must first subscribe with your phone service provider.

This feature allows you to receive calls while you are already talking on the phone. If you receive a call while on the phone, you will hear a call waiting tone.

If you subscribe to both Caller ID and Call Waiting with Caller ID services, the 2nd caller's information is displayed on the unit that is in use after you hear the call waiting tone.

- 1 To answer the 2nd call, press **[☒/OK]**
→ **[↕]**: "Recall/Flash" → **[☒/OK]**
- 2 To switch between calls, press **[☒/OK]**
→ **[↕]**: "Recall/Flash" → **[☒/OK]**

Note:

- Please contact your phone service provider for details and availability of this service in your area.

Call share

Available for:
KX-TGB612/KX-TGB613

You can join an existing outside call.

To join the conversation, press **[☒]** when the other handset is on an outside call.

Note:

- To prevent other users from joining your conversations with outside callers, turn the privacy mode on (page 22).

Transferring calls, conference calls

Available for:
KX-TGB612/KX-TGB613

Outside calls can be transferred or a conference call with an outside party can be made between handsets.

- 1 During an outside call, press **[☒/OK]**.
- 2 **[↕]**: "Intercom" → **[☒/OK]**
- 3 **[↕]**: Select the desired unit. → **[☒/OK]**
- 4 Wait for the paged party to answer.
 - If the paged party does not answer, press **[C/↶]** to return to the outside call.
- 5 **To complete the transfer:**
Press **[☒]**.
To establish a conference call:
[☒/OK] → **[↕]**: "Conference" → **[☒/OK]**
 - To leave the conference, press **[☒]**.
The other 2 parties can continue the conversation.
 - To put the outside call on hold:
[☒/OK] → **[↕]**: "Hold" → **[☒/OK]**
To resume the conference: **[☒/OK]**
→ **[↕]**: "Conference" → **[☒/OK]**
 - To cancel the conference: **[☒/OK]**
→ **[↕]**: "StopConfCall" → **[☒/OK]**
You can continue the conversation with the outside caller.

Intercom

Available for:
KX-TGB612/KX-TGB613

Intercom calls can be made between handsets.

Note:

- When paging the handset, the paged handset beeps for 1 minute.
- If you receive an outside call while talking on the intercom, the interrupt tone sounds. To finish intercom, press [📞]. To answer the call, press [📞].

Making an intercom call

- 1 [📞/OK]
- 2 [↕]: “Intercom” → [📞/OK]
- 3 **To page all handsets:**
Press [📞/OK] again or press [✖].
To select the desired unit:
[↕]: Select the desired unit. → [📞/OK]
- 4 When you finish talking, press [📞].

Answering an intercom call

- 1 Press [📞] to answer the page.
- 2 When you finish talking, press [📞].

Nuisance call block

You can press the **[C/📞]** key in the following situations to disconnect the current call and add a phone number to the call block list:

- when an incoming call is being received
- when talking on an outside call

Once a phone number has been added to the call block list, the unit will block calls from that phone number in the future.

- 1 Press **[C/📞]** under the situations shown above. → **[📞/OK]**
 - The call block number is stored in the call block list, “Call Blocked” is displayed, and then the call is disconnected.

Note:

- If the call has no phone number, the call is blocked but it is not stored in the call block list.
- The call block feature is not available for intercom calls or calls received by call waiting.
- Blocked calls are logged in the caller list.

Storing unwanted callers

The unit can block calls by storing the desired items in the call block list beforehand (Caller ID subscribers only).

- “**Single No.**” : The unit blocks calls from specific phone numbers stored in the call block list.
- “**Range of No.**” : The unit blocks calls that begin with a number stored in the call block list, such as a toll-free phone number prefix or certain area codes.
- “**Withheld**” : The unit blocks calls that have no phone number.

However, this option may not be available in the following situations:

- If the caller dials from an area which does not provide a Caller ID service.
- International calls.

Single phone numbers and ranges of numbers can be stored in the call block list up to 50 items in total.

Blocking unwanted callers:

When a call is received, the unit does not ring while the caller is being identified.

If the caller's phone number matches an entry in the call block list, the unit emits no sound to the caller, and disconnects the call.

Storing a single phone number

Important:

- You must include the area code when storing phone numbers in the call block list.

Adding call blocked numbers from the caller list

- 1 **[←] (→)**
- 2 **[↕]**: Select the desired entry to be blocked.
- 3 **[📞/OK]** → **[↕]**: “Save BLKlist” → **[📞/OK]** 2 times → **[📞]**

Adding call blocked numbers manually

- 1 **[C/📞]**
- 2 **[↕]**: “Single No.” → **[📞/OK]**
- 3 **[📞/OK]** → **[↕]**: “Add” → **[📞/OK]**
- 4 Enter the phone number (24 digits max.). → **[📞/OK]** → **[📞]**

Storing a range of numbers

- 1 **[C/📞]**
- 2 **[↕]**: “Range of No.” → **[📞/OK]**
- 3 **[📞/OK]** → **[↕]**: “Add” → **[📞/OK]**
- 4 Enter the desired number (2-8 digits). → **[📞/OK]** → **[📞]**

Blocking incoming calls that have no phone number

You can block calls when no phone number is provided, such as private callers.

- 1 **[C/📞]**

Nuisance call block

- 2 [↕]: "Withheld" → [☒/OK]
- 3 [↕]: Select the desired setting. →
[☒/OK] → [📞]

Viewing/editing/erasing call block numbers

- 1 [C/↵]
- 2 [↕]: "Single No." or "Range of No." → [☒/OK]
- 3 [↕]: Select the desired entry.
 - After viewing, press [📞] to exit.
- 4 **To edit a number:**
[☒/OK] → [↕]: "Edit" → [☒/OK]
→ Edit the number. → [☒/OK] →
[📞]
To erase a number:
[☒/OK] → [↕]: "Erase" →
[☒/OK] 2 times → [📞]

Note:

- When editing, press the desired dial key to add digits and press [C/↵] to erase digits.

Erasing all call block numbers

- 1 [C/↵]
- 2 [↕]: "Single No." or "Range of No." → [☒/OK]
- 3 [☒/OK] → [↕]: "Erase All" →
[☒/OK] 3 times → [📞]

Phonebook

You can add 50 names (16 characters max.) and phone numbers (24 digits max.) to the phonebook.

Important:

- All entries can be shared by any registered handset.

Adding phonebook entries

- 1 [] → []/OK
- 2 [↕]: “New Entry” → []/OK
- 3 Enter the party's name. → []/OK
 - You can change the character entry mode (page 26) by pressing []
 - [↕]: Select a character entry mode.
 - []/OK
- 4 Enter the party's phone number. → []/OK 2 times
 - To add other entries, repeat from step 3.
- 5 []

Storing a redial list number to the phonebook

- 1 [] ()
- 2 [↕]: Select the desired entry. → []
- 3 To store the name, continue from step 3, “Editing entries”, page 19.

Storing caller information to the phonebook

- 1 [←] (→)
- 2 [↕]: Select the desired entry. → []
- 3 To store the name, continue from step 3, “Editing entries”, page 19.

Finding and calling from a phonebook entry

- 1 []

2 To scroll through all entries

[↕]: Select the desired entry.

To search by first character

- ① Press the dial key (0 to 9, or #) which contains the character you are searching for (page 26).
- ② [↕]: Scroll through the phonebook if necessary.

3 []

Editing entries

- 1 Find the desired entry (page 19). → []/OK
- 2 [↕]: “Edit” → []/OK
- 3 Edit the name if necessary. → []/OK
- 4 Edit the phone number if necessary. → []/OK 2 times
- 5 []

Erasing entries

Erasing an entry

- 1 Find the desired entry (page 19). → []/OK
- 2 [↕]: “Erase” → []/OK 2 times
- 3 []

Erasing all entries

- 1 [] → []/OK
- 2 [↕]: “Erase All” → []/OK 3 times
- 3 []

Chain dial

This feature allows you to dial phone numbers in the phonebook while you are on a call. This feature can be used, for example, to dial a calling card access number or bank account PIN that you have stored in the phonebook, without having to dial manually.

- 1 During an outside call, press [].
- 2 [↕]: Select the desired entry.

3 Press [>] to dial the number.

Note:

- When storing a calling card access number and your PIN in the phonebook as one phonebook entry, press [>] (Pause) to add pauses after the number and PIN as necessary (page 14).

Menu list

To access the features, there are 2 methods.

■ Scrolling through the display menus

- 1 [/OK]
- 2 Press [] or [] to select the desired main menu. → [/OK]
- 3 Press [] or [] to select the desired item from the next sub-menu. → [/OK]
- 4 Press [] or [] to select the desired setting. → [/OK]

■ Using the direct command code

- 1 [/OK] → Enter the desired code.
Example: Press [/OK]#101.
- 2 Select the desired setting. → [/OK]

Note:

- To exit the operation, press [].
- In the following table, < > indicates the default settings.
- In the following table, indicates the reference page number.
- Display menu order and sub-menu may vary depending on your model.

Display the menu tree and direct command code table

Main menu: "Ringer Setup"

Sub-menu 1	Sub-menu 2	Settings	Code	
Ringer Vol. (Vol.: volume)	–	Off-6 <6>	#160	–
Ringtone	–	<Ringtone 1>	#161	–

Main menu: "Time Setting"

Sub-menu 1	Sub-menu 2	Settings	Code	
Date/Time*1	–	–	#101	13
Alarm	–	<Off> Once Daily	#720	23
Time Adjust.*1, *2 (Adjust.: adjustment)	–	<Caller ID> Manual	#226	–

Main menu: "Phonebook"

Operation	Code	
Viewing the phonebook entry.	#280	19

Programming

Main menu: "Caller List"

Operation	Code	
Viewing the caller list.	#213	24

Main menu: "InitialSetup"

Sub-menu 1	Sub-menu 2	Settings	Code	
Call Block ^{*1}	Single No. (No.: number)	–	#217	17
	Range of No.	–		
	Withheld	On <Off>	#240	17
Display	Clock Disp. ^{*3} (Disp.: display)	<On> Off	#198	–
	Contrast (Display contrast)	Level 1–6 <3>	#145	–
Keytones	–	<On> Off	#165	–
Auto Talk ^{*4}	–	On <Off>	#200	14
Line Setup	Recall/Flash ^{*1, *5}	80 msec. 90 msec. <100 msec.> 110 msec. 160 msec. 200 msec. 250 msec. 300 msec. 400 msec. 600 msec. 700 msec. 900 msec.	#121	15
Privacy Mode ^{*1, *6, *7}	–	On <Off>	#194	–
Base PIN ^{*1}	–	<0000>	#132	31
Register HS (HS: handset)	–	–	#130	31
Remove HS ^{*8}	–	–	#131	31
Language	–	<English>	#110	13

Main menu: "Intercom"^{*6}

Operation	Code	
Paging the desired unit.	#274	16

- *1 If you program these settings using one of the handsets, you do not need to program the same item using another handset. (KX-TGB612/KX-TGB613)
- *2 This feature allows the unit to automatically adjust the date and time each time caller information including date and time is received.
To turn this feature on, select “**Caller ID**”. To turn this feature off, select “**Manual**”. (Caller ID subscribers only)
To use this feature, set the date and time first (page 13).
- *3 When this feature is set to off, the handset number is displayed.
- *4 If you subscribe to a Caller ID service and want to view the caller’s information after lifting up the handset to answer a call, turn off this feature.
- *5 The recall/flash time depends on your telephone exchange or host PBX. Contact your PBX supplier if necessary.
- *6 KX-TGB612/KX-TGB613
- *7 To prevent other users from joining your conversations with outside callers, turn this feature on. (KX-TGB612/KX-TGB613)
- *8 This menu is not displayed when scrolling through the display menus. It is only available in direct command code.

Alarm

An alarm sounds at the set time for 1 minute and is repeated 5 times at 5 minute intervals (snooze function). Alarm can be programmed for each handset. You can set one of 2 different alarm options (once, or daily).

Important:

- Make sure the unit’s date and time setting is correct (page 13).

1 **[/OK]** **#** **7** **2** **0**

2 **[]**: Select the desired alarm option. → **[/OK]**

“Off”

Turns alarm off. Go to step 7.

“Once”

An alarm sounds once at the set time.

“Daily”

An alarm sounds daily at the set time.
Go to step 4.

3 Enter the desired date and month. → **[/OK]**

4 Set the desired time. → **[/OK]**

5 **[]**: Select the desired alarm tone. → **[/OK]**

- We recommend selecting a different ringer tone from the one used for outside calls.

6 **[]**: Select the desired snooze setting. → **[/OK]**

7 **[/OK]** → **[]**

Note:

- Press **[]** to stop the alarm completely.
- When the handset is in use, the alarm will not sound until the handset is in standby mode.
- Press any dial key to stop the sound but keep the snooze function activated.
- If you want to make an outside call when the snooze function is activated, please stop the snooze function before making the call.

Using Caller ID service

Important:

- This unit is Caller ID compatible. To use Caller ID features, you must subscribe to a Caller ID service. Contact your phone service provider for details.

Caller ID features

When an outside call is being received, the caller information is displayed.



Caller information for the last 50 callers is logged in the caller list from the most recent call to the oldest.

- If the unit cannot receive caller information, the following is displayed:
 - “Out of Area”/“OUTofAREA”^{*1}: The caller dials from an area which does not provide a Caller ID service.
 - “Private Call”/“Priv. Call”^{*1}: The caller requests not to send caller information.
- If the unit is connected to a PBX system, caller information may not be properly received. Contact your PBX supplier.



^{*1} Shown while viewing the caller list.

Missed calls

If a call is not answered, the unit treats it as a missed call and  is displayed. This lets you know if you should view the caller list to see who called while you were away.

Even if only one missed call in the caller list is viewed (page 24),  disappears from the display. When you receive another new call,  is displayed again.

Note:

- Even when there are unviewed missed calls,  disappears from the standby display if the following operation is performed by one of the registered handsets:
 - Being replaced on the base unit or charger.
 - Pressing [].

Phonebook name display







When caller information is received and it matches a phone number stored in the phonebook, the stored name in the phonebook is displayed and logged in the caller list.

Caller list





Important:

- Make sure the unit's date and time setting is correct (page 13).







Viewing the caller list and calling back

- 1 [] ()
- 2 Press [] to search from the most recent call, or press [] to search from the oldest call.
- 3 To call back, press [].
To exit, press [].

Note:

- If the whole phone number is not shown, press [] to see the remaining phone numbers.
- To switch the display from name or phone number to date and time, press []. To return, press [].
- If the entry has already been viewed or answered, “” is displayed.
 - “!” indicates the caller blocked by Nuisance call block.

Editing a caller's phone number

- 1 [] ()
- 2 []: Select the desired entry. → [/OK]
- 3 []: “Edit & Call” → [/OK]
- 4 Edit the number.
- 5 []

Erasing caller information



- 1 [] ()
- 2 []: Select the desired entry. →
[/OK]
- 3 []: “Erase” or “Erase All” →
[/OK] 2 times
- 4 []

Voicemail service

Voicemail is an answering service that may be offered by your phone service provider. This service can also record calls when you are unavailable to answer the phone or when your line is busy. Messages are recorded on the phone company system.



When you have new messages,  is displayed on the handset if message indication service is available. Please contact your phone service provider for details of this service.

Important:

- If  still remains on the display even after you have listened to new messages, turn it off by pressing and holding **[C/ ** for 2 seconds.

Character entry

The dial keys are used to enter characters and numbers. Each dial key has multiple characters assigned to it. The characters that can be entered depend on the character entry mode (page 26).

- Press **[◀]** or **[▶]** to move the cursor left or right.
- Press dial keys to enter characters and numbers.
- Press **[C/ ** to erase the character or number highlighted by the cursor. Press and hold **[C/ ** to erase all characters or numbers.
- Press **[A→a]** to switch between uppercase and lowercase.
- To enter another character located on the same dial key, press **[▶]** to move the cursor to the next space, then press the appropriate dial key.
- If you do not press any dial key within 2 seconds after entering a character, the character is fixed and the cursor moves to the next space.

Character entry modes

The available character entry modes are Alphabet (ABC), Numeric (0-9), Greek (ΑΒΓ), Extended 1 (ÄÄÄ), Extended 2 (ŠŠŠ), and Cyrillic (АБВ). When in these entry modes except Numeric, you can select which character is entered by pressing a dial key repeatedly.

When the unit displays the character entry screen:

[□□] → [↕]: Select a character entry mode. → **[/OK]**

Note:

-  in the following tables represents a single space.

Alphabet character table (ABC)

0	1	2	3	4	5	6	7	8	9	#
0	& ' () * , - . / 1	A B C 2 a b c 2	D E F 3 d e f 3	G H I 4 g h i 4	J K L 5 j k l 5	M N O 6 m n o 6	P Q R S 7 p q r s 7	T U V 8 t u v 8	W X Y Z 9 w x y z 9	#

Numeric entry table (0-9)

0	1	2	3	4	5	6	7	8	9	#
0	1	2	3	4	5	6	7	8	9	#

Greek character table (ΑΒΓ)

0	1	2	3	4	5	6	7	8	9	#
⌵ 0	& ' () * , - . / 1	Α Β Γ 2	Δ Ε Ζ 3	Η Θ Ι 4	Κ Λ Μ 5	Ν Ξ Ο 6	Π Ρ Σ 7	Τ Υ Φ 8	Χ Ψ Ω 9	#

Extended 1 character table (AĂÄ)

0	1	2	3	4	5	6	7	8	9	#
⌵ 0	& ' () * , - . / 1	A Ä Å Á Ā Ą Â Ã Ä Å Æ B C Ç 2	D Ę Ě É Ê Ë Ĕ ĕ ě Ė F 3	G Ğ H I Ì Í Î Ĵ ĵ ħ 4	J K L 5	M N Ñ O Ò Ó Ô Õ Ö ø 6	P Q R S Ş ß 7	T U Û Ú Ü Û Ü V 8	W Ŵ X Y Ŷ Z 9	#
		a à á â ã ä å æ b c ç 2	d e è é ê ë ĕ ě ě ė f 3	g ğ h i ì í î ĵ ħ ħ 4	j k l 5	m n ñ o ò ó ô õ ö ø 6	p q r s ş ß 7	t u ù ú û ü ü v 8	w ŵ x y ŷ z 9	

- The following are used for both uppercase and lowercase: ø Ş Ŵ Ŷ

Extended 2 character table (SŠŠ)

0	1	2	3	4	5	6	7	8	9	#
⌵ 0	& ' () * , - . / 1	A Á Ą A B C Ć Č 2	D Ę Ě É Ę ě F 3	G H I Í Ĵ 4	J K L Ł Ł Ł 5	M N Ń O Ó Ö Ő 6	P Q R Ŕ Ŗ Š Ś Š 7	T Ŧ U Ú Û Ü ü V 8	W X Y Ŷ Ÿ Z Ž Ž Ž 9	#
		a á ä A b c Ć Č 2	d ě e é Ę ě f 3	g h i Í Ĵ 4	j k l Ł Ł Ł 5	m n Ń ň o ó ö ő 6	p q r Ŕ Ŗ š Ś Š 7	t ŧ u ú û ü ü v 8	w x y ŷ Ÿ z Ž Ž Ž 9	

- The following are used for both uppercase and lowercase:

Ą Ć Č Ę Ł Ł Ł Ń Ŕ Ŗ Š Ÿ Ź Ž Ž

Useful Information

Cyrillic character table (АБВ)

0	1	2	3	4	5	6	7	8	9	#
Л О Г Є І Ї Û	& ' () * , - . / 1	А Б В Г 2	Д Е Ж З 3	И Й К Л 4	М Н О П 5	Р С Т У 6	Ф Х Ц Ч 7	Ш Щ Ъ Ы 8	Ь Э Ю Я 9	#

Error messages

Display message	Cause/solution
Base NoPower or No Link	<ul style="list-style-type: none">• Confirm the base unit's AC adaptor is connected to the unit and the power outlet correctly.• The handset has lost communication with the base unit. Move closer to the base unit and try again.• Unplug the base unit's AC adaptor to reset the unit. Reconnect the adaptor and try again.• The handset's registration may have been cancelled. Re-register the handset (page 31).
Memory Full	<ul style="list-style-type: none">• The phonebook memory is full. Erase unwanted entries (page 19).• The call block list memory is full. Erase unwanted entries (page 18).
Wrong Batt. (Batt.: battery)	<ul style="list-style-type: none">• A wrong type of battery such as alkaline or manganese was inserted. Use only the rechargeable Ni-MH batteries noted on page 3, 7.

Troubleshooting

If you still have difficulties after following the instructions in this section, disconnect the base unit's AC adaptor and turn off the handset, then reconnect the base unit's AC adaptor and turn on the handset.

General use

Problem	Cause/solution
The handset does not turn on even after installing charged batteries.	<ul style="list-style-type: none">• Place the handset on the base unit or charger to turn on the handset.

Problem	Cause/solution
The unit does not work.	<ul style="list-style-type: none"> ● Make sure the batteries are installed correctly (page 10). ● Fully charge the batteries (page 11). ● Check the connections (page 10). ● Unplug the base unit's AC adaptor to reset the unit and turn off the handset. Reconnect the adaptor, turn on the handset and try again. ● The handset has not been registered to the base unit. Register the handset (page 31).
The handset display is blank.	<ul style="list-style-type: none"> ● The handset is not turned on. Turn the power on (page 13).
I cannot hear a dial tone.	<ul style="list-style-type: none"> ● Make sure that you are using the supplied telephone line cord. Your old telephone line cord may have a different wiring configuration. ● The base unit's AC adaptor or telephone line cord is not connected. Check the connections. ● Disconnect the base unit from the telephone line and connect the line to a known working telephone. If the working telephone operates properly, contact our service personnel to have the unit repaired. If the working telephone does not operate properly, contact your phone service provider.
I cannot use the intercom feature.	<ul style="list-style-type: none"> ● This feature is available between the handsets. Although the handset displays "Intercom", this feature is not available for single handset models.

Menu list

Problem	Cause/solution
The display is in a language I cannot read.	<ul style="list-style-type: none"> ● Change the display language (page 13).
I cannot register a handset to a base unit.	<ul style="list-style-type: none"> ● You entered the wrong PIN. If you forget your PIN, see "I cannot remember the PIN." (page 29).
I cannot remember the PIN.	<ul style="list-style-type: none"> ● Change the PIN using the following method. <ol style="list-style-type: none"> 1 [OK] # 1 3 2 2 7 0 0 0 3 Enter the new 4-digit base unit PIN. → [OK] 2 times 4

Battery recharge

Problem	Cause/solution
The handset beeps and/or flashes.	<ul style="list-style-type: none"> ● Battery charge is low. Fully charge the batteries (page 11).

Useful Information

Problem	Cause/solution
I fully charged the batteries, but –  still flashes or – the operating time seems to be shorter.	<ul style="list-style-type: none">● Clean the battery ends (+, -) and the charge contacts with a dry cloth and charge again.● It is time to replace the batteries (page 10).

Making/answering calls, intercom

Problem	Cause/solution
 is flashing.	<ul style="list-style-type: none">● The handset is too far from the base unit. Move closer.● The base unit's AC adaptor is not properly connected. Reconnect AC adaptor to the base unit.● The handset is not registered to the base unit. Register it (page 31).
Noise is heard, sound cuts in and out.	<ul style="list-style-type: none">● You are using the handset or base unit in an area with high electrical interference. Re-position the base unit and use the handset away from sources of interference.● Move closer to the base unit.● If you use a DSL/ADSL service, we recommend connecting a DSL/ADSL filter between the base unit and the telephone line jack. Contact your DSL/ADSL provider for details.
The handset does not ring.	<ul style="list-style-type: none">● The ringer volume is turned off. Adjust ringer volume (page 14, 21).

Caller ID

Problem	Cause/solution
Caller information is not displayed.	<ul style="list-style-type: none">● You must subscribe to a Caller ID service. Contact your phone service provider for details.● If your unit is connected to any additional telephone equipment, remove and plug the unit directly into the wall jack.● If you use a DSL/ADSL service, we recommend connecting a DSL/ADSL filter between the base unit and the telephone line jack. Contact your DSL/ADSL provider for details.● Other telephone equipment may be interfering with this unit. Disconnect the other equipment and try again.
Caller information is slow to display.	<ul style="list-style-type: none">● Depending on your phone service provider, the unit may display the caller's information at the 2nd ring or later.● Move closer to the base unit.
Time on the unit has shifted.	<ul style="list-style-type: none">● Incorrect time information from incoming Caller ID changes the time. Set the time adjustment to "Manual" (off) (page 21).

Liquid damage

Problem	Cause/solution
Liquid or other form of moisture has entered the handset/base unit.	<ul style="list-style-type: none"> Disconnect the AC adaptor and telephone line cord from the base unit. Remove the batteries from the handset and leave to dry for at least 3 days. After the handset/base unit are completely dry, reconnect the AC adaptor and telephone line cord. Insert the batteries and charge fully before use. If the unit does not work properly, contact an authorised service centre.

Caution:

- To avoid permanent damage, do not use a microwave oven to speed up the drying process.

Registering a handset to the base unit

- Handset:**
 [☒/OK] # 1 3 0
- Base unit:**
 Press and hold [●●] for about 5 seconds.
 - If all registered handsets start ringing, press [●●] again to stop, then repeat this step. (KX-TGB612/KX-TGB613)
- Handset:**
 [☒/OK] → Wait until “<Base PIN>” is displayed. → Enter the base unit PIN (default: “0000”). → [☒/OK]
 - If you forget your PIN, see page 29.

Deregistering a handset

- [☒/OK] # 1 3 1
 - All handsets registered to the base unit are displayed.
- [↕]: Select the handset you want to cancel. → [☒/OK] 2 times → [🔌]

Changing the base unit PIN

Important:

- If you change the PIN (Personal Identification Number), please make note of your new PIN. The unit will not reveal the PIN to you. If you forget your PIN, see page 29.
- [☒/OK] # 1 3 2
 - Enter the current 4-digit base unit PIN (default: “0000”).
 - Enter the new 4-digit base unit PIN. → [☒/OK] 2 times → [🔌]

Wall mounting

Note:

- Make sure that the wall and the fixing method are strong enough to support the weight of the unit.
- Drive the screws (not supplied) into the wall (recommended heights ≤ 1.5 m).
 - Ⓐ Screws
 - Ⓑ 25 mm

■ **Charger**

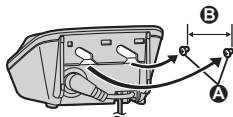

Caution:

- Place the handset properly on the cradle to prevent harm from accidental fall.

Conditions of guarantee

This guarantee is in addition to and does not in any way affect any statutory or other rights of consumer purchasers. If within the applicable guarantee period, the product proves to be defective by reason of faulty design, workmanship or materials, we undertake subject to the following conditions to have the defective product (or any part or parts thereof) repaired or replaced free of charge.

1. The product shall have been purchased and used solely within either the U.K. or Ireland and in accordance with standard operating instructions and the technical and/or Safety Standards required in the U.K.
2. On being found defective, please consult with the retailer from where it was purchased for assistance.
3. This guarantee shall not apply to damage caused through fire, accident, lightning, misuse, wear and tear, neglect, incorrect adjustment or repair, to damage caused through installation, adaption, modification or use in an improper manner or inconsistent with the technical and/or safety standards required in the country where this product is used, or to damage occurred during transit to or from the purchaser.
4. If at any time during the guarantee period any part or parts of the product are replaced with a part or parts not supplied or approved by us or of an objective quality safe and suitable for the product, or the product has been dismantled or repaired by any person not authorised by us, we shall have the right to terminate this guarantee in whole or in part immediately without further notice.
5. The purchaser's sole and exclusive remedy under this guarantee against us is for the repair or replacement of the product or any defective part or parts and no other remedy, including, but not limited to, incidental or consequential damage or loss of whatsoever nature shall be available to the purchaser.
6. This guarantee shall not apply to batteries and any other items of limited natural life.
7. Our decision on all matters relating to complaints shall be final. Any product or defective part which has been replaced shall become our property.
8. The guarantee period applicable to this product shall be 12 months.

Please keep these operating instructions with your receipt.

Panasonic U.K. a branch of Panasonic Marketing Europe GmbH

Receipt No. _____	Date of purchase _____
Model No. _____	Serial No. _____

Index

- A** Alarm: 23
Answering calls: 14
Auto talk: 14, 22
- B** Battery: 10, 11
- C** Call share: 15
Call waiting: 15
Call Waiting Caller ID: 15
Caller ID service: 24
Caller list: 24
Caller list edit: 24
Chain dial: 19
Character entry: 26
Conference calls: 15
Control type: 12
- D** Date and time: 13
Direct command code: 21
Display
 - Clock: 22
 - Contrast: 22
 - Language: 13
- E** Error messages: 28
- H** Handset
 - Deregistration: 31
 - Locator: 12
 - Registration: 31Hold: 14
- I** Intercom: 16
- K** Keytones: 22
- M** Making calls: 14
Missed calls: 24
Mute: 14
- N** Nuisance call block: 17
- P** Pause: 14
Phonebook: 19
PIN: 31
Power failure: 11
Power on/off: 13
Privacy mode: 22
- R** Recall/flash: 15
Redialling: 14
Ringer tone: 21
- T** Transferring calls: 15
Troubleshooting: 28
- V** Voicemail: 26
Volume
 - Receiver: 14

- Ringer (Handset): 14
- W** Wall mounting: 32

IMPORTANT!

If your product is not working properly. . .

- ① **Reconnect AC adaptor to the base unit.**
- ② **Check if telephone line cord is connected.**
- ③ **Use rechargeable Ni-MH batteries.**
(Alkaline/Manganese/Ni-Cd batteries CANNOT be used.)
- ④ **Read troubleshooting page in the Operating Instructions.**



If you still have any problems, please call the Panasonic DECT Helpline

0344 844 3899 (U.K.)

01289 8333 (Ireland)

or contact us through our website:

www.panasonic.co.uk

Sales Department:

Panasonic U.K. a branch of
Panasonic Marketing Europe GmbH

Maxis 2, Western Road, Bracknell, Berkshire, RG12 1RT

Panasonic Corporation

1006, Oaza Kadoma, Kadoma-shi, Osaka 571-8501, Japan
<http://www.panasonic.com>

© Panasonic Corporation 2020

PNQP1549ZA PP0120LC0