

# **DC Dimplex<sup>®</sup>**

**ion**   
*Fresh*

## **USE & CARE INSTRUCTIONS**

**Model: DXIONCF ION FRESH TOWER COOLING FAN**

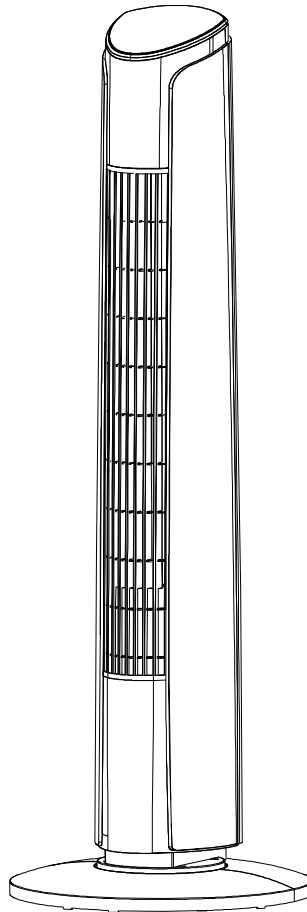

**PLEASE READ THESE INSTRUCTIONS CAREFULLY AND RETAIN FOR FUTURE USE**

A brand of the GDC Group Limited, trading as Glen Dimplex Heating & Ventilation



## IMPORTANT SAFETY WARNINGS



**Failure to comply with the warnings listed below may result in serious injury, risk of fire or electric shock.**

This product should be used only in accordance with the specifications outlined in this manual. Usage other than as specified in these instructions may result in serious injury, risk of fire or electric shock.

- **IMPORTANT** - To reduce the risk of electric shock, the plug is intended to fit in a standard polarized 13Amp socket outlet, only plug the appliance directly into a proper electrical outlet.
- To protect against electrical hazards, **DO NOT** immerse in water or other liquids. Do not use near water or in the vicinity of a bath a shower or a swimming pool.
- Children cannot recognize the hazards associated with the usage of electrical appliances. For this reason, always supervise children when they are near the unit. These appliances can be used by children aged from 3 and above and persons with reduced physical, sensory or mental capabilities or lack of experience and knowledge if they have been given supervision or instruction concerning use of the appliance in a safe way and understand the hazards involved. Children shall not play with the appliance. Cleaning and user maintenance shall not be made by children without supervision.
- Children aged from 3 years and less than 8 years shall only switch on/off the appliance if it has been placed or installed in its intended normal operating position and they have been given supervision or instruction concerning use of the appliance in a safe way and understand the hazards involved. Children aged from 3 years and less than 8 years shall not plug in, regulate and clean the appliance or perform user maintenance.
- Always unplug the tower fan before moving it or cleaning it. Be sure to pull by the plug and not the cord when un-plugging the appliance.
- **NEVER** drop or insert any object into any openings.
- **DO NOT** operate appliance connected to an extension cable
- Keep the cord out of heavy traffic areas. To avoid fire hazard, **NEVER** put the cord near heat registers, radiators, stoves or heaters.
- **DO NOT** cover cord with carpeting, throw rugs, runners, or similar coverings.
- **DO NOT** route cord under furniture or appliances. Take care to position the cord away from traffic areas and where it will not be a trip hazard.
- **DO NOT** operate any appliance with a damaged cord or plug, if motor fan fails to rotate, after the appliance malfunctions, or if it has been dropped or damaged in any manner. Please contact our customer service team.
- Use appliance only for intended household use as described in this manual. Any other use not recommended by the manufacturer may cause fire, electric shock or injury to persons.
- **DO NOT** use outdoors.
- **DO NOT** place anything on top of the appliance.
- **NEVER** block the air openings, grills/outlets or place on a soft surface such as a bed or sofa, as this could cause the unit to tip over, blocking the air intake or outtake opening.
- **DO NOT** attempt to repair or adjust any electrical or mechanical functions on this product. Doing so will void your warranty. The inside of the unit contains no user serviceable parts. Please contact our customer service team.
- **WARNING:** To reduce the risk of fire or electric shock, do not use this fan with any solid-state speed control device.
- **WARNING:** To avoid danger of suffocation please remove all packaging materials particularly plastic and EPS and keep these away from vulnerable people, children and babies.
- **WARNING:** To avoid the risk of accidental strangulation from the supply cord all children and vulnerable people must be supervised when near the product whether it is working or not.
- **WARNING:** Keep batteries out of reach of children, dispose of used button batteries immediately and safely.

## TECHNICAL SPECIFICATION

Specification Details	DXIONCF	Symbol	Value	Unit
Maximum Fan Flow Rate		F	24.45	m <sup>3</sup> /min
Fan Power Input		P	36.52	W
Service Value		SV	0.67	(m <sup>3</sup> /min)/W
Standby Power Consumption		PSB	0.584	W
Fan Sound Power Level		LWA	59	dB(A)
Maximum Air Velocity		c	2.646	meters/sec
Rated Voltage		V	220-240	V
Rated Frequency		Hz	50	Hz
Measurement Standard for Service Value	IEC 60879:1986			

## HOW TO ASSEMBLE THE BASE

The base of the tower fan comes in two parts, which fit around the oscillation base of the tower. The two parts have interlocking holes and bosses which easily slide/fit into each other when aligned. The back half has cable hooks and a cut-out on the edge to allow the power supply cord to exit flush with the bottom of the base.

1. First attach the back half of the base, aligning the holes in the base with the screw holes in the back side of the oscillation base of the tower, feed the power cord under the two hooks and through the hole at the edge.
2. Then align the bosses on the front half of the base with the holes on the back half and slide them together against the bottom of the tower.
3. Secure the base to the bottom of the tower with the four wing head screws supplied, two through the front half and two through the back half.

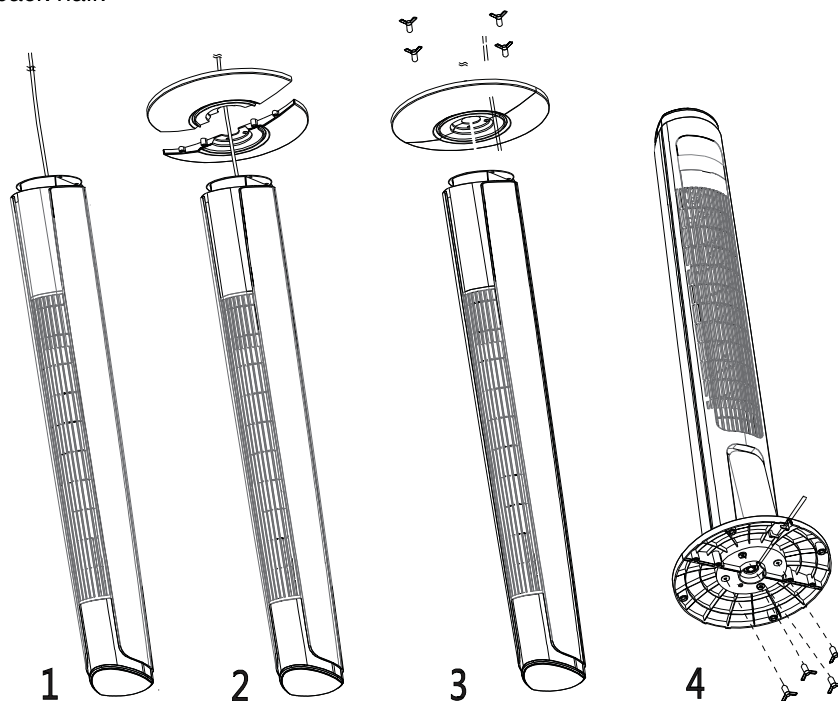

(Figure 1)

4. The product can now be stood upright on its secured base with the cable passing out the rim at the back flush with the standing surface.

## REMOTE CONTROL

Your remote control comes complete with a CR2025 3V battery fitted. Before using please pull out the plastic insulation tab to connect the battery. To replace the battery simply unclip and remove the battery cover on the back and replace the battery, then carefully refit the cover and snap into place.

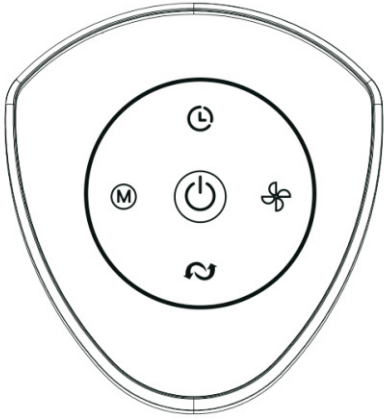



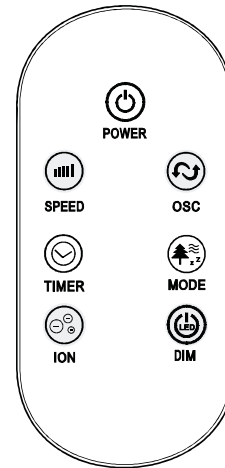



(FIGURE 2)







(FIGURE 3)

## OPERATING INSTRUCTIONS



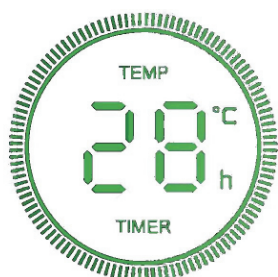

This TOWER FAN can be operated using the manual controls located on the top of the TOWER FAN (as shown in FIGURE 2) or by using your remote control (shown in FIGURE 3) supplied with the product.

1. Place the FAN on a stable flat surface. Plug the cord set into a 220-240V~A.C. electrical outlet. When you Plug in the FAN the current room temperature will be displayed on the display panel.
2. **POWER** : You turn the FAN on by pressing the '**POWER**' button; Turn the FAN off by pressing the '**POWER**' button again.
3. **SPEED** : You can adjust the fan speed to the desired level: low (I), medium (II), or high (III) by pressing the '**SPEED**' button repeatedly until the speed you require is displayed on the LED panel (shown in FIGURE 4).
4. **MODE** : Pressing the '**MODE**' button will change the operation of the FAN between NORMAL, NATURAL, SLEEP and CHILD mode, the symbol for the mode selected will appear on the LED display panel as indicated in the following description;
  - In NORMAL Mode  , the fan will run continuously at whatever fan speed you select (see 3. Speed selection above).
  - In NATURAL Mode  , the fan will run at high speed for 15s, then change down automatically to middle speed for 15s and finally change down to low speed automatically for 15s before cycling back up to high speed and starting the same automatic speed changing cycle of operation again and continuing to run that way until manually switched off.
  - If you select SLEEP Mode  at high speed, the fan will work at high for 30 mins, then automatically change down to medium for 30 mins and then change down to run at low and continue to run that way until manually switched off. If sleep mode is selected at medium it runs for 30 mins at medium then switches down to low speed and continues to run. If selected at low speed it just continues to run at low until switched off. Note that display always turns off after 30s.

- If you select EASY Mode  the fan will start oscillating, the ioniser will switch on and the runback timer will auto-set to 3 hours, the fan will initially run at high speed for 15 minutes, then change down automatically to middle speed for 15 minutes and then automatically change down to low speed, it will continue to run at low speed until manually switched off. You can switch off the oscillation in this mode by pressing the OSC button once.
5. **TIMER** : The fan is equipped with a runback timer that allows you to set its length of operation from 1 hour to 12 hours.
  6. **OSCILLATION** : Pressing the 'OSC' button once will start the oscillation function, the symbol is displayed on the LED panel when it is selected/on, to stop press the OSC button again.
  7. **IONISER** : The Ioniser function is only selectable by pressing the 'ION' button on the remote control, the "ION" symbol is displayed on the LED panel when it is selected/on, to stop the Ioniser function press the 'ION' button again on the remote. The ioniser discharges negative ions in the air that help to combat airborne impurities and help create fresher cleaner air.



**FIGURE 4 – LED Display with Ionizer function**

NB - If the fan speed varies randomly automatically you have selected NATURAL  mode which simulates natural breeze conditions. THIS IS NOT A FAULT. To de-select this operation please press MODE button  until NORMAL mode  is lit and only use the SPEED selection button  to change and select the fan speed you require (Low / Med / High).

8. Display LED – can be switched off temporarily by pressing the DISPLAY button on the remote or by pressing and holding the SPEED button on the control panel for more than 3 seconds, the display will light up again once any control button is activated.
9. **Adjusting the Angle of Air Output.** The Tower Fan can be manually adjusted to change the direction of the air flow, with the Tower vertical the air comes out horizontally, simply apply pressure backwards at the top of the Tower and the angle will change until it reaches its limit at an angle of approximately 7° to the vertical with the air flow now directed upwards from the horizontal. Applying pressure forward to the top of the Tower will readjust it back to its vertical position again. (See FIGURE 5)

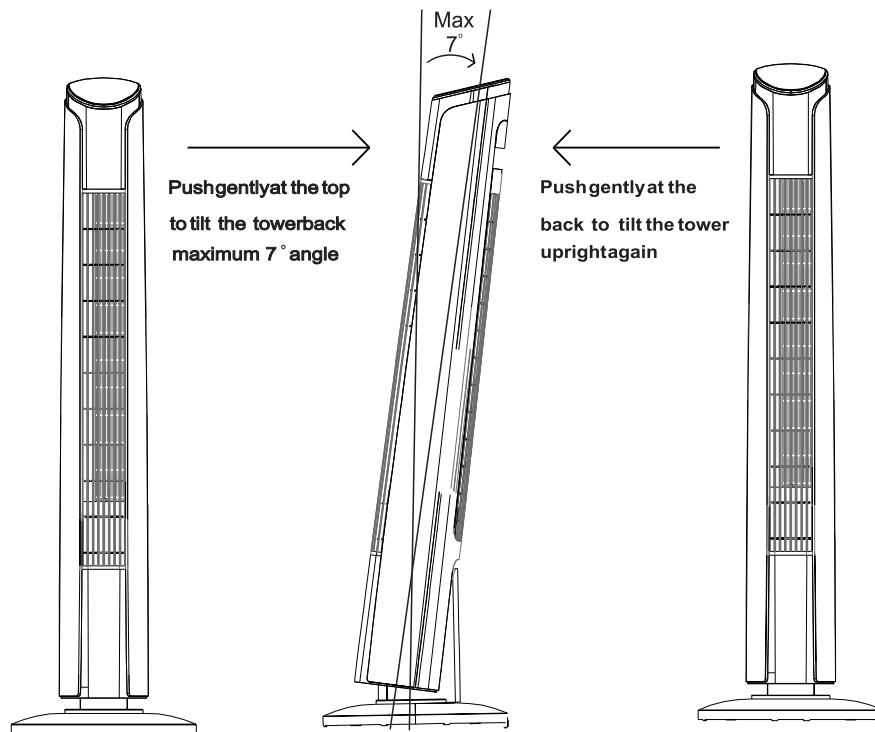

(FIGURE 5)

### **CLEANING :**

Disconnect from the mains before attempting to clean the appliance.

Clean the air inlet and outlet regularly with a soft damp (not wet) cloth as these areas accumulate dust normally during use. Do not use petrol or solvents or caustic or abrasive cleaning agents as these will destroy the surfaces of the heater.



### **RECYCLING – Important - Correct Disposal of this product**

The crossed bin symbol on the appliance indicates that the product, at the end of its life, must be disposed of separately from domestic waste, either by taking it to a separate waste disposal site for electric and electronic appliances or by returning it to your dealer when you buy another similar appliance. The user is responsible for taking the appliance to a special waste disposal site at the end of its life. If the disused appliance is collected correctly as separate waste, it can be recycled, treated and disposed of ecologically; this avoids a negative impact on both the environment and health, and contributes towards the recycling of the product's materials. For further information regarding the waste disposal services available, contact your local waste disposal agency or manufacturer.

Batteries should be disposed of or recycled in accordance with WEEE Directive 2012/19/EU.

Packaging should be recycled where possible.

Dispose of used button batteries immediately and safely through a proper recycling facility.

## Warranty

### What does a Dimplex Warranty cover?

Dimplex products deliver reliable service for normal, household use in domestic settings. All Dimplex products are individually tested before leaving the factory.

If you are a consumer and you experience a problem with your Dimplex product, which is found to be defective due to faulty materials or workmanship within the Warranty Period, this Dimplex Warranty will cover repair or - at the discretion of Dimplex – replacement with a functionally equivalent Dimplex product.

Your product is under warranty for 1 year from the date of purchase or the date of delivery of the product, if later. The 1 year warranty is extended for an additional 2 years when you register the product with Dimplex, within 28 days of purchase. If you do not register the product with Dimplex within 28 days, your product will remain warrantied for 1 year only. To validate your extended warranty register with us online at: <http://register.dimplex.co.uk>. **N.B.** Each qualifying product needs to be registered with Dimplex individually. Please note that the extended warranty is only available in the UK and Ireland. The Dimplex Warranty is conditional upon you providing the original purchase receipt as proof of purchase. Please therefore retain your receipt as proof of purchase.

If you do experience a problem with your Dimplex product please call the Helpline on **+44 [0]344 879 3588** or visit <https://www.dimplex.co.uk/support>.

For **ROI** please email [serviceireland@glendimplex.com](mailto:serviceireland@glendimplex.com) or call **+353(0)1 842 4833**. We will need details of your Dimplex product and a description of the fault which has occurred. Once we receive your information and proof of purchase we will contact you to make the necessary arrangements.

If your Dimplex product is not covered by this Dimplex Warranty there may be a charge to repair your product. However, we will contact you for agreement to any charges before any chargeable service is carried out.

### What is not covered by a Dimplex Warranty?

The Dimplex Warranty does not cover any of the following:

Any fault or damage to your Dimplex product due to faulty materials or workmanship occurring outside the Warranty Period.

Normal wear and tear including parts that might wear out over time or consumables, such as filters.

Any fault or damage occurring to any pre-owned Dimplex product or to any other equipment or property.

Accidental damage to your Dimplex product or damage to your Dimplex product from external sources (for example, transit, weather, electrical outages or power surges).

Fault or damage to your Dimplex product which is:

- Not due to faulty materials or workmanship or which is due to circumstances outside Dimplex's control.
- Caused by use of your Dimplex product for anything other than normal domestic household purposes in the country where it was purchased.
- Caused by any misuse, abuse or negligent use of the Dimplex product, including but not limited to any failure to use it in accordance with the Operating Instructions supplied with the product.
- Caused by any failure to assemble, install clean and maintain your Dimplex product in accordance with the Operating Instructions supplied with the product unless this was carried out by Dimplex or its authorised dealers.
- Caused by repairs or alterations to your Dimplex product not carried out by Dimplex service personnel or its authorised dealer(s).

- Caused by use of any consumables or spare parts for your Dimplex product which are not Dimplex -specified.

## **Terms and Conditions**

The Dimplex Warranty is valid for 1 calendar year, plus 2 if registered, from the date of purchase of your Dimplex product from a recognised retailer in the country of purchase and use, or the date of delivery of the product if later, always provided the original receipt has been retained and is produced as proof of purchase.

You must provide to Dimplex or its authorised agents on request the original receipt as proof of purchase and - if required by Dimplex - proof of delivery. If you are unable to provide this documentation, you will be required to pay for any repair work required.

Any repair work under the Dimplex Warranty will be carried out by Dimplex or its authorised dealer(s) and any parts that are replaced will become the property of Dimplex. Any repairs performed under the Dimplex Warranty will not extend the Warranty Period.

Any replacement of your Dimplex product by Dimplex during the Warranty Period will start the 3 year Warranty Period afresh from the date of delivery of the replacement Dimplex product to you. (\*Please keep original online warranty registration email and sales receipt for your original purchase as proof of the additional 2 years, in case of the unlikely event you experience an issue).

The Dimplex Warranty does not entitle you to recovery of any indirect or consequential loss or damage including but not limited to loss or damage to any other property.

The Dimplex Warranty is in addition to your statutory rights as a consumer and your statutory rights are not affected by this Dimplex Warranty.

## **Contact Dimplex** A brand of the GDC Group Limited, trading as Glen Dimplex Heating & Ventilation

If you have any questions about what the Dimplex Warranty covers and does not cover or how to claim under the Dimplex Warranty, please contact us:

GDHV, Grange Drive,  
Hedge End,  
Southampton SO30 2DF

Telephone: 0344 879 3588

Email: [customer.services@glendimplex.com](mailto:customer.services@glendimplex.com)

Visit: [www.dimplex.co.uk](http://www.dimplex.co.uk)

---

This product complies with EU Directive 2002/96/EC

© Glen Dimplex. All rights reserved. Material contained in this publication may not be reproduced in whole or in part without prior permission in writing of Glen Dimplex.

GDHV Group Ltd reserves the right to modify the content of these instructions, at any time and without prior notice.