

说明书

尺寸: 210*148mm

材质: 80g书纸

颜色: 黑白印刷

用量: 1pc

品号3020300561

BUSH

Instruction manual

Model: CDV-94288

SKU: 134249856





You'll soon be enjoying your new DVD Player .

It all begins here, with your instructions. Don't worry, there's nothing too technical coming up. Just simple, step-by-step guidance to get you up and running quickly. Sound good? Then let's get started.



Help and Guidance

We're here to help you get the most from your DVD Player. Should you require any guidance, a simple solution can often be found online at:

www.bush-support.com

If you still require further assistance, call one of our experts on **0345 600 3021**.

If you require any technical guidance or find that your product is not operating as intended, a simple solution can often be found in the **Troubleshooting** section of these instructions.



Contents

1 Safety information		
General safety information	6	
Power source	6	
Moisture and water	7	
Heat sources and flames	7	
Ventilation	7	
Care and cleaning	7	
2 Getting to know your DVD Player		
Setting up	10	
Your DVD player	11	
Remote control	12	
Making the connections	14	
SCART cable connection to the TV	14	
Installing the remote batteries	14	
Remote control working range	14	
Connecting the mains power	14	
Standby mode	14	
3 Using your DVD Player		
Getting started	18	
Adjust the volume	18	
Mute	18	
Repeat play (DVD/CD/JPG)	18	
Zoom (DVD, Images)	19	
Multi-angle (DVD)	19	
Subtitles (DVD)	19	
Numeric keypad (DVD/CD)	19	
DVD/USB	19	
System setup	20	
4 Other information		
Technical specification	24	
USB Port Supported Media	25	
5 Product support		
Troubleshooting		28
Help and assistance		29
Your Bush Guarantee		31
Important Data Protection Information		31



This page is left intentionally blank



Safety information

1

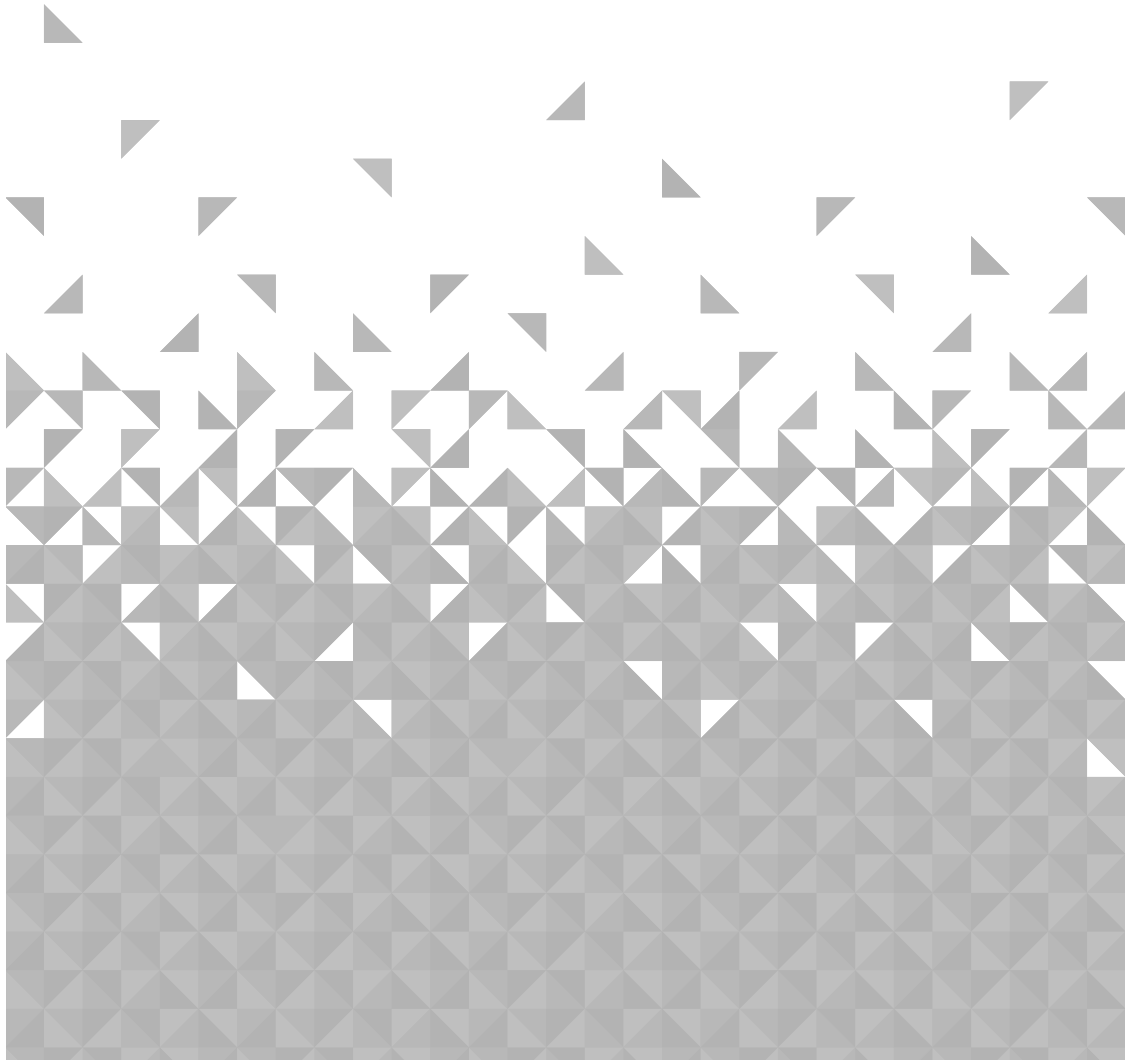



Safety information

Important - Please read these instructions fully before installing or operating

General safety information

- Keep the product and all its parts out of reach of small children.
- This product is not intended for use by persons (including children) with reduced physical, sensory or mental capabilities, or lack of experience and knowledge, unless they have been given supervision or instruction concerning the use of the appliance by a person responsible for their safety.
- Disconnect your DVD Player from the mains power supply during thunderstorms or electrical storms.
- Always check that you have completely switched off your DVD Player, before you change or disconnect the power supply.
- Do **NOT** attempt to open the product. This product does not contain any use
- Do **NOT** place foreign objects into the DVD compartment.
- This product is for Indoor use only.
- In order to avoid electric shock, do not bend, stretch, pinch or pull the power supply cable.
- Disconnect your DVD Player from the mains power supply during thunderstorms.
- Always check that you have completely switched off your DVD Player, before you change or disconnect the power supply.
- Where the mains power plug or an appliance coupler is used as the disconnect device, the disconnect device shall remain readily operable.
- The power socket must be within easy reach.
- Switch the DVD Player off at the mains power socket and unplug it if you are leaving it unattended for a long period of time (holidays etc).
- Do not attempt to open the product. This product does not contain any user serviceable parts. Unauthorised handling of the product may damage it and will void your warranty.



CAUTION

Never touch or look into the optical lens within the DVD compartment.



This is a CLASS-1 laser product.

Use of controls or adjustments other than those specified herein, may result in hazardous laser light beam exposure. Do **NOT** open the cover and do **NOT** attempt to repair it yourself. Refer servicing to qualified personnel. This product does not contain any user serviceable parts. Unauthorised handling of the device may damage it and will void your warranty.



CAUTION

Danger of explosion if batteries are incorrectly replaced. Replace only with the same or equivalent type.



CAUTION

Do not ingest the battery, Chemical Burn Hazard.

Power source

- Only use the power supply that came with the product. Using an unauthorised power supply will invalidate your guarantee and may irreversibly damage the product.
- If you think batteries might have been swallowed or placed inside any part of the body, seek immediate medical attention.
- The remote control supplied with this product contains 2 x AAA batteries. Keep new and used batteries away from children.
- Only use recommended batteries or those of the same or equivalent type. Do not mix old and new batteries or batteries of different types.
- Batteries are to be inserted with the correct polarity.
- The supply terminals are not to be short-circuited.
- Remove the batteries from the remote control if they will not be used for an extended period of time.

If you require any technical guidance or find that your product is not operating as intended, a simple solution can often be found in the **Troubleshooting** section of these instructions.



Safety information

Important - Please read these instructions fully before installing or operating

- Never throw batteries in a fire or attempt to open the outer casing.
- Do not expose batteries to excessive heat, such as sunshine.
- Batteries are harmful if swallowed, so keep away from young children.
- If the battery compartment does not close securely, stop using the product and keep it away from children.

Moisture and water

- To reduce the risk of fire or electric shock, do not use this product near water or moisture.
- Do not use this product near a bath or sink, near a swimming pool or anywhere else that water or moisture is present.
- Do not place objects filled with water, such as a vase, on or near the product.
- Keep it dry. Avoid exposure to precipitation, humidity and liquids which could all affect the product circuitry.

Heat sources and flames

- Do not leave this product in high temperatures as electronic devices and plastic parts may warp in heat.
- Keep it away from bright sunlight or heat sources, such as a radiator.
- Never place any type of candle or naked flame on top of, or near the product.

Ventilation

- Do not install this product in a confined space.
- Allow adequate ventilation to prevent heat build-up.
- Do not block or cover slots, holes or openings on

the product by placing on soft furnishings such as carpets, rugs or beds as these are provided for functionality and/or ventilation to ensure safe operation of the product.

Care and cleaning

- All care and cleaning operations should be carried out with the DVD Player unplugged from the mains power.
- Occasionally wipe the cabinet with a lint free cloth.



This page is left intentionally blank



Getting to know your DVD Player

2

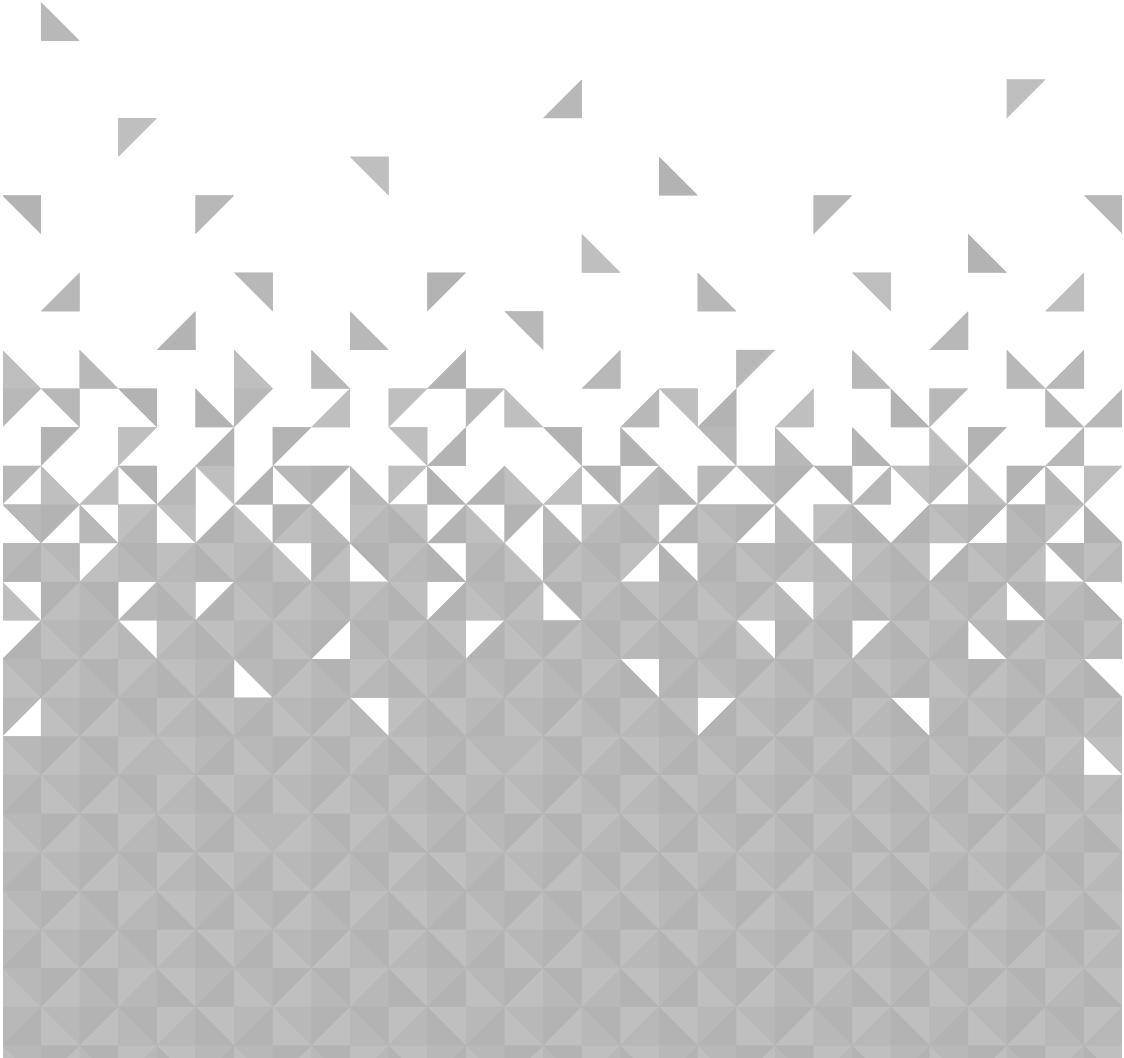

Getting to know your DVD Player

You'll be up and running in no time

Ready? Let's begin...

Please read these instructions carefully. They contain important information which will help you get the best from your DVD Player and ensure safe and correct installation and operation.

If you require any further assistance, our technical experts are happy to help. For full details, refer to the product support section at the end of these instructions.

Check the package contents

The package contains:

- 1 x DVD player
- 1 x Mains power adapter
- 1 x Remote control
- 2 x AAA Remote control batteries
- 1 x Instruction manual

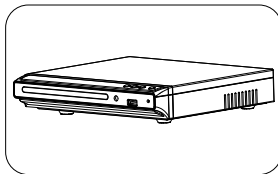

Fig 15.

1 X DVD player

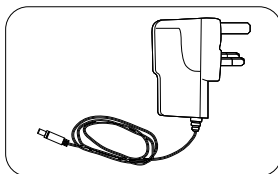

Fig 16.

1 X Mains power adapter

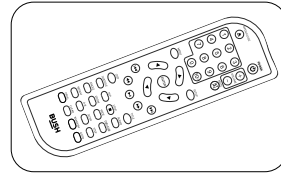

Fig 17.

1 X Remote control

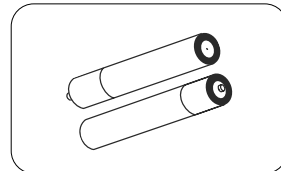

Fig 18.

2 X AAA Remote control batteries

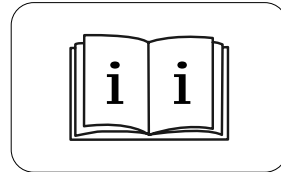

Fig 19.

1 X instruction manual

Setting up

If you require any technical guidance or find that your product is not operating as intended, a simple solution can often be found in the Troubleshooting section of this guide

If you require any technical guidance or find that your product is not operating as intended, a simple solution can often be found in the **Troubleshooting** section of these instructions.

Getting to know your DVD Player

You'll be up and running in no time

Your DVD player

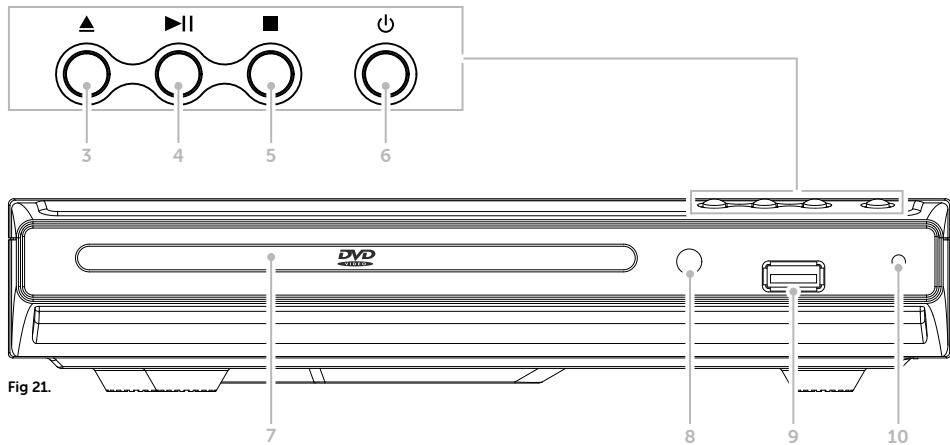
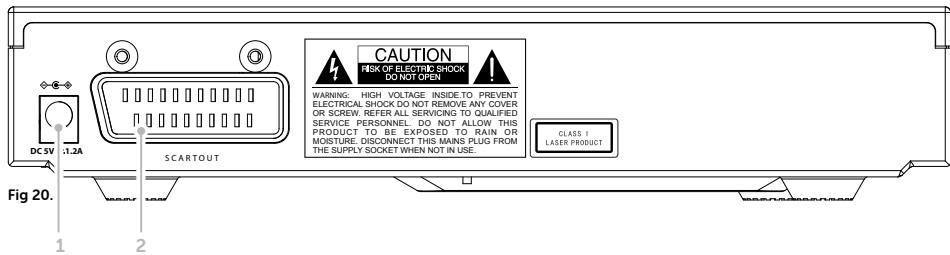

- | | |
|--|--------------------------|
| 1. Mains power socket | 6. Power on/Standby |
| 2. SCART out socket (SCART cable not included) | 7. DVD disc drawer |
| 3. DVD Disc drawer Open/Close button | 8. Remote control sensor |
| 4. Play/Pause button | 9. USB Port |
| 5. Stop button | 10. Power on/Standby LED |

or online at www.bush-support.com if you still require further assistance, call one of our experts on 0345 600 3021.

Getting to know your DVD Player

You'll be up and running in no time

Remote control

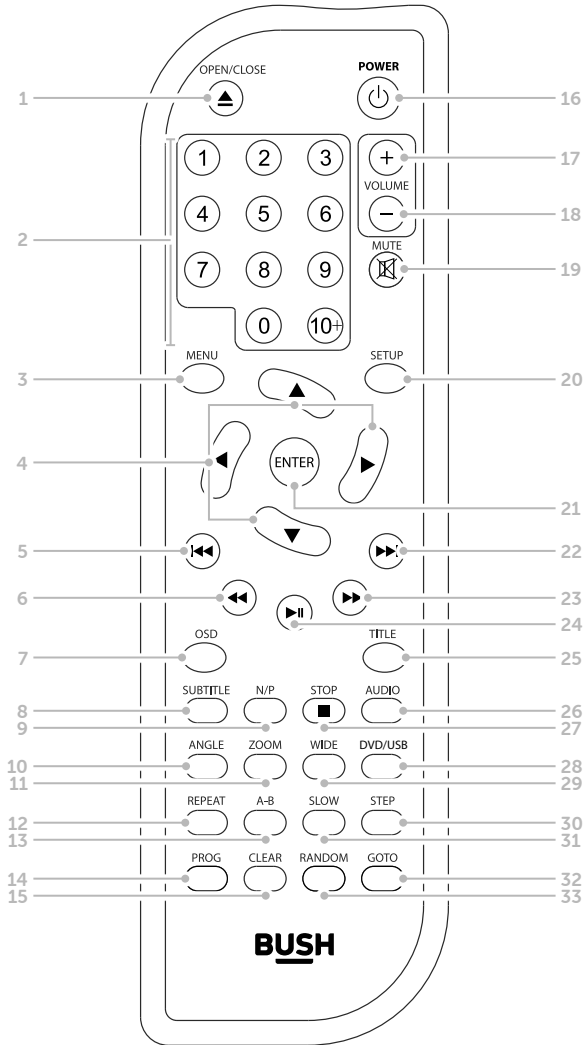

Fig 22.

If you require any technical guidance or find that your product is not operating as intended, a simple solution can often be found in the **Troubleshooting** section of these instructions.

Getting to know your DVD Player

You'll be up and running in no time

1. ▲ DVD disc drawer Open/Close
2. Numeric 0-9 and 10+
3. Menu - Press to display the DVD Menu screen (if available)
4. Navigation (Up/Down/Left/Right)
5. ⏮ Skip back
6. ⏪ Fast backward
7. On screen display (OSD) -During a movie, press to display on screen information (if available), or to turn this information off
8. Subtitle - During a movie, press to access the subtitle menu (if available)
9. NTSC/PAL- Press repeatedly to select and confirm NTSC, PAL or AUTO to match to the connected TV.
10. Angle -During a movie with multi-angle options, press repeatedly to select your required viewing angle
11. Zoom -During a movie or image display, press repeatedly to zoom in or zoom out
12. Repeat - During a movie, press repeatedly to switch to different repeat options
13. A-B - During a movie (if available), press to define the start point, press again to define the end point; the selected section will play repeatedly and continuously. Press again to cancel.
14. Program - Press to enter/exit programming
15. Clear - During programming, press to delete an incorrect input
16. ⏻ Power on/Standby
17. Volume up
18. Volume down
19. Mute - Press to turn the sound off/on
20. Setup - Press to enter/exit the Setup menu
21. Enter/Select
22. ⏭ Skip forward
23. ⏩ Fast forward
24. ⏸ Play/Pause
25. DVD title menu (if available)
26. Audio - During a movie, press repeatedly to select the language/audio channels required (if available)
27. ■ Stop - During a movie, press once to stop, press again to stop completely
28. DVD/USB- Press to access DVD or USB mode
29. Wide - Press repeatedly to change the aspect ratio
30. Step - During a movie, press repeatedly to display frame by frame. Press ⏸ Play/Pause to resume normal playback.
31. Slow - During a movie, press repeatedly to set a different playback speed. Press ⏸ Play/Pause to resume normal playback.
32. GOTO
- During a movie, press the **GOTO** button once, the Title, Chapter and Time selection menu will be displayed. Use the direction and numeric buttons to select, then press the **ENTER** button to start playing from that point
- When playing a CD, press the **GOTO** button once, the Track and Time selection menu will be displayed. Use the direction and numeric buttons to select, then press the **ENTER** button to start playing from that point
33. Random - Press to turn on/off random play

Getting to know your DVD Player

You'll be up and running in no time

Making the connections

SCART cable connection to the TV

SCART cable (not supplied)

A scart cable connection will carry both video and audio and will provide you with good picture quality, widescreen switching and stereo audio.

Connecting your DVD player to a TV with a SCART cable:

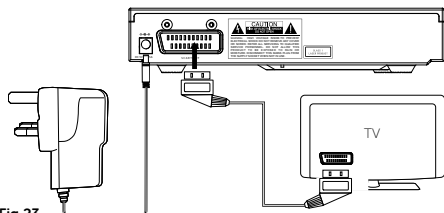

Fig 23.

Installing the remote batteries

1. Press down the tab on the remote control battery door, in the direction of the arrow, to remove it.
2. Insert the 2 x AAA batteries supplied, taking care to the + and - markings and position the batteries the correct way around.
3. Replace the battery cover, making sure that it 'clicks' shut.

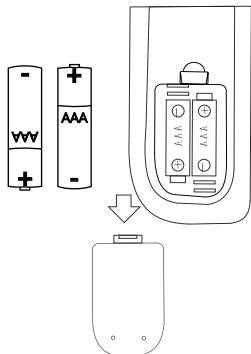

Fig 24.

Remote control working range

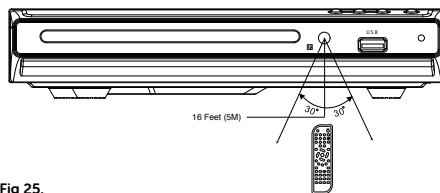

Fig 25.

The remote signal may not be received if there is an obstacle between the remote control and the remote sensor on your DVD Player.

Note: Direct sunlight or other bright light sources shining on the remote sensor may affect the performance of the remote control.

Connecting the mains power

1. Connect the mains power lead into the socket on the back of the DVD Player (fig 9).
2. Plug the power adaptor into the mains power wall socket and switch on.

Note: Do not connect the mains power until ALL other connections have been made.

3. The Red LED on the front right of your DVD Player will turn on and your DVD Player will now be in Standby mode.

Standby mode

Note: This DVD Player has been designed to go to Standby mode automatically after approximately 20 minutes of inactivity. Please press the Power button on the product or the remote control, to turn the DVD Player back on again.

1. Press the Power button on the DVD Player or on the remote control to Power on the product. The LED on the front right of your DVD Player will change to green.

If you require any technical guidance or find that your product is not operating as intended, a simple solution can often be found in the **Troubleshooting** section of these instructions.

Getting to know your DVD Player

You'll be up and running in no time

2. Press the  Power button on the DVD Player or on the remote control to go to Standby mode. The LED on the front right of your DVD Player will change to red.



This page is left intentionally blank



Using your DVD Player

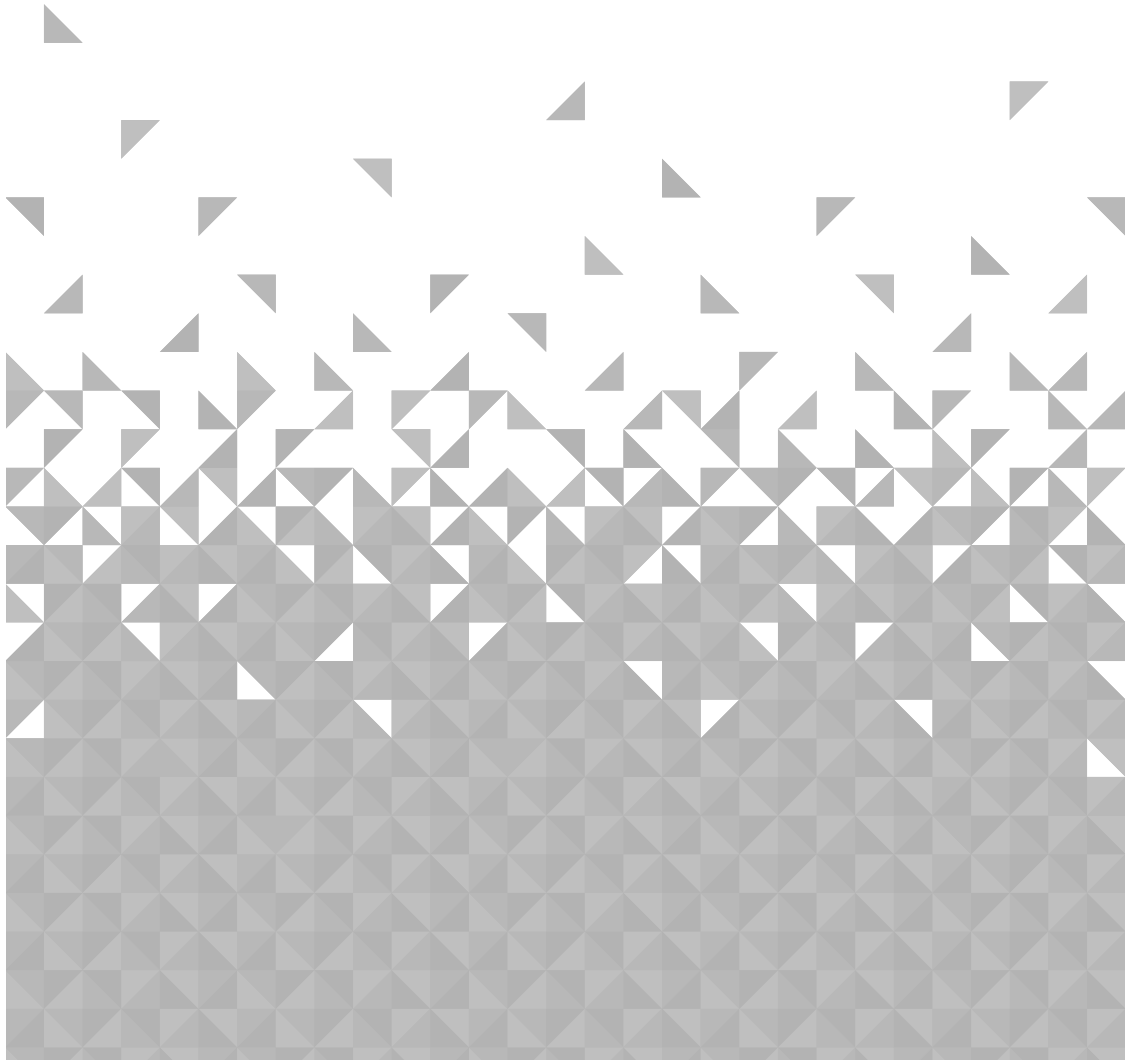

3



Using your DVD Player

Let's get started

Getting started

1. Check that you have correctly connected all the cables and have installed the batteries in the remote control.
2. Switch on your TV/Monitor and check that it is set to the correct input, which for this DVD Player is SCART.
3. With the DVD Player in Standby mode, press the  Power button on the DVD Player or on the DVD Remote control to turn the product on. The LED on the front right of the DVD Player will change to green.
4. Press the  Open/Close button on the DVD Player or on the remote control to open the DVD drawer.
5. Place the disc that you wish to play, label side up, on the DVD tray. Please ensure that the disc is laying flat within the recessed disc shaped area on the tray.
6. Press the  Open/Close button to close the drawer. The disc will start to play.

Adjust the volume

Volume +

Press and release to increase the volume in steps.

Press and hold to progressively increase the volume.

Volume -

Press and release to decrease the volume in steps.

Press and hold to progressively decrease the volume

Note: To gain optimal volume levels, adjust the volume on both the DVD Player and on the TV.

Mute

Press the  Mute button to turn off the sound.

Press the  Mute button again to turn the sound back on again.

Controls during playback



 Play/Pause

 Skip back

 Fast backward

 Skip forward

 Fast forward

 Stop - Press once to pre-stop, Your DVD Player will remember the place where the disc was stopped. Press the  Play/Pause button to resume playback from this point. Press the  Stop button twice to stop play completely.

Repeat play (DVD/CD/JPG)

DVD

If available on your DVD disc, your DVD player has repeat options of CHAPTER, TITLE, REPEAT ALL and OFF.

1. Repeatedly press the **REPEAT** button to display and activate each available option.

CD

If available on your CD disc, your DVD player has repeat options of REPEAT 1 (single track) and REPEAT ALL (repeats all the tracks on the disc) and REPEAT OFF.

1. Repeatedly press the **REPEAT** button to display and activate each available option.

Note: Some discs may not allow repeat functions.

JPG images

Your DVD player has repeat options of

- REPEAT 1 (single image)
- REPEAT DIR (repeat all images in a folder)
- REPEAT ALL (to repeat all images on the disc)
- REPEAT OFF.

1. Repeatedly press the **REPEAT** button to display and activate each available option.

If you require any technical guidance or find that your product is not operating as intended, a simple solution can often be found in the **Troubleshooting** section of these instructions.

Using your DVD Player

Let's get started

Zoom (DVD, Images)

With your DVD Player you can zoom into an image or part of an image on the screen. Options of X2, X3, X4 and 1/2, 1/3 and 1/4 size are available.

1. Press the **ZOOM** button to activate the Zoom feature. Repeatedly press the **ZOOM** button to cycle through and display the available options.
2. When you are in Zoom mode, you can use the ▲ up, ▼ down, ◀ left and ▶ right buttons to scroll to the part of the picture that you wish to Zoom into.
3. To turn the Zoom feature off, repeatedly press the **ZOOM** button until ZOOM: OFF is displayed.

Note: Zooming into an image will degrade the quality as the pixels of the image are being enlarged.

Multi-angle (DVD)

Some DVDs contain scenes which have been shot simultaneously from a number of different angles. For these discs, the same scene can be viewed from each of these different angles by using the **ANGLE** button.

1. During playback, repeatedly press the **ANGLE** button to cycle through the available angles.

Note: If different angles are not available on your DVD 'Invalid key' will be displayed.

Subtitles (DVD)

1. Press the Subtitle button to turn the subtitles in a movie (if available), on or off.

Numeric keypad (DVD/CD)

You can use the numeric keys to go to a particular Chapter or Track when playing a DVD or CD disc.

1. Enter the chapter or track number using the numeric keypad.

2. For chapter or track number 10, press the 10+, followed by the 0 button. For chapters or tracks higher than 10, such as track 24, press the 10+ button twice and then the 4 button.

DVD/USB

You can switch between DVD and USB mode to view images or play music files from a USB stick.

1. Insert the USB stick into the USB socket on the front of your DVD Player.
2. Press the DVD/USB button and use the ▼ down button to highlight USB. Press the **ENTER** button.
3. Your DVD Player will now read the content on your USB stick. Please wait for a few moments.
4. When the content on your USB stick is displayed, you can use the ▲ up, ▼ down, ◀ left and ▶ right buttons to move to the image or music file that you want, then press the **ENTER** button.
5. To go back to DVD mode, press the DVD/USB button and use the ▲ up button to highlight DVD. Press the **ENTER** button.

Programming (DVD/CD)

During DVD or CD playback, you can program the order of the Chapter, Title, or Track that you watch.

1. Press the **PROG** button. The program setting menu will be displayed:

DVD

T	C	T	C	T	C	T	C
1 -- :-	5 -- :-	9 -- :-	13 -- :-				
2 -- :-	6 -- :-	10 -- :-	14 -- :-				
3 -- :-	7 -- :-	11 -- :-	15 -- :-				
4 -- :-	8 -- :-	12 -- :-	16 -- :-				
PROGRAM				PLAY CLEAR			

Fig 26.

Using your DVD Player

Let's get started

CD

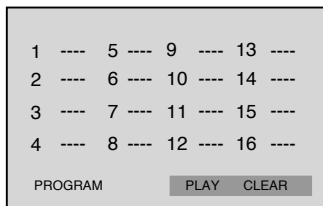

Fig 27.

2. Use the direction and numeric buttons to enter and set the desired Title, Chapter or Tracks
3. After you have finished programming, use the direction buttons to highlight PLAY and then press the **ENTER** button.
4. To reset the programmed entries and start again. Use the direction buttons to highlight CLEAR and then press the **ENTER** button.

System setup

The SETUP menu enables you to set your preferences for the different options available on your DVD Player. You can use the **▲** Up, **▼** Down, **◀** Left and **▶** Right buttons to highlight each function or option and then press the **ENTER** button to confirm.

1. Press the SETUP button, to display the SETUP menu options.

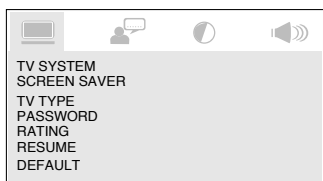

Fig 28.

2. Use the **▶** Right and **◀** Left buttons to move across the 4 Setup menu option screens. A yellow bar will appear under the current menu option screen.

3. You can then use the **▲** Up, **▼** Down, **◀** Left and **▶** Right buttons to highlight each function or option and then press the **ENTER** button to confirm.

Setup - TV Type

The TV type option enables you to set the aspect ratio of the DVD Player to match to the connected TV. The following options are available:

- 4:3/PS (pan and scan)
- 4:3/LB (letter box)
- 16:9 (widescreen).

Setup - Password

You can set the viewing rating for your DVD Player and protect this with your own password:

Setting your own password:

1. Within the SETUP menu, scroll down and highlight PASSWORD and press the **ENTER** button. The 4 digit password and lock symbol will be highlighted **+**.
2. Enter the default password of 0000 and press the **ENTER** button. The lock symbol will change to be unlocked **+**.
3. Use the **▶** right arrow to highlight the 4 digit password and unlock symbol again. Enter your own 4 digit password and press the **ENTER** button. The lock symbol will change to be locked **+** again and your new 4 digit password has been saved.

To set the viewing rating:

1. Follow the steps above and ensure that the PASSWORD screen is displaying the unlock symbol **+**. If the lock symbol is shown, enter the default password of 0000 or the new password you have set.
2. Scroll down and highlight RATING Use the **▶** Right arrow to move to the Rating options, then use the **▲** Up and **▼** Down buttons to highlight your chosen rating. Press the **ENTER** button to confirm.

If you require any technical guidance or find that your product is not operating as intended, a simple solution can often be found in the **Troubleshooting** section of these instructions.

Using your DVD Player

Let's get started

3. Scroll up and highlight PASSWORD and then press **ENTER**. Enter the default password of 0000 or the new password you have set.
4. The lock symbol will change to be locked  and your viewing rating is now password protected.

Setup - Resume

There are two options available, ON or OFF. If you set the Resume feature to ON and you play a disc that you have played before, the disc will start from the place it was last stopped.

Setup - Default

If you highlight this option and then move to RESTORE and then press the **ENTER** button. The DVD Player will be reset to its factory default settings.

Setup - Downmix

You can change the way that the audio is assigned to each speaker. There are two options available:

- LT/RT - the rear Left/Right channels on a Dolby 5.1 DVD disc will play on both the Left and Right speakers.
- STEREO - the rear left channel will play on the Left Speaker and the rear right channel will play on the Right speaker.

Note: The function depends on the Audio recording of each disc.



This page is left intentionally blank





Other information 4

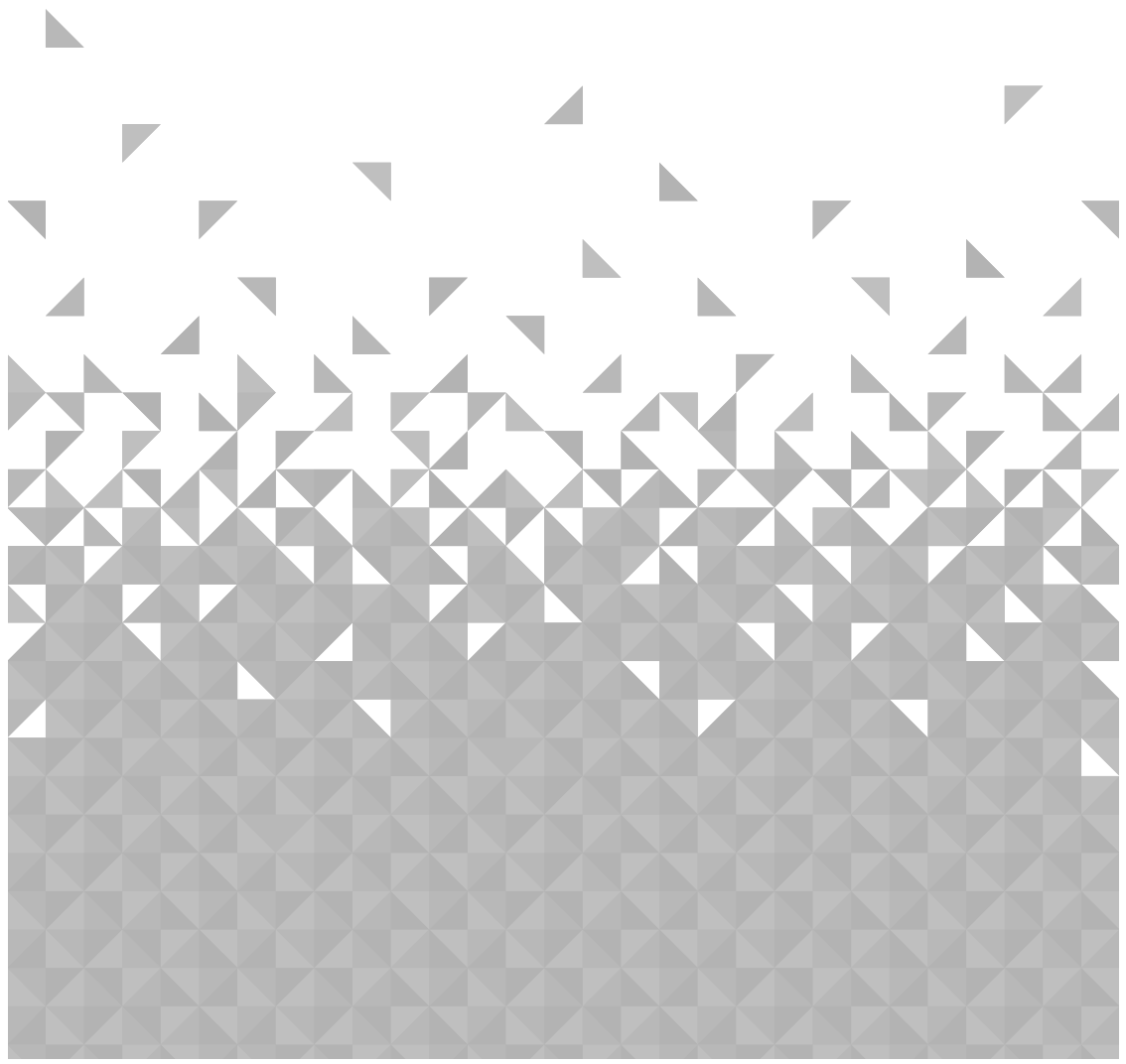

Other information

Helpful technical information

Technical specification

DVD Player	
Power	DC 5V/1.2A
Input	100-240V 50/60Hz
Output	DC 5.0V 1.2A 6.0W
Average active efficiency	76.91%
No-load power consumption (for power adaptor)	0.07W
Frequency response	<ul style="list-style-type: none">• CD: 20HZ-20KHz• DVD:20Hz-44KHz
Audio S/N ratio	>70dB
Power consumption	6W MAX
Video/picture:	MPEG1 V2.0 MPEG2
Video resolution	Upto 720*480/576 (30 frames per second).
Audio	MPEG LAYER2 STANDARD
Audio output (analog audio)	1.8V(1K/0dB 10K load)
Component video:	RGB
Output:	R:1Vp--p G/B:0.7Vp--p (75Ω load)
Dimensions:	225 x 200 x 38mm
Remote control	
Batteries	2 x AAA batteries (supplied)

If you require any technical guidance or find that your product is not operating as intended, a simple solution can often be found in the **Troubleshooting** section of these instructions.

Other information

Helpful technical information

USB Port Supported Media

Max. USB storage device memory capacity: 32GB

Picture format: JPG

File type	Video Codec	Audio Codec	Resolution
AVI (.avi)	MP4V Xvid MPEG-1	Dolby Digital (AC3) WMA/PCM/LPCM AAC-LC(2ch) MPEG-Audio (MP1/MP2/MP3)	720*480/576 (30fps)
MPG (.mpg/.mpeg)	MPEG-1/MPEG-2	Dolby Digital (AC3) LPCM MPEG-Audio (MP1/MP2/MP3)	720*480/576 (30fps)
DAT (.dat)	MPEG-1/MPEG-2	Dolby Digital (AC3) LPCM MPEG-Audio (MP1/MP2/MP3)	720*480/576 (30fps)
VOB (.vob)	MPEG-1/MPEG-2	Dolby Digital (AC3)	720*480/576 (30fps)

Audio	Bit Rate	Sampling Rate
MP3	16kbps ~ 320kbps	8K ~ 48KHz

or online at www.bush-support.com if you still require further assistance, call one of our experts on 0345 600 3021.



This page is left intentionally blank





Product support

5

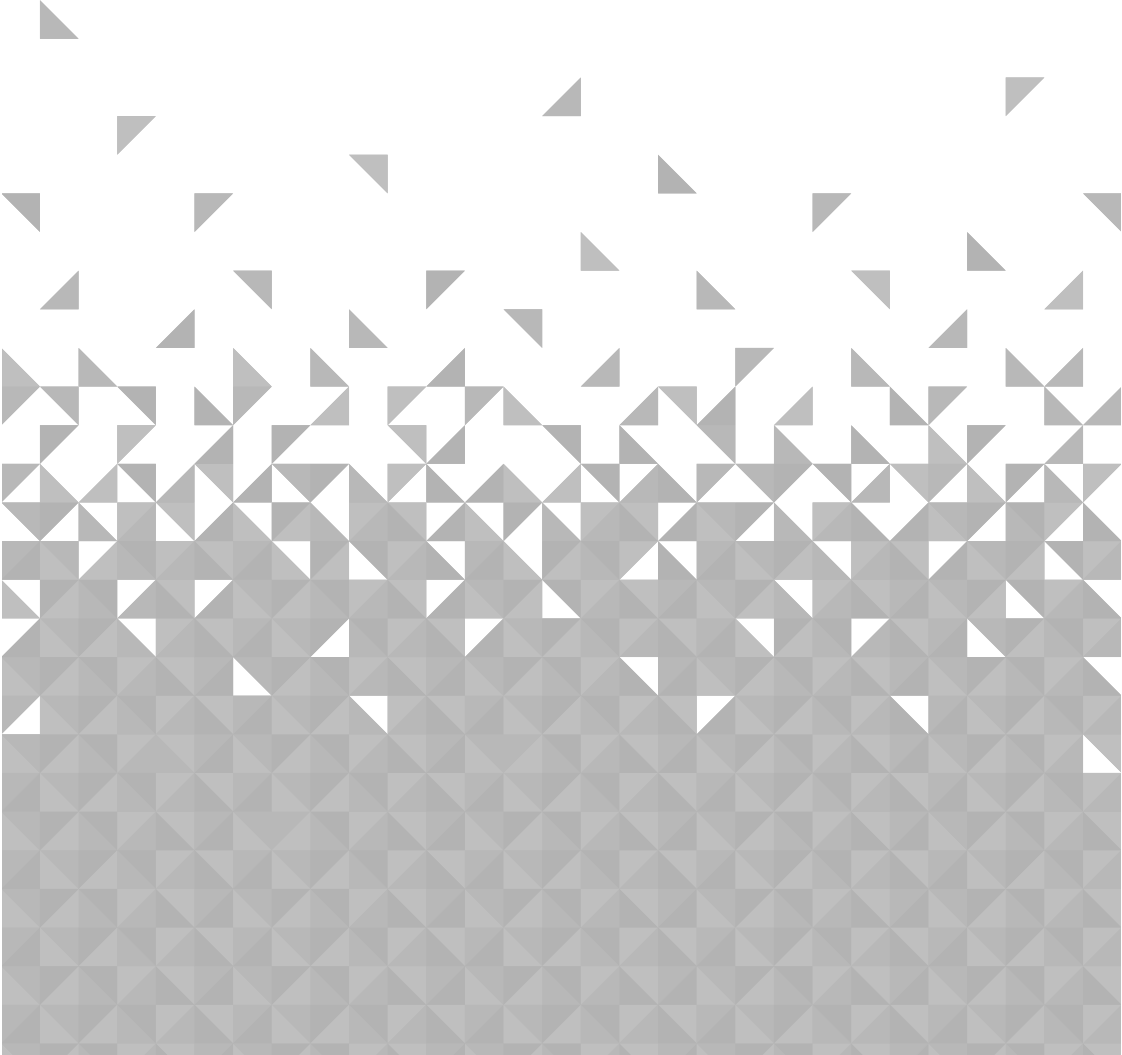

Product support

Help is always at hand

Troubleshooting

No power.

- Check the mains power plug connection at the wall socket and ensure that it is switched on.
- Check that the DVD player is not in Standby mode. The LED on the front of the DVD Player will be green when the product is powered on and red in Standby mode.

No picture and/or No sound

- Check the connections between the DVD player and the TV.
- Check that the DVD Player is not Muted. Increase the volume on the DVD Player and on the TV.

Unable to play

- There is no disc in the DVD/CD tray or it is upside down.
- The disc is not loaded properly. Press the ▲ Open Close button and check that the disc is correctly placed within the recessed area and that the picture side is facing up.
- It is the wrong type of disc or the disc is corrupted. This DVD Player is compatible with PAL Region 2 discs.
- The disc may be dirty. Clean the disc and try again

Some functions and features do not work

- Not all features and functions are available on all discs. Please try on a different disc.

The remote control is not working

- The batteries may be exhausted. Replace with new good quality batteries.
- The remote signal may not be received if there is an obstacle between the remote control and the remote sensor on your DVD Player.
- Direct sunlight or other bright light sources shining on the remote sensor may affect the performance of the remote control.

The product powers off after 20 minutes.

- This DVD Player has been designed to go to Standby mode automatically after approximately 20 minutes of inactivity. Please press the ⏻ Power button on the product or the remote control, to turn the DVD Player back on again.

If you require any technical guidance or find that your product is not operating as intended, a simple solution can often be found in the **Troubleshooting** section of these instructions.

Product support

Help is always at hand

Help and assistance

If you require any technical guidance or find that your DVD Player is not operating as intended, a simple solution can often be found in the **Troubleshooting** section of these instructions or online at **www.bush-support.com**

If you still require further assistance, call one of our experts on **0345 600 3021***. To help give us give you a fast and efficient service please have the following information ready:

Model Ref.

Serial number

You can find these on the rating plate - a small information panel (usually a sticker or metal plate) on the rear or base of your product

Date of purchase

This will be shown on your receipt

Local call rates applies*

Lines open 8am-7pm Monday to Saturday and 10am-4pm Sunday.

*Calls to Bush enquiry lines may attract a charge and set up fee from residential lines depending on your call plan/tariff. Mobile and other providers costs may vary, see www.bt.com/pricing for details.

For Security and training purposes, telephone calls to and from customer service centres maybe recorded and monitored. Calls from Republic of Ireland will attract international call charges.

or online at **www.bush-support.com** if you still require further assistance, call one of our experts on **0345 600 3021**.

Product support

Help is always at hand

Disposal



- Disposal of your old product. Your product is designed and manufactured with high quality materials and components, which can be recycled and reused
- When this crossed out wheeled bin symbol is attached to a product it means the product is covered by the European Directive 2012/19/EC.
- Please make yourself aware of the local collection system for electrical and electronic products.
- Please act according to your local rules and do not dispose of your old products with your normal household waste.
- The correct disposal of your old product will help prevent potential negative consequences for the environment and human health.

This product is intended for use within the UK.



Declaration of Conformance

Hereby, Argos Ltd., declares that this DVD Player - CDV-03965/134250099, is in compliance with the essential requirements and other relevant provisions of the following EC directives: 2014/35/EU Low voltage directive and the 2014/30/EU EMC directive. The complete declaration of conformity can be obtained by contacting <http://www.bush-support.com/>



"DVD logo" is a trademark of DVD Format/Logo Licensing Corporation.

If you require any technical guidance or find that your product is not operating as intended, a simple solution can often be found in the **Troubleshooting** section of these instructions.

Product support

Help is always at hand

BUSH

Call us now and register your 12 month guarantee

Thank you for choosing Bush. Your new product is guaranteed against faults and breakdowns for 12 months. Don't forget to register it with us today so we can provide you with our best possible after-sales service and useful updates.

www.bushregistration.co.uk

FREEPHONE*

0800 597 8548

Lines are open 8am - 8pm, 365 days a year. *Calls may be recorded and monitored.

Your Bush Guarantee

This product is guaranteed for twelve months from the date of original purchase. Any defect that arises due to faulty materials or workmanship will be repaired free of charge (or if applicable the product will be replaced or the purchase price refunded) where possible during this period by the dealer from who your purchased the unit.

The guarantee is subject to the following provisions:

- The guarantee does not cover accidental damage, misuse, cabinet parts, knobs or consumable items.
- The product must be correctly installed and operated in accordance with the instructions contained in the manual.
- It must be used solely for domestic purposes. The guarantee will be rendered invalid if the product is re-sold or has been damaged by inexpert repair.
- Specifications are subject to change without notice.
- Bush disclaim any liability for loss or damage arising from the breakdown of the product.
- This guarantee is in addition to and does not diminish your statutory or legal rights.

Important Data Protection Information

To find out how we and Domestic & General Insurance Plc use your data please refer to the guarantee registration material or visit www.bushregistrations.co.uk.

Guarantor: Argos Limited, London, EC1M 6HA, UK. Argos.IN.UK Forestside Shopping Centre, Upper Galwally, Belfast, BT8 6FX, UK.

or online at www.bush-support.com if you still require further assistance, call one of our experts on **0345 600 3021**.

BUSH

Contact:

www.bush-support.com

Helpline: 0345 600 3021

