

40m Tower Airer Instructions

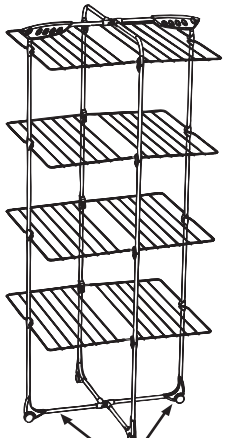

Fig. a
Pivoting

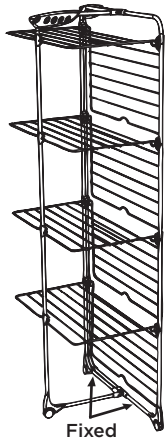

Fig. b
Fixed

Pack Contents

a+b. Upper tube assembly x 1

c+d. Lower tube assembly x 1

e. Coat hanger holder x 2

f. Wheel corner cap assembly x 4

g. Wheel corner screws x 4

h. Flat dry shelf x 8

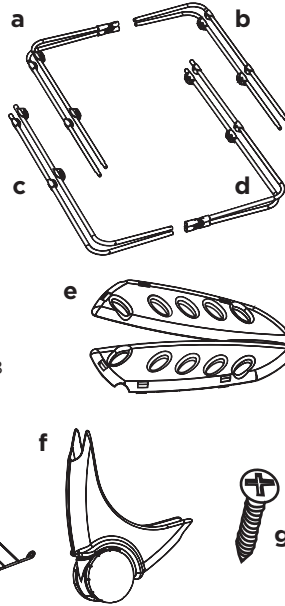

1. Assembly Instructions

Equipment required: Scissors and a Phillips (cross head) screwdriver.
For easy assembly lay tubes on a large flat surface whilst following stages 1 to 4.

(1.) Slot together upper tube assembly parts a & b, (2.) then parts c & d. Ensure each spring button clicks into each placement hole. (3.) When successfully assembled the shelf clips should be level on either side (see image below).

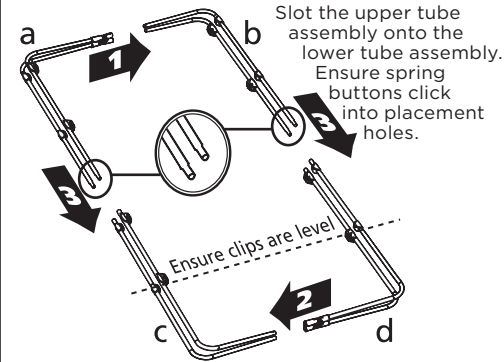

2. Wheel Corner Caps

Locate the holes in the corners of the lower tubes.

Attach a wheel corner assembly onto each corner of the lower tube assembly.

Ensure the plastic alignment pegs are firmly fitted into the holes located in the bottom of the lower tube assembly.

Screw each corner to the lower tube assembly using the screws provided.

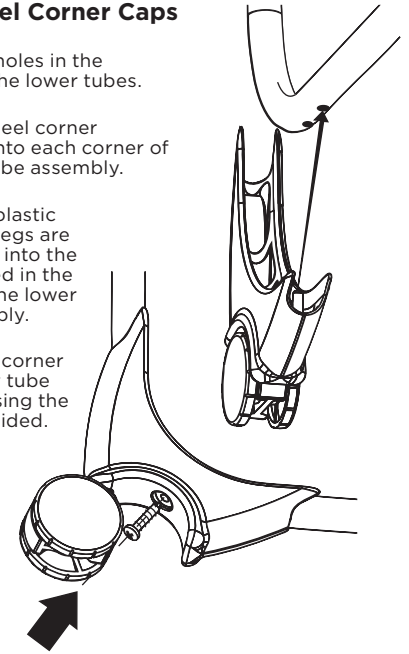

3. Clothes Hanger Holder

Attach the 2 coat hanger holders to the top of the pivoting tubes (see Fig. a).

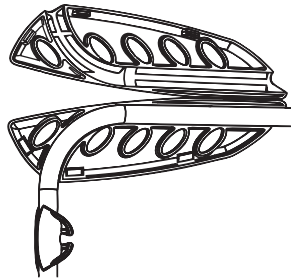

Hold in position and fold the top part over making sure all clips are engaged.

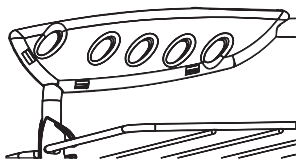

4. Fitting the Flat Dry Shelves

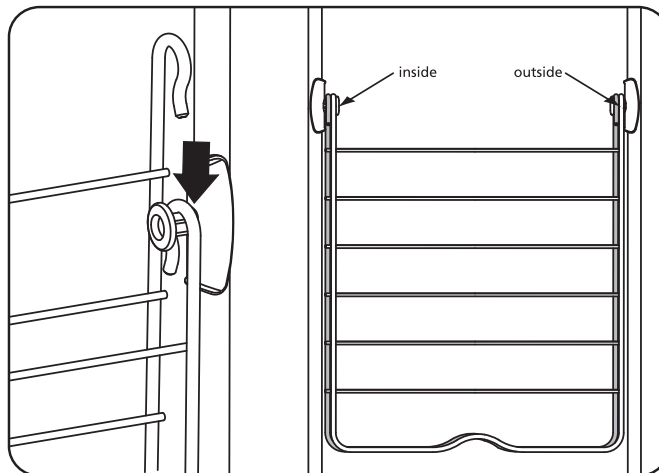

a. With the shelf held in a vertical orientation as shown, clip the shelf hooks securely onto the support pins on either side. Clip the opposite shelf onto the same support pins.

b. IMPORTANT
Ensure each shelf side has one hook inside and one hook outside of the support pins, as shown above.

5. Using the Flat Dry Shelves

To locate the wire shelves in a horizontal position lift the shelf and depress the outer wire to locate into the clip.

To disengage push the outer wire inwards.

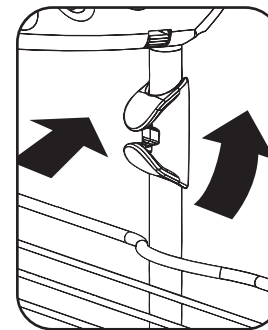

6. For storage, disengage all shelves and twist the frame allowing it to fold flat.

Warning!

Do not overload airer.
Maximum load - 25kg.
Keep fingers away from folding parts.
Load airer from the bottom upwards to avoid it tipping over.
For indoor use only.
Do not allow children to play on the airer.

This product has been designed and manufactured to the high standards you would expect from Britain's leading producer of homecare products. This product is guaranteed for 2 years from date of purchase. This guarantee is limited to the structure of the airer under normal use indoors. Please retain receipt as proof of purchase. Full details of this limited guarantee are available on our website or through our customer helpline. Your statutory rights are not affected.

SAFETY FIRST: To avoid danger of suffocation keep this wrapper away from babies and children.

Made in China.

To contact us please call our customer helpline on 01706 716114 or e-mail us at info@minky.co.uk

Minky Homecare, Vale Mill (Rochdale) Ltd,
Robinson Street, Rochdale, OL16 1TA

www.minky.com