

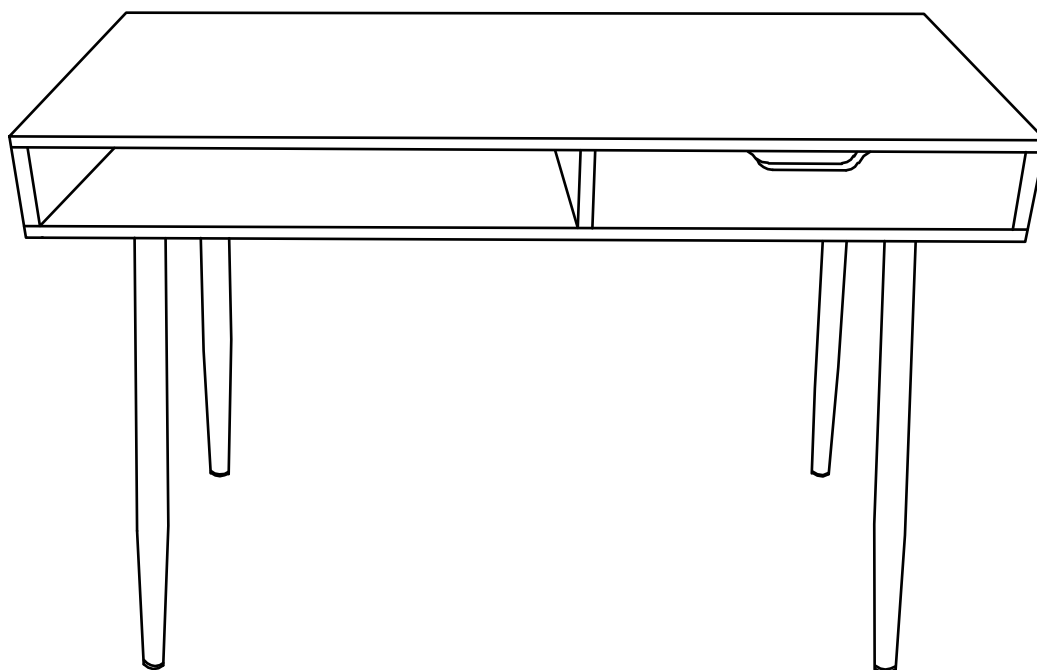

CONCRETE STYLE DESK

habitat 



Spare Parts

 www.argos-support.co.uk

 Help@ClickSpares.co.uk

 0370 112 1928

Customer Support

 0345 640 2020



Safety and Care Advice

Product Details

CONCRETE STYLE DESK 847/2544

IMPORTANT, RETAIN FOR FUTURE REFERENCE: READ CAREFULLY.

- Keep children and animals away from the work area, small parts could choke if swallowed.
- Make sure you have enough space to layout the parts before starting.
- This product has been constructed to be used in the domestic environment only and not for commercial purposes.

- Assemble the item as close to its final position (in the same room) as possible.
- Assemble on a soft level surface to avoid damaging the unit or your floor.

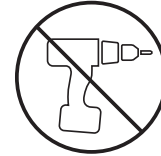

- We do not recommend the use of power drill/drivers for inserting screws as this could damage the unit. Only use hand screwdrivers.
- Parts of the assembly will be easier with 2 people.
- Dispose of all packaging carefully and responsibly.

Care and maintenance

- Only clean using a damp cloth and mild detergent. Do not use abrasive cleaners.
- Use a dry cloth to clean the product, furniture polish is not recommended.
- From time to time check that there are no loose screws, nuts or bolts. If there are please re-tighten.
- This product should not be discarded with household waste. Take to your local authority waste disposal centre.

Additional Guidance

- Assemble all parts and bolts loosely during assembly, only once the product is complete should you fully tighten the bolts.
- Regularly check and ensure that all bolts and fittings are tightend properly.
- Maximum user weight 50kg
- This product is compliant EN12521.

Sainsbury's Argos is a trading name of both: Argos Limited, Registered office: 489-499 Avebury Boulevard, Milton Keynes, United Kingdom, MK9 2NW, registered number: 01081551 (England and Wales); and Sainsbury's Supermarkets Limited, Registered office: 33 Holborn, London, EC1N 2HT, registered number: 03261722 (England and Wales). Both companies are subsidiaries of J Sainsbury's plc.

Fittings (Shown to scale)

Bag 1

A

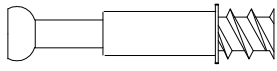

32mm camlock screw x 14

B

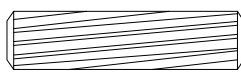

30mm Wooden dowel x 12

C

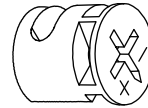

12mm Camlock nut x 14

D

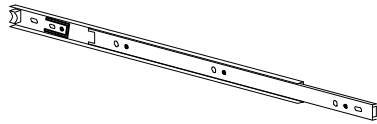

390mm Runner X 2

E



14mm Screw x 12

F

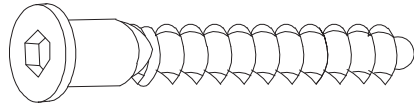

38mm Screw x 6

G

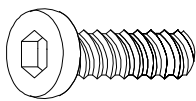

15mm Bolt x 16

H

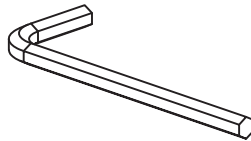

Allen Key x 1

I

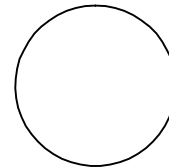

Stickers
(\varnothing 20 mm)x16

Panels

1 Table Top x 1
(114.9 x 47.9 cm)

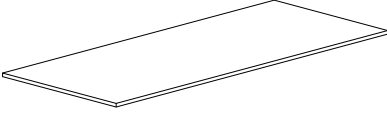

2 Side Board x 1
(47.8 x 9 cm)

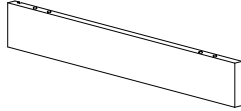

3 Divider x 1
(46 x 9 cm)

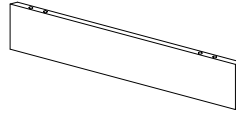

4 Side Board x 1
(47.8 x 9 cm)

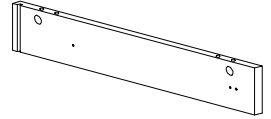

5 Back Board x 1
(113 x 10 cm)

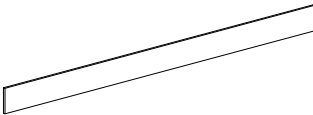

6 Bottom Board x 1
(114.9 x 47.9 cm)

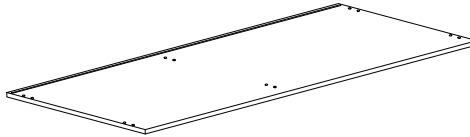

7 Leg x 4
(Φ3.8 x 63.3 cm)

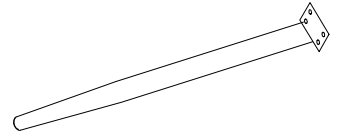

8 Drawer Back Board x 1
(43.1 x 7.8 cm)

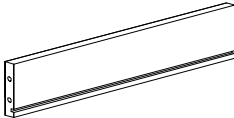

9 Drawer Bottom Board x 1
(39.5 x 44 cm)

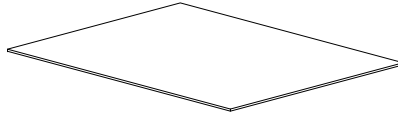

10 Drawer Left Side Board x 1
(40 x 7.8 cm)

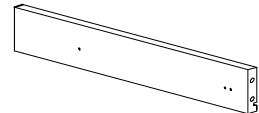

11 Drawer Right Side Board x 1
(40 x 7.8 cm)

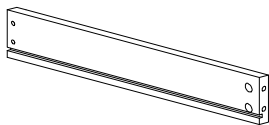

12 Drawer Front Board x 1
(47.5 x 8.5 cm)

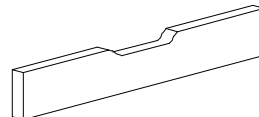

Tools required



Phillips screwdriver
(small & medium)

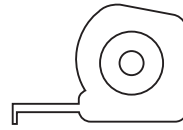

Ruler/tape
measure

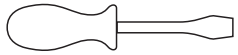

Phillips screwdriver
(small & medium)

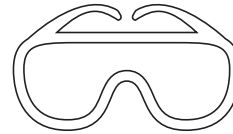

Eye protection
(when using a
hammer or glue)

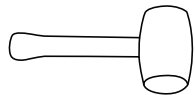

Rubber hammer

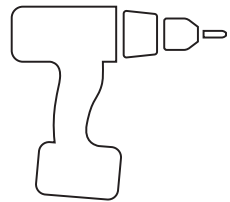

Power Drill

1

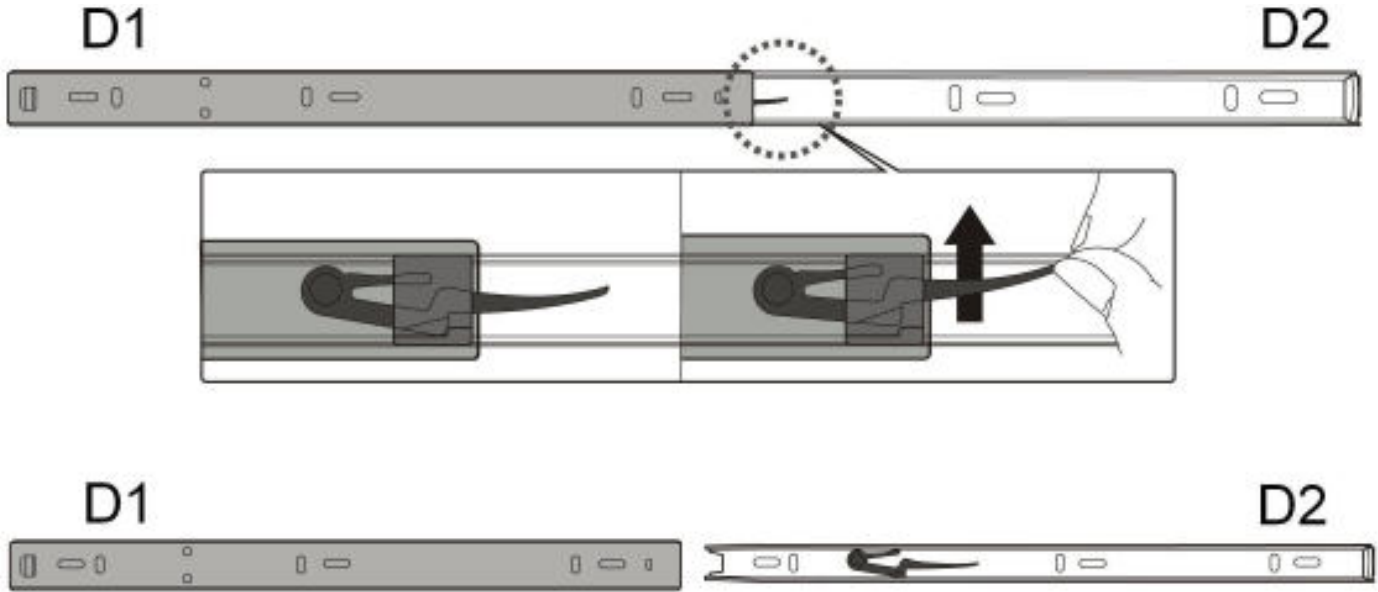
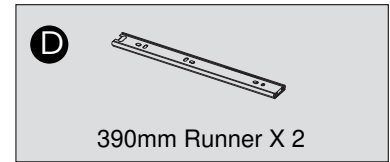
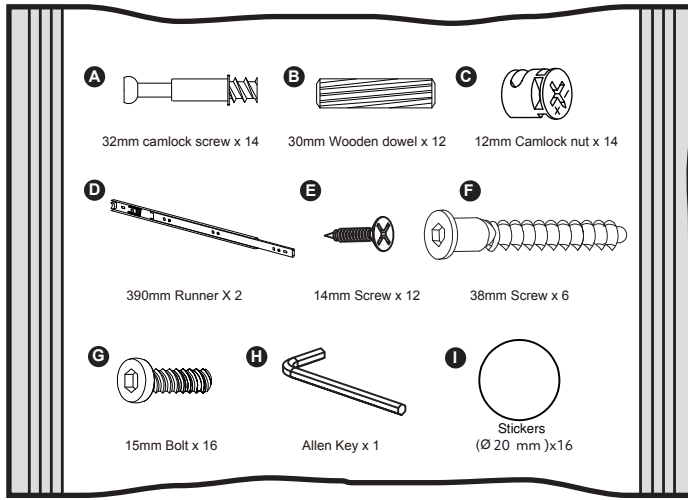

Note: Press the plastic slide in the indicated direction to separate drawer runner **D1 and **D2** before assembling.**

2

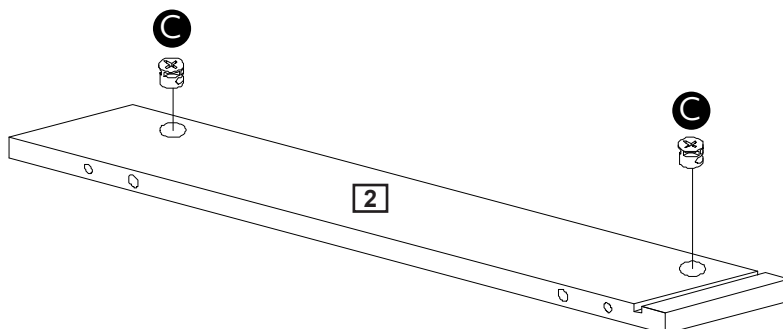
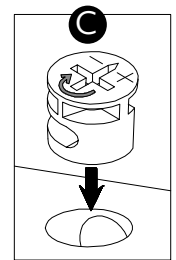
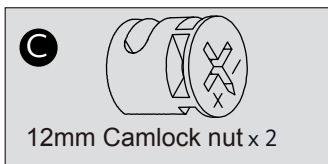

3

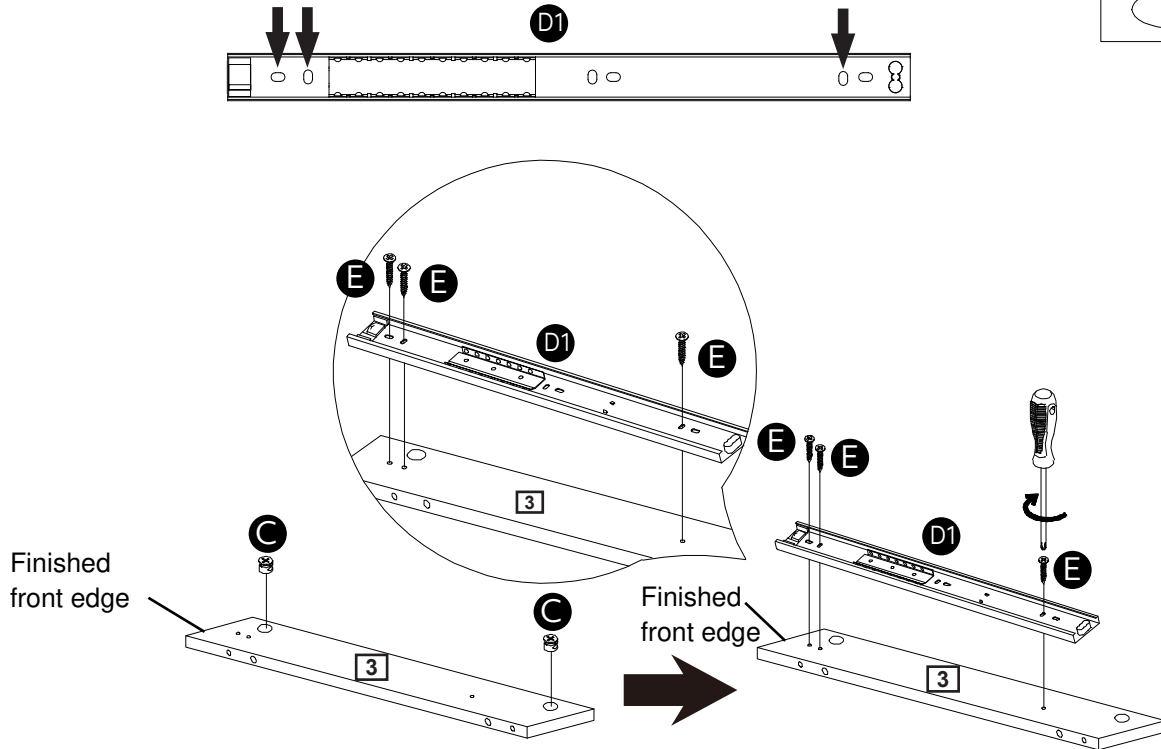
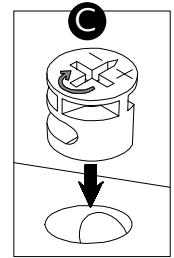
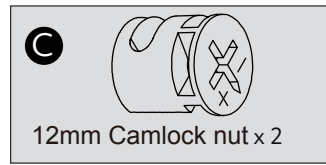
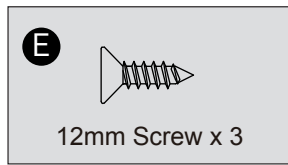
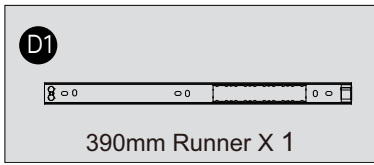

4

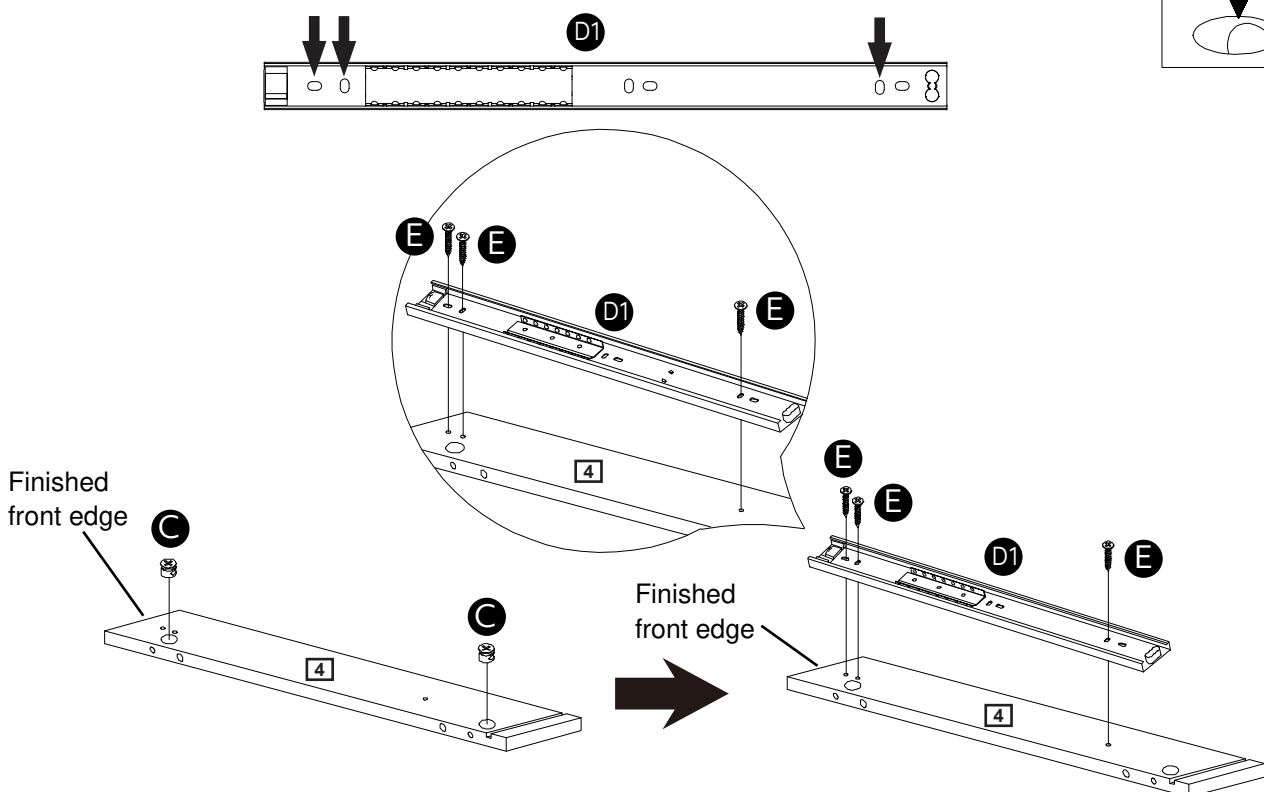
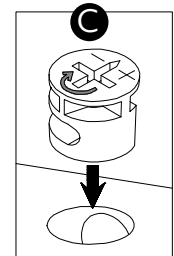
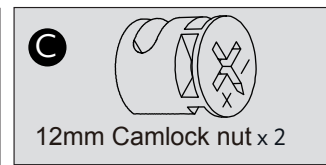
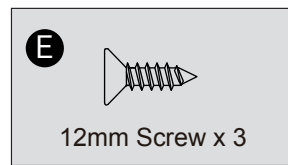
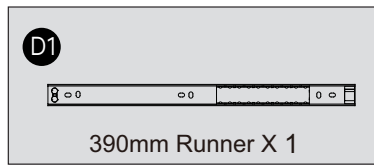

7

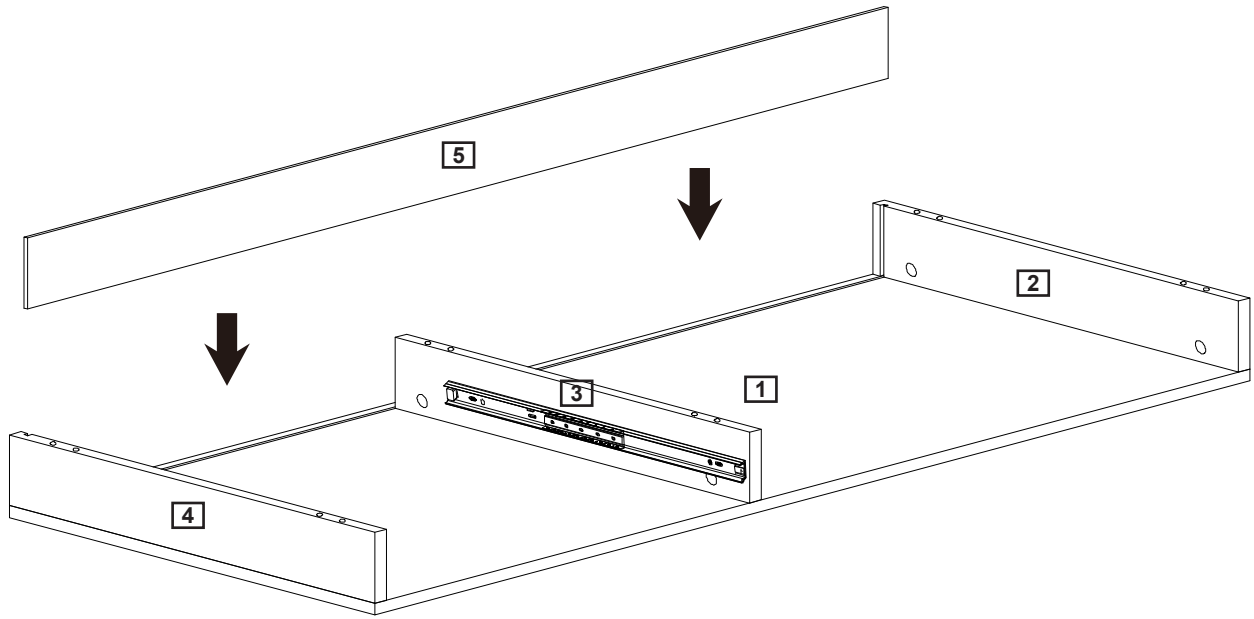

8

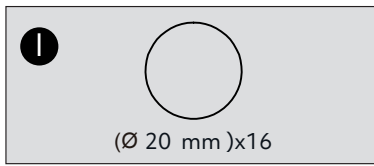

NOTE:

This is the upper side of bottom board 6

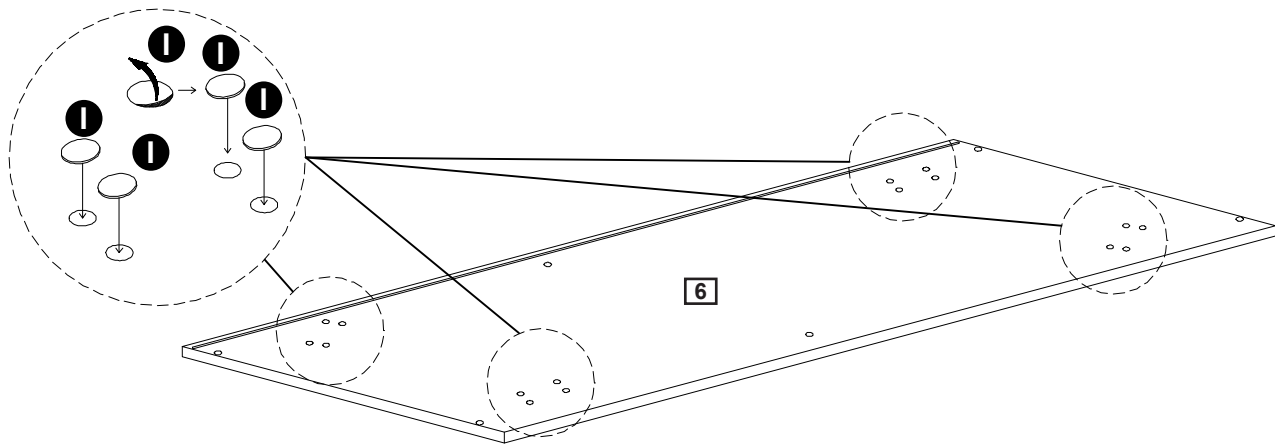

9

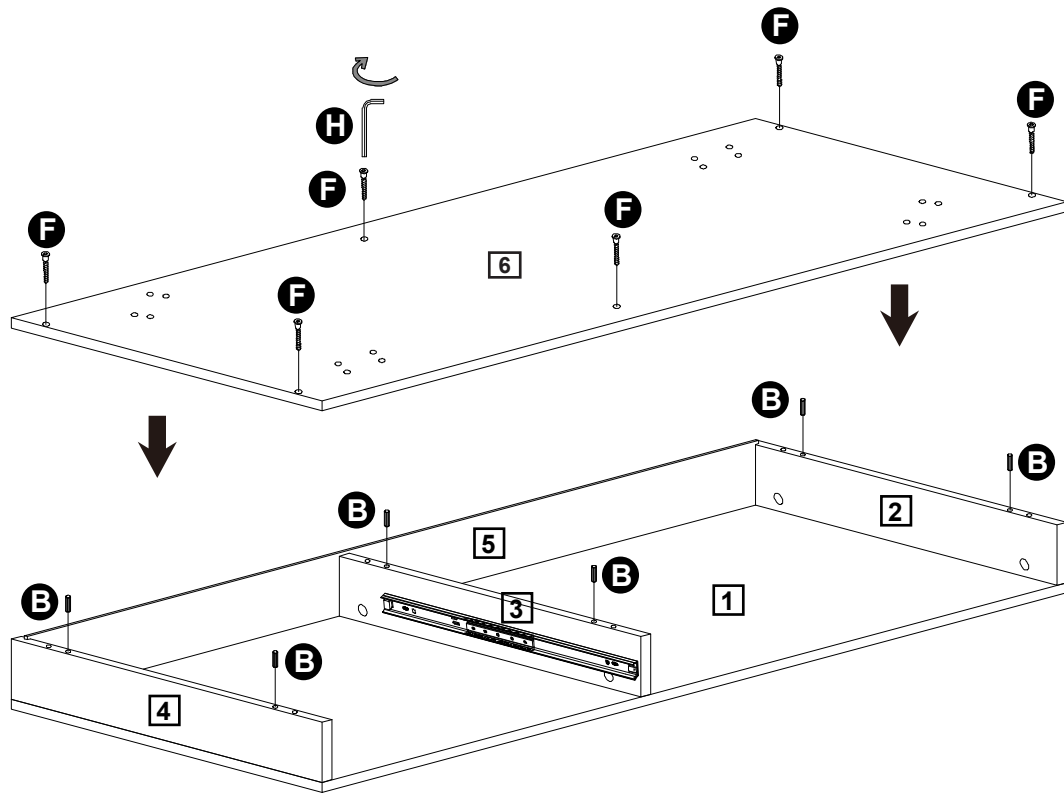
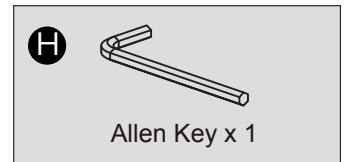
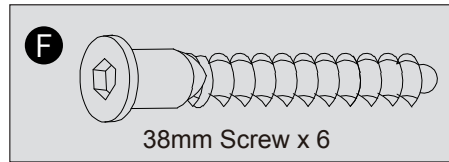
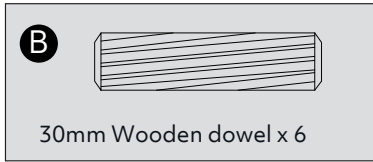

10

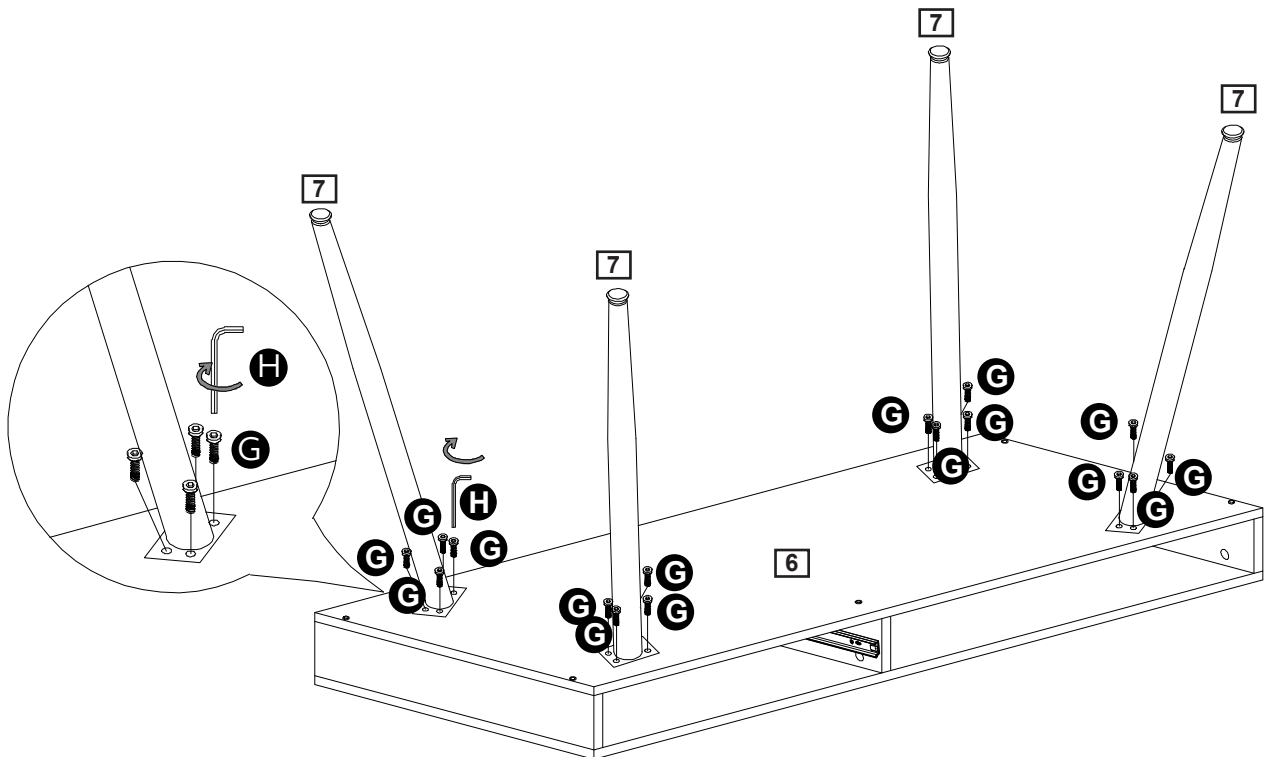
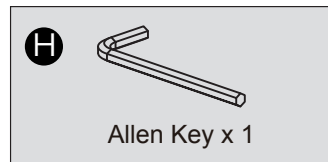
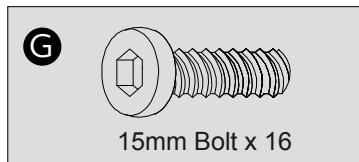

11

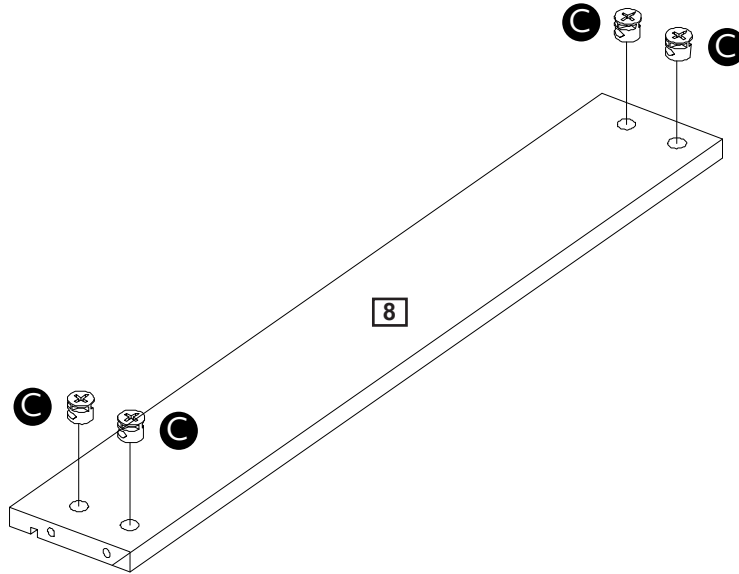
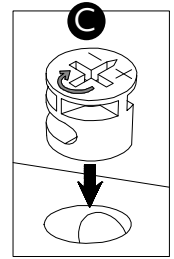
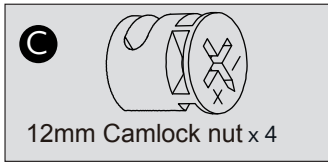

12

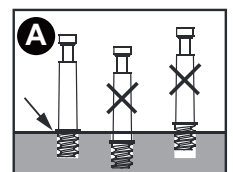
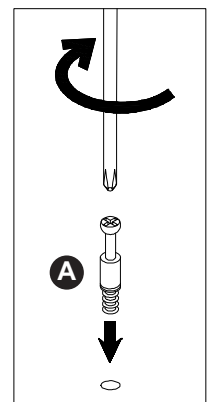
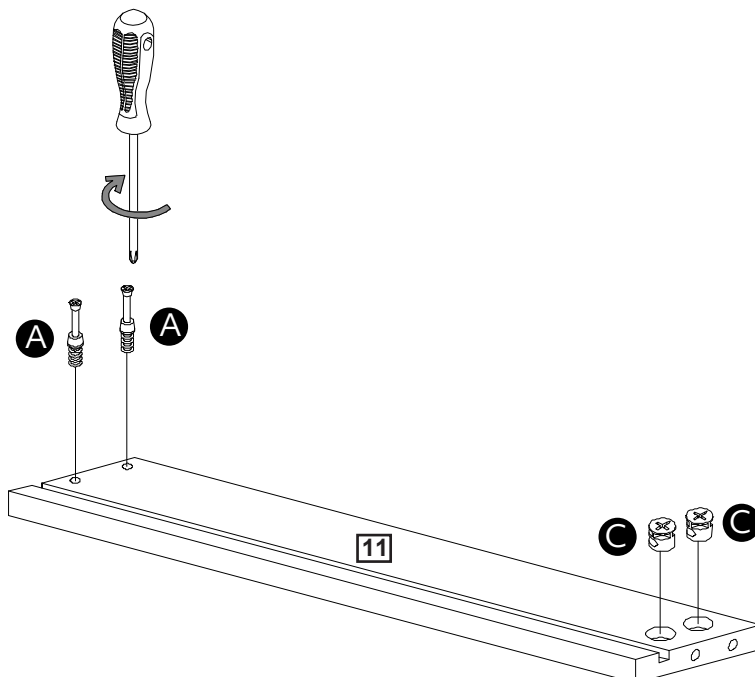
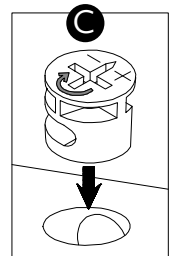
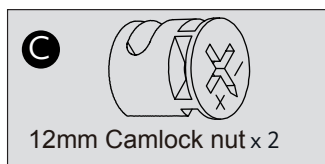
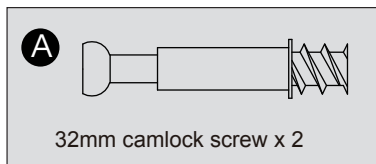

13

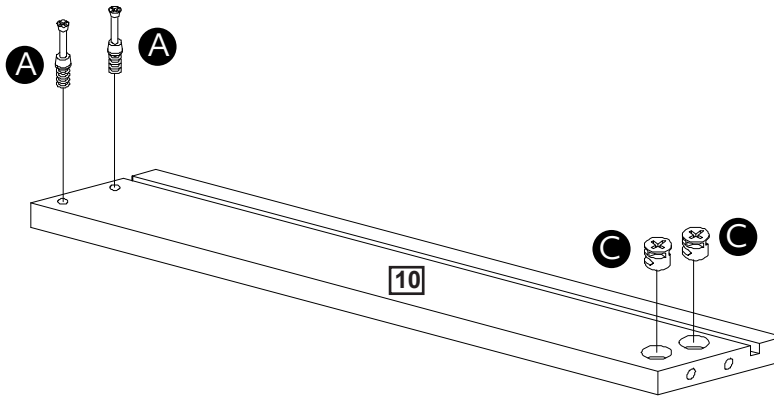
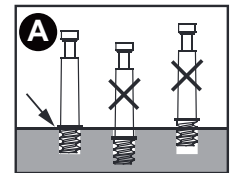
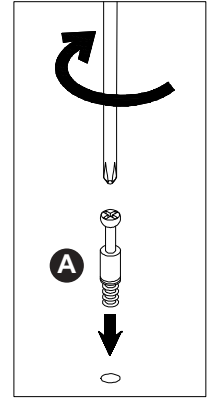
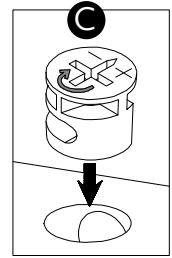
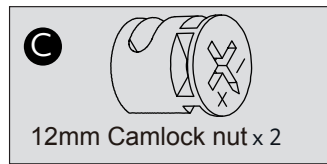
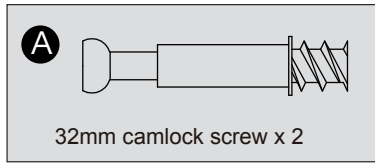

14

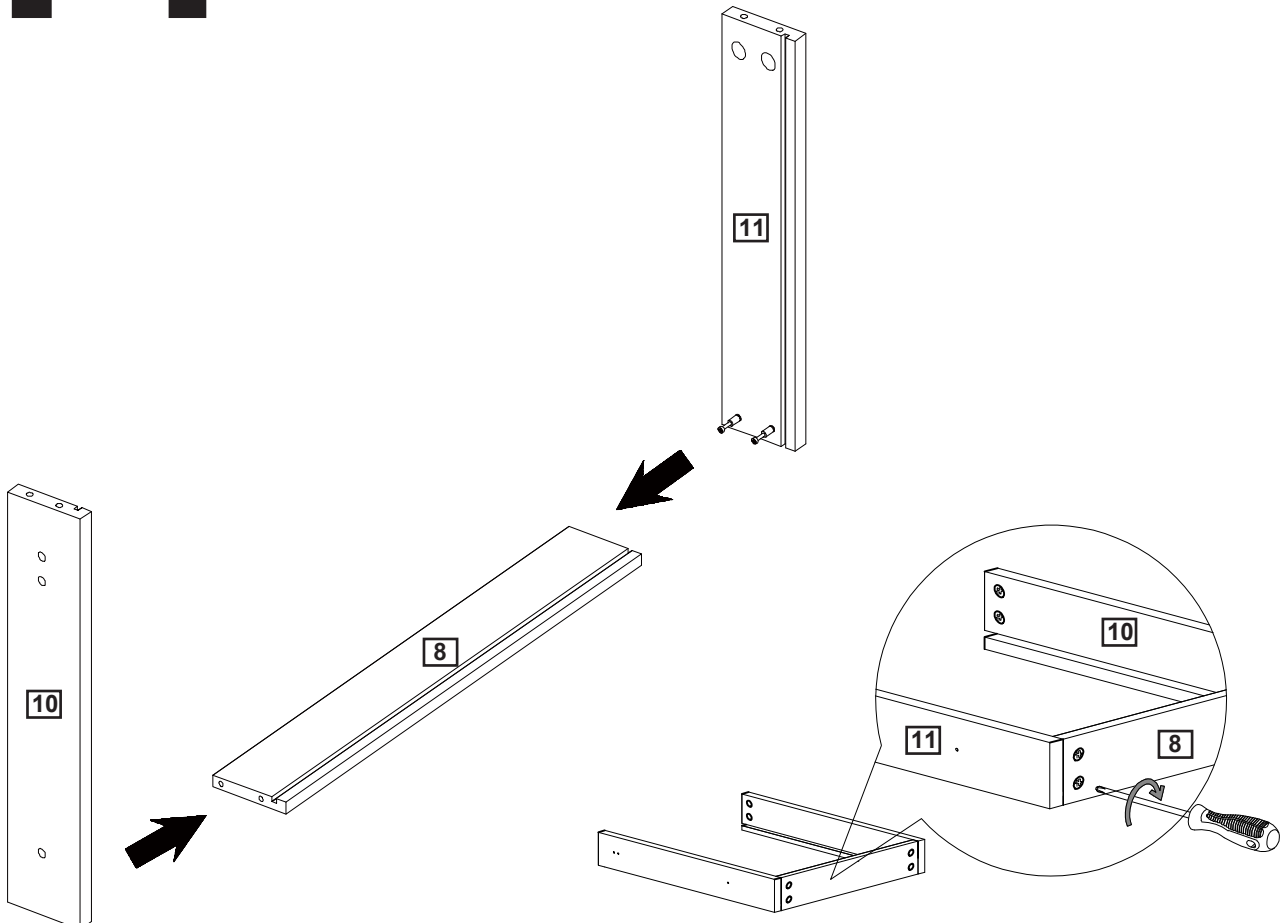
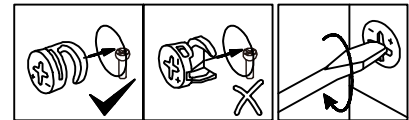

15

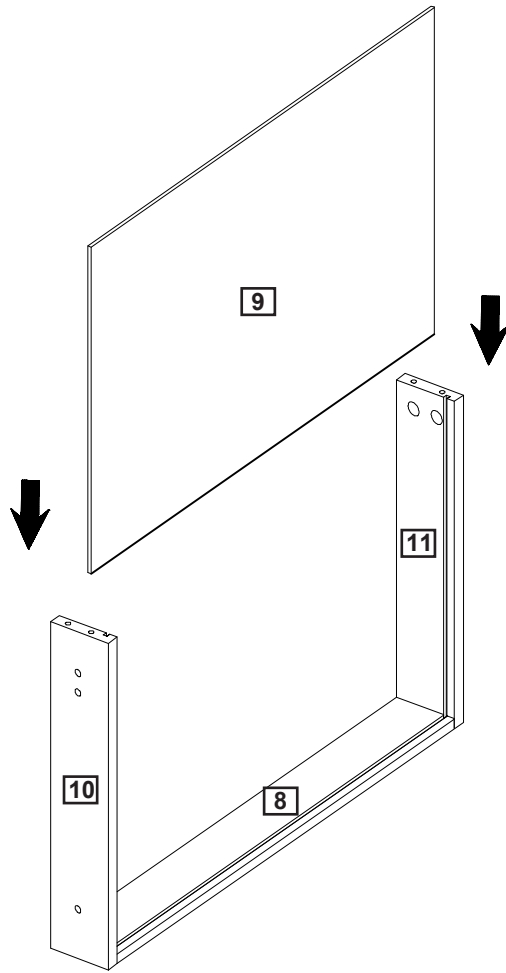

16

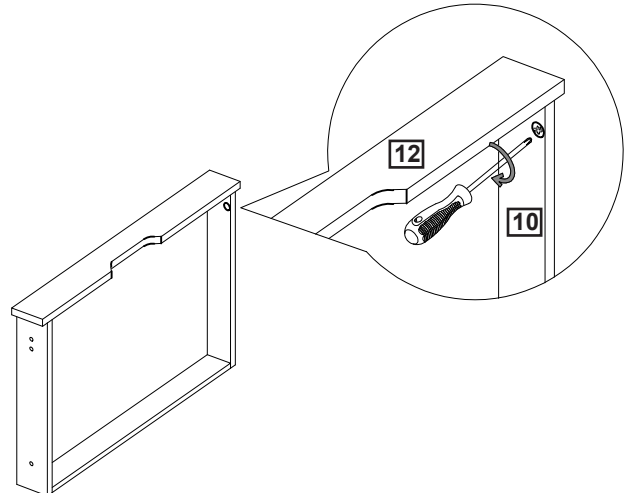
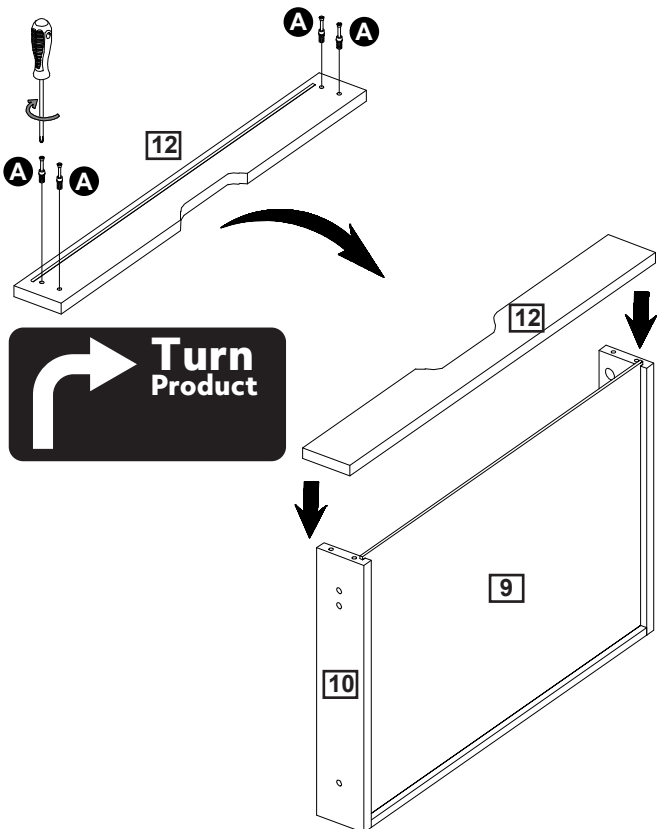
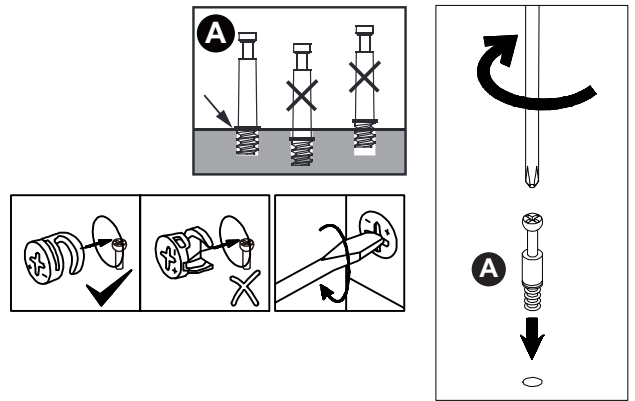
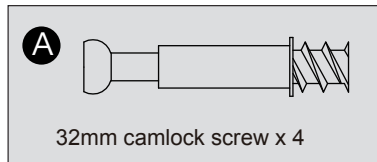

17

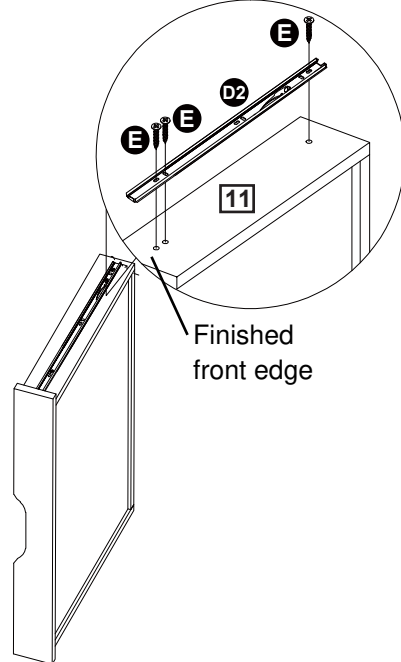
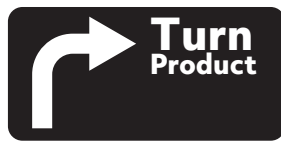
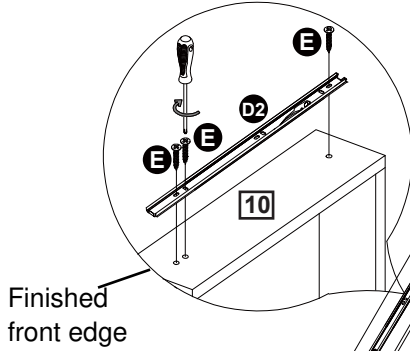
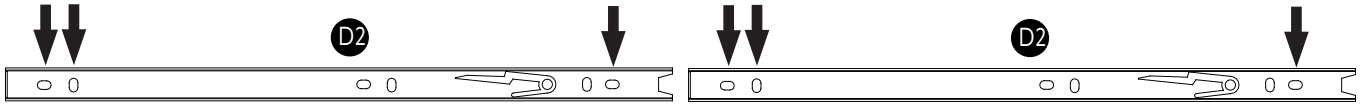
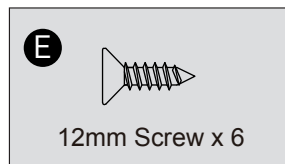
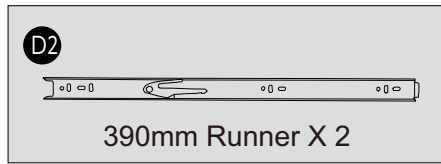

18

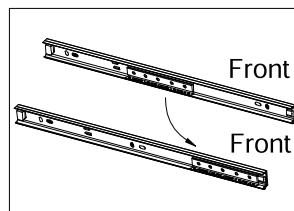
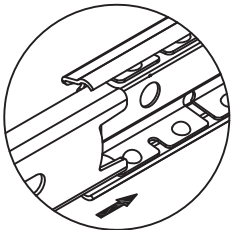
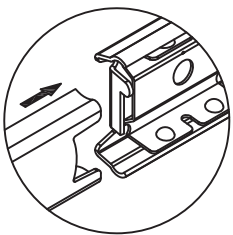

Note: Move the sliding part as shown below to the front end on both sides before inserting the drawer. This will assist for easier assembly.

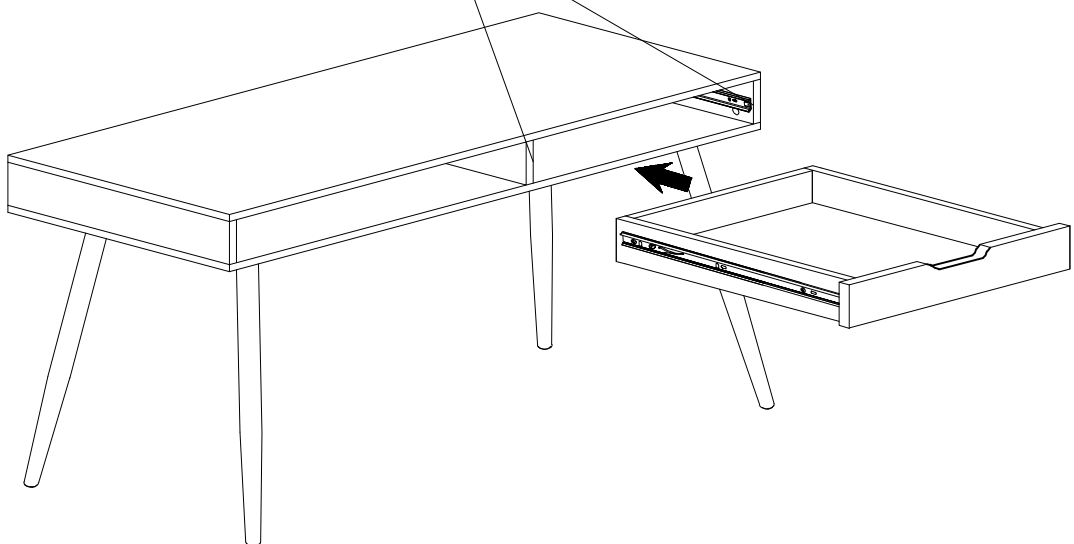

19

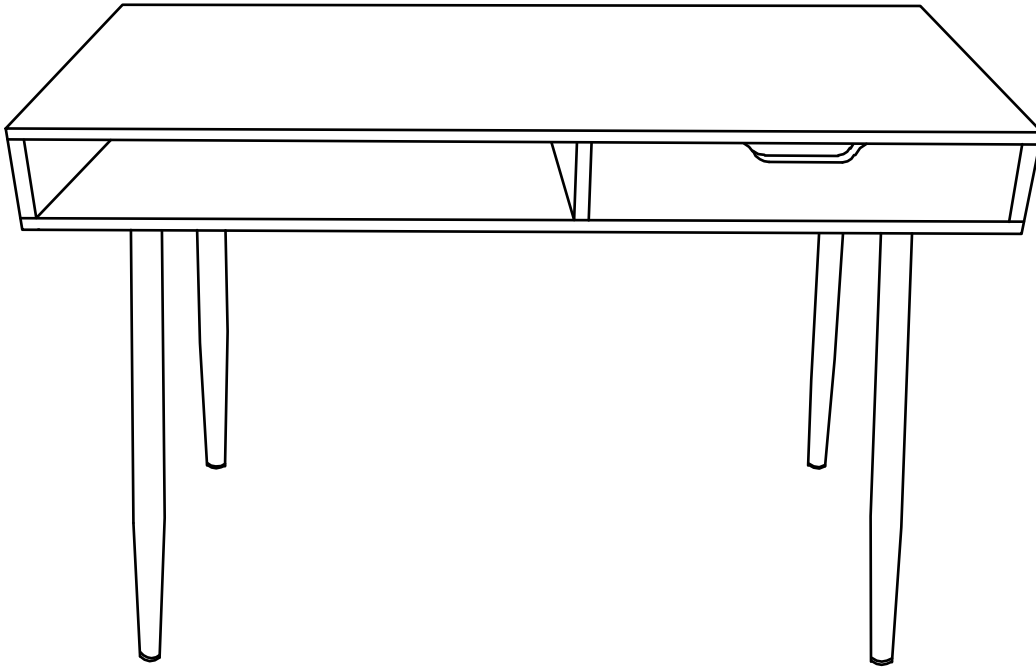

IMPORTANT

On a regular basis please check that the screws and fittings have not become loose as this could present a potential choke hazard.

Assembly is complete