

You should have these items

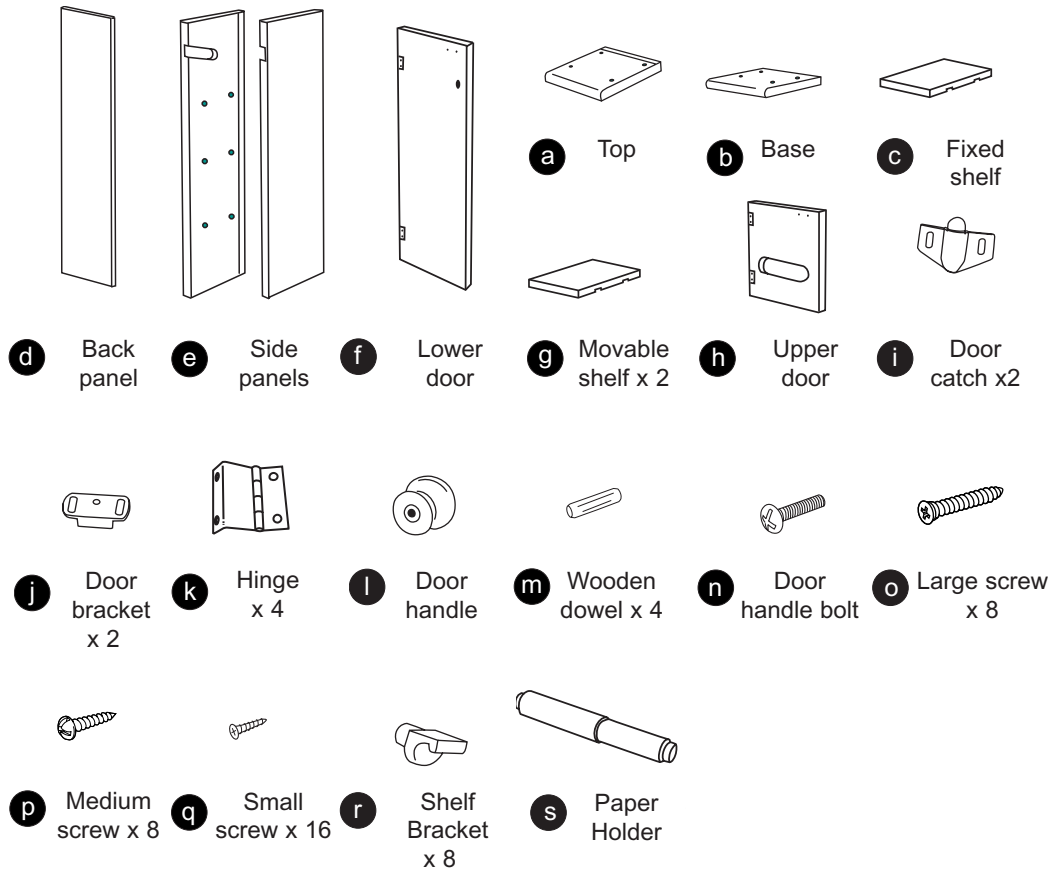

You will also need

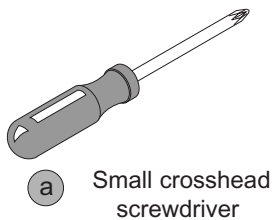

Tidy cupboard

Assembly instructions - Please read carefully

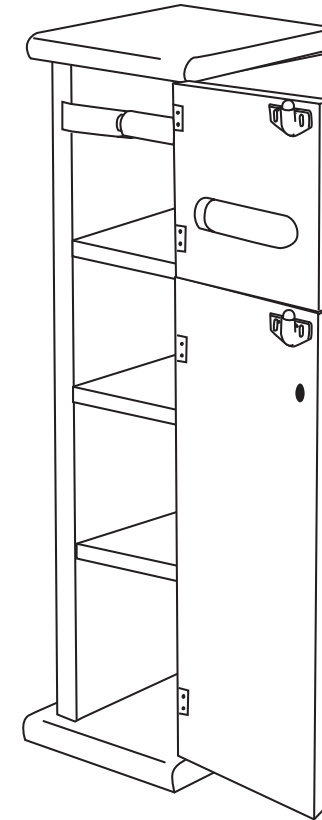

IMPORTANT

1. Read these instruction carefully and familiarise yourself with the procedure before assembling your Tidy Cupboard.
2. Please check that you have all the parts required these are listed on the back of this guide.
3. You will need a small crosshead screw driver to assemble this product.
4. To avoid damage, it is recommended that while you assemble your Tidy Cupboard it is placed on a soft, level surface.

Assembly instructions

Stage 1 - Assembling the body

1. Attach the door bracket to the underside of the fixed shelf using the medium screws. See fig 1.
2. Insert the doweling rods into the holes in the sides of the fixed shelf. See fig 1.
3. Use the doweling rods to fit the fixed shelf to the side panels. The shelf should attach to the upper set of holes. This may be a tight fit. See fig 2.
4. Lay the cupboard on its back and use four of the large screws to attach the base. See fig 3.
5. Slide the rear panel into the channels at the rear of the cupboard. See fig 4.
6. Attach a door bracket to the underside of the top using two medium screws. See fig 5.
7. Use the remaining four large screws to secure the top of the cupboard. See fig 6.

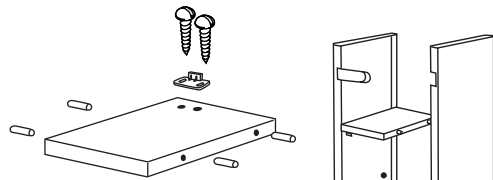

fig 1.

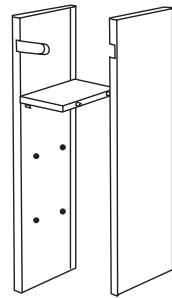

fig 2.

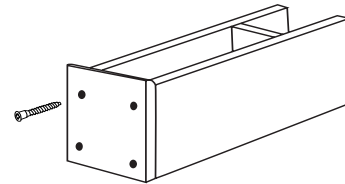

fig 3.

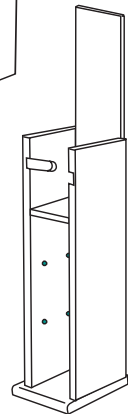

fig 4.

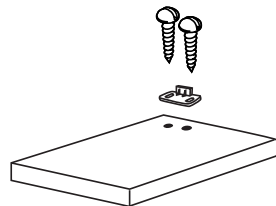

fig 5.

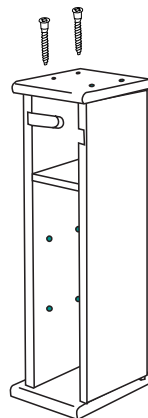

fig 6.

Assembly instructions

Stage 2 - Attaching the doors

8. Attach the fixed section of two hinges to the upper door using the small screws. Attach a door catch to the top, using two medium screws. See fig 7.
9. Do the same for the lower door. Remember to also attach the door handle using the door handle bolt. See fig 8.
10. Attach the doors to the main body of the cupboard using two small screws for each hinge. See fig 9.
11. Insert the shelf brackets in the holes in the side panels. See fig 10.
12. Place the shelves on the shelf brackets.
14. Insert the paper holder.
13. To finish the assembly of your tidy cupboard, insert the screw covers over the screw holes on the outside of the tidy cupboard, top and base. See fig 11.

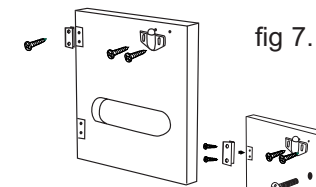

fig 7.

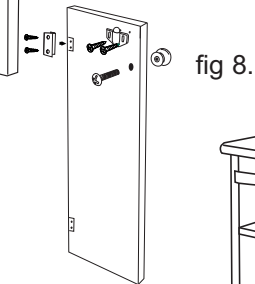

fig 8.

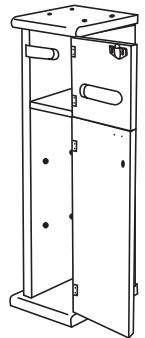

fig 9.

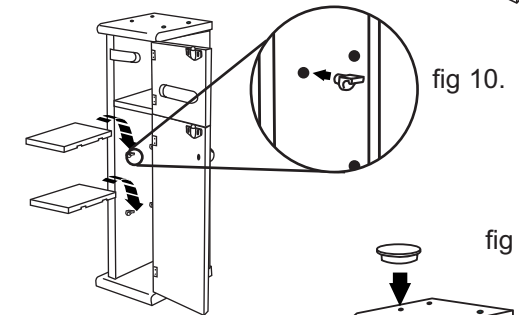

fig 10.

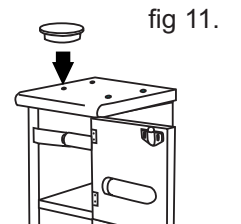

fig 11.

Safety Instructions

1. This Tidy Cupboard should be assembled by an adult.
2. Keep all small parts out of the reach of children.