

# LawnMaster®

## Instruction Manual

46cm 48V Lithium-Ion Cordless Mower CLMF4846A

CLMF4846A-01 (With 4 Batteries and 1 Charger)

CLMF4846A-1-01 (With 2 Batteries and 1 Charger)

CLMF4846A-BARE (Batteries and Chargers Not Included)

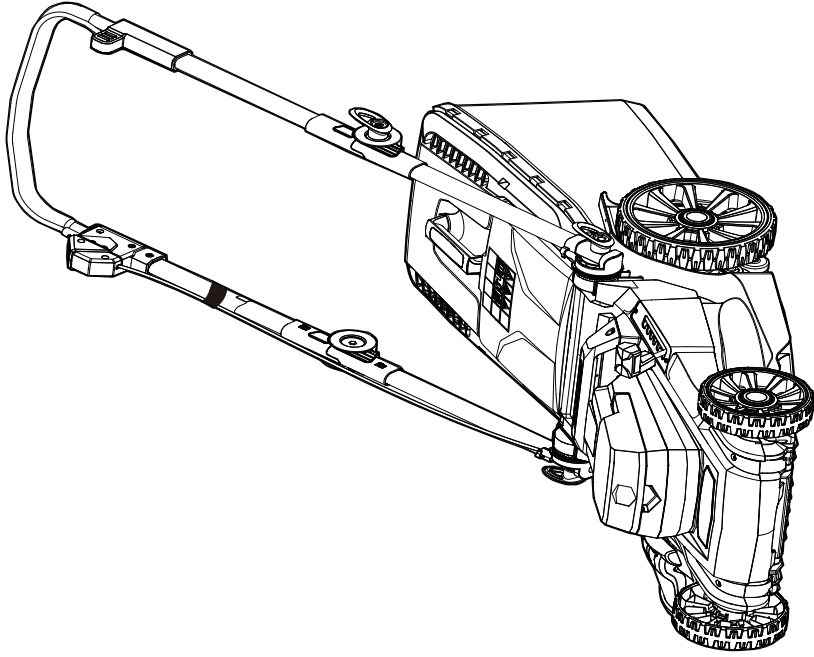

Original Instructions

 **WARNING:** Read all safety instructions carefully before assembling and operating this machine. Ensure the machine has been assembled correctly and safely. Keep the instructions safe and pass them on to any subsequent user so that the information is always available.



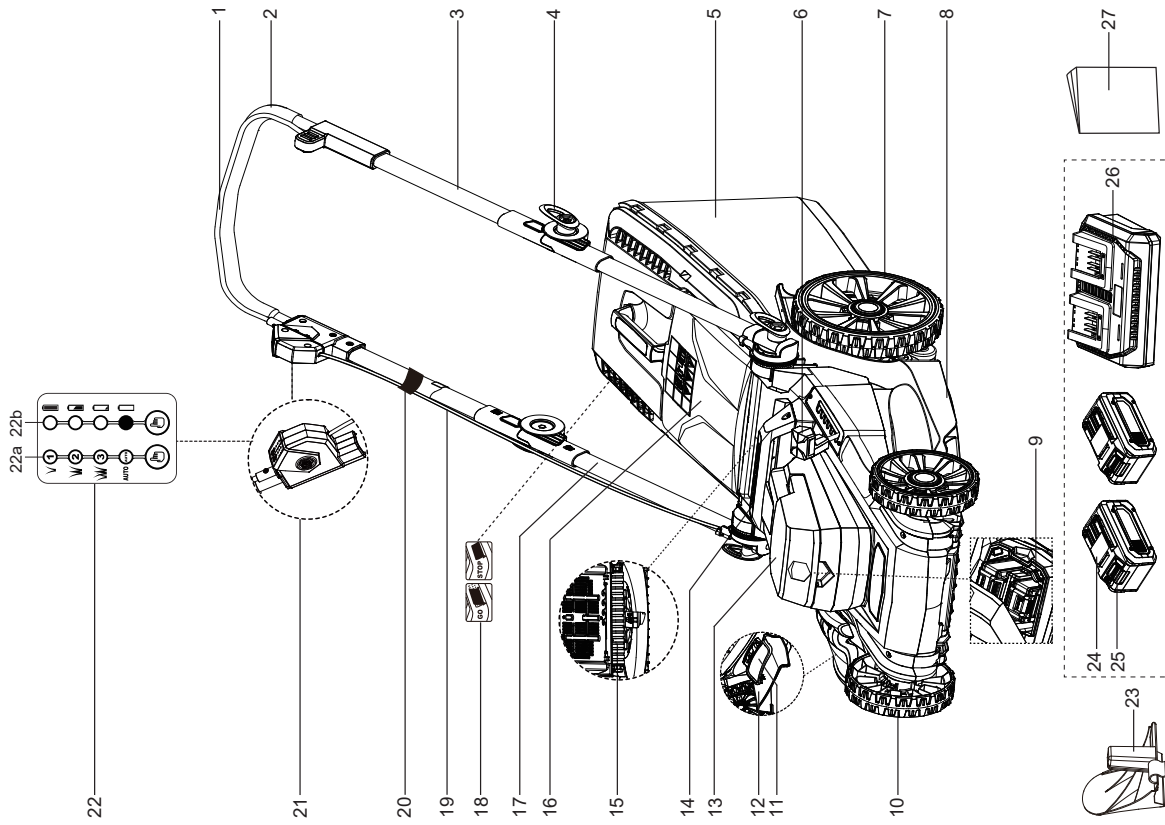
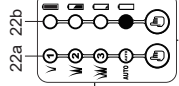

Not included with CLMF4846A-BARE

## TABLE OF CONTENTS



Section	Page
Symbols	6-7
Safety Information In the Box	8-20
Assembly	21
Operation	22-25
Maintenance	26-31
Troubleshooting	32-34
Technical Data	35-36
Recycling and Disposal	37
	38

## SYMBOLS

The following warning symbols appear throughout this manual and indicate the appropriate safety measures you should take when operating and maintaining the appliance.

SYMBOL	DESIGNATION/EXPLANATION
	Caution
	Read the instructions.
	<b>WARNING:</b> Beware of thrown objects. Keep bystanders away.
	<b>WARNING:</b> Disconnect battery before maintenance.
	Beware of sharp blades. Blades may continue to rotate after the motor is switched off. Beware of injury to toes or fingers.
	Switch off and remove the isolator key before adjusting, cleaning or before leaving the product unattended for any period.
	Wear eye and ear protection.
	Do not expose to rain.
	Wait until all moving parts have stopped completely before touching them. The blade may continue to rotate after the machine is switched off, a rotating blade can cause injury.
	<b>WARNING!</b> Beware of electric shocks.
	Cutting diameter
	Noise level specification LWA in dB(A)
	Protection class II (Double insulation)
	Only recharge battery packs with the supplied charger indoors.
	Fuse
	Electrical appliances must not be disposed of with the domestic waste.
	Batteries contain Lithium-ion. Do not dispose of batteries in household waste.
	Do not dispose of battery packs in rivers or immerse in water.

## SYMBOLS

SYMBOL	DESIGNATION/EXPLANATION
	Do not dispose of battery packs in fire.
	Do not subject the battery to direct sunlight over long periods and do not leave it on or near a heat source (max. 60°C).
	Recycle electrical waste products in an environmentally safe way where facilities exist.



### WARNING

To avoid serious personal injury, do not attempt to use this product until you read thoroughly and understand completely the instruction manual.  
If you do not understand the warnings and instructions in the instruction manual, do not use this product.

## SAFETY INFORMATION

### General Power Tool Safety Warnings



### WARNING

Read all safety warnings, instructions, illustrations and specifications provided with this power tool. Failure to follow all instructions listed below may result in electric shock, fire and/or serious injury.

Save all warnings and instructions for future reference.

The term "power tool" in the warnings refers to your mains-operated (corded) power tool or battery-operated (cordless) power tool.

- 1) Work area safety
  - a) Keep work area clean and well lit. Cluttered or dark areas invite accidents.
  - b) Do not operate power tools in explosive atmospheres, such as in the presence of flammable liquids, gases or dust. Power tools create sparks which may ignite the dust or fumes.
  - c) Keep children and bystanders away while operating a power tool. Distractions can cause you to lose control.
  - d) When the mower is running ensure that no person or pet, particularly children and animals, is in the immediate vicinity of the lawn mower. Ensure that you keep everybody at least 10 meters away from the mower when it is working.

## SAFETY INFORMATION

- 2) Electrical safety
- a) Power tool plugs must match the outlet. Never modify the plug in any way. Do not use any adapter plugs with earthed (grounded) power tools. *Unmodified plugs and matching outlets will reduce risk of electric shock.*
- b) Avoid body contact with earthed or grounded surfaces, such as pipes, radiators, ranges and refrigerators. *There is an increased risk of electric shock if your body is earthed or grounded.*
- c) Do not operate the lawnmower in rain or wet conditions. *This may increase the risk of electric shock.*
- d) Do not abuse the cord. Never use the cord for carrying, pulling or unplugging the power tool. Keep cord away from heat, oil, sharp edges or moving parts. *Damaged or entangled cords increase the risk of electric shock.*
- e) When operating a power tool outdoors, use an extension cord suitable for outdoor use. *Use of a cord suitable for outdoor use reduces the risk of electric shock.*
- f) If operating a power tool in a damp location is unavoidable, use a residual current device (RCD) protected supply. *Use of an RCD reduces the risk of electric shock.*
- 3) Personal safety
- a) Stay alert, watch what you are doing and use common sense when operating a power tool. Do not use a power tool while you are tired or under the influence of drugs, alcohol or medication. *A moment of inattention while operating power tools may result in serious personal injury.*

## SAFETY INFORMATION

- b) Use personal protective equipment. Always wear eye protection. *Protective equipment such as a dust mask, non-skid safety shoes, hard hat or hearing protection used for appropriate conditions will reduce personal injuries.*
- c) Prevent unintentional starting. Ensure the switch is in the off-position before connecting to power source and/or battery pack, picking up or carrying the tool. *Carrying power tools with your finger on the switch or energising power tools that have the switch on invites accidents.*
- d) Remove any adjusting key or wrench before turning the power tool on. *A wrench or a key left attached to a rotating part of the power tool may result in personal injury.*
- e) Do not overreach. Keep proper footing and balance at all times. *This enables better control of the power tool in unexpected situations.*
- f) Dress properly. Do not wear loose clothing or jewellery. Keep your hair and clothing away from moving parts. *Loose clothes, jewellery or long hair can be caught in moving parts.*
- g) If devices are provided for the connection of dust extraction and collection facilities, ensure these are connected and properly used. *Use of dust collection can reduce dust-related hazards.*
- h) Do not let familiarity gained from frequent use of tools allow you to become complacent and ignore tool safety principles. *A careless action can cause severe injury within a fraction of a second.*
- i) Never lift the lawn mower when you start the motor.
- j) Before you lift the lawn mower to transport it, switch off

## **SAFETY INFORMATION**

the motor, disconnect the mains lead and wait until the blade has come to a complete standstill.

- k) Never lift or carry the mower whilst the motor is running.
- l) Follow the instructions to fit or remove the blade and wear protective gloves.
- m) Never reach towards rotating parts with your hands or feet. *Always keep away from the discharge chute.*
- n) Never use the mower when you are tired.
- o) When you start the motor, the lawn mower should not be tilted unless the grass is particularly long. In this case only tilt it up as far as is really necessary and only raise the side that is furthest away from the user.
- p) Before you attach or empty the grass collection box, switch off the motor and wait until the blade has come to a complete standstill.
- q) Make sure you keep your feet at a safe distance from the mower blade at all times! *Do not stand near the grass ejection chute if the grass collection box is not fitted.*
- r) The safety distance from the moving blade produced by the push handle must be maintained at all times.
- s) If you use the mower on a small incline, mow across the slope (not in an up and down direction). *Always be sure of your footing on slopes.*
- t) Be particularly careful when changing direction with the mower whilst working on a slope.
- u) Do not use the lawn mower on gradients of over 15 degree.
- v) Ensure that you have safe footing at all times whilst working with the mower.

## **SAFETY INFORMATION**

- w) Always wear strong, anti-slip footwear and long trousers when using the mower. *Never mow in bare feet or in open-toed sandals.*
- 4) Power tool use and care
  - a) Do not force the power tool. *Use the correct power tool for your application. The correct power tool will do the job better and safer at the rate for which it was designed.*
  - b) Do not use the power tool if the switch does not turn it on and off. *Any power tool that cannot be controlled with the switch is dangerous and must be repaired.*
  - c) Disconnect the plug from the power source and/or remove the battery pack, if detachable, from the power tool before making any adjustments, changing accessories, or storing power tools. *Such preventive safety measures reduce the risk of starting the power tool accidentally.*
  - d) Store idle power tools out of the reach of children and do not allow persons unfamiliar with the power tool or these instructions to operate the power tool. *Power tools are dangerous in the hands of untrained users.*
  - e) Maintain power tools and accessories. Check for misalignment or binding of moving parts, breakage of parts and any other condition that may affect the power tool's operation. If damaged, have the power tool repaired before use. *Many accidents are caused by poorly maintained power tools.*
  - f) Keep cutting tools sharp and clean. *Properly maintained cutting tools with sharp cutting edges are less likely to bind and are easier to control.*

## SAFETY INFORMATION

- g) Use the power tool, accessories and tool bits etc. in accordance with these instructions, taking into account the working conditions and the work to be performed. *Use of the power tool for operations different from those intended could result in a hazardous situation.*
- h) Keep handles and grasping surfaces dry, clean and free from oil and grease. *Slippery handles and grasping surfaces do not allow for safe handling and control of the tool in unexpected situations.*
- i) This appliance is not intended for use by persons (including children) with reduced physical, sensory or mental capabilities, or lack of experience and knowledge, unless they have been given supervision or instruction concerning use of the appliance by a person responsible for their safety. *Children should be supervised to ensure that they do not play with the appliance.*
- j) Ensure that all the guards are securely fitted and in good working order.
- k) Check the grass collection box at regular intervals for signs of wear and to ensure that it is always in perfect working order.
- l) Before each use, inspect the mower to check the cutting blade, fastening bolts and the entire cutting unit for any signs of wear or damage. *To prevent imbalance or vibration, worn or damaged cutting blades and fastening bolts must always be replaced in full.*
- m) The user remains responsible for any injury to third parties within the working area of the lawn mower whilst the lawnmower is being used.

## SAFETY INFORMATION

- n) Only work in good daylight or appropriate and adequate artificial light.
- o) Never run the mower in enclosed or poorly ventilated rooms or if there are inflammable or explosive fluids, vapours or gases nearby.
- p) Switch off the mower if it has to be pushed over surfaces other than grass, and when moving the mower to and from the area you wish to mow.
- q) Carefully actuate the starter switch in accordance with the instructions.
- r) Do not switch the mower on and off frequently over a short period of time, and in particular do not play with the ON/OFF switch.
- s) Do not touch the cutting blade until the machine has been disconnected from the mains and the cutting blade has reached a complete standstill.
- t) Keep the lawn mower in a dry place which is inaccessible to children at all times.
- u) Do not leave the mower out in the rain. The lawn must not be wet or very damp.
- v) Be particularly careful when you change the direction of the mower or pull it towards you. *Avoid pulling it towards you while the blade is moving.*
- w) Only push the mower at a normal walking pace.
- x) Always use the lawn mower with the grass collection box correctly fitted.
- 5) Battery tool use and care
- a) Recharge only with the charger specified by the manufacturer. *A charger that is suitable for one type*

## SAFETY INFORMATION

of battery pack may create a risk of fire when used with another battery pack. Incorrect use may result in electric shock, overheating or leakage of corrosive liquid from the battery.

- b) **Use power tools only with specifically designated battery packs.** Use of any other battery packs may create a risk of injury and fire.
- c) **When battery pack is not in use, keep it away from other metal objects, like paper clips, coins, keys, nails, screws or other small metal objects that can make a connection from one terminal to another.** Shorting the battery terminals together may cause burns or a fire.
- d) **Under abusive conditions, liquid may be ejected from the battery; avoid contact.** If contact accidentally occurs, flush with water. If liquid contacts eyes, additionally seek medical help. Liquid ejected from the battery may cause irritation or burns.
- e) **Do not use a battery pack or tool that is damaged or modified.** Damaged or modified batteries may exhibit unpredictable behaviour resulting in fire, explosion or risk of injury.
- f) **Do not crush, drop or damage the battery pack.** Do not use a battery pack or charger that has been dropped or received a sharp blow. A damaged battery is subject to explosion. Properly dispose of a dropped or damaged battery immediately.
- g) **Do not expose a battery pack or tool to fire or excessive temperature.** Exposure to fire or temperature above 130 °C may cause explosion.
- h) **Do not place appliances or their batteries near fire or**

## SAFETY INFORMATION

heat sources. Continuous intense sunlight, fire or other heat sources may cause an increased danger of explosion. Batteries can explode in the presence of a source of ignition, such as a pilot light.

- i) **To reduce the risk of serious personal injury, never use any cordless product in the presence of an open flame.** An exploded battery can propel debris and chemicals. If exposed, flush with water immediately.
- j) **Do not charge battery in a damp or wet location.** Following this rule will reduce the risk of electric shock.
- k) **For best results, your battery tool should be charged in a location where the temperature is more than 4°C but less than 40°C.**
- l) **Under extreme usage or temperature conditions, battery leakage may occur.** If liquid comes in contact with your skin, wash immediately with soap and water. If liquid gets into your eyes, flush them with clean water for at least 10 minutes, then seek immediate medical attention.
- m) **Do not open up the battery and avoid mechanical damage to the battery.** Risk of short circuit and fumes may be emitted. Ensure fresh air and seek medical assistance in the event of discomfort.
- n) **Always remove battery pack before storing the device.** When battery becomes fully charged, unplug the charger from the power supply and remove the battery pack from the charger.
- o) **Keep battery pack dry, clean, and free from oil and grease.** Always use a dry cloth when cleaning. Never use brake fluids, gasoline, petroleum-based products, or any solvents to clean battery pack.

## SAFETY INFORMATION

- 6) Charger safety information
- a) Ensure the battery pack is charged indoors only, in a dry, cool and well-ventilated environment.
  - b) Do not use non-rechargeable batteries!
  - c) Do not operate the charger with a damaged cord or plug, which could cause shorting and electric shock. If damaged, immediately discontinue use. Replace the charger with the identical unit as listed in the Product Specifications in this manual. If the power cord for this equipment is damaged, it must be replaced by the manufacturer, a customer service agent of the same or a fully qualified person in order to prevent hazards.
  - d) **The plug of the charger must match the outlet.** Never modify the plug in any way. Unmodified plugs and matching outlets will reduce the risk of electric shock.
  - e) **Allow a hot battery to cool before charging.**
  - f) **Before each use, check the charger, cable and plug.** Do not use a defective charger and do not disassemble the charger. Incorrect reassembly may result in the risk of fire, electric shock or electrocution.
  - g) **Protect the charger against moisture and wet conditions.** There is a danger of electric shock.
  - h) **Operate the charger only with the appropriate original batteries.** Charging other batteries may result in injuries and risk of fire.
  - i) **Keep the cord away from heat, oil, sharp edges or moving parts.** Damaged or entangled cords increase the risk of electric shock.
  - j) **Do not use a charger that has been dropped or received a sharp blow.**

## SAFETY INFORMATION

- k) The voltage indicated on the charger rating plate must correspond to the voltage of the power source.
  - l) Never touch the mains plug with wet hands.
  - m) Follow all charging instructions and do not charge the battery pack or tool outside the temperature range specified in the instructions. *Charging improperly or at temperatures outside the specified range may damage the battery and increase the risk of fire.*
- 7) Service
- a) **Have your power tool serviced by a qualified repair person using only identical replacement parts.** *This will ensure that the safety of the power tool is maintained.*
  - b) **Never service damaged battery packs.** *Service of battery packs should only be performed by the manufacturer or authorized service providers.*
- Lawnmower safety warnings**
- a) **Do not use the lawnmower in bad weather conditions, especially when there is a risk of lightning.** *This decreases the risk of being struck by lightning.*
  - b) **Thoroughly inspect the area for wildlife where the lawnmower is to be used.** *Wildlife may be injured by the lawnmower during operation.*
  - c) **Thoroughly inspect the area where the lawnmower is to be used and remove all stones, sticks, wires, bones, and other foreign objects.** *Thrown objects can cause personal injury.*
  - d) **Before using the lawnmower, always visually inspect to see that the blade and the blade assembly are not**

## SAFETY INFORMATION

worn or damaged. Worn or damaged parts increase the risk of injury.

- e) **Check the grass catcher frequently for wear or deterioration.** A worn or damaged grass catcher may increase the risk of personal injury.
- f) **Keep guards in place. Guards must be in working order and be properly mounted.** A guard that is loose, damaged, or is not functioning correctly may result in personal injury.
- g) **Keep all cooling air inlets clear of debris.** Blocked air inlets and debris may result in overheating or risk of fire.
- h) **While operating the lawnmower, always wear non-slip and protective footwear. Do not operate the lawnmower when barefoot or wearing open sandals.** This reduces the chance of injury to the feet from contact with the moving blade.
- i) **While operating the lawnmower, always wear long trousers.** Exposed skin increases the likelihood of injury from thrown objects.
- j) **Do not operate the lawnmower in wet grass. Walk, never run.** This reduces the risk of slipping and falling which may result in personal injury.
- k) **Do not operate the lawnmower on excessively steep slopes.** This reduces the risk of loss of control, slipping and falling which may result in personal injury.
- l) **When working on slopes, always be sure of your footing, always work across the face of slopes, never up or down and exercise extreme caution when changing direction.** This reduces the risk of loss of control, slipping and falling which may result in personal injury.

## SAFETY INFORMATION

- m) **Use extreme caution when reversing or pulling the lawnmower towards you. Always be aware of your surroundings.** This reduces the risk of tripping during operation.
- n) **Do not touch blades and other hazardous moving parts while they are still in motion.** This reduces the risk of injury from moving parts.
- o) **When clearing jammed material or cleaning the lawnmower, make sure all power switches are off and the battery pack is disconnected.** Unexpected operation of the lawnmower may result in serious personal injury.
- p) **When clearing jammed material or cleaning the lawnmower, make sure all power switches are off and remove (or activate) the disabling device.** Unexpected operation of the lawnmower may result in serious personal injury.

### Intended Use

This lawn mower is designed for domestic use only:

- This cordless lawn mower is intended for mowing lawns in domestic and hobby gardens.
- This product is not to be used in wet weather conditions and may not be used to mow wet or unusually high grass.
- This product is intended for private domestic use only, not for any commercial trade use.

It must not be used for any purposes other than those described. Any use of the machine that deviates from its intended use and is not included in these instructions, is considered unauthorised use and relieves the manufacturer from his or her legal liability. This includes the use of unapproved accessories and replacement parts.

## IN THE BOX

- |   |                                     |                               |
|---|-------------------------------------|-------------------------------|
| 1. Start/Stop Bale Switch Lever                       | 10. Front Wheel                     | 21. Safety Button             |
| 2. Foam Grip  | 11. Side Discharge Door             | 22. iPower Control Panel      |
| 3. Upper Handle                                       | 12. Side Discharge Chute            | 22a. iPower Mode Indicator    |
| 4. Wing Knob (X4)                                     | 13. Battery Compartment Cover       | 22b. iPower Battery Indicator |
| 5. Grass Collection Bag                               | 14. Carry Handle                    | 23. Mulching Plug             |
| 6. Cutting Height Adjustment Lever                    | 15. Rear Roller                     | 24. Battery Pack*             |
| 7. Rear Wheel   | 16. Deflector Guard                 | 25. Battery Release Button    |
| 8. Deck   | 17. Lower Handle                    | 26. Battery Charger**         |
| 9. Isolator Key (Inside the Battery Pack Compartment) | 18. Grass Collection Full Indicator | 27. Instruction Manual        |
|   | 19. Control Cable                   |                               |
|   | 20. Cable Fasten Strap              |                               |

\* x4 Supplied with CLMF4846A-01

x2 Supplied with CLMF4846A-1-01

Not Supplied with CLMF4846A-BARE

\*\*Not Supplied with CLMF4846A-BARE

## ASSEMBLY

### Assembly Preparation

- Carefully remove all contents from the product packaging.
- Ensure you have all the accessories and tool(s) needed for assembly and operation. This also includes suitable personal protective equipment.



### WARNING

If any parts are damaged or missing do not operate this product until the parts are replaced. Failure to pay attention to this warning could result in serious personal injury.



### WARNING

Do not attempt to modify this product or create accessories not recommended for use with this product. Any such alteration or modification is misuse and could result in a hazardous condition leading to possible serious personal injury.



### WARNING

Do not connect the battery and/or the isolator key before the product is completely assembled. Failure to comply could result in accidental starting and possible serious personal injury.



### WARNING

Never operate the mower without the proper safety devices in place and in working order. Never operate the mower with damaged safety devices. Failure to pay attention to this warning can result in serious personal injury. Make sure all packing is removed from product parts before starting assembly.

### Assembling the Lower Handle (See Fig. 1)

- Unfold the lower handle and adjust to the desired operating position. There are three possible positions  (Fig. 1).
- Rotate the wing knobs clockwise to tighten (Fig. 1). Do not use excessive force; this may damage the knobs.

### Assembling the Upper Handle (See Fig. 2)

- Unfold the upper handle assembly.
- Align the upper handle and lower handle and secure with the wing knobs (Fig. 2).
- Ensure the cable is secured against the handle frame with the supplied cable fasten strap.

## ASSEMBLY

### Assembling the Grass Collection Bag (See Figs. 3-4)

Your mower comes with a tool free grass collection bag.

- Check the collection bag before assembling to make sure there is no damage.
- Insert the grass collection bag handle into the slots on the upper cover of grass collection bag. Make sure the arrow mark on the handle aligns with that on the cover of grass collection bag. Ensure this securely 'clicks' into place (Fig. 3).
- Secure the metal support rods into the fixing position on either side of the grass collection base. Ensure the side clamping sleeves are properly fixed onto the metal support frame (Fig. 4).
- There is a hole in the bottom of the grass collection bag to hang it up if required.

### Attaching/Removing the Grass Collection Bag (See Fig. 5)

**NOTE:** When using the grass collection bag, do not install the mulching plug. The mulching plug MUST be removed prior to installing the collection bag. The mulching plug is supplied fitted in the collection chute of the mower.

**NOTE:** The deflector guard is spring operated. Ensure you have a firm grip when opening and closing to avoid personal injury.

- Lift the deflector guard all the way up with one hand.
  - Lift the grass collection bag by its handle. Attach the grass collection bag onto the mounting brackets provided at the back of the lawnmower. Align the bottom of the grass collection bag first ensuring the collection tongue is located fully within the discharge chute of the lawnmower (Fig. 5).
  - Lower the deflector guard onto the grass collection bag.
  - To remove the grass collection bag, lift the deflector guard and unhook the grass collection bag from the mounting brackets. Carefully release the deflector guard back down.
- NOTE:** Under normal usage, bag material is subject to wear. To reduce the risk of injury, frequently inspect the bag assembly and replace if there are any signs of wear or deterioration.

### Grass Collection Full Indicator (See Figs. 6-7)

The grass collection full indicator is a small orange flap located on the side of the grass collection bag.

- If the grass collection bag is empty or partially full, the grass full indicator flap will remain open (Fig. 6).
- When this flap remains closed it means that the grass collection bag is full and needs to be emptied (Fig. 7).

### Attaching/Removing the Mulching Plug (See Figs. 8-10)



## WARNING

Do not at any time make any adjustment to the lawn mower without first stopping the motor and removing the isolator key and batteries.

## ASSEMBLY

**NOTE:** The mulching plug MUST be removed if collection bag is used during mowing operation.

The mulching plug prevents grass from being collected by blocking the collection chute. This allows the grass clippings to be deposited back on the lawn during cutting. This finely cut grass acts as a nutrient for the lawn.

### To install the mulching plug:

- Lift the deflector guard and detach the grass collection bag.
- Lift and hold the deflector guard up with one hand.
- With the other hand grasp the mulching plug by its upright handle and insert the plug into the rear discharge chute. Ensure that the locking latch snaps into place (Fig. 8 & 9).
- Release the deflector guard back into position during operation.

### To remove the mulching plug:

- Lift and hold the deflector guard up with one hand.
- With the other hand squeeze the mulching plug's upright handle to release the locking latch. Pull the mulching plug up and out of the discharge chute (Fig. 10).

### Installing the Side Discharge Chute (See Fig. 11)



## WARNING

Do not at any time make any adjustment to the lawn mower without first stopping the motor and removing the isolator key. Ensure the mulching plug is fitted when using the side discharge chute. Do not fit the collection bag.

The mower is designed to be able to disperse the clippings back to the lawn when the side discharge chute is fitted. Lift the side discharge door and insert the side discharge chute by mounting the support hook onto the metal spring frame. Release the door back down during operation (Fig. 11). This feature is optional and does not need to be fitted at all times.

### Installing/Removing the Battery Packs (See Fig. 12-13)



## WARNING

If any parts are broken or missing, do not attempt to attach the battery packs to the mower or operate the mower until the broken or missing parts are replaced. Failure to do so could result in serious injury. Do not connect the batteries and/or the isolator key before the product is completely assembled. Ensure the isolator key is not fitted before you install the batteries.

**NOTE:** Both batteries should be installed into the compartments in order to start the mower.

## ASSEMBLY

### To install the battery packs:

- Make sure both batteries are fully charged.
  - Lift the battery compartment cover on the lawnmower deck.
  - Align the support rails located within the battery compartment with the guides in the battery pack, and then insert the battery packs into the compartment (Fig. 12).
  - Push the battery packs until you hear a "click".
  - Insert the isolator key into the keyholes located within the battery compartment.
  - Close the battery compartment cover.
- NOTE:** Make sure that battery packs firmly snap into place and are secured to the mower before starting operation.

### To remove the battery packs:

- Stop the machine. Lift the battery compartment cover and remove the isolator key.
- Press the release button on the battery pack, grasp the battery pack firmly and pull out of the battery compartment. Remove the second battery in the same way (Fig. 13).
- Close the battery compartment cover.

## OPERATION

### **WARNING**

Do not allow familiarity with this type of product to make you careless. Always pay attention when operating this product, not doing so can result in serious injury.

### **WARNING**

Always wear safety goggles or safety glasses with side shields when operating this product. Failure to do so could result in objects being thrown into your eyes, resulting in possible serious injury.

### **WARNING**

Do not use any attachments or accessories not recommended by the manufacturer of this product. The use of attachments or accessories not recommended can result in serious personal injury.

### Setting the Cutting Height (See Fig. 14)

### **WARNING**

Switch off the equipment, remove the isolator key and wait for the blade to come to a complete stop before adjusting the cutting height. A rotating blade can cause injury. Keep your feet away from the deck when adjusting its height.

Before using the mower for the first time, adjust the cutting position to the height best suited for your lawn.

The mower can be set to 6 cutting heights between 25mm and 75mm. Choose the appropriate cutting height according to the types and conditions of the grass.

POSITION	CUTTING HEIGHT
1	25mm
2	35mm
3	45mm
4	55mm
5	65mm
6	75mm

### To set the cutting height:

- To raise the cutting height, grasp the cutting height adjustment lever, disengage the lever from its current setting, and then move it towards the back of the mower and engage the lever in the desired cutting height position (Fig. 14).
- To lower the cutting height, grasp the cutting height adjustment lever, disengage the lever from its current setting, and then move it towards the front of the mower and engage the lever in the desired cutting height position (Fig. 14).

## OPERATION

For the first cut each season, a higher cutting setting should be selected. Using a cutting height that is too low in longer grass will use more power and reduce battery run time. It is recommended to cut longer grass in 2 passes or more. This method will also cause less stress to your grass for a healthier lawn.

Before you begin to mow, check to ensure that the blade is not blunt and that none of the fasteners are damaged. To prevent any imbalance, replace blunt and/or damaged blades. To carry out this check, first switch off the motor and remove the batteries and isolator key.

### Battery Pack Operation

- Battery Charging



## WARNING

Use only with 24LFC19 battery charger approved by the manufacturer.



## CAUTION

Please fully charge before first use.

The battery charger supplied is specifically designed for the lithium-ion battery used in this garden appliance and may cause risk of fire if used with a non-compatible battery pack.

Check the power voltage! Battery chargers operate on 220-240V AC.

Ensure the batteries are charged between 4°C and 40°C. This ensures an optimum battery service life.

Protect the batteries from heat, from continuous exposure to sun and keep away from radiation or other heat sources. Do not leave the batteries in the mower in direct sunlight over long periods. The batteries are supplied partially charged. To ensure full capacity of each battery, charge the batteries before using your appliance for the first time. The lithium-ion batteries can be charged at any time without reducing their service life. Interrupting the charging procedure does not affect the batteries.

- Battery LED Indicators

The panel consists of 3 LEDs on the battery. Press and hold the button, then release it, the LEDs will show you the charge levels.

The battery's charge level can be checked either when the battery is attached on the charger/mower or removed from the charger/mower.

### Indicator Lights

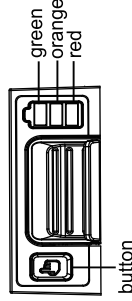

## OPERATION

LEDs on Battery (Continuous Lighting)	Battery Capacity
3 LEDs (inc green)	Fully charged
2 LEDs (orange & red)	≥40%
1 LED (red only)	< 40%. Recharge required.

### Charger Operation (See Fig. 15)



## WARNING

Use only with the following battery approved by the manufacturer: 24LB2004-CN, 24LB4005-CN, 24LB8006-CN.

If any part of the charger is missing or damaged, do not operate it! Replace the charger with a new one. Failure to pay attention to this warning could result in possible serious injury.

Check the voltage! The voltage must comply with the information on the rating label.

- Align the slot of the battery pack with the rail on the charger. Slide the battery onto the rail until the battery pack secures into place (Fig. 15).
- Connect the charger to the power supply.
- Allow sufficient charging time (see Technical Data), and then disconnect the charger from the power supply.
- Press the release button on the battery pack and remove it from the charger.

**NOTE:** It is normal for the battery pack and the charger to become warm (but not hot) during charging process. If the battery does not charge properly, check to make sure the electrical outlet is operational. Always charge the battery before storage!

### The indicator lights on the charger show the charging status:

Symbol	Indicator lights		Status
		Red, flashing	Charging paused, see instructions below.
		Red, continuous	Connected to power supply (Standby)
		Green, flashing	Charging
		Green, continuous	Fully charged

## OPERATION

The intelligent charger measures the charge level of the battery pack and charges the battery accordingly with the required current and voltage, based on battery temperature and voltage, this ensures maximum battery life. Charge the battery fully before storage.

A flashing red LED light on the charger indicates that the battery temperature is not within the charging temperature range of 4°C - 40°C. As soon as the permitted temperature is reached, the battery charger will automatically switch to charging.

If the temperature range is correct and flashing red LED light continues, then remove and reinstall the battery pack. If the LED status repeats a second time, try to charge another identical battery. If the battery charges normally, dispose of the defective battery pack (see Recycling and Disposal section).

If the flashing red light continues after installing the second battery (ensure the battery temperature is normal), the charger may be defective. Replace with a new one. After continuous or repeated charging cycles without interruption, the charger may warm up. This is normal and does not indicate a technical defect of the battery charger.

### Starting/Stopping the Mower (See Figs. 16-17)



The blade may keep rotating for a few seconds after the device has been switched off. Do not touch the rotating blade. A rotating blade can cause injury.

- To switch on, insert the isolator key located within the battery compartment. Press and hold the safety button and gently pull the start/stop bale switch lever towards the upper handle (Fig. 16 & 17). Once started, release the safety button.
- To power off the mower, release the start/stop bale switch lever.
- Remove the isolator key if the mower is not going to be used immediately.

### iPower Mode Indicator (See Fig. 18)

Push the button repeatedly to cycle through the different motor power output levels (Fig. 18). By default, the mower power is set to "AUTO".

Mode Indicator on Panel	Motor Power Output Level	Runtime
AUTO	Automatically adjust to suit your lawn conditions.	Balanced Runtime
1	Lawn needs only light mowing.	Maximum Runtime
2	Mow taller and thicker grass.	Medium Runtime
3	Maximum motor power output, mow the most stubborn grass.	Minimum Runtime

## OPERATION

### iPower Battery Indicator (See Fig. 18)

- Push the button to check on the battery status.
- The number of lights it will depend on the condition of the battery.
- 4 lights indicate a fully charged battery, 1 light indicates the battery needs to be charged (Fig. 18).



A flashing LED on the mower mode control panel indicates that the current is too high. A flashing LED on the battery indicates that the voltage is too low. In either case the motor will shut down automatically. Do not continue to activate the On/Off switch if the motor has been shut down automatically. The battery may be damaged.

### General Operation

Check the product and accessories for damage before each use. Before use, ensure all power connections are in good working order prior to installing batteries and the isolator key. If damage is present or observed, stop and have mower serviced before use. Do not use the product if it is damaged.

- Double check that the blade is properly installed.
- Always hold the product by its operation handles. Keep handles dry to ensure safe support.
- Ensure that air vents are always unobstructed and clear. Clean them if necessary with a soft brush. Blocked air vents may lead to overheating and damage to the product.
- Switch the product off immediately if you are disturbed while working by other people entering the working area.
- Always let the blade come to a complete stop before removing the grass collection bag.
- Do not overwork yourself. Take regular breaks to ensure you can concentrate on the work and have full control over the product.

### Mowing (See Figs. 19-20)

- Make sure the lawn is clear of stones, sticks, wires, and other objects that could damage the lawnmower blades or motor. Such objects could be accidentally thrown by the mower in any direction and cause serious personal injury to the operator and others.
- When cutting thick grass, reduce walking speed in order to allow for a more effective cut and a proper discharge of the clippings.
- Never cut off more than one-third of the total length of the grass for a healthy lawn. If it is roughly 6cm long, the grass should not be shorter than 4cm once mowed. If the grass is higher, you should gradually cut it down to the desired length so as not to damage the grass. Cutting grass that is too long will result in poor collection performance and may overload the motor.
- Do not cut wet grass as it can stick to the lawnmower and prevent the proper discharge of grass clippings.

## OPERATION

- Clean the underside of the mower deck after each use to remove grass clippings, leaves, dirt, and any other accumulated debris.
- Slopes are a major factor related to slip and fall accidents that can result in severe injury. Mowing on slopes requires extra caution. If you feel uneasy on a slope, do not mow it. For your safety, do not attempt to mow slopes greater than 15 degrees.
- Mow across the face of slopes, not up and down. Exercise extreme caution when changing direction on slopes.
- Watch for holes, ruts, rocks, hidden objects, or bumps which can cause you to slip or trip. Tall grass can hide obstacles. Remove all objects such as rocks, tree limbs, etc., which could be tripped over or thrown by the blade.
- Always be sure of your footing. A slip and fall can cause serious personal injury. If you feel you are losing your balance, release the switch lever immediately.
- Do not mow near drop-offs, ditches, or embankments; you could lose your footing or balance.
- We recommend that you mow in overlapping lines for effective grass collection. This will keep the rows even and ensures that all the lawn is cut without missing any spots (Fig. 19).
- The rear roller leaves a striped finish on the lawn and helps to prevent scalping on borders and edges (Fig. 20).

## MAINTENANCE

### **WARNING**

If a part becomes worn or damaged, use recommended manufacturers replacement parts. Use of any other parts may create a hazard or cause product damage.

### **WARNING**

Always switch the product off, remove the isolator key and the battery packs and let the product cool down before performing inspection, maintenance and cleaning work!

### **WARNING**

Do not use any attachments or accessories not recommended by the manufacturer of this product. The use of attachments or accessories not recommended can result in serious personal injury.

### **General Maintenance**

- Keep all safety devices, air vents and the motor housing free of dirt and dust. Avoid using solvents when cleaning plastic parts. Most plastics are susceptible to damage from various types of commercial solvents and may be damaged by their use. Use clean, dry cloths to remove dirt, dust, oil, grease, etc.
- Periodically check all nuts and bolts for proper tightness to ensure safe operation of the mower.
- Remove any buildup of grass and leaves on or around the motor cover. Wipe the mower clean with a dry cloth occasionally. Do not use water as this may damage any electrical components.
- The underside of mower deck should be cleaned after each use as grass clippings, leaves, dirt and other debris may accumulate causing rust and corrosion.

### **WARNING**

Always wear protective, heavy gloves and/or wrap the cutting edges of the blade with rags when performing blade maintenance. Failure to pay attention to this warning could result in serious personal injury.

### **WARNING**

Before performing any maintenance, make sure the isolator key and the batteries have been removed. Failure to heed this warning could result in serious personal injury.

## MAINTENANCE

### Replacing the Blade (See Figs. 21-22)

**NOTE:** Remove the isolator key and batteries before performing any maintenance.

**NOTE:** If the blade is blunt, damaged or showing signs of imbalance, it must be replaced. Use recommended replacement blade.

- Stop the motor and allow the blade to come to a complete stop.
- With blade stopped, remove the ISOLATOR KEY and BATTERIES from mower and store in a safe location.
- Remove the grass collection bag from mower if attached.
- Slowly turn the mower on its side.
- Wedge a block of wood between the blade and the mower deck, or use safety gloves to firmly hold the blade, in order to prevent the blade from turning when the blade nut is being removed.
- Loosen the blade nut using a wrench or socket (not provided).
- Remove the blade nuts anticlockwise, and then remove the blade (Fig. 21).
- Remove the insulation cap cover on the blade carrier. Loosen and remove the blade carrier bolt. Replace the blade carrier bolt with the new bolt supplied in the official blade replacement kit. If not replacing the bolt always apply Loctite 243 thread locker to the last 5 - 7 threads of the bolt. Fasten the carrier bolt and tighten to 16 Nm. Place the insulation cap cover over the bolt and fix in place with the retaining clip.
- Place the new blade on the blade carrier. Make sure it is installed with the curved ends pointing up towards the mower deck and not down towards the ground (Fig. 22).
- Thread the new blade nuts on the blade carrier and finger tighten.
- If not using the official replacement blade kit application of Loctite 243 on to the last 5 – 7 threads of the bolt is required. Torque the blade nuts down using a torque wrench (not provided) to 25 Nm to ensure the bolt is properly tightened.

**NOTE:** Make certain all parts are replaced in the exact order in which they were removed.

### Sharpening the Blade (See Fig. 23)

For best mowing performance, the mower blade must be kept sharp. A dull blade does not cut grass evenly and overloads the motor. If your lawn has sandy soil, more frequent sharpening may be required.

- Following the instructions in the "Replacing the Blade" section to remove the mower blade. DO NOT attempt to sharpen the blade while it is attached to the mower.
- Using a fine-tooth file or sharpening stone, sharpen cutting edges on both ends of the blade, removing equal amounts of material from both ends (Fig. 23).

## WARNING

When removing, inspect the blade carefully. If the blade is bent or damaged, replace immediately with a new blade. Failure to replace a bent or damaged blade could cause an accident resulting in possible serious injury.

### Balancing the Blade (See Fig. 24)

When sharpening, care should be taken to keep the blade balanced. An unbalanced blade will cause excessive vibration when the mower is running. This vibration will eventually cause damage to the mower, especially the motor.

## MAINTENANCE

### To check the blade balance:

- Clamp a screwdriver horizontally in a vise as shown.
- NOTE:** If a vise is not available, a straight nail can also be used.
- Place the center hole of blade on the screwdriver (or nail) shank.
- If blade is balanced, it will remain in a horizontal position. If either end of the blade drops downward, sharpen the heavy side until the blade is balanced.

### Storing the Mower (See Figs. 25-26)

The device features the following storage options to save space:

- Before storing your mower, remove the isolator key and the batteries.
- Release the upper and lower wing knobs on both sides of the handle bars.
- Fold the upper handle and lower handle assembly over the device housing. Making sure that the cables do not become trapped (Fig. 25).
- Store the mower flat or upright (Fig. 26).
- Store the mower indoors in a cool, dry location and out of reach of children.
- Allow the motor to cool before storing the equipment in a confined space.
- Do not cover the equipment as moisture could build up.

### Battery and Charger Maintenance

- Keep the batteries and charger clean and clear of debris. Do not allow foreign material into the recessed cavity or on the contacts. Wipe with a dry cloth. Do not use solvents, water, or place in wet conditions.
- Always unplug the charger when there is no battery pack in it.
- Check that the charger and battery contacts have not been shorted by debris or foreign material. Always store away from metal objects which could create a connection with the terminals.
- Always remove the batteries when storing the mower and keep in a cool dry place out of direct sunlight.
- Store the batteries only within a temperature range between 0°C and 25°C and do not subject or store the battery packs to direct sunlight.
- It is recommended to store the lithium-ion battery packs in a 30%-50% charged condition.
- It is recommended to fully charge the lithium-ion battery packs after every six months of storage.

## TROUBLESHOOTING



### WARNING

Only perform the steps described within these instructions! All further inspection, maintenance and repair work must be performed by a qualified specialist.  
Gloves and appropriate protective clothing must be worn when performing these instructions.  
Always turn off the machine and disconnect the plug and wait until the blade stops before making any adjustment.

PROBLEM	POSSIBLE CAUSE	SOLUTION
Mower fails to operate.	The isolator key is not installed correctly/fully.	Install the isolator key correctly.
	The batteries are not installed correctly.	Ensure the batteries are correctly installed.
	The batteries are not fully charged.	Charge the batteries.
	Possible clogging.	Remove the isolator key and batteries. Check underneath the mower and clear as necessary (always wear gardening gloves).
	The grass is too long.	Increase the height of cut and tilt garden product to reduce the starting load.
	The batteries are too hot/cold.	Allow the batteries to cool/warm to room temperature.
	The batteries are defective.	Replace the batteries.
	There is a short delay in the motor starting after engaging the switch lever.	This is normal. Hold the switch lever for 1-3 secs to start the motor.
	The batteries are not fully charged.	Charge the batteries.
	The isolator key is not installed correctly/fully.	Install the isolator key correctly.
Motor starts and stops immediately.	The batteries are not installed correctly.	Ensure the batteries are correctly installed.
	The batteries are too hot/cold.	Allow the batteries to cool/warm to room temperature.
Mower functions intermittently.	Motor protector has activated.	Allow the motor to cool and increase the height of cut.

## TROUBLESHOOTING

Lawnmower leaves ragged cut.	Height of cut is too low.	Increase the height of cut.
	Cutting blade is blunt.	Replace the blade.
Mower does not mulch properly.	Wet grass clippings are sticking to the underside of the deck.	Wait until the grass dries before mowing.
	Missing mulching plug.	Install the mulching plug.
Poor cutting or motor labours.	Possible clogging.	Check underneath the mower and clear out as necessary (always wear gardening gloves).
	The blade is fitted upside down.	Refit the blade correctly.
	Height of cut is too low.	Increase the height of cut and walk slower.
	The grass is too high.	Increase the height of cut and walk slower.
Area of cut (battery duration) is not large enough.	The grass is wet or damp.	Wait until the grass is dry and walk slower.
	The grass is dense.	Increase the height of cut, walk slower and cut more frequently.
	The cutting blade is obstructed.	Switch off the mower and clear obstruction (always wear gardening gloves).
	The blade nut/bolt is loose.	Tighten the blade nut/bolt (17 Nm).
The cutting blade is not rotating while the garden product is switched on.	Belt is slipping or snapped.	Contact the aftersales helpline.
	The blade nut/bolt is loose.	Tighten the blade nut/bolt (17 Nm).
Excessive vibrations/noise.	Cutting blade is damaged.	Replace the blade.
	The battery contacts are contaminated.	Clean the battery contacts (e.g. by inserting and removing the battery several times) or replace the battery.
No charging procedure possible.	Socket outlet, fuse, mains cable or battery charger are defective.	Check the mains voltage and fuse, if necessary, contact aftersales helpline.
	The battery has a fault.	Replace the battery.
The charge control LEDs do not light up after inserting the mains plug into the socket.	Mains plug of the battery charger is not plugged in (properly).	Insert mains plug fully into the socket outlet.
	Socket outlet, mains cable or battery charger are defective.	Check the mains voltage and if necessary, contact aftersales helpline.

## TECHNICAL DATA

### 48V Cordless Mower CLMF4846A

Voltage	48V
No Load Speed	3200-3300-3400/min
Cutting Width	46cm
Cutting Height Adjustment	25/35/45/55/65/75mm (6 Positions)
Grass Collection Box Capacity	60L
Functions	4-in-1: Mulch, Rear Bag, Rear Discharge, Side Discharge
Wheel Size	170/235mm
Protection Type	IPX4
Sound Pressure Level (LPA)	80.1dB(A) K=3dB
Sound Power Level (LWA) Guaranteed	96dB(A)
Sound Power Level (LWA) Measured	89.7dB(A) K=2.14dB
Vibration (ah)	≤2.5m/s <sup>2</sup> K=1.5m/s <sup>2</sup>
Weight (Without 4.0Ah Batteries)	16.47kg

### CHARGER

Model No.	24LFC19
Charger Input	220-240V~50-60Hz 230W
Charger Output	24V --- Max 6.0A(each port) / Max 8A(total)
Charging Period (Battery Fully Discharged)	50min (for one 24LB4005-CN) 60min (for two 24LB4005-CN)
Weight of Charger	0.9kg
Insulation Protection of Charger	<input checked="" type="checkbox"/>

### BATTERY

Model No.	24LB4005-CN
Rated Voltage of Battery	24V ---
Capacity of Battery	4.0Ah
Battery Type	Lithium-Ion
Weight of Battery	0.7kg

## RECYCLING AND DISPOSAL



This marking indicates that this product should not be disposed with other household wastes. The machine must be delivered in rigid packaging to avoid damage during transportation. The packaging and the machine itself are manufactured from recyclable materials and should be disposed of accordingly.



This appliance contains Lithium-ion battery. Do not dispose of batteries in household waste, fire or water. Dispose of batteries in accordance with the local regulations where they will be recycled in an environmentally friendly manner.

Li-ion

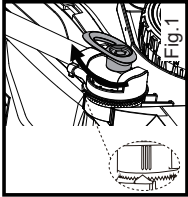

Fig. 1

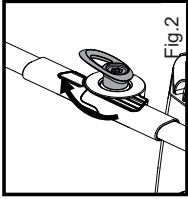

Fig. 2

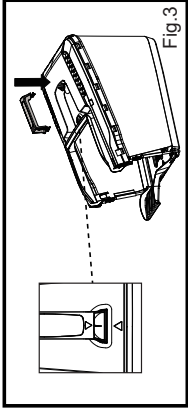

Fig. 3

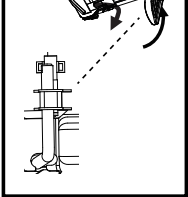

Fig. 4

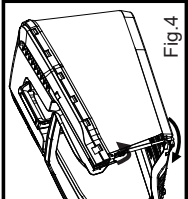

Fig. 5

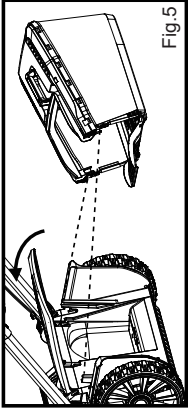

Fig. 6

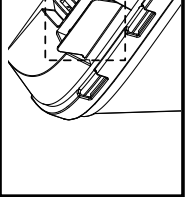

Fig. 7

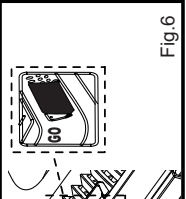

Fig. 8

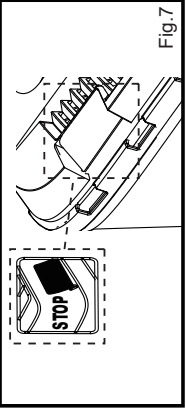

Fig. 9

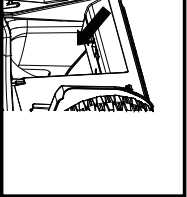

Fig. 10

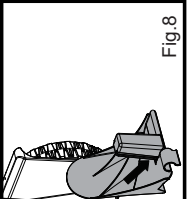

Fig. 11

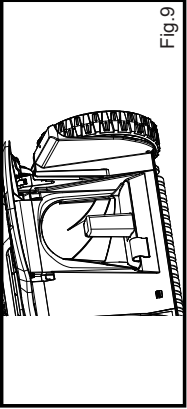

Fig. 12

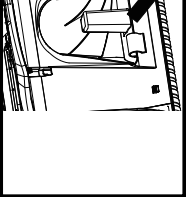

Fig. 13

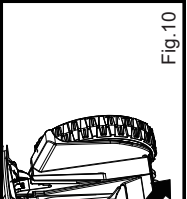

Fig. 14

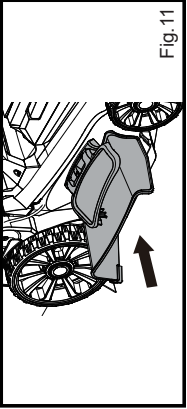

Fig. 15

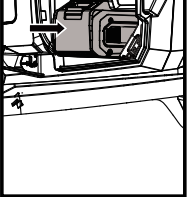

Fig. 16

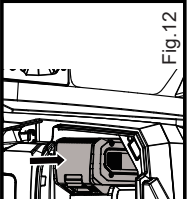

Fig. 17

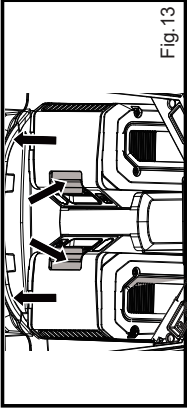

Fig. 18

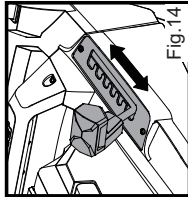

Fig. 19

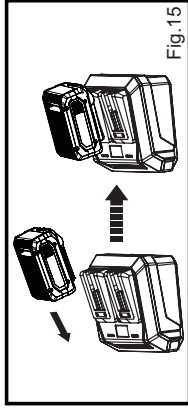

Fig. 20

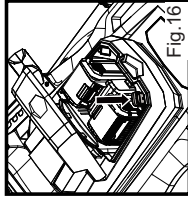

Fig. 21

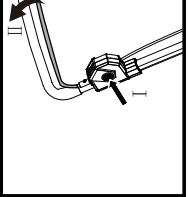

Fig. 22

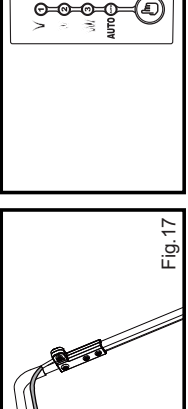

Fig. 23

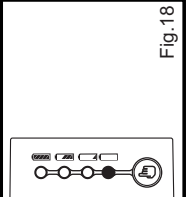

Fig. 24

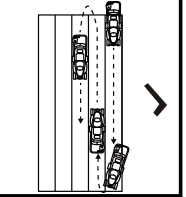

Fig. 25

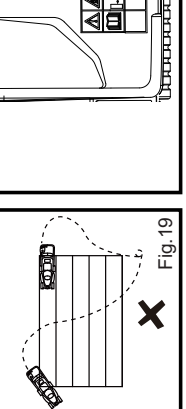

Fig. 26

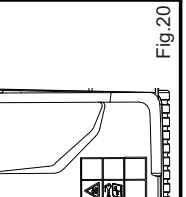

Fig. 27

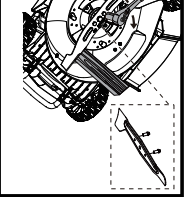

Fig. 28

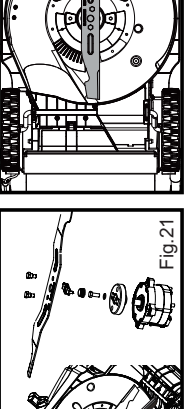

Fig. 29

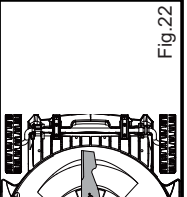

Fig. 30

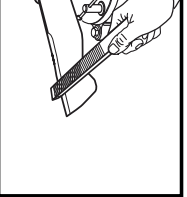

Fig. 31

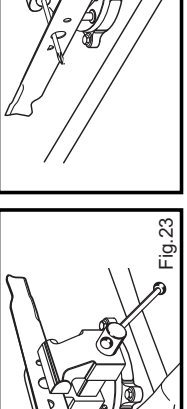

Fig. 32

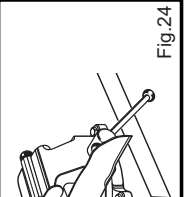

Fig. 33

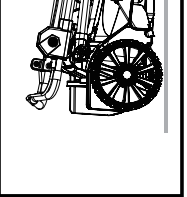

Fig. 34

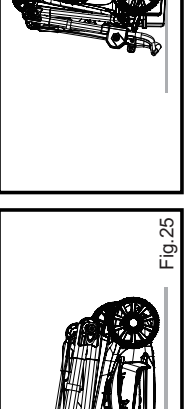

Fig. 35

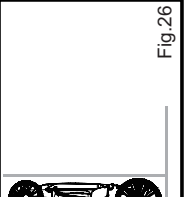

Fig. 36



CLMF4846A  
Suzhou Cleva Electric Appliance Co. Ltd  
No.8 Ting Rong Street  
Suzhou Industrial Park, Suzhou  
Jiangsu Province, China  
www.cleva-europe.com  
Made in P.R.C