



Everyday Phone with basic call blocking Quick Set-up and User Guide

Digital Cordless Phone

Important – please read first

- Only use the line cord, power supply and rechargeable batteries that come with your phone.
- Make sure the power supply is connected to a socket that you know works.
- Connect your phone to the power supply and let the batteries charge for 16 hours before connecting your phone to the phone socket.
- The base should always be plugged in to the mains power supply.

Where to put your phone

To make sure your handset gives you the best range and reception, avoid interference by placing it away from any large metal objects like fridge-freezers, microwave ovens, or electronic products such as computers and TVs.

Check the box contents

Handset



Base

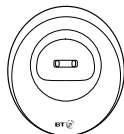

Phone line (this comes already installed)

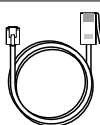

Mains power adaptor (item code 066771)

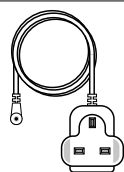

Two rechargeable batteries, AAA NiMH 500mAh (already installed in the handset)



If you bought more than one handset you'll also get:

- Extra handset
- Charger
- Mains power adaptor (item code 066771)
- Two rechargeable batteries, AAA NiMH 500mAh (already installed in the handset)



Important

Only use the mains power adaptors, cables and rechargeable batteries supplied in this box or this product might not work. Any replacement rechargeable batteries must be of the same type. BT accepts no responsibility for damage caused to your Everyday Phone if you use any other type of batteries.

Quick set-up guide

1. Plug in

1. Plug the mains power adaptor into the base, with the cable clipped in the groove provided.

2. Plug the other end of the power adaptor into the wall power socket and switch on.

3. Plug the phone line cord in to the base, but don't plug the other end into the phone wall socket.



Important

- Don't connect the phone line to a phone socket until the handset is fully charged.
- The base station should be plugged into the power socket all the time.

Where to put your phone

- Place the base within 3 metres of a mains power socket and 1.8 metres of a phone socket so the cables will reach.
- Make sure it's at least a metre away from other electrical appliances to avoid interference.
- Don't place the phone or base in a bathroom or other humid area.
- The product works by sending radio signals between the handset and base. The strength of the signal depends on where you position the base. Putting it as high as possible can help give you the best signal.

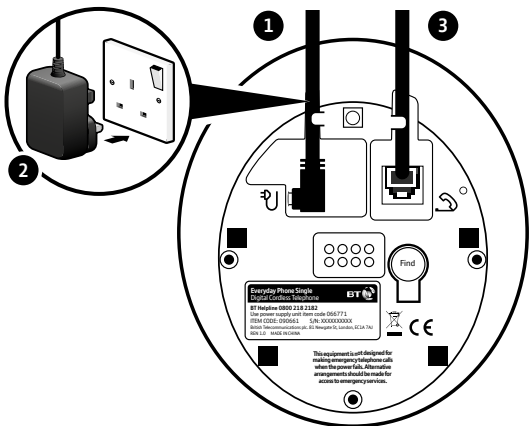

2. Charge

1. Activate the batteries by pulling the plastic tab away from the bottom of the handset.

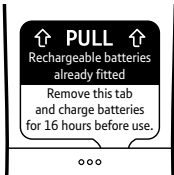

2. The handset will then check for a link with the base station. When it's found it.

3. Place the handset on the base and let it charge for **16 hours**.

4. After **16 hours**, plug the phone line cord into the phone wall socket.

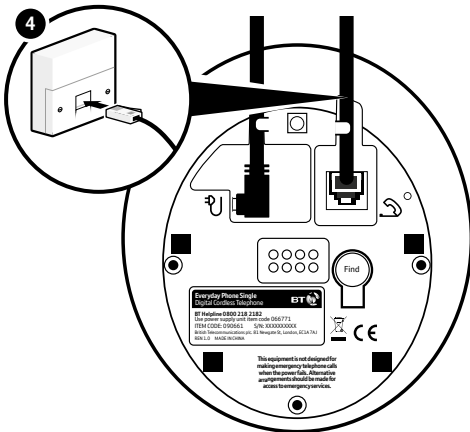

Talk/Standby time

Under ideal conditions, the handset batteries should give up to 12 hours talk time or 120 hours standby on a single charge. (This doesn't mean you can unplug the base or leave the handset for this length of time without charge).

Please note that new Ni-MH rechargeable batteries don't reach full capacity until they've been in normal use for several days.

Battery low warning

You will hear a warning beep every 2 minutes during a call and the  icon will flash.

You must recharge the handset batteries before you can use the handset. If the charge completely runs out the handset will switch off. Place the handset on the base or charger to charge.

Quick set-up guide

Set up for additional handsets (multipacks only)

1. Plug the mains power adaptor into the underside of the charger and plug the other end into the mains wall socket and switch on the power.
2. Activate the batteries as explained on page 5.
3. Place the handset on the charger to charge for 16 hours.

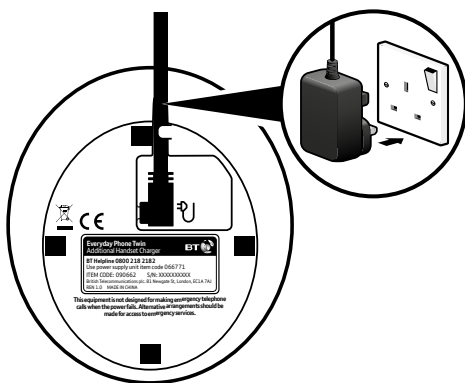

Battery performance

- To keep the batteries in the best condition, leave the handset off the base for a few hours at a time.
- Running the batteries right down at least once a week will help them last as long as possible.
- After charging your handset for the first time, subsequent charging time for the batteries is approximately 8 hours.
- The charge capacity of rechargeable batteries will go down over time, which will reduce the talk and standby time. Eventually they'll need replacing. For details on how to get replacement batteries, call the helpline on 0800 218 2182*.



Tip

If you need to take the batteries out, slide the battery cover down, then gently take the batteries out.

3. Go!

Your Everyday Phone is now ready for you to use

- For help setting the date and time, go to page 33.
- For instructions on making a call, go to page 15.
- For help personalising your phone's settings, go to page 28.

Or, you may find the answer in the Help section on page 39 or see our online frequently asked questions at bt.com/producthelp. Alternatively, call the Helpline on 0800 218 2182*.



Tip

If you call the Helpline for advice, it's a good idea to call using another phone so you can follow any instructions using your Everyday Phone.

*Calls made from within the UK mainland and mobile networks are free. International call costs may vary.

Using your Everyday Phone on a line with broadband?

To avoid problems with your broadband or noise on your phone line, you might need to plug your telephone line cord into the wall socket via a microfilter (not supplied).

If your main phone socket has a single socket, you do need to use microfilters, like this:

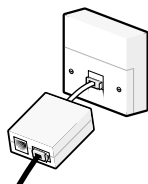

You'll need a microfilter for every phone socket where you've got equipment plugged in – up to a maximum of four per line – including alarm systems and digital TV boxes.

You can get BT ADSL micro filters from bt.com/shop

You don't need to use microfilters if your main phone socket has two separate sockets, like these:

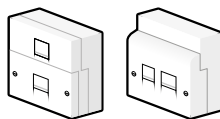

Contents

4 Quick set-up guide

10 Getting to know your phone

- Handset buttons

12 Handset display

13 Finding your way around your phone

- When the handset is switched on and at the home screen

14 Base buttons

15 Using the phone

- Make an external call
- Preparatory dialling
- End a call
- To switch the handset off
- To switch the handset on

16 Receive a call

- Call Waiting

17 Mute

- Incoming speech volume
- Redial

18 Turn the handset ringer on or off

- Find handset (Paging)

19 Phonebook

- Store entry in phonebook (up to 50)

20 Dial entry in phonebook

- Character map
- View/dial entry in phonebook

21 Edit entry in phonebook

- Delete entry in phonebook

22 Delete all entries in phonebook

- View the phonebook memory status

23 Call Blocking

- You need Caller Display
- Block incoming call number in your Calls list
- Turn call blocking on to enable blacklist

24 Add, view, edit or delete a number in your blacklist

- Block incoming call by call type

25 Caller Display and the Calls List

- Caller Display
- Calls list

26 Missed call notification

- View/dial an entry in the Calls list
- Save a Calls list entry to your phonebook

27 Delete an entry in the Calls list

- Delete the entire Calls list

28 Settings

- Handset settings
- Set the handset ringtone for external or internal calls
- Set the handset ringer volume

Contents

29 Turn the handset tones on or off

- Change the handset name

30 Change the call settings

- Base settings
- Set the base ringtone
- Set the base ringer volume

31 Set a PBX access code

- Change the system PIN

32 Reset the handset or base settings

33 Clock/Alarm

- Set the time and date
- Set an alarm
- Stopping the alarm when it goes off

34 Using additional handsets

- Register an additional handset
- De-register a handset

35 Make an internal call between handsets

- Transfer a call

36 Hold a 3-way call

37 Menu Map

39 Help

42 General information

Getting to know your phone

Handset buttons

Menu / Left option button

Press to enter the main menu, access sub-menus and confirm options.

Scroll up / Vol. up / Calls list

Enter Calls list.
Move up through menu options.
Increase volume.

Talk

In standby mode make/receive phone calls.

1

In standby, press and hold to dial BT 1571.

4

When answer machine message playing, press to replay the current message, or press twice to skip backward to the previous message.

Phonebook

Access your phonebook and add new contacts.

Do Not Disturb

In standby, press to shortcut to call block menu.

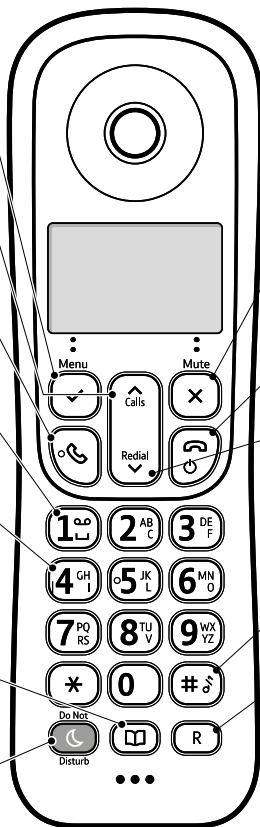

Getting to know your phone

Mute / Right option button

Press to confirm the option displayed above the button, to delete or go back to the previous screen.

Press during a call to mute your caller.

End / Standby

End a call.

Press and hold to turn handset on/off.

Scroll down / Vol. down / Redial list

In standby mode, press to see redial list.

Move down through menu options.

Decrease volume.

#







Press and hold to turn the ringer on or off.

R (Recall)

Used when connected to a switchboard/PBX and with some BT Calling Features.

Getting to know your phone

Handset display

-  Shows you how much charge is left on the handset.
-  Will appear if you're on, or starting, a call.
-  Shows when a new missed call has been received.
-  Shows when you've set an alarm clock.
-  Lets you know the handset ringer is off.
-  Lets you know the signal range from your new phone's base.
-  Shows you when Call Blocking is activated.



Handset name

Getting to know your phone

Finding your way around your phone

Your new phone's menu is easy to navigate. Each menu has a list of options, which you can see on page 37.

When the handset is switched on and at the home screen

1. Choose menu by pressing **Menu** ✓.
2. Use the **Calls** or **Redial** buttons to scroll through the available menu options.
3. When the menu you want is on the screen, press the **Menu** ✓.
4. Use **Calls** or **Redial** to scroll through the available menu options.

To go back, press **Mute** ✕.

To return to the home screen menu, press **Ⓜ**. If you don't press anything for 30 seconds, the handset will automatically return to the home screen.

Left option button

Press to select the option displayed on the screen above the button or to confirm entry.

Right option button

Press to delete or go back to the previous screen.

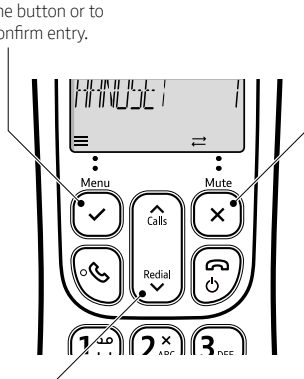

Navigation buttons

Scroll up or down through the menu options.

Base button

Find (back of base)

Press to ring all registered handsets, helpful for finding a missing handset, see page 18.

Also used during the registration process.

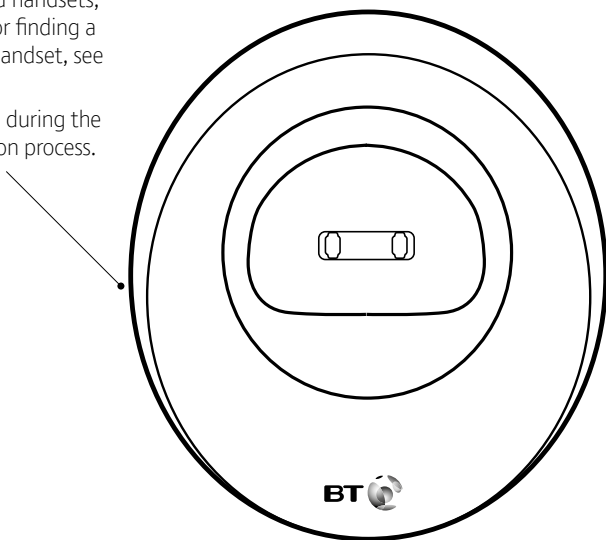



Using the phone

Make an external call

1. Press green .
2. When you hear the dial tone, enter the number.

Preparatory dialling

1. Enter the number first. If you make a mistake select **C** by pressing the Right option button  ^{Mute}  to delete the last digit.
2. Press  to dial.

End a call

1. Press red .

To switch the handset off





1. Press and hold  until the handset turns off.

To switch the handset on

1. Press and hold  until the handset turns on.

Call timer

Your handset will automatically time your outgoing and incoming calls. The handset shows the length of time both during and for a few seconds after your call.

When dialling a number,  is displayed as  and  is displayed as .

Auto end

By default you can end a call just by putting the handset back in the base.

If you switch the phone off and on again, the phone will need to be charged for some time, before the true charge status can be recalculated by the phone and accurately displayed.

Using the phone

Receive a call

When you receive a call, the phone rings and the display shows **CALL** and . If you've got a caller display service, the display shows the caller's number if it's available or the caller's name if it matches an entry stored in your contacts list.

1. Lift the handset from the base or charger to accept the call. If the handset isn't on the base or charger, you'll need to press green .

Call Waiting

If you've got a call waiting service and it is switched on, your phone will alert you to a second incoming call if you're already engaged on an external call.

1. You'll hear the call waiting tone and if you also have caller display the display will show the number of the caller, or the name if it matches an entry in your contacts.
2. Press **R** to answer the new call. Your first caller is put on hold.
3. Press **R** to toggle between the two callers.
4. Press  to hang up the current call.

Auto answer

By default, auto answer is set to On, so you can answer a call just by lifting the handset off the base.

If auto answer is set to Off, you'll need to lift the handset off the base and press  too.

Out of range warning



When the handset is out of range of the base, the display will show **OUT OF RANGE**, you will hear a warning tone. You need to move back within range of the base station.

If you move out of range when you're on a call, you'll lose your connection. The handset will automatically re-connect to the base when you move back within range.



Using the phone

5. If you hang up a current call, your phone will ring back to reconnect you to your original call if that caller is still connected.

Mute

1. During a call, press . The display shows **MUTED** and your caller can't hear you.
2. Press  to return to your caller.





Incoming speech volume

1. Press  or  to increase or decrease the volume. The first press will present the Call volume screen so you can see the current volume level. Subsequent presses will change the volume, you will hear the volume level with each press.

During a call, you can adjust the handset incoming speech volume. There are five levels. The default setting is Level 3.

Redial

Telephone numbers that you have called are saved in the Redial list. The Redial list holds up to 20 outgoing calls.

1. To redial a number, press .
2. Then press  or  to scroll to the entry you want and press  to dial the number.

Using the phone

Turn the handset ringer on or off

1. Press and hold **# 8** for 2 seconds to turn the handset ringer on or off. The home screen will display the  icon if the ringer is off.

Find handset (Paging)

You can ring a handset to help find it.

1. Press **Find** on the base. All handsets registered to the base will ring and the screen will show **PAGING**.

2. To stop the ringing, press **Find** on the base again or press  on any handset.

If you get an incoming call while you're paging a handset, the incoming call takes priority.

If the handset ringer is switched off on a handset, it will be temporarily switched back on so the handset can be found.

Paging calls can't be answered by a handset.

Phonebook

You can store up to 50 names and numbers in your list of phonebook. Names can be up to 12 characters and numbers up to 24 digits.

Store entry in phonebook (up to 50)

1. In idle mode, press . **EMPTY** is displayed if there are no numbers.
2. Press ^{Menu} to select **ADD**. Press ^{Menu} again and enter a name using the keypad and press ^{Menu} .
3. Enter a phone number and press ^{Menu} to save.
4. Press ^{Redial} to select a ring melody, then ^{Menu} to save.

To save a number to your phonebook from the incoming Calls list, press ^{Calls} , then scroll to the entry you want and press ^{Menu} . Scroll to **ADD TO PB** (phonebook) and press ^{Menu} . Enter a name using the keypad and press ^{Menu} . Then follow steps 3 to 4 above.

If you have more than one handset registered to the base, your contacts are automatically updated to all handsets (up to 5 handsets).

Entering names

Use the keypad letters to enter names, e.g. to store TOM:

- Press **8**^{TUV} once to enter T.
- Press **6**^{MNO} three times to enter O.
- Press **6**^{MNO} once to enter M.

Writing tips

To delete the last digit/character entered, select **C** by pressing the ^{Mute} button. Press **1**^{OP} to insert a space.

To enter a pause in a phonebook number

When storing a number, press and hold **#** in the place where you want the pause.

To enter a recall in a phonebook number





When storing a number, press **R** in the place where you want the recall.

Storing international numbers

Replace + with 00, then enter the rest of the number.

Phonebook





Dial entry in phonebook

1. In idle mode, press .
2. Scroll  or  to display the entry and press  to dial.



Character map

1	SPACE _ 1
2	A B C 2
3	D E F 3
4	G H I 4
5	J K L 5
6	M N O 6
7	P Q R S 7
8	T U V 8
9	W X Y Z 9
0	0
*	*?/\()

View/dial entry in phonebook













1. From the home screen, press . The first entry will be displayed.
2. Press  or  to scroll through and view the entries.
3. To dial an entry, press  when the entry is displayed.

Searching alphabetically







Press the relevant keypad button, e.g. to search for a contact beginning with S, press   four times, then scroll  through the entries.

Phonebook

Edit entry in phonebook





1. From the home screen, press .
2. Press  ^{Calls} or  ^{Redial} to scroll to the entry you want to edit and select it by pressing Left option  ^{Menu}.
3. Press  ^{Redial} to display **EDIT** and press  ^{Menu}.
4. Edit the name using  ^{Mute} to delete characters and use the keypad to enter new ones, then press  ^{Menu}.
5. Edit the number using  ^{Mute} to delete numbers and use the keypad to enter new ones, then press  ^{Menu}.
6. Press  ^{Redial} to select ring melody, then  ^{Menu} to save.

Delete entry in phonebook

1. From the home screen, press .
2. Press  ^{Calls} or  ^{Redial} to scroll to the entry you want to delete and select it by pressing  ^{Menu}.
3. Press  ^{Redial} until **DELETE** is displayed and press  ^{Menu}. You will hear a confirmation tone.





Phonebook

Delete all entries in phonebook

1. From the home screen, press . The first entry will be displayed. Select by pressing ^{Menu} .
2. Press ^{Redial}  until **DELETE ALL** is displayed and press ^{Menu} .
3. **CONFIRM?** is displayed, press ^{Menu}  to confirm delete all. The display will show **EMPTY** and you will hear a confirmation tone.

When you delete all phonebook entries they will be deleted on all the handsets you are using.

View the phonebook memory status

1. From the home screen, press . The first entry will be displayed. Select by pressing ^{Menu} .
2. Press ^{Redial}  until **PB STATUS** is displayed and press ^{Menu} .
3. The display will show the total number of contacts stored and the total amount of contacts that can be stored, e.g. **05/50 USED**.





Call Blocking

You need Caller Display

This will help you get the most out of your BT Call Blocking. You can get this from your phone service provider. Charges may apply.

Note, the same phone number can't be saved in the blacklist and phonebook.

Block incoming call number in your Calls list

1. Press , scroll to the entry and press . **DETAILS** is displayed.
2. Scroll to **ADD TO BLIST** (blacklist) and press .
3. Enter name using keypad, press . The number is displayed, press  to save. You will hear a confirmation tone.

Turn call blocking on to enable blacklist

1. Press , scroll to **CALL BLOCKER**, and press .
2. Scroll to **SETTINGS**, press .
3. Scroll to **BLOCK MODE** and press .
4. Select **BLOCK BLIST**, press .
5. Scroll to **ALWAYS ON**, press . **CALLBLOCK ON** is displayed.

Call Blocking

Add, view, edit or delete a number in your blacklist

1. Press ^{Menu} ✓, scroll ^{Redial} ↓ to **CALL BLOCKER**, and press ^{Menu} ✓.
2. Scroll ^{Redial} ↓ to **BLACK LIST**, press ^{Menu} ✓.
3. Scroll ^{calls} ↑ or ^{Redial} ↓ to number you want to view, edit or delete in your blacklist. Or go to step 4 to add a number to your blacklist.
4. Whilst in **BLACK LIST** menu, press ^{Menu} ✓. **EMPTY** is shown, press ^{Menu} ✓ again then scroll ^{calls} ↑ or ^{Redial} ↓ to **ADD, VIEW, EDIT, DELETE** or **DELETE ALL** and press ^{Menu} ✓.
5. Follow the on-screen instructions.

Block incoming call by call type

1. Press ^{Menu} ✓, scroll ^{Redial} ↓ to **CALL BLOCKER**, and press ^{Menu} ✓.
2. Scroll to **SETTINGS**, press ^{Menu} ✓.
3. Scroll to **CALL TYPE**, press ^{Menu} ✓.
4. Scroll to the call type you want to block – **WITHHELD, INTERNAT'L, UNAVAILABLE** or **PAYPHONE** – and press ^{Menu} ✓. You'll hear a confirmation tone.

Caller Display and the Calls List

Caller Display

If you've subscribed to a Caller Display service, you'll be able to see your caller's number on your handset display (provided it's not withheld) before you answer a call.

If your caller's name is stored in your contacts list and it matches the number calling, you'll see the caller's name on the display instead. If you haven't subscribed to a Caller Display service **Incoming call** will be displayed when you receive a call.

Calls list

The Calls list holds up to 20 incoming (missed and answered) calls. The date and time of the call is also stored. If you haven't subscribed to a Caller Display service, no number will be displayed for incoming calls.

Calls are listed in chronological order with the most recently received/made call at the top of the list.

When the list is full and a new call is received/made, the oldest entry will be deleted automatically.

The Calls list can hold numbers up to 24 digits and names up to 12 characters.

You'll need to subscribe to your network provider's Caller Display service for this feature to work. You might have to pay a fee. For more information on BT Calling Features, go to bt.com/callingfeatures

For the caller's name to be displayed, make sure you've stored the full telephone number in your contacts list, including the dialling code. There are some incoming calls where a number is not displayed and a network message is recorded instead:

Unavailable = number is unavailable

Withheld = number has been withheld

International = International number

Operator = call from the operator

Payphone = call from a payphone

Ringback = a ringback call

Caller Display and the Calls List

Missed call notification

The number of missed calls will be shown e.g. 10 new calls. You can clear the notification by viewing the calls list on any handset registered to the base.

View/dial an entry in the Calls list

1. Press \hat{C} . The most recent entry is at the top of the list. (If there are no entries **EMPTY** will be displayed.)
2. Press \hat{C} or \checkmark to scroll through and view the list.
3. To dial an entry, when the entry you want is displayed, press \checkmark .

Save a Calls list entry to your phonebook

1. Press \hat{C} , then press \hat{C} or \checkmark to scroll to the entry you want and select by pressing \checkmark .
2. Scroll to **ADD TO PB**, press \checkmark .
3. Enter name using keypad and press \checkmark .
4. Enter phone number and press \checkmark to save.
5. Press \checkmark to select ring melody, then \checkmark to save.
6. If you have more than one handset registered to the base, they will be updated automatically.

Calls list indicator

Ⓢ = missed call
When the Calls list is open, press \hat{C} to scroll from the newest call to the oldest, or press \checkmark to scroll from the oldest call to the newest. If you need to edit the number or name, press \hat{C} or \checkmark to move cursor left or right and **C** to delete unwanted digits/characters then use the keypad to enter new ones.

The other handset(s) must be in idle mode to work.

Caller Display and the Calls List

Delete an entry in the Calls list

1. Press \hat{c} , then press \hat{c} or \checkmark to scroll to the entry you want to delete and select by pressing \checkmark .
2. Press \checkmark until **DELETE** is displayed and press \checkmark . You will hear a confirmation tone.

Delete the entire Calls list

1. Press \hat{c} , then display any entry and select by pressing the \checkmark button.
2. Press \checkmark until **CONFIRM?** is displayed, then press \checkmark . You will hear a confirmation tone.

Settings

Handset settings



Set the handset ringtone for external or internal calls

1. Press ^{Menu} ✓, scroll ^{Redial} ↓ to **HS SETTINGS** and press ^{Menu} ✓.
2. **ALARM** is displayed, scroll to **RING SETUP**, press ^{Menu} ✓.
3. **INT. RING** is displayed, press ^{Menu} ✓.
Or, press ^{Redial} ↓ to display **EXT. RING** and then press ^{Menu} ✓. The current ringtone will be played.
4. Press ^{Calls} ^ or ^{Redial} ↓ to hear the different ringtones and press ^{Menu} ✓ to save your choice, you will hear a confirmation tone.

Set the handset ringer volume

1. Press ^{Menu} ✓, scroll ^{Redial} ↓ to **HS SETTINGS** and press ^{Menu} ✓.
2. Scroll to **RING SETUP**, press ^{Menu} ✓.
3. Press ^{Redial} ↓ until **RING VOLUME** is displayed and press ^{Menu} ✓.
4. The current external ringtone will play at the current volume. Use the ^{Calls} ^ or ^{Redial} ↓ button to increase or decrease the volume, or turn the ringer off. You will see the volume level change on the display or **VOLUME OFF** will be displayed if you turn the ringer off.
5. Press ^{Menu} ✓ to save your choice, you will hear a confirmation tone.

Choose from 5 handset ringtones. The default external ringtone is Melody 1 and the internal ringtone is Melody 2.

There are 5 handset ringer volume levels plus Ringer Off. The default setting is Level 3. If you turn the ringer off, the  icon will be displayed on the home screen. As a quick way to turn the handset ringer off, press and hold **#** .

Settings

Turn the handset tones on or off

1. Press ^{Menu} ✓, scroll ^{Redial} ↓ to **HS SETTINGS** and press ^{Menu} ✓.
2. **ALARM** is displayed. Press ^{Redial} ↓ until **tone SETUP** is displayed and press ^{Menu} ✓.
3. **KEY TONE** is displayed, press ^{Menu} ✓ or press ^{Redial} ↓ to display **BATTERY TONE** or **OUT OF RANGE TONE** and then press ^{Menu} ✓.
4. Press ^{calls} ^ or ^{Redial} ↓ to select **ON** or **OFF** then press ^{Menu} ✓ to save, you will hear a confirmation tone.

There are three handset tones: keypad tones, battery tones and out of range tones. You can turn these on or off, the default setting is On.

With keypad tones turned on, you will hear a beep after each button press.

To alert you that the battery needs charging, you will hear a low battery tone while you are on a call.

You will also hear a warning tone if the phone goes out of range.

Change the handset name

1. Press ^{Menu} ✓, scroll ^{Redial} ↓ to **HS SETTINGS** and press ^{Menu} ✓.
2. **ALARM** is displayed, press ^{Redial} ↓ until **RENAME HS** is displayed and press ^{Menu} ✓.
3. Edit the name by selecting **C** to delete the characters, then enter the new name and press ^{Menu} ✓ to save. You will hear a confirmation tone.

A handset name can be a maximum of 10 characters.

Settings

Change the call settings

1. Press ^{Menu}✓, scroll ^{Redial}↓ to **HS SETTINGS** and press ^{Menu}✓.
2. **ALARM** is displayed, press ^{Redial}↓ until **AUTO ANSWER** is displayed and press ^{Menu}✓.
3. Press ^{Calls}↑ or ^{Redial}↓ to select **On** or **Off** then press ^{Menu}✓ to save, you will hear a confirmation tone.

Base settings

Set the base ringtone

1. Press ^{Menu}✓, scroll ^{Redial}↓ to **BS SETTINGS** and press ^{Menu}✓.
2. **BS RINGER** is displayed, press ^{Menu}✓.
3. The current ringtone will be played at the base. Press ^{Calls}↑ or ^{Redial}↓ to hear the different ringtones and press ^{Menu}✓ to save your choice. You will hear a confirmation tone.

Set the base ringer volume

1. Press ^{Menu}✓, scroll ^{Redial}↓ to **BS SETTINGS** and press ^{Menu}✓.
2. **BS RINGER** is displayed, press ^{Redial}↓ until **RING VOLUME** is displayed and press ^{Menu}✓.
3. The current base ringtone will play at the current volume. Use the ^{Calls}↑ or ^{Redial}↓ button to increase or decrease the volume, or turn the

The default setting for all call settings is On.

If Auto answer is set to On you can answer a call by lifting the handset off the base. If it's set to Off, you'll need to lift the handset off the base and then press .

Choose from 5 base ringtones. The default base ringtone is Melody 1.

There are 5 base ringer volume levels plus Ringer Off. The default setting is Level 3

Settings

ringer off. You will see the volume level change on the display.

4. Press ^{Menu} ✓ to save your choice. You will hear a confirmation tone.

Set a PBX access code

1. Press ^{Menu} ✓, scroll ^{Redial} ▼ to **BS SETTINGS** and press ^{Menu} ✓.
2. **BS RINGER** is displayed, press ^{Redial} ▼ until **PBX ACCESS** is displayed and press ^{Menu} ✓.
3. Enter the number you want (maximum of 1 digit) and press ^{Menu} ✓ to save. You will hear a confirmation tone.

Change the system PIN

1. Press ^{Menu} ✓, scroll ^{Redial} ▼ to **BS SETTINGS** and press ^{Menu} ✓.
2. **BS RINGER** is displayed, press ^{Redial} ▼ until **CHANGE PIN** is displayed and press ^{Menu} ✓.
3. You will be prompted to enter the current 4 digit PIN, then press ^{Menu} ✓.
4. Enter the new 4 digit PIN again and press ^{Menu} ✓.
5. Enter the new 4 digit PIN again to confirm and press ^{Menu} ✓. You will hear a confirmation tone.

If you're connected to a switchboard, you might need to enter an access code (e.g.9) before each number is dialled. Your Everyday Phone can store an access code which is automatically dialled before each number.

If you wish to revert to not using a PBX access code, you need to go into the PBX code menu and delete all the digit by selecting **C**, then press ^{Menu} ✓ to save.

The default system PIN is **0000**. You can change this to your own preferred 4-digit code. The system PIN is used when changing certain settings and for registration/de-registration. If you make a mistake, select **C** to delete a digit.

Settings

Reset the handset or base settings

1. Press ^{Menu} ✓, scroll ^{Redial} ✓ to **DEFAULT** and press ^{Menu} ✓.
2. **PIN?----** is displayed, enter the 4 digit PIN and press ^{Menu} ✓.
3. **CONFIRM?** is displayed, press ^{Menu} ✓.
You will hear a confirmation tone.

If you reset the phone settings all the phone settings will return to their default settings, e.g. the handset name, ringer melody, all volume levels, display and alarm settings.

Clock/Alarm

If you didn't set the time and date when you first set-up your phone then you will need to do so before you can set an alarm.



Important

You must enter the full date: day, month and year. The time is set in 24 hour format.

Set the time and date

1. Press ^{Menu} ✓, scroll ^{Redial} ✓ to **HS SETTINGS** and press ^{Menu} ✓.
2. Scroll ^{Redial} ✓ until **DATE & TIME** is displayed and press ^{Menu} ✓. **SET TIME** is displayed, press ^{Menu} ✓.
3. Enter the time using the keypad and press ^{Menu} ✓.
4. Enter the day, month and year and press ^{Menu} ✓. You'll hear a confirmation tone.

Set an alarm

1. Press ^{Menu} ✓, scroll ^{Redial} ✓ to **HS SETTINGS** and press ^{Menu} ✓.
2. **ALARM** is displayed, press ^{Menu} ✓.
3. Press ^{Calls} ^ or ^{Redial} ✓ to turn the alarm **ON** (or **OFF**) and press ^{Menu} ✓.

4. Enter the alarm time using the keypad. Press ^{Menu} ✓. **SNOOZE** is displayed, press ^{Menu} ✓.

5. Press ^{Calls} ^ or ^{Redial} ✓ to turn the snooze **ON** or **OFF**, press ^{Menu} ✓ to confirm your choice. You will hear a confirmation tone.

Stopping the alarm when it goes off

When the alarm goes off, the selected ring tone will play and **ALARM ON** will flash.

To stop the alarm, press any key.

If snooze function is activated, the alarm will sound again after seven minutes until you go into alarm settings and turn it off.

When you've set an alarm, the  icon will appear on the idle screen to confirm an alarm has been set. If an incoming call is received while the alarm is going off, the alarm notification will immediately stop and the incoming call will be shown on the display. The alarm will not resume.

Using additional handsets

If you've bought a Everyday Phone multiple pack, any additional handsets come pre-registered to the base. However, if you purchase an additional handset separately, you must register it to your Everyday Phone base before it can be used.

Register an additional handset

1. Press and hold the **Find** button on the base for 5 seconds. The base is entered into registration mode. You will hear a confirmation tone.
2. Press ^{Menu} ✓, scroll ^{Redial} ↓ to **REGISTRATION** and press ^{Menu} ✓.
3. Enter the 4 digit PIN and press ^{Menu} ✓. The default system PIN is 0000.
4. Once registration is successful the handset will show **HANDSET X** (with X being the next assigned handset number).

De-register a handset

1. Press ^{Menu} ✓, scroll ^{Redial} ↓ to **BS SETTINGS** and press ^{Menu} ✓.
2. Press ^{Redial} ↓ until **DELETE HS** is displayed and press ^{Menu} ✓.
3. Enter 4 digit system PIN and press ^{Menu} ✓.

You can register up to five GAP compliant handsets to your Everyday Phone base to extend your phone system without needing to install telephone extension sockets for each new phone.

If a handset becomes un-registered it will need to be registered to the base again.

If registration isn't successful the first time, please try again in case the base registration period ran out of time.



If there are already five handsets registered to the base, the registration will fail. You must de-register another handset before you can register the new one.

Registering another make of handset to your Everyday Phone base

If you want to register another make of handset (i.e. not a Everyday Phone handset) to your Everyday Phone base you will need to follow the Registration instructions that came with the handset first and then continue with the base part of the registration procedure.





Please note that registering other types of handset will only provide limited compatibility i.e. you may only be able to make and receive calls on the additional handset.

Using additional handsets

4. Press  or  to display the handset you wish to de-register and press . You will hear a confirmation tone.







Make an internal call between handsets

If you have more than one handset registered to the base, you can make internal calls between two handsets.

1. Press  and scroll  or  to registered handset you want to call.'
2. Press  to call the selected handset.
3. Press  to end the call.

Transfer a call

You can transfer an external call to another handset registered to the base.

1. During a call, press the  button, **INTERCOM** is displayed.
2. Press  and scroll  or  to handset you want to transfer the call to, press  to establish internal call.
3. Press  to complete call transfer.

You can also choose **All handsets** if you want to call all handsets registered to the base. If a handset answers, the handset name will be displayed on your screen. If an external call is received while an internal call is being made, the handsets registered to the base will display the external call information and you will hear the call waiting tone in the handset earpiece.

Using additional handsets

Hold a 3-way call

You can hold a 3-way call between 2 handsets, if you have more than 1 registered to your base and 1 external caller.

1. During a call, press the ^{Menu} ✓ button, **INTERCOM** is displayed.
2. Press ^{Menu} ✓ and scroll ^{Call} ⬆ or ^{Redial} ⬇ to handset you want to transfer the call to, press ^{Menu} ✓ to establish internal call.
3. Press and hold * on the call handset to establish a conference call, **CONFERENCE** is displayed.
4. Both parties on conference call will need to press ⓞ to end the external call. Text box medium text

You can also choose **All handsets** if you want to call all handsets registered to the base. If a handset answers, the handset name will be displayed on your screen. If the internal call is not answered after 60 seconds you will see **Handset not available** on your display and you will be returned to your external caller.

Menu Map

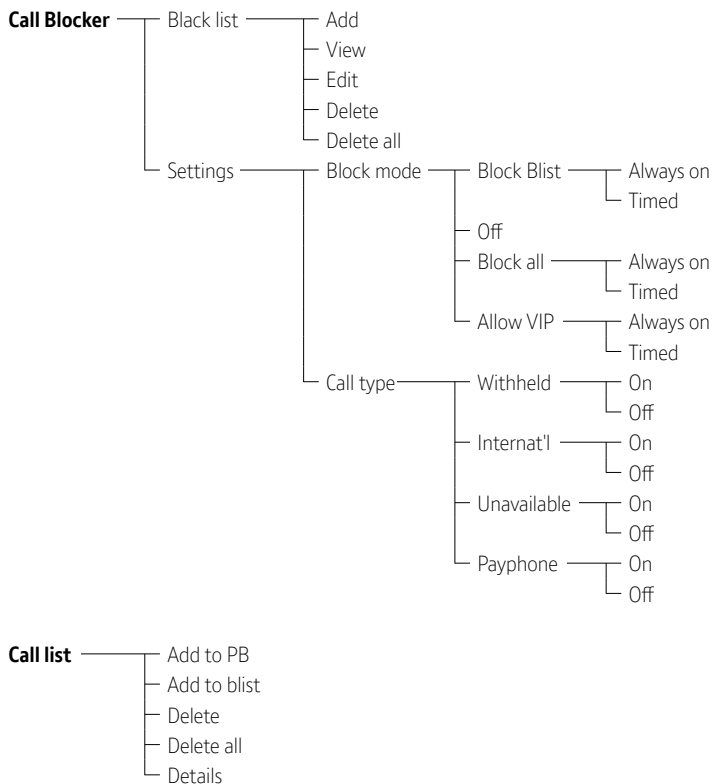

Menu Map

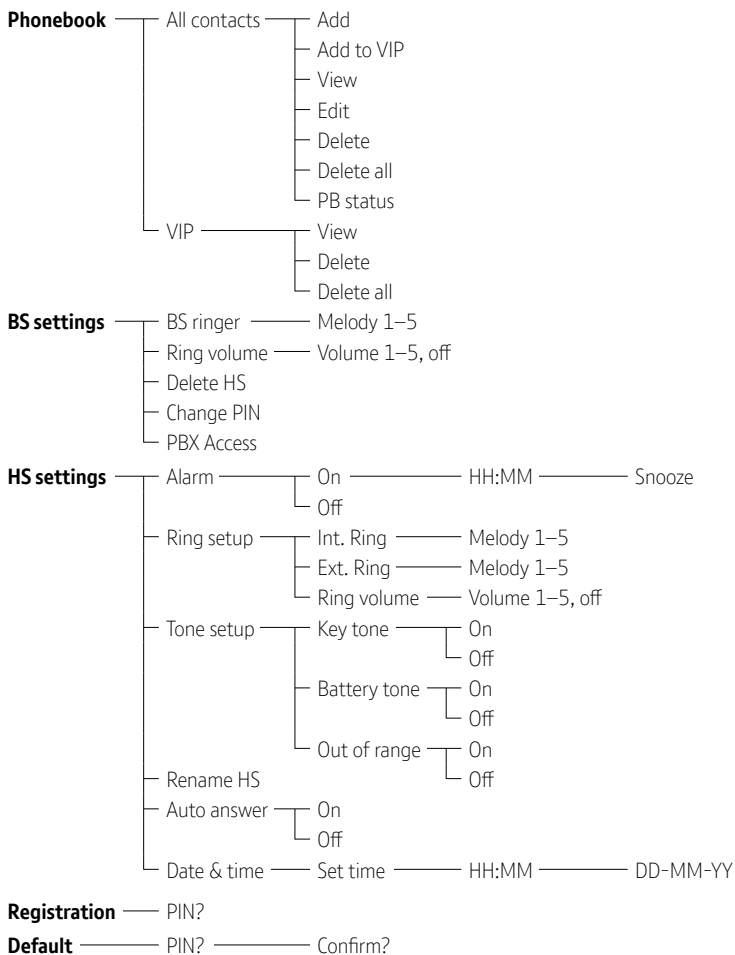

Help

Phone doesn't work

- Have you activated the batteries correctly? See page 5.
- Check that the mains power is correctly connected.

No dial tone or line cord error message displayed on screen

- Is the telephone cord plugged into the base and phone wall socket?
- Check that the mains power is correctly connected.
- Only use the telephone cord supplied with the phone.

Can't make or receive calls

- Check that the mains power is correctly connected.
- The batteries may need recharging.
- Has there been a power cut? If so, place the handset back on the base for ten seconds and try again. If it still doesn't work, disconnect the batteries and mains power for ten minutes, then reconnect and try again.

Handset doesn't ring

- The ringer volume may be switched off, see page 28.
- Check that the mains power is correctly connected.
- Make sure the handset is registered to the base, see page 34.

No display

- The batteries may be flat, dead or incorrectly inserted.
- Recharge or replace the batteries.

Range icon flashes

- Make sure the handset is registered to the base, see page 34.
- Check that the mains power is correctly connected to the base.
- Check that the handset is within range of the base.
- If the batteries are low, place the handset on the base/charger to recharge.

You hear the busy tone when you press

- Make sure the handset is in range of the base.
- Another handset registered to your Everyday Phone base may be on the line.

No Caller Display number/ name displayed

- Have you subscribed to a Caller Display service from your network provider? See page 25.
- The caller may have withheld their number.
- Network may not have the callers number information.
- An exact name/number match was not found in your contacts. Check that you've stored the full STD dialling code.

Can't register a handset to a base

- You can register up to five handsets to your Everyday Phone base and you can register your Everyday Phone handset to up to four bases. Check that you've not exceeded the limits.
- Check that you've entered the correct system PIN number (default PIN 0000).
- Check that you're at least one metre away from other electrical equipment to avoid interference when registering.

Base unit does not ring, but the lights are on

- Have you connected the telephone line correctly?
- Is the base ringer set to off?
- You may have a faulty line or socket. Try using another socket or line.

If you are a BT customer then please call 0800 800 151 or your network provider if you still have problems.

Buzzing noise on my phone or on other electrical equipment nearby

- Sometimes other electrical equipment can interfere with your Everyday Phone if it's placed too close. We recommend that you place your Everyday Phone at least one metre away from electrical appliances or metal obstructions to avoid any risk of interference.

Help

Customer Helpline

If you're still having problems, call us on **0800 218 2182*** or go to bt.com/producthelp

General sales enquiries

- BT Residential lines – call **150**.
BT Business lines – call **152**.
- For non BT line customers, call **0800 800 150** (residential) or **0800 800 152** (business).
- Additional handsets are available to purchase from the Helpdesk on **0800 218 2182***.

Billing enquiries

Please see the phone number shown on your BT bill.

General information



Important

This equipment is not designed for making emergency phone calls when the power fails. Alternative arrangements should be made for access to emergency services. This product is intended for connection to analogue public switched phone networks and private switchboards in the United Kingdom.

Replacing the handset batteries

After a time, you might find that the handset batteries run out of charge more quickly. This is a standard sign of wear and the batteries will need replacing.

1. Open the battery compartment cover.
2. Lift the battery out and remove the batteries. Replace with two new AAA Ni-MH 500mAh rechargeable batteries.
3. Replace the battery compartment cover.

Caution

Don't immerse batteries in water, throw them into a fire or dispose of them with ordinary domestic refuse. BT accepts no responsibility for damage caused to your Everyday Phone by using any other types of batteries.

There is a risk of explosion if incorrect batteries are fitted.

Safety

- Only use the power supply suitable for the Everyday Phone. Using an unauthorised power supply will invalidate your guarantee and may damage the phone. The item code for the base mains power supply is 066771. If you've bought a multiple pack, the item code for the charger mains power supply is 066771.
- Use only the approved rechargeable batteries supplied. Spare rechargeable batteries are available from the Everyday Phone Helpline on **0800 218 2182***.
- Don't open the handset (except to replace the handset batteries) or the base. This could expose you to high voltages or other risks. Contact the Helpline on **0800 218 2182*** for all repairs.

General information

- Radio signal transmitted between the handset and base may cause interference to hearing aids.
- It is recommended that advice from a qualified expert be sought before using this product in the vicinity of emergency/intensive care medical equipment.
- It is recommended that if you have a pacemaker fitted you check with a medical expert before using this product.
- Your product may interfere with other electrical equipment, e.g. TV and radio sets, clock/alarms and computers if placed too close.
- It is recommended that you place your product at least one metre away from such appliances to minimise any risk of interference.
- Never dispose of batteries in a fire. There is a serious risk of explosion and/or the release of highly toxic chemicals.

Cleaning

Clean the handset and base (or charger) with a damp (not wet) cloth, or an anti-static wipe. Never use household polish as this will damage the product. Never use a dry cloth as this may cause a static shock.

Environmental

- Do not expose to direct sunlight.
- The handset may become warm when the batteries are being charged or during prolonged periods of use. This is normal. However, we recommend that to avoid damage you do not place the product on any surface susceptible to heat damage.
- Do not stand your product on carpets or other surfaces which generate fibres, or place it in locations preventing the free flow of air over its surfaces.
- Do not submerge any part of your product in water and do not use it in damp or humid conditions, such as bathrooms.
- Do not expose your product to fire, explosive or other hazardous conditions.
- There is a slight chance your phone could be damaged by an electrical storm. We recommend that you unplug the power and phone line cord during an electrical storm.

General information

How to recycle your equipment

The symbol shown here and on the product means that the product is classed as electrical or electronic equipment, so DO NOT put it in your normal rubbish bin.



It's all part of the Waste Electrical and Electronic Equipment (WEEE) Directive to recycle products in the best way – to be kinder to the planet, get rid of dangerous things more safely and bury less rubbish in the ground.

You should contact your retailer or supplier for advice on how to dispose of this product in an environmentally friendly way.

Warning

You won't be able to call 999 from this phone if there's a power cut, so make sure you've got another way to call for help in an emergency.

Radio Equipment Directive Declaration of Conformity

Hereby, British Telecommunications plc declares that the radio equipment type Everyday Phone Telephone (090661, 090662, 090663) is in compliance with Directive 2014/53/EU.

The full text of the EU declaration of conformity is available at the following internet address: bt.com/producthelp

EU Frequency band restriction

This device may be used in each member state.

Radio transmission information

Frequency range

1881.792 – 1897.344MHz

Max power

250mW

Operating temperature

0°C to 40°C.

Guarantee

Your Everyday Phone is guaranteed for 12 months from the date of purchase. Subject to the terms listed below, the guarantee will provide for the repair of, or at BT's or its agent's discretion, the option to replace the Everyday Phone or any component thereof, (other than batteries), which is identified as faulty or below standard, or as a result of inferior workmanship or materials. Products over 28 days old from the date of purchase may be replaced with a refurbished or repaired product.

General information

Guarantee conditions

- The guarantee shall only apply to defects that occur within the 12 month guarantee period.
- Proof of purchase is provided.
- The equipment is returned to BT or its agent as instructed.
- This guarantee doesn't cover any faults or defects caused by accidents, misuse, fair wear and tear, neglect, tampering with the equipment, or any attempt at adjustment or repair other than through approved agents.
- This guarantee does not affect your statutory rights.

Within the 12 month guarantee period

Prior to returning your product, please read the Help section beginning on page 39 or contact the Everyday Phone Helpline on 0800 218 2182*. Additional answers to frequently asked questions are available from bt.com/producthelp

In the unlikely event of a defect occurring, the helpdesk will issue a Fault Reference Authorisation (FRA) number and instructions for replacement or repair. Please note

you will need the FRA number before returning the product. This does not affect your statutory rights.

Outside of the 12 month guarantee period

If your product needs repair after the guarantee period has ended, the repair must meet the approval requirements for connection to the phone network.

We recommend that you contact BT's recommended repair agent Discount Communications on 0800 980 8999 or a local qualified repairer.

Returning your phone

If the Helpline is unable to remedy your problem they will issue a Fault Reference Authorisation number and ask you to return the product to your original place of purchase. Where possible, pack the product in its original packaging. Please remember to include all parts, including the line cords, power supply units and the original batteries.

General information

Technical details

How many phones can I have?

All items of telephone equipment have a Ringer Equivalence Number (REN), which is used to calculate the number of items which may be connected to any one telephone line. Your Everyday Phone has a REN of 1. A total REN of 4 is allowed. If the total REN of 4 is exceeded, the telephones may not ring. With different telephone types there is no guarantee of ringing, even when the REN is less than 4.

Any additional handsets and chargers that you register have a REN of 0.

Connecting to a switchboard

Switchboard compatibility

This telephone may be connected to most types of switchboard, however in the event of any difficulties, consult your switchboard Service Provider.

Recall (R)

Recall is used when connected to certain switchboards/PBXs and some BT Calling Features, or those services available via your network provider. The Everyday Phone supports timed break recall but not earth loop recall.



Offices worldwide

The services we've described in this publication may not always be available and we may change them. Nothing we've written here is contractual. When we supply services and equipment, our terms and conditions apply.

© British Telecommunications plc 2017
We're registered in England at 81 Newgate Street,
London EC1A 7AJ (company number 1800000).

Available in other formats including braille, large print or audio CD. If you would like a copy, please call 0800 218 2182*.

* Calls made from within the UK mainland and mobile networks are free. International call costs may vary.

Everyday Phone (12/17) Issue 3

