



Side by Side Refrigerator Freezer

INSTRUCTION MANUAL

English.....	3
Italiano.....	19
Français.....	35
Deutsch.....	51
Español.....	67
Português.....	83
Русский.....	99
Nederlands.....	113
Αγγλικά.....	130
Čeština.....	149
Slovenčina.....	165

Content	
SAFETY INFORMATION	3
Care and cleaning	9
SCRAPPING OLD APPLIANCES	10
Conformity	10
Energy Saving	10
Overview	11
Remove the doors	12
Space Requirement	13
Levelling the refrigerator	13
Positioning.....	13
Electrical connection	14
Daily use	14
Using the Control Panel	14
Using the Water Dispenser” (If present).	14
Door Open Alarm	15
Child safety lock	15
First use	16
Freezing fresh food.....	16
Thawing.....	16
Ice-cube.....	16
Accessories	16
Helpful hints and tips	16
Cleaning	17
Troubleshooting	17

Thank you for purchasing this product. Before using your refrigerator, please carefully read this instruction manual in order to maximize its performance. Store all documentation for subsequent use or for other owners. This product is intended solely for household use or similar applications such as:

1. the kitchen area for personnel in shops, offices and other working environments
2. on farms, by clientele of hotels, motels and other environments of a residential type
3. at bed and breakfasts (B & B)
4. for catering services and similar applications not for retail sale.

This appliance must be used only for purposes of storage of food, any other use is considered dangerous and the manufacturer will not be responsible for any omissions. Also, it is recommended that you take note of the warranty conditions.

SAFETY INFORMATION

This guide contains many important safety information. Please, we suggest you keep these instructions in a safe place for easy reference and a good experience with the appliance. The refrigerator contains a refrigerant gas (R600a: isobutane) and insulating gas (cyclopentane), with high compatibility with the environment, that are, however, inflammable.



Caution: risk of fire
If the refrigerant circuit should be damaged:

- **Avoid opening flames and**

sources of ignition.

Thoroughly ventilate the room in which the appliance is situated

WARNING!

- Care must be taken while cleaning/carrying the appliance to avoid touching the condenser metal wires at the back of the appliance, as you might injure your fingers and hands or damage your product.
- This appliance is not designed for stacking with any other appliance. Do not attempt to sit or stand on top of your appliance as it is not designed for such use. You could injure yourself or damage the appliance.
- Make sure that mains cable is not caught under the appliance during and after carrying/moving the appliance, to avoid the mains cable becoming cut or damaged.
- When positioning your appliance take care not to damage your flooring, pipes, wall coverings etc.
- Do not move the appliance by pulling by the lid or handle. Do not allow children to play with the appliance or tamper with the controls. Our company declines to accept any liability should the instructions not be followed.
- Do not install the appliance in humid, oily or dusty places, nor expose it to direct sunlight and to water.
- Do not install the appliance near heaters or inflammable materials.
- If there is a power failure do not open the lid. Frozen food should not be affected if the failure lasts for less than 20 hours. If the failure is longer, then the food should be checked and eaten immediately or cooked and then refrozen.
- If you find that the lid of the chest freezer is difficult to open just after you have closed it, don't worry. This is due to the pressure difference which will equalize and allow the lid to be opened normally after a

- few minutes.
- Do not connect the appliance to the electricity supply until all packing and transit protectors have been removed.
 - Leave to stand for at least 4 hours before switching on to allow compressor oil to settle if transported horizontally.
 - This freezer must only be used for its intended purpose (i.e. storing and freezing of edible foodstuff).
 - Do not store medicine or research materials in the Wine Coolers. When the material that requires a strict control of storage temperatures is to be stored, it is possible that it will deteriorate or an uncontrolled reaction may occur that can cause risks.
 - Before performing any operation, unplug the power cord from the power socket.
 - On delivery, check to make sure that the product is not damaged and that all the parts and accessories are in perfect condition.
 - If in the refrigeration system a leak is noted, do not touch the wall outlet and do not use open flames. Open the window and let air into the room. Then call a service center to ask for repair.
 - Do not use extension cords or adapters.
 - Do not excessively pull or fold the power cord or touch the plug with wet hands.
 - Do not damage the plug and/or the power cord; this could cause electrical shocks or fires.
 - If the supply cord is damaged, it must be replaced by the manufacturer, its service agent or similarly qualified person in order to avoid a hazard.
 - Do not place or store inflammable and highly volatile materials such as ether, petrol, LPG, propane gas, aerosol spray cans, adhesives, pure alcohol, etc. These materials may cause an explosion.
 - Do not use or store inflammable sprays, such as

- spray paint, near the Wine Coolers. It could cause an explosion or fire.
- Do not place objects and/or containers filled with water on the top of the appliance.
 - We do not recommend the use of extension leads and multi-way adapters.
 - Do not dispose of the appliance on a fire. Take care not to damage, the cooling circuit/pipes of the appliance in transportation and in use. In case of damage do not expose the appliance to fire, potential ignition source and immediately ventilate the room where the appliance is situated.
 - The refrigeration system positioned behind and inside the Wine Coolers contains refrigerant. Therefore, avoid damaging the tubes.
 - Do not use electrical appliances inside the food storage compartments of the appliance, unless they are of the type recommended by the manufacturer.
 - Do not damage the refrigerant circuit.
 - Do not use mechanical devices or other means to accelerate the defrosting process, other than those recommended by the manufacturer.
 - Do not use electrical appliances inside the food storage compartments, unless they are of the type recommended by the manufacturer.
 - Do not touch internal cooling elements, especially with wet hands, to avoid cracks or injuries.
 - Maintain the ventilation openings in the appliance enclosure or in the built-in structure, free of obstruction.
 - Do not use pointed or sharp-edged objects such as knives or forks to remove the frost.
 - Never use hairdryers, electrical heaters or other such electrical appliances for defrosting.
 - Do not scrape with a knife or sharp object to remove frost or ice that occurs. With

these, the refrigerant circuit can be damaged, the spill from which can cause a fire or damage your eyes.

- Do not use mechanical devices or other equipment to hasten the defrosting process.
- Absolutely avoid the use of open flame or electrical equipment, such as heaters, steam cleaners, candles, oil lamps and the like in order to speed up the defrosting phase.
- Never use water wash the compressor position, wipe it with a dry cloth thoroughly after cleaning to prevent rust.
- It is recommended to keep the plug clean, any excessive dust residues on the plug can be the cause of fire.
- The product is designed and built for domestic household use only.
- The guarantee will be void if the product is installed or used in commercial or non-residential domestic household premises.
- The product must be

correctly installed, located and operated in accordance with the instructions contained in the User Instructions Booklet provided.

- The guarantee is applicable only to new products and is not transferable if the product is resold.
- Our company disclaims any liability for incidental or consequential damages.
- The guarantee does not in any way diminish your statutory or legal rights.
- Do not perform repairs on this Wine Cooler. All interventions must be performed solely by qualified personnel.
- If you are discarding an old product with a lock or latch fitted to the door, ensure that it is left in a safe condition to prevent the entrapment of children.
- This appliance can be used by children aged from 8 years and above and by persons with reduced physical, sensory or mental capabilities or with a lack of

experience and knowledge; provided that they have been given adequate supervision or instruction concerning how to use the appliance in a safe way and understand the hazards involved.

- Children should not play with the appliance. Cleaning and user maintenance should not be made by children without supervision.
- Locks: If your Fridge/Freezer is fitted with a lock, to prevent children being entrapped keep the key out of reach and not in the vicinity of the appliance. If disposing of an old Fridge/Freezer break off any old locks or latches as a safeguard.
- Children aged from 3 to 8 years are allowed to load and unload this appliance.

WARNING! When positioning the appliance, ensure the supply cord is not trapped or damaged.

WARNING! Do not locate multiple portable socket-outlets or portable power supplies at the rear of the appliance.

To avoid contamination of food, please respect the following instructions

- Opening the door for long periods can cause a significant increase of the temperature in the compartments of the appliance.
- Clean regularly surfaces that can come in contact with food and accessible drainage systems.
- Clean water tanks if they have not been used for 48h; flush the water system connected to a water supply if water has not been drawn for 5 days.
- Store raw meat and fish in suitable containers in the refrigerator, so that it is not in contact with or drip onto other food.
- Two-star frozen-food compartments (if they are presented in the appliance) are suitable for storing pre-frozen food, storing or

making ice-cream and making ice cubes.

- One-, two- and three -star compartments (if they are presented in the appliance) are not suitable for the freezing of fresh food.
- If the appliance is left empty for long periods, switch off, defrost, clean, dry and leave the door open to prevent mould developing within the appliance.

WARNING! During using, service and disposal the appliance, please pay attention to symbol as left side, which is located on rear of appliance (rear panel or compressor). It's risk of fire warning symbol. There are flammable materials in refrigerant pipes and compressor.

Please be far away fire source during using, service and disposal.

Care and cleaning

- Before maintenance, switch off the appliance and disconnect the mains plug from the mains socket.
- Do not clean the appliance with metal objects.
- Do not use sharp objects to remove frost from the appliance. Use a plastic scraper."
- Regularly examine the drain in the refrigerator for defrosted water. If necessary, clean the drain. If the drain is blocked, water will collect in the bottom of the appliance."

Installation

Important! For electrical connection carefully follow the instructions given in specific paragraphs.

- Unpack the appliance and check if there are damages on it. Do not connect the appliance if it is damaged. Report possible damages immediately to the place you bought it. In that case retain packing.
- It is advisable to wait at least four hours before connecting the appliance to allow the oil to flow back in the compressor.
- Adequate air circulation should be around the appliance, lacking this leads to overheating. To achieve sufficient ventilation follow the instructions relevant to installation.
- Wherever possible the spacers of the product should be against a wall to avoid touching or catching warm parts (compressor, condenser) to prevent possible burn.
- The appliance must not be located close to radiators or cookers.
- Make sure that the mains plug is accessible after the installation of the appliance.
 - 1) IT triere is a treezer compartment.
 - 2) If there is a fresh-food storage compartment.

Service

- Any electrical work required to do the servicing of the appliance should be carried out by a qualified electrician or competent person.
- This product must be serviced by an authorized Service Center, and only genuine spare parts must be used.

Energy saving

- Don't put hot food in the appliance;
- Don't pack food close together as this prevents air circulating;
- Make sure food don't touch the back of the compartment(s);
- If electricity goes off, don't open the door(s);
- Don't open the door(s) frequently;
- Don't keep the door(s) open for too long time;
- Don't set the thermostat on exceeding cold temperatures;
- Some accessories, such as drawers, can be removed to get larger storage volume and lower energy consumption.

Environment Protection

® This does appliance not contain gasses which could damage the ozone layer, in either its refrigerant circuit or insulation materials. The

appliance shall not be discarded together with the urban refuse and rubbish. The insulation foam contains flammable gases; the appliance shall be disposed according to the appliance regulations to obtain from your local authorities. Avoid damaging the cooling unit, especially the heat exchanger. The materials used on this appliance marked by the symbol A are recyclable.

The symbol Kon the product on its packaging indicates that this product may not be treated as household waste. Instead it should be taken to the appropriate collection point for the recycling of electrical and electronic equipment. By ensuring this product is disposed of correctly, you will help prevent potential negative consequences for the environment and human health, which could otherwise be caused by inappropriate waste handling of this product. For more detailed information about recycling of this product, please contact your local council, your household waste disposal service or the shop where you purchased the product.

Packaging materials

The materials with the symbol are recyclable. Dispose the packaging in a suitable collection containers to recycle it.

SCRAPPING OLD APPLIANCES



This appliance is marked according to the European directive 2012/19/EU on Waste Electrical and Electronic Equipment (WEEE).

WEEE contains both polluting substances (which can cause negative consequences for the environment) and basic components (which can be re-used). It is important to have WEEE subjected to specific treatments, in order to remove and dispose properly all pollutants, and recover and recycle all materials.

Individuals can play an important role in ensuring that WEEE does not become an environmental issue; it is essential to follow some basic rules:

- WEEE should not be treated as household waste;
- WEEE should be handed over to the relevant collection points managed by the municipality or by registered companies. In many countries, for large WEEE, home collection could be present.

In many countries, when you buy a new appliance, the old one may be returned to the retailer who has to collect it free of charge on a one-to-one basis, as long as the equipment is of equivalent type and has the same functions as the supplied equipment.

Conformity

By placing the  mark on this product, we are confirming compliance to all relevant European safety, health and environmental requirements which are applicable in legislation for this product.

Energy Saving

For better energy saving we suggest:

Installing the appliance away from heat sources and not exposed to direct sunlight and in a well ventilated room.

Avoid putting hot food into the refrigerator to avoid increasing the internal temperature and therefore causing continuous functionaliting of the compressor.

Do not excessively stuff foods so as to ensure proper air circulation.

Defrost the appliance in case there is ice to facilitate the transfer of cold.

In case of absence of electrical energy, it is advisable to keep the refrigerator door closed. Open or keep the doors of the appliance open as little as possible

Avoid adjusting the setting to temperatures too cold.

Remove dust present on the rear of the appliance

Overview

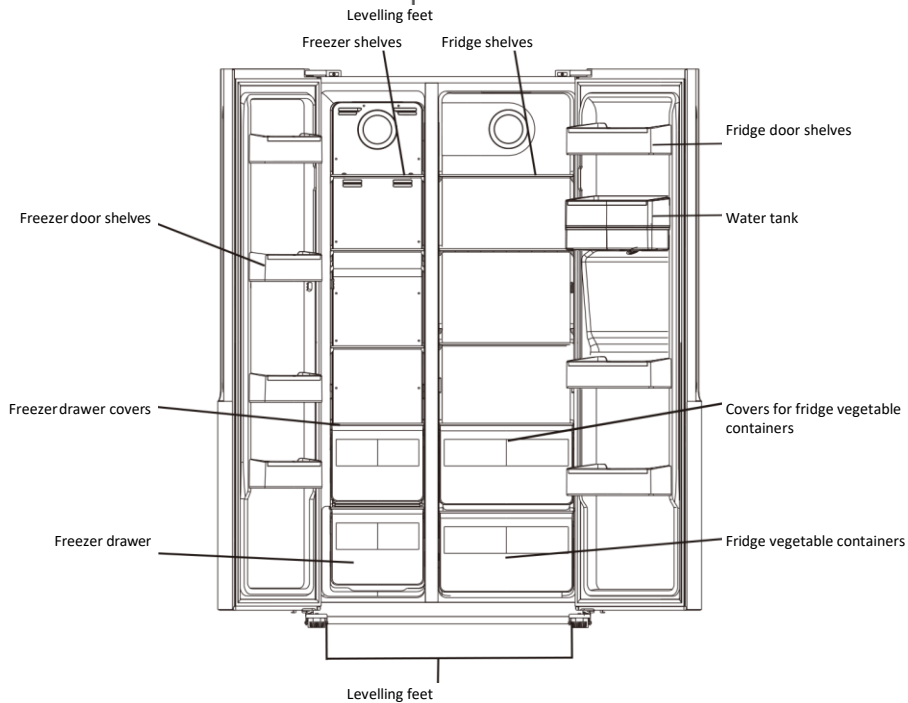
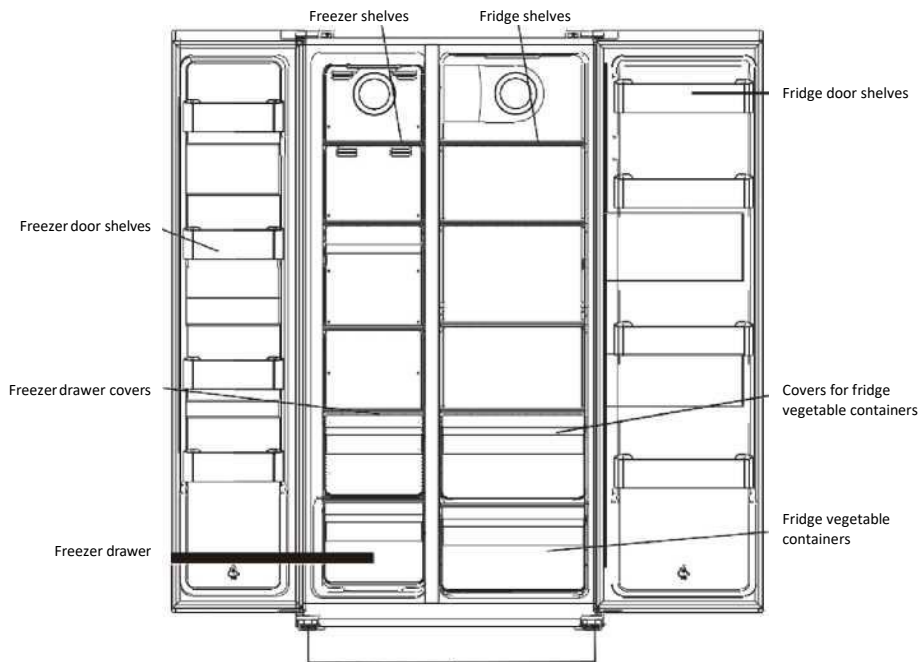

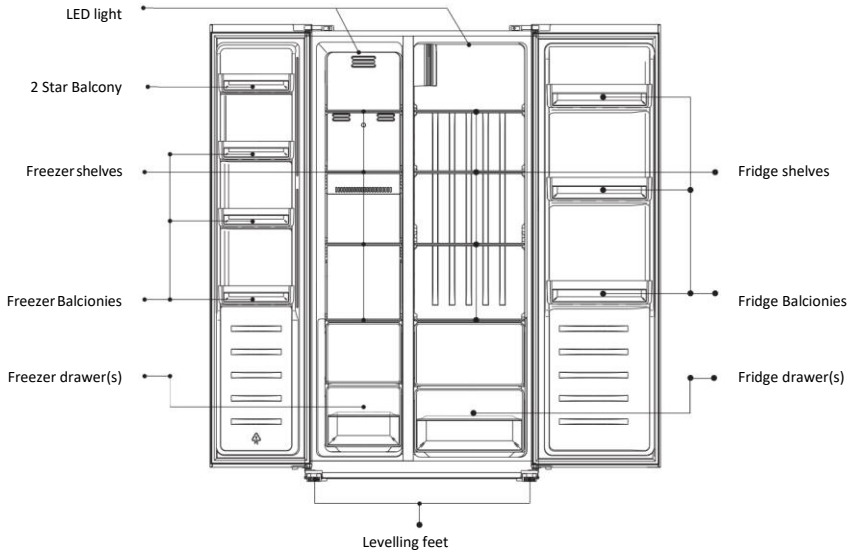

Note: Above picture is for reference only. Real appliance may be different.

Remove the doors

Tool required: Philips screwdriver, Flat bladed screwdriver.

- Ensure the unit is unplugged and empty.
- To take the door off, it is necessary to tilt the unit backwards. You should rest the unit on something solid so that it will not slip during the door removing process.
- All parts removed must be saved to do the reinstallation of the door.
- Do not lay the unit flat as this may damage the coolant system.
- It's better that 2 people handle the unit during assembly.

1. Unscrew hinge cover by Philips screwdriver.

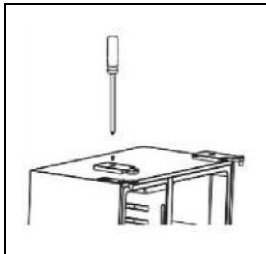

2. disconnect the harness.

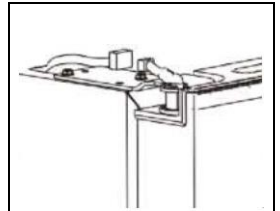

- Unscrew top hinge.

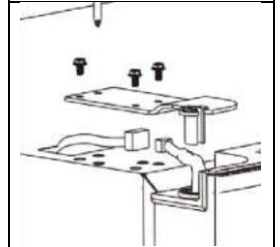

- Lift the door and place it on a soft pad. Then remove another door as same process



- Unscrew bottom hinges.

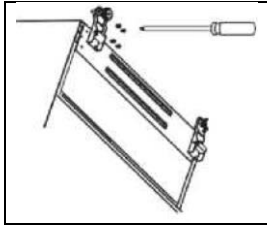

”. After the appliance is positioned! install the doors as reversed process.

Space Requirement

- Select a location without direct exposure to sunlight;
- Select a location with enough space for the refrigerator doors to open easily;
- Select a location with level (or nearly level) flooring;
- Allow sufficient space to install the refrigerator on a flat surface;
- Allow clearance to the right, left, back and top when installing. This will help reduce power consumption and keep your energy bills lower.

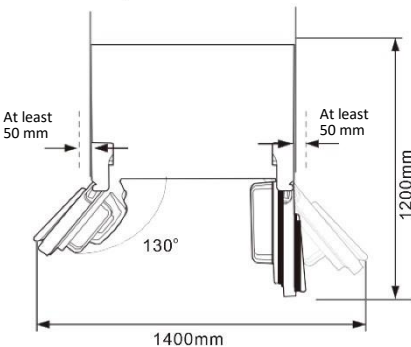
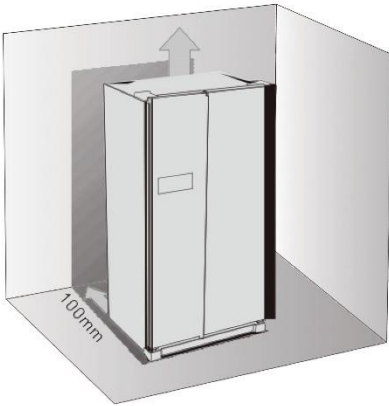

Levelling the refrigerator

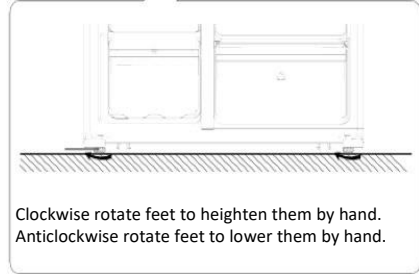

Positioning

Install this appliance at a location where the ambient temperature corresponds to the climate class indicated on the rating plate of the appliance:

Climate class	Ambient temperature
SN	+ 10°C to +32°C
N 1	+ 16°C to +32°C
ST	+ 16°C to +38°C
T	+ 16°C to +43°C

Location

The appliance should be installed well away from sources of heat such as radiators, boilers, direct sunlight etc. Ensure that air can circulate freely around the back of the cabinet. To ensure best performance, if the appliance is positioned below an overhanging wall unit, the minimum distance between the top of the cabinet and the wall unit must be at least 100 mm. Ideally, however, the appliance should not be positioned below overhanging wall units. Accurate leveling is ensured by one or more adjustable feet at the base of the cabinet, and the wall unit must be at least 100 mm. Ideally, however, the appliance should not be positioned below overhanging wall units. Accurate leveling is ensured by one or more adjustable feet at the base of the cabinet.



Warning! It must be possible to disconnect the appliance from the mains power supply; the plug must therefore be easily accessible after installation.

Electrical connection

Before plugging in, ensure that the voltage and frequency shown on the rating plate correspond to your domestic power supply. The appliance must be earthed. The power supply cable plug is provided with a contact for this purpose.

Daily use

Using the Control Panel

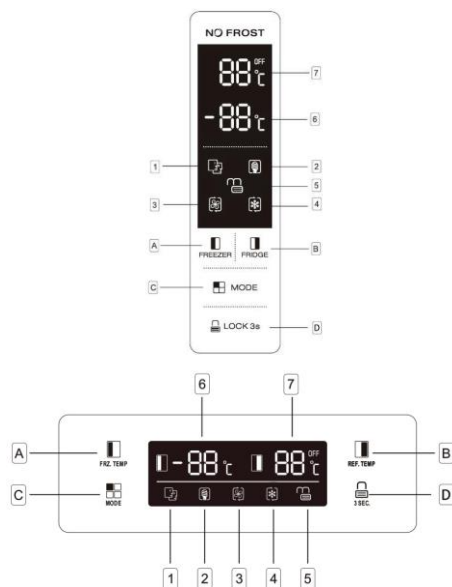

Buttons

- A** Press to adjust temperature of freezer compartment (left side) from 14 °C to 22 °C.
- B** Press to adjust temperature of fridge compartment (right side) from 2°C to 8°C and "OFF". If select "OFF", fridge compartment will be turned off

- C** Press to select running mode from **SMART**, **ECO**, **SUPER COOLING**; **SUPERFREEZING** and **USER'S SETTING** (no symbol in display).
- D** Press **3 SEC.** button and hold for 3 seconds to lock other three buttons. Press it and hold for 1 second to unlock other three buttons

Display

- 1** **SMART** mode, the refrigerator sets the temperature of two compartments automatically according to Ly internal temperature and ambient temperature.
- 2** **ECO** mode, the refrigerator runs in lowest energy consumption setting.
- 3** **SUPERCOOL !"** cools the fridge compartment to the lowest temperature for approx. 2 hours. Then Ly the temperature set before super mode is automatically restored.
- 4** **SUPERFREEZ !"** cools the freezer compartment to the lowest temperature for approx. 6 hours. Then the temperature set before super mode is automatically restored.
- 5** **LOCK**, the symbol will light on if buttons are locked.
- 6** Display the setting temperature of freezer compartment.
- 7** Display the setting temperature of fridge compartment.

Using the Water Dispenser" (If present).

Before using the water dispenser for the first time, remove and clean the water tank located inside the fridge compartment.

1. Lift and take off tank balcony first, then take off water tank with cover. Detach the cover to wash and clean the tank and cover.

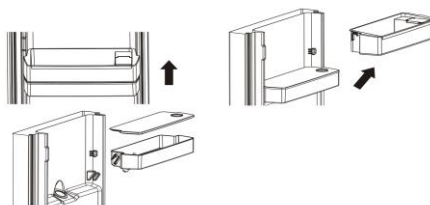

- After cleaning, reposition water tank, cover and tank balcony as below process.

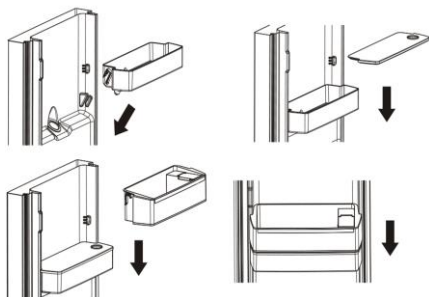

- Clean the dispenser pad outside the fridge door.



Filling the water tank with water

- Open the small lid



- Fill the water tank with drinkable water up to 3 L line.



- Close the small lid on the cover

Dispensing

To dispense water, push the dispenser pad gently, using a glass or container. To stop the flow of water, pull your glass away from the dispenser pad.

Door Open Alarm

If one door keeps open for 90 seconds, periodical alarm will be arisen until the door is closed.

Mode	Indicator light	Freezer temperature display	Fridge temperature display
Smart		The temperature display for freezer and fridge will change based on ambient temperature (see the table below).	
ECO		-15 °C	+8 °C
Super cooling		No change	+2 °C
Super freezing		-25 °C	No change

NOTES:

ECO mode: Select this mode when you want to save power.

Super cooling mode: This mode allows you to cool foods quickly and will be automatically deactivated after 50 hours of operation.

Super freezing mode: This mode allows you to freeze foods quickly and will be automatically deactivated after 50 hours of operation.

Door open alarm



When any door is left open or not closed completely for about 90 seconds, the appliance will sound an alarm. Close the fridge door then the alarm will stop.

If the door is not well closed, then the alarm will sound every 35 seconds until the doors are well closed. If doors are open for 10 continuous minutes without closing, the internal LED light would be turned off automatically.

Child safety lock

This function is designed to prevent children from operating the appliance.

- To activate the function, press and hold LOCK 3s for about 3 seconds. The lock indicator light will illuminate indicating the safety lock function is activated.

- To deactivate the function, press and hold  LOCK 3s for about 3 second. The unlock indicator light  will illuminate indicating the safety lock function is deactivated.

First use

Cleaning the interior

Before using the appliance for the first time, wash the interior and all internal accessories with lukewarm water and some neutral soap so as to remove the typical smell of a brand new product, then dry thoroughly.

Important! Do not use detergents or abrasive powders, as these will damage the finish.

Freezing fresh food

- The freezer compartment is suitable for freezing fresh food and storing frozen and deep-frozen food for a long time.
- Place the fresh food to be frozen in the bottom compartment.
- The maximum amount of food that can be frozen in 24 hours is specified on the rating plate.
- The freezing process lasts 24 hours: during this period do not add other food to be frozen

Storing frozen food

When first starting-up or after a period out of use. Before putting the product in the compartment let the appliance run at least 2 hours on the higher settings,

Important! In the event of accidental defrosting, for example the power has been off for longer than the value shown in the technical characteristics chart under “rising time”, the defrosted food must be consumed quickly or cooked immediately and then re-frozen (after cooked).

Thawing

Deep-frozen or frozen food, prior to be used, can be thawed in the freezer compartment at room temperature, depending on the time available for this operation.

Small pieces may even be cooked still frozen, directly from the freezer, in this case, cooking will take longer.

Ice-cube

This appliance may be equipped with one or more ice-cube to produce ice.

Accessories

Movable shelves

The walls of the refrigerator are equipped with a series of runners so that the shelves can be positioned as desired.



Positioning the door balconies

To permit storage of food packages of various sizes, the door balconies can be placed at different heights. To make these adjustments proceed as follows: gradually pull the balcony in the direction of the arrows until it comes free, then reposition as required.

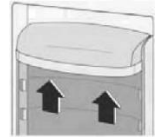

Helpful hints and tips

Hints for freezing

To help you make the most of the freezing process, here are some important hints:

- the maximum quantity of food which can be frozen in 24 hrs. is shown on the rating plate;
- the freezing process takes 24 hours No further food to be frozen should be added during this period;
- only freeze top quality, fresh and thoroughly cleaned, foodstuffs;
- prepare food in small portions to enable it to be rapidly and completely frozen and to make it possible subsequently to thaw only the quantity required;
- wrap up the food in aluminium foil or polythene and make sure that the packages are airtight;
- do not allow fresh, unfrozen food to touch food which is already frozen, thus avoiding a rise in temperature of the latter;
- lean foods store better and longer than fatty ones; salt reduces the storage life of food;
- water ices, if consumed immediately after removal from the freezer compartment, can possibly cause the skin to be freeze burnt;
- it is advisable to show the freezing in date on each individual pack to enable you removal from the freezer compartment, can possibly cause the skin to be freeze burnt;
- it is advisable to show the freezing in date on each individual pack to enable you to keep tab of the storage time.

Hints for storage of frozen food

To obtain the best performance from this appliance, you should;

- Make sure that the commercially frozen foodstuffs were adequately stored by the retailer;
- Be sure that frozen foodstuffs are transferred from the food store to the freezer in the shortest possible time;
- Do not open the door frequently or leave it open longer than absolutely necessary;
- Once defrosted, food deteriorates rapidly and cannot be refrozen;
- Do not exceed the storage period indicated by the food manufacture.

Hints for fresh food refrigeration

To obtain the best performance:

- Do not store warm food or evaporating liquids in the refrigerator
- Do cover or wrap the food, particularly if it has a strong flavour.

Hints for refrigeration

Useful hints:

- Make (all types); wrap in polythene bags and place on the glass shelves above the vegetable drawer.
- For safety, store in this way only one or two days at the most.
- Cooked foods, cold dishes, etc. these should be covered and may be placed on any shelf.
- Fruit and vegetables: these should be thoroughly cleaned and placed in the special drawer(s) provided.
- butter and cheese: these should be placed in special airtight containers or wrapped in aluminium foil or polythene bags to exclude as much air as possible.
- Milk bottle: these should have a cap and should be stored in the balconies on the door
- Bananas, potatoes, onions and garlic, if not packed, must not be kept in the fridge.

Cleaning

For hygienic reasons the appliance interior, in eluding interior accessories, should be cleaned regularly.



Caution! The appliance may not be connected to the mains during cleaning. Danger of electrical shock! Before cleaning switch the appliance off and remove the plug from the mains, or switch off or turn out the

circuit breaker or fuse. Never clean the appliance with a steam cleaner. Moisture could accumulate in electrical components, danger of electrical shock! Hot vapors can lead to the damage of plastic parts. The appliance must be dry before it is placed back into service.

Important! Ethereal oils and organic solvents can attack plastic parts, e.g. lemon juice or the juice from orange peel, butyric acid, cleanser that contain acetic acid.

- Do not allow such substances to come into contact the appliance parts.
- Do not use any abrasive cleaners
- Remove the food from the freezer. Store them in a cool place, well covered.
- Switch the appliance off and remove the plug from the mains, or switch off or turn out the circuit breaker or fuse
- Clean the appliance and the interior accessories with a cloth and lukewarm water. After cleaning wipe with fresh water and rub dry.
- After everything is dry place appliance back into service.

Troubleshooting



Caution! Before troubleshooting, disconnect the power supply. Only a qualified electrician of competent person must do the troubleshooting that is not in this manual.

Important! There are some sounds during normal use (compressor, refrigerant circulation).

If the malfunction shows again, contact the Service Center

These data are necessary to help you quickly and correctly. Write the necessary data here, refer to the rating plate.

Problem	Possible cause	Solution
Appliance does not work	Mains plug is not plugged in or is loose	Insert mains plug.
	Fuse has blown or is defective	Check fuse, replace if necessary.
Appliance freezes or cools too much	Socket is defective	Mains malfunctions are to be corrected by an electrician.

Problem	Possible cause	Solution
	Temperature is set too cold or the appliance runs at SUPER modes,	Turn the temperature regulator to a warmer setting temporarily.
The food is not frozen enough.	Temperature is not properly adjusted.	Please look in the initial Temperature Setting section.
	Door was open for an extended period.	Open the door only as long as necessary.
	A large quantity of warm food was placed in the appliance within the last 24 hours.	Turn the temperature regulation to a colder setting temporarily.
	The appliance is near a heat source.	Please look in the installation location section.
Heavy build up of frost on the door seal.	Door seal is not air tight.	Carefully warm the leaking sections of the door seal with a hair dryer (on a cool setting) At the same time shape the warmed door seal by hand such that it sits correctly.
Unusual noises	Appliance is not level.	Re-adjust the feet.
	The appliance is touching the wall or other objects.	Move the appliance slightly.
	A component, e.g. a pipe on the rear of the appliance is touching another part of the appliance or the wall.	If necessary, carefully bend the component out of the way
Side panels are hot	It's normal. Heat exchange is in the side panels.	Take gloves to touch side panels if need.

If the malfunction shows again, contact the Service Center.

These data are necessary to help you quickly and correctly. Write the necessary data here, refer to the rating plate.

Problém	Možná příčina	Riešenie
	Niektorá súčasť, napr. rúra na zadnej časti spotrebiča sa dotýka inej časti spotrebiča alebo steny.	Ak je to potrebné, opatrne ohnite súčasť tak, aby sa nedotýkali.
Bočné panely sú horúce.	Je to normálne. Výmenník tepla sa nachádza v bočných paneloch.	V prípade potreby použite na dotyk bočných panelov rukavice.

Ak sa porucha objaví znova, obráťte sa na servisné stredisko.

Tieto údaje sú potrebné na poskytnutie rýchlej a správnej pomoci. Podľa výkonnostného štítku sem zapíšte potrebné údaje.