



Russell Hobbs



24430

 www.russellhobbs.com

£10,000 prize draw

EXTRA year guarantee FREE rewards gallery

www.russellhobbs.co.uk/productregister/ Register online now! See back for details

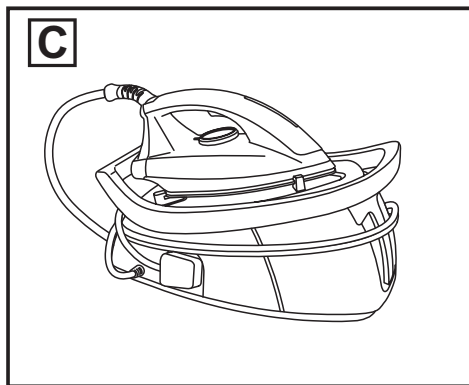
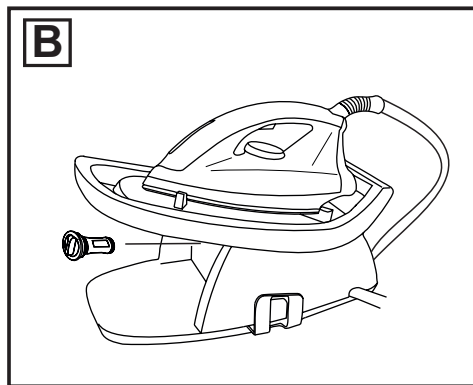
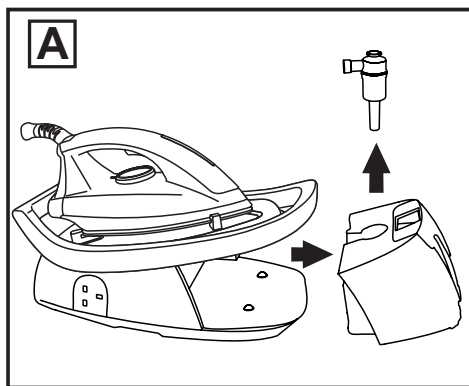
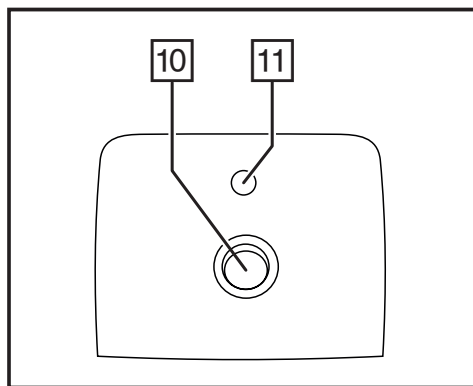
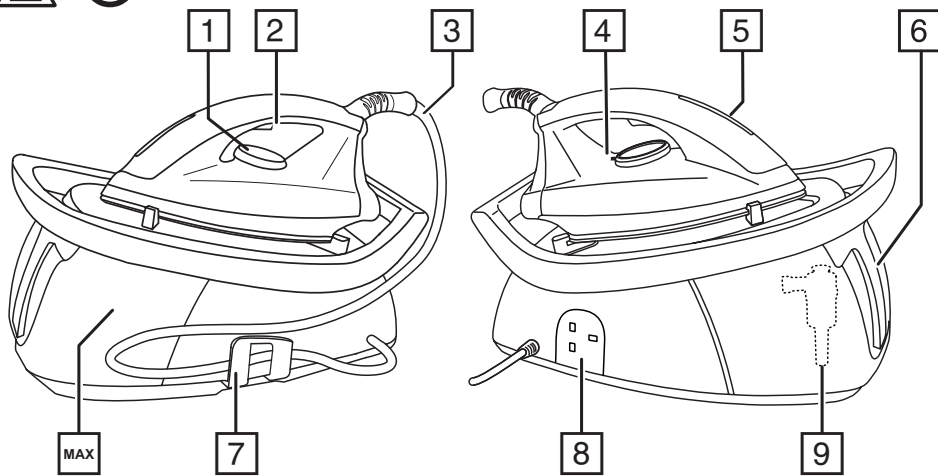



Read the instructions, keep them safe, pass them on if you pass the iron on.

IMPORTANT SAFEGUARDS

Follow basic safety precautions, including:

This appliance can be used by children aged from 8 years and above and persons with reduced physical, sensory or mental capabilities or lack of experience and knowledge if they have been supervised/instructed and understand the hazards involved. Children shall not play with the appliance. Cleaning and user maintenance shall not be done by children unless they are older than 8 and supervised. Keep the iron and cable out of reach of children under 8 years.

Sit the base unit on a stable, level, heat-resistant surface, preferably a purpose-built "steam generator" type ironing board.

Rest the iron only on the base unit.

Don't leave the iron unattended while plugged in or standing on the ironing board. It could be knocked over.

Don't use the iron if it's dropped, damaged, malfunctions or leaks.

If the cable is damaged, return the iron, to avoid hazard.

 The surfaces of the appliance will get hot.

 Don't put the iron in liquid, don't use it in a bathroom, near water, or outdoors.

- Route the cable so it doesn't overhang, and can't be tripped over or caught.
- Don't iron clothing while it's being worn – you'll burn or scald the wearer.
- Don't touch the soleplate, and keep away from the steam coming from it.
- Don't use the iron in the vicinity of children.
- Don't sit the base unit on a soft, carpeted, or upholstered surface, as this may block the vents underneath the base unit.
- Keep the cables and steam pipe away from hot parts.
- Don't use the iron for any purpose other than those described in these instructions.
- Take care not to scratch the soleplate – avoid buttons, zips, etc.
- The iron has a protective thermal fuse, which will blow if it overheats. If this happens, the iron will stop working, and must be returned for repair.

HOUSEHOLD USE ONLY

DIAGRAMS

- | | |
|------------------------|------------------------------------|
| 1. Temperature control | 7. Hose clip |
| 2. Steam trigger | 8. Plug storage |
| 3. Steam pipe | 9. Resin filter (inside reservoir) |
| 4. Mark | 10. On/off button |
| 5. Thermostat light | 11. Warning light/reset button |
| 6. Reservoir | |





BEFORE FIRST USE

- Remove any labels, stickers or packaging from the iron and soleplate.
- Before using the iron for the first time, or if it's not been used for a long time, iron a scrap piece of cotton (an old towel is ideal) to remove any accumulated residues.
- Don't worry if the iron smokes a bit at first, it will soon stop as the manufacturing residues evaporate.

FILLING/REFILLING

- Don't add anything to the water and don't use water with anything added to it. When the water is converted to steam, chemicals, perfume, and other additives will coat the inside of the steam chamber, shortening the life of the iron.
1. Remove the reservoir by pulling it away from the body of the steam generator using the grip on the front of the reservoir.
 2. Fill the reservoir to the **max** mark. Do not exceed the **max** mark.
 3. Refit the reservoir into the base unit.





PRELIMINARY SETTINGS

1. Put the iron on top of the base unit.
2. Put the plug into the power socket (switch the socket on, if it's switchable).
3. Turn the unit on by setting the on/off button to **I**.
4. Turn the temperature control to bring the setting you require next to the mark. The thermostat light will flash until the iron has reached its desired temperature. Once the temperature has been reached the light will remain on. **This will take 30-60 seconds after you first switch on your steam station.**

TEMPERATURE SELECTION GUIDE

1. Check for textile care symbols ().
2. Iron fabrics needing low temperatures first, then those that need medium temperatures, and finish with those needing high temperatures (or max).
3. Turn the temperature control to bring the setting you require next to the mark.

If the instructions on the fabric label differ from this guide, follow the instructions on the label.

Label marking	Dot setting
 cool – nylon, acrylics, polyester	•
 warm – wool, polyester mixtures	••
 hot – cotton, linen	•••/max
 do not iron	

When the soleplate reaches operating temperature, the thermostat light will stay permanently on.

STEAM IRONING

1. Set the temperature control to  or higher – otherwise the steam might condense on the soleplate, giving you water instead of steam.
2. Squeeze the steam trigger to produce steam, release it to stop.





NOTE: When you first start your steam station and pull the trigger for steam ironing, there will be a delay as your steam station pumps water from the reservoir to prime the system. This is normal and may take 20-30 seconds. This will also happen after refilling the reservoir.

DRY IRONING

You can dry iron by just not pressing the steam button, but if you want to make sure you don't press it accidentally, then you should iron with an empty reservoir. You can do your dry ironing first, then switch off, fill the reservoir and do your steam ironing.



VERTICAL STEAMING

Remove wrinkles from hanging clothes, hanging curtains, and furnishing fabrics.

- Check that there's adequate ventilation behind the fabric otherwise moisture may build up causing mildew.
- Check that there's nothing behind the fabric that may be damaged by the steam.
- Check that pockets, turn-ups, and cuffs are empty.
- 1. Check that the temperature control is at  or higher.
- 2. Hold the iron close to (but not touching) the fabric. Hold it well away for delicate fabrics.

We recommend using the steam trigger to produce steam for smaller areas, as it gives you better control.

AFTER USE

1. Put the iron on top of the base unit and turn the temperature control to .
2. Turn the unit off by setting the on/off button to .
3. Empty the reservoir.
4. Let the iron cool down completely before cleaning it, moving it, or storing it away.
5. The steam pipe can be coiled together and placed into the hose clip.
6. Wrap the mains cable around the steam generator in an anti-clockwise direction then slot the plug into the socket (Fig C).
7. The water reservoir must be emptied when storing your steam station vertically.

CARE AND MAINTENANCE

1. Unplug the base unit, and let the appliance cool down fully.
2. Wipe outer surfaces with a damp cloth. If necessary, use a little washing-up liquid.
3. Remove spots from the soleplate with a little vinegar.
4. Take care not to scratch the soleplate.

ANTI-SCALE CARTRIDGE

To extend the life of the appliance and to avoid problems with lime scale, your steam generator is fitted with an anti-scale cartridge. The life of the anti-scale cartridge depends on the frequency of use and the hardness of the water in your area. In a soft water area this should be about 100 uses. Do not put any descaling products (including vinegar) into the reservoir. This can damage the appliance.

To replace the cartridge:

1. Switch off and unplug your steam generator
2. Allow your steam generator to cool down for at least 1 hour until the soleplate is cold.
3. Remove the water tank from the front of the unit.



4. Pull the anti -scale cartridge vertically out of the water tank. Note that the cartridge may contain water when it is removed (Fig A).
5. Fit the new cartridge and push it down firmly into the water tank.
6. Refill and refit the water tank.
7. Plug in your steam generator.
8. Once the appliance is ready, pull the steam trigger until the steam is being produced. This will prime the system.

Important: Using the appliance without changing the cartridge can cause a reduction in the generated steam output and damage the appliance. The guarantee will not cover damage caused to the appliance by not changing the anti- scale cartridge when required.

REPLACEMENT ANTI-SCALE CARTRIDGES

1. Have the appliance **Model Number** to hand, as we won't be able to help you without it. It's on the rating plate (usually underneath the product).
2. Ring 0845 658 9700, or email service@russellhobbs.com, for prices, then purchase replacements using VISA or MASTERCARD.

FILTER

We recommend that you remove and clean the filter every 6 uses depending on the water hardness in your area. The warning light/reset button will flash to remind you that the filter needs cleaning. Doing this will extend the life of the unit.

To remove the filter:

1. Unplug the appliance and let it cool down.
2.  **Allow your steam generator to cool down for at least 1 hour until the soleplate is cold.**
3. Remove the reservoir from the front of the unit. The filter is behind the reservoir.
4. Turn the filter anticlockwise and remove it (Fig B).
5. Rinse the filter under a tap.
6. Refit the filter and tighten it firmly.
7. Reset the reminder light.





RECYCLING



To avoid environmental and health problems due to hazardous substances, appliances and rechargeable and non-rechargeable batteries marked with one of these symbols must not be disposed of with unsorted municipal waste. Always dispose of electrical and electronic products and, where applicable, rechargeable and non-rechargeable batteries, at an appropriate official recycling/collection point.

SERVICE

If you ring Customer Service, please have the appliance **Model Number** to hand, as we won't be able to help you without it. It's on the rating plate (usually underneath the product).

The product isn't user-serviceable. If it's not working, read the instructions, check the plug fuse and main fuse/circuit breaker. If it's still not working, consult your retailer.

If that doesn't solve the problem – ring Customer Service – they may be able to offer technical advice.

If they advise you to return the product to us, pack it carefully, include a note with your name, address, day phone number, and what's wrong. If under guarantee, say where and when purchased, and include proof of purchase (till receipt). Send it to:

Customer Service

Spectrum Brands (UK) Ltd

Fir Street, Failsworth, Manchester M35 0HS

email: support@russellhobbs.com

telephone: 0345 658 9700 (local rate number)

GUARANTEE

Defects affecting product functionality appearing within two years of first retail purchase will be corrected by replacement or repair provided the product is used and maintained in accordance with the instructions. Your statutory rights are not affected. Documentation, packaging, and product specifications may change without notice.

ONLINE

www.russellhobbs.co.uk for more products

REGISTER ONLINE FOR –



£10,000 prize draw,

EXTRA year guarantee,

FREE rewards gallery

Visit www.russellhobbs.co.uk/productregister/

You must register within 28 days of purchase.

