

# CV FOOT TO FLOOR

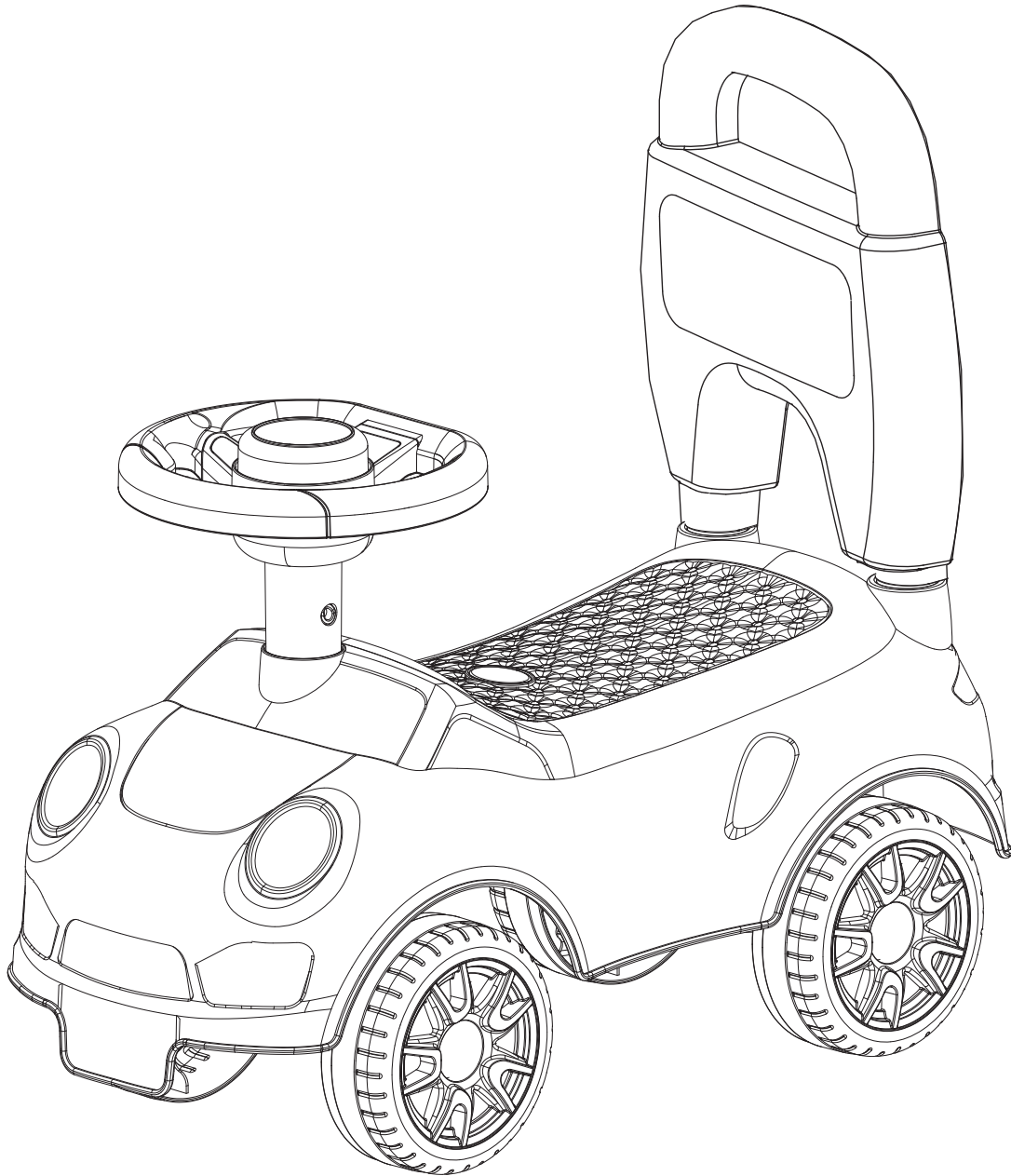

**Important**

Age: 12 months +

**Assembly & User Instructions - Please keep for future reference**

**7897041  
7941942**

These instructions contain important information which will help you get the best from your product and ensure safe and correct assembly, use and maintenance.



## Safety Information







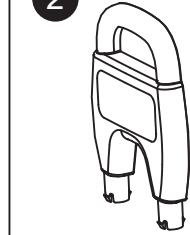
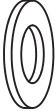

**Important - Please read these instructions fully before assembly or use**

### General Safety

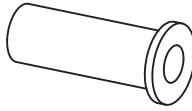
- Adult assembly is required.
- Maximum user weight 15kg.
- Do not allow children to play in the street.
- Prevent access to stairs, steps, uneven surfaces and slopes.
- Children must be supervised by an adult at all times when using this product.
- Do not use the ride-on toy near fires, heating and cooking appliances.
- Do not leave the ride-on toy outdoors. Protect it from weather conditions.
- For indoor/outdoor use only.
- Avoid collisions with walls, poles or other obstacles, as this may cause injury and/or damage to the ride-on.
- Care must be taken during unpacking and assembly due to small and potentially hazardous parts and packaging materials.
- An adult should carry out regular checks and maintenance of all main parts.
- Do not use if any parts/components are broken or missing.

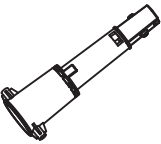
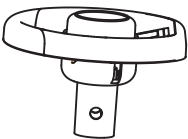
## Parts

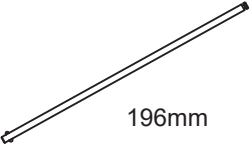
**Please check you have all the parts and fittings listed below**

 x1	 x1	 x4	 x4	 x2	 x2
 x1	 x1	 156mm x1	 196mm x1	 x1	 x4

# Assembly Instructions

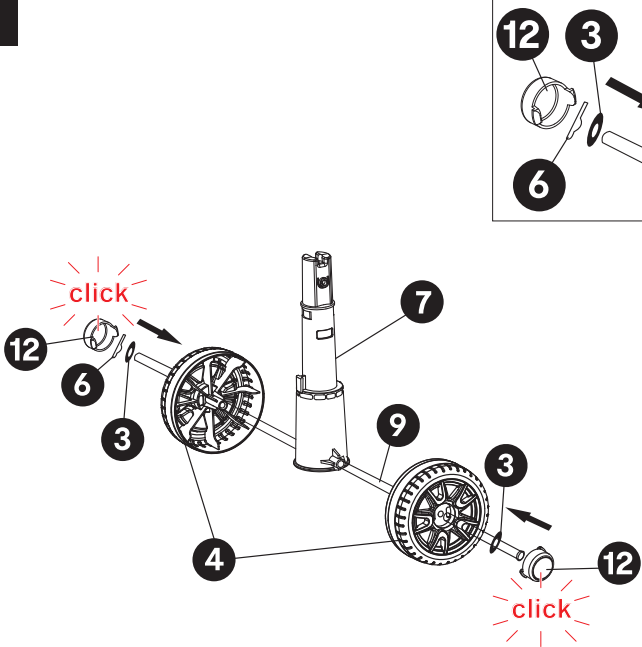
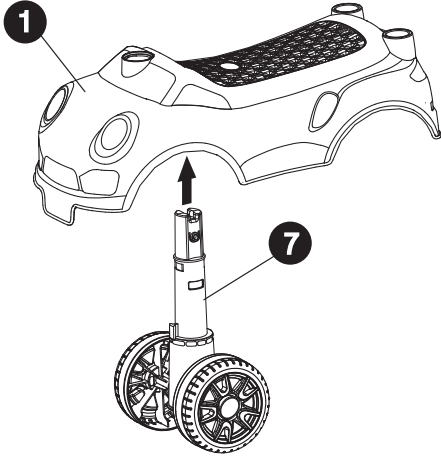
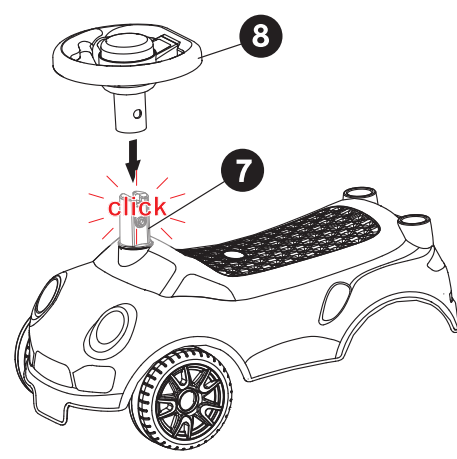
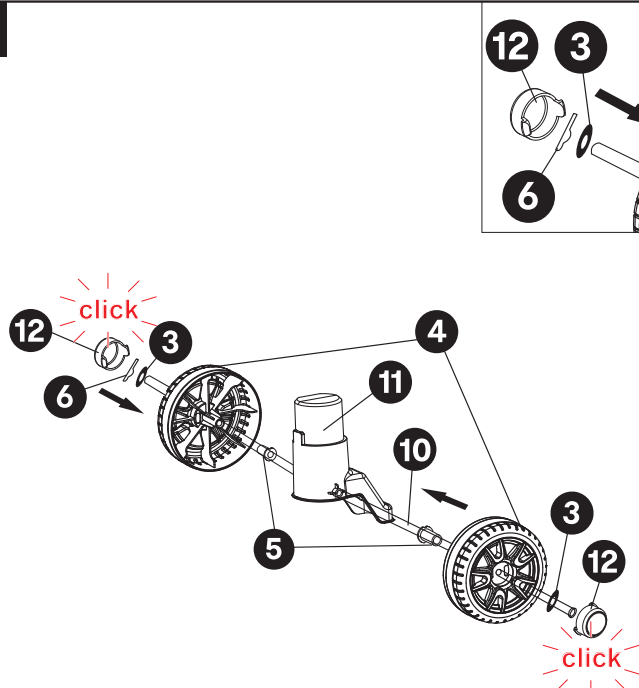
<p><b>1</b></p>  <p>1) Assemble all the components as per the image. Secure them in place with the locking washer <b>6</b> with an audible “Click” sound. Do not move to the next step until all the components are securely locked in place. Once assembled the components cannot be removed.</p>	<p><b>2</b></p>  <p>2) Ensure the steering lock is aligned with the corresponding slot in the main body <b>1</b>. Insert the assembled steering column <b>7</b> through the hole. Do not move to the next step until securely locked in place. Once assembled the parts cannot be removed.</p>
<p><b>3</b></p>  <p>3) Push the steering wheel <b>8</b> down onto the assembled steering column <b>7</b> ensuring that the steering wheel holes align with the steering column clips with an audible “Click” sound. Do not move to the next step until the components are securely locked in place. Once assembled the steering wheel cannot be removed.</p>	<p><b>4</b></p>  <p>4) Assemble all the components as per the image. Secure them in place with the locking washer <b>6</b> with an audible “Click” sound. Do not move to the next step until all the components are securely locked in place. Once assembled the components cannot be removed.</p>

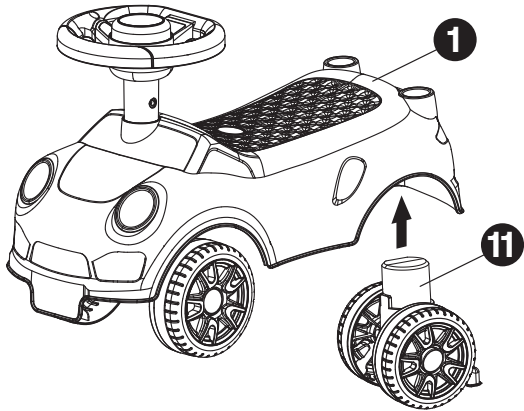
**5**

5) Insert the assembled rear axle **11** into the corresponding hole in the main body **1** with an audible “Click” sound. Do not move to the next step until the assembled axle is securely locked in place. Once assembled the axle cannot be removed.

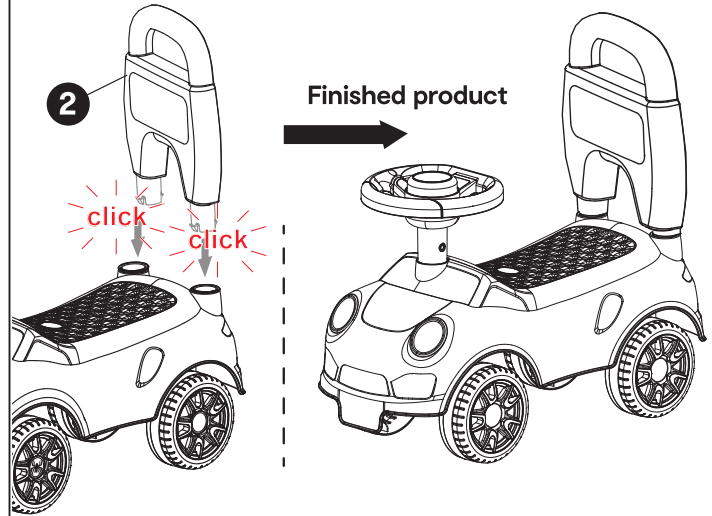
**6**

6) Push the handlebar **2** into the two corresponding holes on the main body with an audible “Click” sound. Once assembled the handlebar cannot be removed. Check that all components are securely locked before letting the child use the toy.

## Care and Maintenance

### General

1. Clean the product using a slightly damp cloth.
2. Keep the product clear of direct sunlight and any heat sources.

### Regular Safety Checks

Regularly inspect the pieces for cracks, deformations, or any other damages. This helps maintain the toy's integrity and ensures children's safety.



If you need help or have damaged or missing parts, call the Customer Helpline: 0345 640 2020  
 Produced in China for Argos Limited, London, EC1M 6HA, UK, Argos (N.I.) Ltd,  
 Forestside Shopping Centre, Upper Galwally, Belfast, BT8 6FX, UK.  
 Visit: [www.argos.co.uk/chadvalley](http://www.argos.co.uk/chadvalley)  
[argos.co.uk/help/contact-us](http://argos.co.uk/help/contact-us)