



# User Guide

## **SUMMARY**

This guide provides basic information for using and upgrading this product, including topics such as components, features, networks, and HP resources.

## Legal information

© Copyright 2024 HP Development Company, L.P.

Chrome, ChromeOS, Chromebook, Google, and Google Drive are trademarks of Google LLC. Windows is either a registered trademark or trademark of Microsoft Corporation in the United States and/or countries. USB Type-C® and USB-C® are registered trademarks of USB Implementers Forum.

First Edition: March 2024

Document Part Number: N91107-001

### Product notice

This guide describes features that are common to most models. Some features may not be available on your computer.

To help us improve this document, please send any suggestions, comments, or errors to <mailto:hp.doc.feedback@hp.com>. Include the document part number when submitting your feedback.

### Software terms

By installing, copying, downloading, or otherwise using any software product preinstalled on this computer, you agree to be bound by the terms of the HP End User License Agreement (EULA). If you do not accept these license terms, your sole remedy is to return the entire unused product (hardware and software) within 14 days for a full refund subject to the refund policy of your seller.

For any further information or to request a full refund of the price of the computer, please contact your seller.

## Safety warning notice

Reduce the possibility of heat-related injuries or of overheating the computer by following the practices described.

---

**⚠ WARNING!** To reduce the possibility of heat-related injuries or of overheating the computer, do not place the computer directly on your lap or obstruct the computer air vents. Use the computer only on a hard, flat surface. Do not allow another hard surface, such as an adjoining optional printer, or a soft surface, such as pillows or rugs or clothing, to block airflow. Also, do not allow the AC adapter to come into contact with the skin or a soft surface, such as pillows or rugs or clothing, during operation. The computer and the AC adapter comply with the user-accessible surface temperature limits defined by applicable safety standards.

---

---

# Table of contents





<b>1 About this guide</b>	<b>1</b>
<b>2 Components</b>	<b>2</b>
Right	2
Left	2
Display	3
Keyboard area	4
Touchpad	4
Speakers	5
Special keys	5
Action keys	6
Bottom	7
Labels	8
<b>3 Navigating the screen</b>	<b>10</b>
Using touchpad and touch screen gestures	10
Tap	10
Scrolling (touchpad only)	10
One-finger scrolling (touch screen only)	11
One-finger swipe (touch screen only)	11
Two-finger pinch zoom (touch screen only)	12
<b>4 Power and battery</b>	<b>13</b>
Factory-sealed battery	13
Charging the battery	13
<b>5 Printing</b>	<b>14</b>
Printing with built-in ChromeOS solution	14
Printing from Google Chrome	14
<b>6 Backing up, resetting, and recovering</b>	<b>15</b>
Backing up	15
Resetting	15
Recovering	15
Option 1: Recovering using an internet connection	16
Option 2: Installing the Chromebook Recovery Utility	16
Creating recovery media	16
Recovering the Chrome operating system with recovery media	17
Setting up your computer after a reset or recovery	17
Erasing and reformatting the recovery media	17

<b>7 More HP resources</b> .....	<b>19</b>
<b>8 Specifications</b> .....	<b>20</b>
Input power.....	20
Operating environment.....	21
<b>9 Electrostatic discharge</b> .....	<b>23</b>
<b>10 Accessibility</b> .....	<b>24</b>
HP and accessibility.....	24
Finding the technology tools you need.....	24
The HP commitment.....	24
International Association of Accessibility Professionals (IAAP).....	25
Finding the best assistive technology.....	25
Assessing your needs.....	25
Accessibility for HP products.....	25
Standards and legislation.....	26
Standards.....	26
Mandate 376 - EN 301 549.....	26
Web Content Accessibility Guidelines (WCAG).....	26
Legislation and regulations.....	27
Useful accessibility resources and links.....	27
Organizations.....	27
Educational institutions.....	27
Other disability resources.....	28
HP links.....	28
Contacting support.....	28
<b>Index</b> .....	<b>29</b>

---

# 1 About this guide

This guide provides basic information for using and upgrading this product.

- 
-  **WARNING!** Indicates a hazardous situation that, if not avoided, **could** result in serious injury or death.
  -  **CAUTION:** Indicates a hazardous situation that, if not avoided, **could** result in minor or moderate injury.
  -  **IMPORTANT:** Indicates information considered important but not hazard-related (for example, messages related to property damage). Warns the user that failure to follow a procedure exactly as described could result in loss of data or in damage to hardware or software. Also contains essential information to explain a concept or to complete a task.
  -  **NOTE:** Contains additional information to emphasize or supplement important points of the main text.
  -  **TIP:** Provides helpful hints for completing a task.
-

## 2 Components



Your computer features top-rated components. This chapter provides details about your components, where they are located, and how they work.

### Right

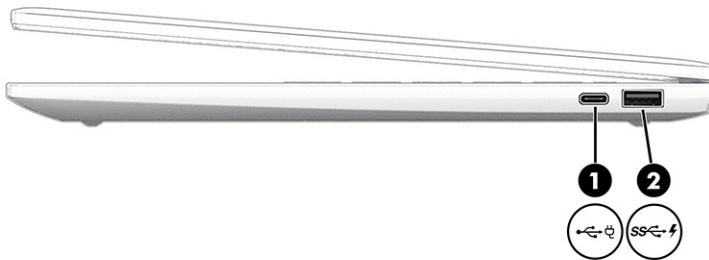
Use the illustration and table to identify the components on the right side of the computer.

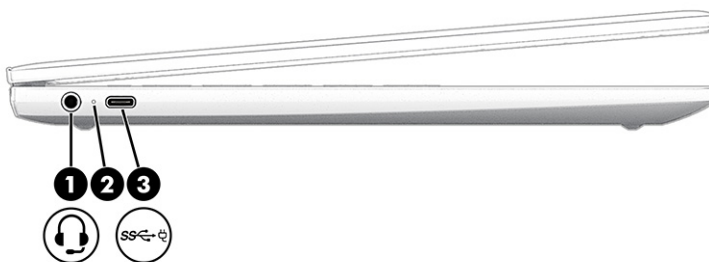

**Table 2-1** Right-side components and their descriptions



	Component	Description
(1)	 USB Type-C® power connector port*	Connects a USB device, provides data transfer, and charges small devices when the computer is on or in Sleep mode.  <b>NOTE:</b> *Select products only.  <b>NOTE:</b> Cables, adapters, or both (purchased separately) might be required.
(2)	 USB SuperSpeed charging port	Connects a USB device, provides data transfer, and (for select products) charges small devices when the computer is on or in Sleep mode.

### Left

Use the illustration and table to identify the components on the left side of the computer.

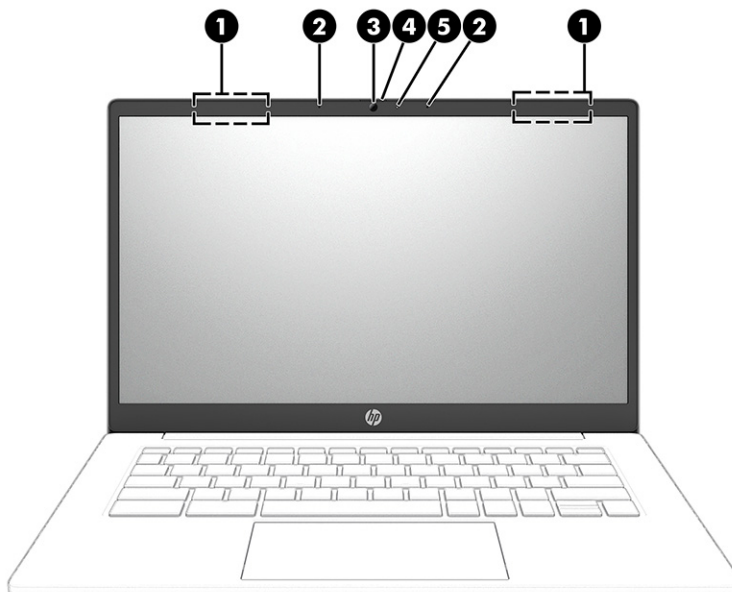

**Table 2-2** Left-side components and their descriptions

	Component	Description
(1)	 Audio-out (headphone)/Audio-in (microphone) combo jack	<p>Connects optional powered stereo speakers, headphones, earbuds, a headset, or a television audio cable. Also connects an optional headset microphone. This jack does not support optional standalone microphones.</p> <p><b>WARNING!</b> To reduce the risk of personal injury, adjust the volume before putting on headphones, earbuds, or a headset. For additional safety information, see the <i>Regulatory, Safety, and Environmental Notices</i>.</p> <p><b>NOTE:</b> When a device is connected to the jack, the computer speakers are disabled.</p>
(2)	 AC adapter and battery light	<ul style="list-style-type: none"> <li>• White: The AC adapter is connected and the battery is fully charged.</li> <li>• Amber: The AC adapter is connected and the battery is charging.</li> <li>• Blinking amber: The battery has an error.</li> <li>• Off: The battery is not charging.</li> </ul>
(3)	 USB Type-C® power connector port	<p>Connects a USB device, provides data transfer, and charges small devices when the computer is on or in Sleep mode.</p> <p><b>NOTE:</b> Second connector port on select products only.</p> <p>Cables, adapters, or both (purchased separately) might be required.</p>

## Display

Use the illustration and table to identify the components on the display.





**Table 2-3** Display components and their descriptions

	Component	Description
(1)	WLAN antennas* (2)	Send and receive wireless signals to communicate with wireless local area networks (WLANs).
(2)	Internal microphones (2)	Record sound.
(3)	Camera	Allows you to video chat, record video, and record still images.  <b>NOTE:</b> Camera functions vary depending on the camera hardware and software installed on your product.
(4)	Camera privacy cover	By default, the camera lens is uncovered, but you can slide the camera privacy cover to block the camera's view. To use the camera, slide the camera privacy cover in the opposite direction to reveal the lens.  <b>NOTE:</b> If you have both front-facing and rear-facing cameras, when one camera lens is revealed and ready to use, the other is concealed.
(5)	Camera light	On (white): The camera is in use.  On (amber): The camera is turned off by the switch.  Off: The camera is turned off by the software.

## Keyboard area

Keyboards can vary by language.

## Touchpad

The touchpad settings and components are described here.

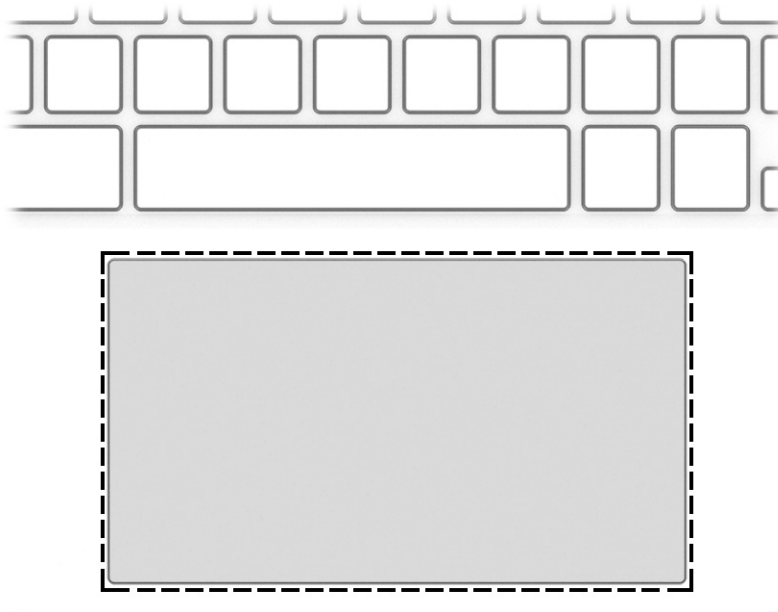

**Table 2-4** Touchpad component and description

Component	Description
Touchpad zone	Reads your finger gestures to move the pointer or activate items on the screen.

**NOTE:** For more information, see [Using touchpad and touch screen gestures on page 10](#).

## Speakers

Speakers are located on the right and left of the keyboard.

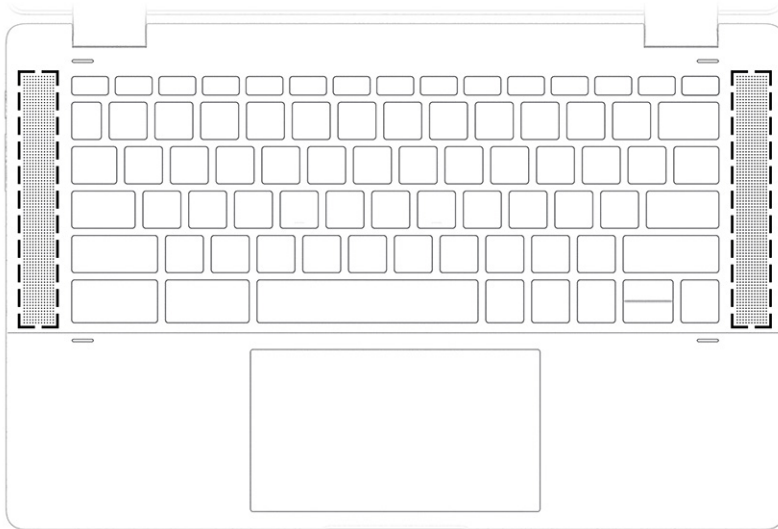
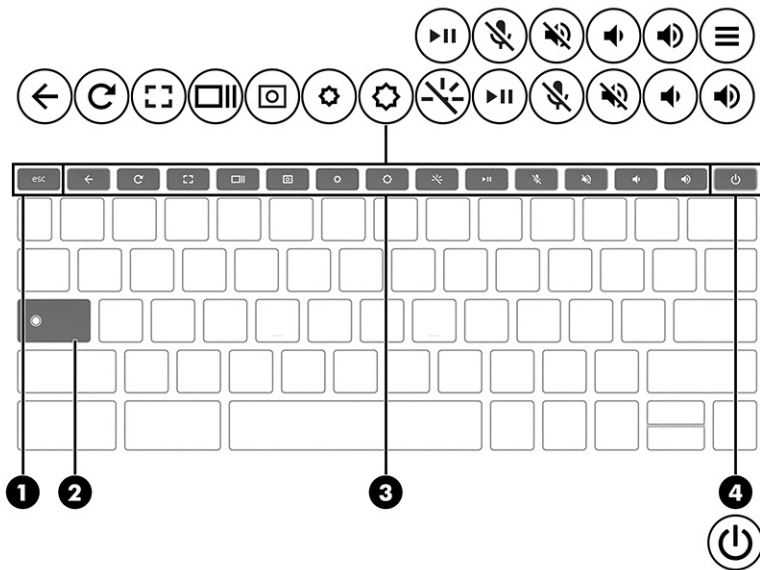

**Table 2-5** Speakers and their description

Component	Description
Speakers	Produce sound.

## Special keys

Use the illustration and table to locate the special keys.



**Table 2-6** Special keys and their descriptions

Component	Description
(1) <a href="#">esc</a> key	Activates certain computer functions when pressed in combination with other keys, such as <a href="#">tab</a> or <a href="#">shift</a> .
(2) Search key	Press to search your apps and the web from your apps list.
(3) Action keys	Execute frequently used system functions. <b>NOTE:</b> Exact action keys depends on product.
(4) Power key	<ul style="list-style-type: none"> <li>When the computer is off, press the key briefly to turn on the computer.</li> <li>When the computer is on, press and hold the key for 10 seconds to turn off the computer.</li> </ul> <p><b>IMPORTANT:</b> Pressing and holding down the power key results in the loss of unsaved information.</p> <p>If the computer has stopped responding and shutdown procedures are ineffective, press and hold the power key for at least 10 seconds to turn off the computer.</p>















## Action keys

Action keys perform specific functions and vary by computer. To determine which keys are on your computer, look at the icons on your keyboard and match them to the descriptions in this table.

- To use an action key, press and hold the key.

For more information about action keys and keyboard shortcuts, go to <https://support.google.com/chromebook/answer/183101>. Select your language at the bottom of the page.

**Table 2-7** Action keys and their descriptions

Icon	Key	Description
	Back	Displays the previous page in your browser history.
	Reload	Reloads your current page.
	Full screen	Opens your page in full-screen mode.
	Display apps	Displays open apps. <b>NOTE:</b> Pressing this button in conjunction with <b>ctrl</b> takes a screenshot.
	Screenshot	Takes a screenshot of your current computer screen.
	Brightness down	Decreases the screen brightness incrementally as long as you hold down the key.
	Brightness up	Increases the screen brightness incrementally as long as you hold down the key.
	Keyboard backlight	Turns the keyboard backlight off or on. <b>NOTE:</b> Select products only.
	Play/Pause	Starts, pauses, or resumes playback.
	Mute mic on	Mutes the microphone.
	Mute	Mutes speaker sound.
	Volume down	Decreases speaker volume incrementally as long as you hold down the key.
	Volume up	Increases speaker volume incrementally as long as you hold down the key.
	Menu	Opens the Chrome menu. <b>NOTE:</b> Select products only.

## Bottom

Use the illustration and table to identify the bottom components.



**Table 2-8** Bottom component and description

Component	Description
Vent	Enables airflow to cool internal components.  <b>NOTE:</b> The computer fan starts automatically to cool internal components and prevent overheating. It is normal for the internal fan to cycle on and off during routine operation.

## Labels

The labels affixed to the computer provide information you might need when you troubleshoot system problems or travel internationally with the computer. Labels might be in paper form or imprinted on the product.

**IMPORTANT:** Check the following locations for the labels described in this section: the bottom of the computer, inside the battery bay, under the service door, on the back of the display, or on the bottom of a tablet kickstand.

- Service label—Provides important information to identify your computer. When contacting support, you might be asked for the serial number, the product number, or the model number. Locate this information before you contact support.

Your service label will resemble one of the following examples. Refer to the illustration that most closely matches the service label on your computer.

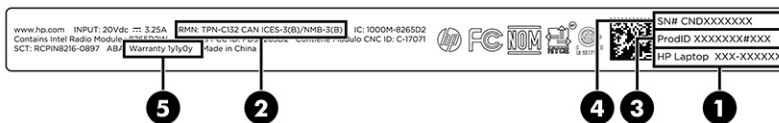

**Table 2-9 Service label components**

Component	
(1)	HP product name
(2)	Regulatory model number
(3)	Product ID
(4)	Serial number
(5)	Warranty period

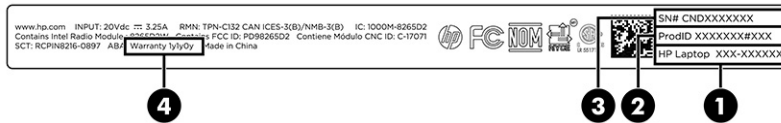

**Table 2-10 Service label components**

Component	
(1)	HP product name
(2)	Product ID
(3)	Serial number
(4)	Warranty period

- Regulatory labels—Provide regulatory information about the computer.
- Wireless certification labels—Provide information about optional wireless devices and the approval markings for the countries or regions where the devices have been approved for use.

---

## 3 Navigating the screen

Depending on your computer model, you can navigate the computer screen using one or more methods.

- Use touch gestures directly on the computer screen.
- Use touch gestures on the touchpad.

### Using touchpad and touch screen gestures

The touchpad helps you navigate the computer screen and control the pointer using simple touch gestures. To navigate a touch screen (select products only), touch the screen directly using gestures described in this chapter.

#### Tap

Use the tap or double-tap gesture to select or open an item on the screen.

- Point to an item on the screen, and then tap one finger on the touchpad zone or touch screen to select the item. Double-tap to open it.



- Tap two fingers on the touchpad zone or touch screen to bring up a context-sensitive menu.

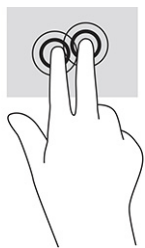

#### Scrolling (touchpad only)

Scrolling is useful for moving up, down, or sideways on a page or image. Scrolling to the left or the right with two fingers scrolls the screen, if there is more content viewable to either side, or moves back and forth through web browser history.

- Place two fingers slightly apart on the touchpad zone, and then drag them up, down, left, or right.



**NOTE:** Scrolling speed is controlled by finger speed.

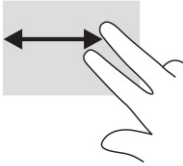

- To scroll between open tabs in Chrome™, slide three fingers left or right on the touchpad zone.

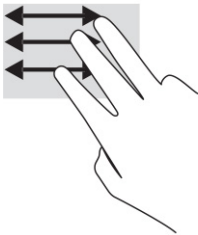

## One-finger scrolling (touch screen only)

Scrolling to the left or the right with one finger moves back and forth through web browser history.

- Place one finger on the touch screen, and then drag it across the touch screen in a left or right motion.

---

 **NOTE:** Scrolling speed is controlled by finger speed.

---



## One-finger swipe (touch screen only)

Swiping up with one finger hides or shows your shelf. The shelf contains a list of popular shortcuts to apps so that you can find them easily.

- Place your finger on the bottom of the screen, quickly slide your finger up a short distance, and then lift it.



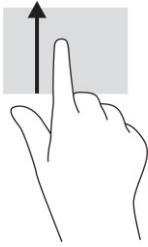

## Two-finger pinch zoom (touch screen only)

Use the two-finger pinch zoom to zoom out or in on images or text.

- Zoom out by placing two fingers apart on the touch screen and then moving your fingers together.
- Zoom in by placing two fingers together on the touch screen and then moving your fingers apart.

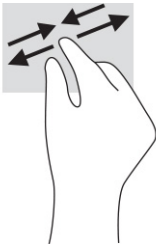

---

## 4 Power and battery

Your computer can operate on either battery power or external power. When the computer is running on battery power and an external power source is not available to charge the battery, it is important to monitor and conserve the battery charge.

### Factory-sealed battery

You cannot easily replace the battery in this product. Removing or replacing the battery could affect your warranty coverage. If a battery is no longer holding a charge, contact support.

When a battery reaches the end of its useful life, do not dispose of the battery in general household waste. Follow the local laws and regulations in your area for battery disposal.

### Charging the battery

When you connect the computer to external power, the battery begins to charge, and the Power icon changes appearance.

1. Connect the AC adapter to the computer.
2. Verify that the battery is charging by checking the AC adapter and battery light. This light is located on either the right or left side of the computer, next to the power connector.

**Table 4-1 AC adapter light and status description**

AC adapter light	Status
White	The AC adapter is connected and the battery is charged.
Amber	The AC adapter is connected and the battery is charging.
Off	The computer is using battery power.

3. While the battery is charging, keep the AC adapter connected until the AC adapter and battery light turns white.

---

# 5 Printing

You have several ways to print from your computer.

- Print with built-in ChromeOS solution.
- Print from Google Chrome using the HP Print for Chrome app.



**NOTE:** If you use HP Print for Chrome, you cannot register the printer with the Google ChromeOS printing solution.

---

## Printing with built-in ChromeOS solution

Google Chrome has a built-in printing solution for Chromebooks. HP printers produced in 2017 and later are supported automatically. For more information, see the Google Chrome support website.

1. Go to <https://support.google.com/chrome>.
2. Select the search icon, type `set up printer`, and then select **Set up printer**.



**NOTE:** Do not press `enter`.

---

3. Follow the on-screen instructions.

## Printing from Google Chrome

For an alternate method to print from Google Chrome, use the HP Print for Chrome app. You can install the HP Print for Chrome app from the Chrome Web Store. For more information, see the HP website.

1. Go to <http://www.hp.com/support>.
2. Select the search icon at the upper right of the page, type `Printing with the HP Print for Chrome App`, and then press `enter`.
3. Follow the on-screen instructions.

---

## 6 Backing up, resetting, and recovering

This chapter provides information about the standard procedures of backing up your personal data, resetting your computer to original factory conditions, and recovering your operating system.

### Backing up

You can back up your data to an optional USB flash drive or SD memory card or through Google Drive™.

For detailed information about creating a backup, go to <http://www.support.google.com>.

### Resetting

A factory reset erases the information on your computer hard drive, including files in the Downloads folder. Before you reset, back up your files to an optional USB flash drive, to an SD memory card, or through Google Drive. The factory reset will not delete your files at these locations.

You might want to reset your computer in the following circumstances:

- You see the message "Reset this Chrome device."
- You are having problems with your user profile or settings.
- You restarted your computer, and it still doesn't work properly.
- You want to change the owner of your computer.

To reset your computer:

1. Under the **Settings** menu, select **Advanced**.
2. In the **Powerwash** section, select **Powerwash**.
3. Select **Restart**.
4. In the window that appears, select **Powerwash**, and then select **Continue**.
5. Follow the on-screen instructions to reset your computer, and sign in with your Google Account.



**NOTE:** The account you sign in with after you reset your computer is recognized as the owner account.

---

6. After you complete the reset, you can set up your computer and check to see whether the problem is fixed.

### Recovering

When your ChromeOS™ doesn't work properly, you can perform a recovery. A recovery reinstalls the operating system, software programs, and original factory settings. It deletes locally saved files and saved networks for all accounts. A system recovery does not affect Google Accounts and data synced to Google Drive.

---

 **IMPORTANT:** Recovery permanently erases everything on your computer hard drive, including your downloaded files. If possible, back up your files before you recover your computer.

 **NOTE:** For more information about performing a system recovery on your computer, go to <http://www.support.google.com>.

---

Before you begin the recovery process, you need the following prerequisites:

- A USB flash drive or SD memory card with a capacity of 4 GB or greater. All data is erased from this storage device when the recovery media is created, so back up all files from the device before you begin.
- A computer with internet access. You must also have administrative rights to the computer.
- A computer AC adapter. The computer must be plugged into AC power during recovery.
- The “ChromeOS is missing or damaged” screen displaying on your computer. If this message is not already displayed:
  - Turn on the computer, press and hold the **esc+f3** keys, and then press the power button. The computer restarts, and the screen shows the “ChromeOS is missing or damaged” screen.

## Option 1: Recovering using an internet connection

Use these instructions to recover the Chrome operating system on your computer without recovery media:

1. Disconnect any external devices connected to your computer, plug in the power cord, and then turn on the computer.
2. To enter recovery mode, press and hold the **esc+f3** keys, and then press the power button. When the “ChromeOS is missing or damaged” screen appears, select **Recover using internet connection** and follow the on-screen instructions.

---

 **NOTE:** The computer must have internet access.

---

3. When the “System Recovery is complete” message appears, reboot your computer.

The computer restarts with ChromeOS reinstalled.

## Option 2: Installing the Chromebook Recovery Utility

The Chromebook™ Recovery Utility recovers the original operating system and software programs that were installed at the factory. You can install this utility from the Chrome Web Store on any computer.

---

 **NOTE:** Use this option if you do not have Internet access on your computer.

---

To install the Chromebook Recovery Utility:

- Open the Chrome Web Store, search for `chrome recovery`, select **Chromebook Recovery Utility** from the Apps list, and follow the on-screen instructions.

## Creating recovery media

You can use recovery media to recover the original operating system and software programs that were installed at the factory.

To create recovery media:

1. Turn on a computer that has internet access.

---

 **NOTE:** You must have administrative rights to the computer.

---

2. Select the **Launcher** icon, and then select **All Apps**.
3. In the Apps window, select **Recovery**, and then select **Get started**.
4. Follow the on-screen instructions to create the recovery media.

---

 **NOTE:** All data and partitions on your recovery media will be deleted. Do not remove the USB flash drive or SD memory card until the process is complete.

---

## Recovering the Chrome operating system with recovery media

Use these instructions to recover the Chrome operating system on your computer using the recovery media that you created.

1. Disconnect any external devices connected to your computer, plug in the power cord, and then turn on the computer.
2. To enter recovery mode, press and hold **esc+f3**, and then press the power button. When the “ChromeOS is missing or damaged” screen appears, insert the recovery media into your computer. The recovery process begins immediately.
3. Wait while Chrome verifies the integrity of the recovery media.

---

 **NOTE:** If you need to cancel the recovery during the verification process, press and hold the power button until the computer turns off. Do not disrupt the system recovery process after the verification step is complete.

 **NOTE:** If an error message is displayed, you might need to run the Chrome Recovery Utility again or use a different USB flash drive or SD memory card.

---

4. When the “System Recovery is complete” message appears, remove the recovery media.  
The computer restarts with ChromeOS reinstalled.

## Setting up your computer after a reset or recovery

After a reset or recovery is complete, perform the initial setup process.

For details about setting up the computer, go to <http://www.support.google.com>.

## Erasing and reformatting the recovery media

When you create recovery media, the USB flash drive or SD memory card is formatted as a recovery tool. After recovery, you must erase the recovery media to reuse your storage device. Follow these steps to use the Chromebook Recovery Utility to erase the recovery media.

1. Select the **Launcher** icon, and then select **All Apps**.
2. In the apps window, select **Recovery**.
3. Select the **Settings** icon, and then select **Erase recovery media**.

4. Select the USB flash drive or SD memory card that you inserted, select **Continue**, and then select **Erase now**.
5. After the recovery media is erased, select **Done** to close the Chromebook Recovery Utility, and then remove the USB flash drive or SD memory card.

The media is ready to be formatted using a formatting tool provided by your operating system.

# 7 More HP resources

To locate resources that provide product details, how-to information, and more, use this table.

**Table 7-1 Additional information**

Resource	Contents
<i>Setup Instructions</i>	<ul style="list-style-type: none"> <li>• How to set up the computer</li> <li>• Help to identify computer components</li> </ul>
<p><i>HP Support Assistant</i> app (select products only)</p> <p>Install HP Support Assistant to get access to HP tools and troubleshooting for printers and peripherals. Go to the <b>Chrome Web Store</b> and install the HP Support Assistant app.</p>	<ul style="list-style-type: none"> <li>• Optimizes computer performance and resolves problems using the latest software updates, diagnostic tools, and guided assistance</li> </ul>
<p>HP website</p> <p>To access the latest user guide, go to <a href="http://www.hp.com/support">http://www.hp.com/support</a>, and follow the instructions to find your product. Then select <b>Setup &amp; User Guides</b>.</p>	<ul style="list-style-type: none"> <li>• Support information</li> <li>• Ordering parts and finding additional help</li> <li>• Accessories available for the device</li> </ul>
<p>Worldwide support</p> <p>To get support in your language, go to <a href="http://www.hp.com/support">http://www.hp.com/support</a>, and select your country.</p>	<ul style="list-style-type: none"> <li>• Online chat with an HP technician</li> <li>• Support telephone numbers</li> <li>• HP service center locations</li> </ul>
<p><i>Safety &amp; Comfort Guide</i></p> <p>Go to <a href="http://www.hp.com/ergo">http://www.hp.com/ergo</a>.</p>	<ul style="list-style-type: none"> <li>• Proper workstation setup</li> <li>• Guidelines for posture and work habits that increase comfort and decrease risk of injury</li> <li>• Electrical and mechanical safety information</li> </ul>
<p><i>Regulatory, Safety, and Environmental Notices</i></p> <p>This guide is provided in the box.</p>	<ul style="list-style-type: none"> <li>• Regulatory and safety information</li> <li>• Battery disposal information</li> </ul>
<p><i>Limited Warranty*</i></p> <p>Go to <a href="http://www.hp.com/go/orderdocuments">http://www.hp.com/go/orderdocuments</a>.</p>	<ul style="list-style-type: none"> <li>• Warranty information</li> </ul>

\*You can find your HP Limited Warranty located with the user guides on your product and/or on the CD or DVD provided in the box. In some countries or regions, HP may provide a printed warranty in the box. For countries or regions where the warranty is not provided in printed format, you can request a copy from <http://www.hp.com/go/orderdocuments>. For products purchased in Asia Pacific, you can write to HP at POD, PO Box 161, Kitchener Road Post Office, Singapore 912006. Include your product name, and your name, phone number, and postal address.



---

## 8 Specifications

When you travel with or store your computer, the input power ratings and operating specifications provide helpful information.

### Input power

The power information in this section might be helpful if you plan to travel internationally with the computer.

The computer operates on DC power, which can be supplied by an AC or a DC power source. The AC power source must be rated at 100 V to 240 V, 50 Hz to 60 Hz. Although the computer can be powered from a standalone DC power source, it should be powered only with an AC adapter or a DC power source supplied and approved by HP for use with this computer.

The computer can operate on DC power within one or more of the following specifications. The voltage and current for your computer is located on the regulatory label.

**Table 8-1 DC power specifications**

Input Power	Rating
Operating voltage and current	5 V DC @ 3 A / 9 V DC @ 3 A / 12 V DC @ 2.5 A / 15 V DC @ 2 A - 30 W USB-C*
	5 V DC @ 2 A / 12 V DC @ 3 A / 15 V DC @ 3 A - 45 W USB-C
	5 V DC @ 3 A / 9 V DC @ 3 A / 12 V DC @ 3.75 A / 15 V DC @ 3 A - 45 W USB-C
	5 V DC @ 3 A / 9 V DC @ 3 A / 10 V DC @ 3.75 A / 12 V DC @ 3.75 A / 15 V DC @ 3 A / 20 V DC @ 2.25 A - 45 W USB-C
	5 V DC @ 3 A / 9 V DC @ 3 A / 12 V DC @ 5 A / 15 V DC @ 4.33 A / 20 V DC @ 3.25 A - 65 W USB-C
	5 V DC @ 3 A / 9 V DC @ 3 A / 10 V DC @ 5 A / 12 V DC @ 5 A / 15 V DC @ 4.33 A / 20 V DC @ 3.25 A - 65 W USB-C
	5 V DC @ 3 A / 9 V DC @ 3 A / 10 V DC @ 5 A / 12 V DC @ 5 A / 15 V DC @ 5 A / 20 V DC @ 4.5 A - 90 W USB-C
	5 V DC @ 3 A / 9 V DC @ 3 A / 12 V DC @ 5 A / 15 V DC @ 5 A / 20 V DC @ 5 A / 5 V DC USB-A port @ 2 A - 100 W USB-C + 10 W USB-A
	19.5 V DC @ 2.31 A - 45 W
	19.5 V DC @ 3.33 A - 65 W
	19.5 V DC @ 4.62 A - 90 W
	19.5 V DC @ 6.15 A - 120 W
	19.5 V DC @ 6.9 A - 135 W
	19.5 V DC @ 7.70 A - 150 W
19.5 V DC @ 10.3 A - 200 W	
19.5 V DC @ 11.8 A - 230 W	
19.5 V DC @ 16.92 A - 330 W	
20 V DC @ 14 A - 280 W	

 **NOTE:** This product is designed for IT power systems in Norway with phase-to-phase voltage not exceeding 240 V rms.

## Operating environment

Use the operating specifications for helpful information when you travel with or store your computer.

**Table 8-2 Operating environment specifications**

Factor	Metric	U.S.
<b>Temperature</b>		
Operating	5°C to 35°C	41°F to 95°F
Nonoperating	-20°C to 60°C	-4°F to 140°F

**Table 8-2** Operating environment specifications (continued)

<b>Factor</b>	<b>Metric</b>	<b>U.S.</b>
<b>Relative humidity</b> (noncondensing)		
Operating	<b>10% to 90%</b>	10% to 90%
Nonoperating	<b>5% to 95%</b>	5% to 95%
<b>Maximum altitude</b> (unpressurized)		
Operating	<b>-15 m to 3,048 m</b>	-50 ft to 10,000 ft
Nonoperating	<b>-15 m to 12,192 m</b>	-50 ft to 40,000 ft

---

## 9 Electrostatic discharge

Electrostatic discharge is the release of static electricity when two objects come into contact—for example, the shock you receive when you walk across the carpet and touch a metal door knob.

A discharge of static electricity from fingers or other electrostatic conductors may damage electronic components.

---

 **IMPORTANT:** To prevent damage to the computer, damage to a drive, or loss of information, observe these precautions:

- If removal or installation instructions direct you to unplug the computer, first be sure that it is properly grounded.
  - Keep components in their electrostatic-safe containers until you are ready to install them.
  - Avoid touching pins, leads, and circuitry. Handle electronic components as little as possible.
  - Use nonmagnetic tools.
  - Before handling components, discharge static electricity by touching an unpainted metal surface.
  - If you remove a component, place it in an electrostatic-safe container.
-

---

# 10 Accessibility

HP's goal is to design, produce, and market products, services, and information that everyone everywhere can use, either on a standalone basis or with appropriate third-party assistive technology (AT) devices or applications.

## HP and accessibility

Because HP works to weave diversity, inclusion, and work/life into the fabric of the company, it is reflected in everything HP does. HP strives to create an inclusive environment focused on connecting people to the power of technology throughout the world.

## Finding the technology tools you need

Technology can unleash your human potential. Assistive technology removes barriers and helps you create independence at home, at work, and in the community. Assistive technology helps increase, maintain, and improve the functional capabilities of electronic and information technology.

For more information, see [Finding the best assistive technology on page 25](#).

## The HP commitment

HP is committed to providing products and services that are accessible for people with disabilities. This commitment supports the company's diversity objectives and helps ensure that the benefits of technology are available to all.

The HP accessibility goal is to design, produce, and market products and services that can be effectively used by everyone, including people with disabilities, either on a standalone basis or with appropriate assistive devices.

To achieve that goal, this Accessibility Policy establishes seven key objectives to guide HP actions. All HP managers and employees are expected to support these objectives and their implementation in accordance with their roles and responsibilities:

- Raise the level of awareness of accessibility issues within HP, and provide employees with the training they need to design, produce, market, and deliver accessible products and services.
- Develop accessibility guidelines for products and services, and hold product development groups accountable for implementing these guidelines where competitively, technically, and economically feasible.
- Involve people with disabilities in the development of accessibility guidelines and in the design and testing of products and services.
- Document accessibility features, and make information about HP products and services publicly available in an accessible form.
- Establish relationships with leading assistive technology and solution providers.
- Support internal and external research and development that improves assistive technology relevant to HP products and services.

- Support and contribute to industry standards and guidelines for accessibility.

## International Association of Accessibility Professionals (IAAP)

IAAP is a not-for-profit association focused on advancing the accessibility profession through networking, education, and certification. The objective is to help accessibility professionals develop and advance their careers and to better enable organizations to integrate accessibility into their products and infrastructure.

As a founding member, HP joined to participate with other organizations to advance the field of accessibility. This commitment supports HP's accessibility goal of designing, producing, and marketing products and services that people with disabilities can effectively use.

IAAP will make the profession strong by globally connecting individuals, students, and organizations to learn from one another. If you are interested in learning more, go to <http://www.accessibilityassociation.org> to join the online community, sign up for newsletters, and learn about membership options.

## Finding the best assistive technology

Everyone, including people with disabilities or age-related limitations, should be able to communicate, express themselves, and connect with the world using technology. HP is committed to increasing accessibility awareness within HP and with our customers and partners.

Whether it's large fonts that are easy on the eyes, voice recognition that lets you give your hands a rest, or any other assistive technology to help with your specific situation—a variety of assistive technologies make HP products easier to use. How do you choose?

## Assessing your needs

Technology can unleash your potential. Assistive technology removes barriers and helps you create independence at home, at work, and in the community. Assistive technology (AT) helps increase, maintain, and improve the functional capabilities of electronic and information technology.

You can choose from many AT products. Your AT assessment should allow you to evaluate several products, answer your questions, and facilitate your selection of the best solution for your situation. You will find that professionals qualified to do AT assessments come from many fields, including those licensed or certified in physical therapy, occupational therapy, speech/language pathology, and other areas of expertise. Others, while not certified or licensed, can also provide evaluation information. You will want to ask about the individual's experience, expertise, and fees to determine if they are appropriate for your needs.

## Accessibility for HP products

These links provide information about accessibility features and assistive technology, if applicable and available in your country or region, that are included in various HP products. These resources will help you select the specific assistive technology features and products most appropriate for your situation.

- HP Aging & Accessibility: Go to <http://www.hp.com>, type `Accessibility` in the search box. Select **Office of Aging and Accessibility**.
- HP computers: For Windows products, go to <http://www.hp.com/support>, type `Windows Accessibility Options` in the **Search our knowledge library** search box. Select the appropriate operating system in the results.
- HP Shopping, peripherals for HP products: Go to <http://store.hp.com>, select **Shop**, and then select **Monitors or Accessories**.

If you need additional support with the accessibility features on your HP product, see [Contacting support on page 28](#).

Additional links to external partners and suppliers that may provide additional assistance:

- [Microsoft Accessibility information \(Windows and Microsoft Office\)](#)
- [Google Products accessibility information \(Android, Chrome, Google Apps\)](#)

## Standards and legislation

Countries worldwide are enacting regulations to improve access to products and services for persons with disabilities. These regulations are historically applicable to telecommunications products and services, PCs and printers with certain communications and video playback features, their associated user documentation, and their customer support.

### Standards

The US Access Board created Section 508 of the Federal Acquisition Regulation (FAR) standards to address access to information and communication technology (ICT) for people with physical, sensory, or cognitive disabilities.

The standards contain technical criteria specific to various types of technologies, as well as performance-based requirements which focus on functional capabilities of covered products. Specific criteria cover software applications and operating systems, web-based information and applications, computers, telecommunications products, video and multimedia, and self-contained closed products.

### Mandate 376 – EN 301 549

The European Union created the EN 301 549 standard within Mandate 376 as an online toolkit for public procurement of ICT products. The standard specifies the accessibility requirements applicable to ICT products and services, with a description of the test procedures and evaluation methodology for each requirement.

### Web Content Accessibility Guidelines (WCAG)

Web Content Accessibility Guidelines (WCAG) from the W3C's Web Accessibility Initiative (WAI) helps web designers and developers create sites that better meet the needs of people with disabilities or age-related limitations.

WCAG advances accessibility across the full range of web content (text, images, audio, and video) and web applications. WCAG can be precisely tested, is easy to understand and use, and allows web developers flexibility for innovation. WCAG 2.0 has also been approved as [ISO/IEC 40500:2012](#).

WCAG specifically addresses barriers to accessing the web experienced by people with visual, auditory, physical, cognitive, and neurological disabilities, and by older web users with accessibility needs. WCAG 2.0 provides characteristics of accessible content:

- **Perceivable** (for instance, by addressing text alternatives for images, captions for audio, adaptability of presentation, and color contrast)
- **Operable** (by addressing keyboard access, color contrast, timing of input, seizure avoidance, and navigability)
- **Understandable** (by addressing readability, predictability, and input assistance)
- **Robust** (for instance, by addressing compatibility with assistive technologies)

## Legislation and regulations

Accessibility of IT and information has become an area of increasing legislative importance.

The [HP policy landscape](#) website provides information about key legislation, regulations, and standards in the following locations:

- United States
- Canada
- Europe
- Australia

## Useful accessibility resources and links

These organizations, institutions, and resources might be good sources of information about disabilities and age-related limitations.



---

**NOTE:** This is not an exhaustive list. These organizations are provided for informational purposes only. HP assumes no responsibility for information or contacts you encounter on the internet. Listing on this page does not imply endorsement by HP.

---

## Organizations

These organizations are a few of the many that provide information about disabilities and age-related limitations.

- American Association of People with Disabilities (AAPD)
- The Association of Assistive Technology Act Programs (ATAP)
- Hearing Loss Association of America (HLAA)
- Information Technology Technical Assistance and Training Center (ITTATC)
- Lighthouse International
- National Association of the Deaf
- National Federation of the Blind
- Rehabilitation Engineering & Assistive Technology Society of North America (RESNA)
- Telecommunications for the Deaf and Hard of Hearing, Inc. (TDI)
- W3C Web Accessibility Initiative (WAI)

## Educational institutions

Many educational institutions, including these examples, provide information about disabilities and age-related limitations.

- California State University, Northridge, Center on Disabilities (CSUN)
- University of Wisconsin - Madison, Trace Center



- University of Minnesota computer accommodations program

## Other disability resources

Many resources, including these examples, provide information about disabilities and age-related limitations.

- ADA (Americans with Disabilities Act) Technical Assistance Program
- ILO Global Business and Disability network
- EnableMart
- European Disability Forum
- Job Accommodation Network
- Microsoft Enable

## HP links

These HP-specific links provide information that relates to disabilities and age-related limitations.

[HP comfort and safety guide](#)

[HP public sector sales](#)

## Contacting support

HP offers technical support and assistance with accessibility options for customers with disabilities.



---

**NOTE:** Support is in English only.

---

- Customers who are deaf or hard of hearing who have questions about technical support or accessibility of HP products:
  - Use TRS/VRS/WebCapTel to call (877) 656-7058 Monday through Friday, 6 a.m. to 9 p.m. Mountain Time.
- Customers with other disabilities or age-related limitations who have questions about technical support or accessibility of HP products:
  - Call (888) 259-5707 Monday through Friday, 6 a.m. to 9 p.m. Mountain Time.

# Index

## A

- AC adapter light 3
- accessibility 24, 25, 27, 28
- accessibility needs
  - assessment 25
- action keys 6
  - back 7
  - brightness down 7
  - brightness up 7
  - display apps 7
  - full screen 7
  - identifying 5
  - keyboard backlight 7
  - menu 7
  - mute 7
  - mute mic on 7
  - play/pause 7
  - reload 7
  - screenshot 7
  - volume down 7
  - volume up 7
- action keys keyboard backlight 7
- assistive technology (AT)
  - finding 25
  - purpose 24
- AT (assistive technology)
  - finding 25
  - purpose 24
- audio-in (microphone) jack,
  - identifying 3
- audio-out (headphone) jack,
  - identifying 3

## B

- back action key 7
- backing up 15
- battery
  - charging 13
  - factory sealed 13
  - light 3
- Bluetooth label 8
- brightness down action key 7
- brightness up action key 7

## C

- camera 4
  - identifying 4

- camera light, identifying 4
- camera privacy cover,
  - identifying 4
- Chromebook Recovery Utility,
  - installing 16
- components
  - bottom 7
  - display 3
  - keyboard area 4
  - left side 2
  - right side 2
- customer support,
  - accessibility 28

## D

- display apps window action key 7

## E

- electrostatic discharge 23
- esc key, identifying 5

## F

- full screen action key 7

## H

- headphone (audio-out) jack 3
- HP Assistive Policy 24
- HPSA, identifying 19

## I

- input power 20
- internal microphones,
  - identifying 4
- International Association of Accessibility Professionals 25

## J

- jacks
  - audio-in (microphone) 3
  - audio-out (headphone) 3

## K

- keys
  - esc 5

## L

- labels
  - Bluetooth 8
  - regulatory 8
  - serial number 8
  - service 8
  - wireless certification 8
  - WLAN 8
- lights
  - AC adapter and battery 3
  - camera 4

## M

- menu action key 7
- microphone (audio-in) jack,
  - identifying 3
- mute action key 7
- mute mic on key 7

## O

- operating environment 21

## P

- play/pause action key 7
- ports
  - USB 2
  - USB SuperSpeed charging 2
  - USB Type-C 2, 3
  - USB Type-C port, identifying 2
- printing 14
- product name and number,
  - computer 8

## R

- recovery media
  - creating 16
  - erase 17
- recovery, performing 15
- regulatory information
  - regulatory label 8
  - wireless certification labels 8
- reload action key 7
- resetting 15
- resources, accessibility 27

## S

- screenshot action key 7
- scrolling touch screen gesture 11
- scrolling touchpad gesture 10
- Section 508 accessibility standards 26
- serial number, computer 8
- service labels, locating 8
- speakers, identifying 5
- specifications 20
- standards and legislation, accessibility 26
- support 19
- swiping touch screen gesture 11
- system recovery
  - Chrome operating system 17
  - Chromebook Recovery Utility 16
  - internet connection 16
  - recovery media 16

## T

- tap gestures 10
- touch screen gestures
  - one-finger scrolling 11
  - one-finger swipe 11
  - two-finger pinch zoom 12
- Touchpad and touch screen gestures, tap 10
- touchpad gestures, scrolling 10
- touchpad zone, identifying 4
- traveling with the computer 8
- two-finger pinch zoom touch screen gesture 12

## U

- USB port, identifying 2
- USB Type-C port, identifying 3

## V

- vent, identifying 8
- volume down action key 7
- volume up action key 7

## W

- wireless certification label 8
- WLAN antennas, identifying 4
- WLAN device 8
- WLAN label 8