

# ***Shark***

## **Corded Upright Vacuum with Lift-Away™ Technology**

NV602UK Series

### **INSTRUCTIONS**

---



# THANK YOU

for purchasing the Shark® Corded Upright Vacuum with Lift-Away™ Technology.



**TIP:** You can find the model and serial numbers on the QR code label located on the back of your unit.

**TIP:** You can locate the date code on one of the prongs of the power cord plug.

## REGISTER YOUR PURCHASE

### TO BENEFIT FROM YOUR PRODUCT'S EXTENDED GUARANTEE, SIMPLY REGISTER YOUR PURCHASE AT:

- [sharkclean.co.uk/register-guarantee](http://sharkclean.co.uk/register-guarantee)
- +44 (0)800 862 0453
- Scan QR code using mobile device

Please note, products purchased directly from Shark are automatically registered.

Benefits of registering your product and creating an account:

- Get easier, faster product support and access to guarantee information
- Access troubleshooting and product care instructions
- Be among the first to know about exclusive product promotions

## RECORD THIS INFORMATION

Model Number: \_\_\_\_\_

Serial Number \_\_\_\_\_

Date Code: \_\_\_\_\_

Date of Purchase (Keep receipt): \_\_\_\_\_

Store of Purchase: \_\_\_\_\_

## TECHNICAL SPECIFICATIONS

Voltage: 220-240V~, 50-60Hz

Body Motor Watts: 750W

Nozzle Watts: 80W

## PLEASE READ CAREFULLY AND KEEP FOR FUTURE REFERENCE.

This instruction manual is designed to help you get a complete understanding of your new Shark Corded Upright Vacuum with Lift-Away™ Technology.

If you have any questions, please call the customer service line on +44 (0)800 862 0453.



# CONTENTS

<b>Important Safety Instructions</b> .....	<b>4</b>
<b>Getting to Know Your Shark® Lift-Away™</b> .....	<b>6</b>
<b>Assembly</b> .....	<b>8</b>
Power Cord .....	9
<b>Settings</b> .....	<b>10</b>
Brush-Roll Indicator Light.....	10
<b>Cleaning Modes</b> .....	<b>11</b>
<b>Emptying the Dust Cup</b> .....	<b>12</b>
<b>Cleaning the Filters</b> .....	<b>13</b>
Cleaning the Brush Roll.....	13
<b>Checking for Blockages</b> .....	<b>14</b>
<b>Available accessories</b> .....	<b>15</b>
<b>Troubleshooting Guide</b> .....	<b>16</b>
<b>Guarantee Terms and Conditions</b> .....	<b>17</b>



This marking indicates that this product should not be disposed with other household wastes throughout the EU. To prevent possible harm to the environment or human health from uncontrolled waste disposal, recycle it responsibly to promote the sustainable reuse of material sources. To return your used device, please use the return and collection systems or contact the retailer where this product was purchased. They can take this product for environmental safe recycling.

# IMPORTANT SAFETY INSTRUCTIONS

FOR HOUSEHOLD USE ONLY • PLEASE READ ALL INSTRUCTIONS BEFORE USING THIS VACUUM.

IF YOU HAVE DELICATE OR WOOL CARPETS, PARTICULARLY LOOP PILE, PLEASE TRY THE VACUUM ON A HIDDEN AREA FIRST TO ENSURE THE SPINNING BRUSH-ROLLS DO NOT DAMAGE OR UNPICK CARPET FIBRES.

## ⚠ WARNING

REDUCE THE RISK OF FIRE, ELECTRIC SHOCK, INJURY, OR PROPERTY DAMAGE:

### GENERAL WARNINGS

- 1 Your vacuum cleaner may consist of a motorised nozzle, wand, hose, and/or vacuum pod. This device contains electrical connections, electrical wiring, and moving parts that potentially present risk to the user.
- 2 Use only identical replacement parts.
- 3 Carefully observe and follow the instructions provided below to avoid improper use of the appliance. **DO NOT** use the vacuum for any purpose other than those described in this manual.
- 4 Before use, carefully inspect all parts for any damage. **DO NOT** use if any parts are damaged.
- 5 The use of an extension cord is **NOT** recommended.
- 6 **CAUTION:** This vacuum cleaner handle contains electrical connections. This vacuum contains no serviceable parts.

### USE WARNINGS

- 7 This appliance can be used by persons with reduced physical, sensory or mental capabilities or lack of experience and knowledge if they have been given supervision or instruction concerning use of the appliance in a safe way and understand the hazards involved.
- 8 **DO NOT allow the appliance to be used by children.** Keep the appliance and its cord out of reach of children. Do not allow to be used as a toy. Close supervision is necessary when used near children. Cleaning and user maintenance shall not be done by children.
- 9 Always turn off the vacuum cleaner before connecting or disconnecting any motorised nozzles or other accessories.

- 10 **DO NOT** handle plug or vacuum cleaner with wet hands.
- 11 **DO NOT** use without filters in place.
- 12 If you have delicate or wool carpets, particularly loop pile, turn the spinning brush-roll off by selecting the Hard Floor setting when cleaning these surfaces as the bristles have the potential to damage or unpick carpet fibres.
- 13 **DO NOT** damage the power cord:
  - a) **DO NOT** pull or carry vacuum cleaner by the cord or use the cord as a handle.
  - b) **DO NOT** unplug by pulling on cord. Grasp the plug, not the cord.
  - c) **DO NOT** run the vacuum cleaner over the power cord, close a door on the cord, pull the cord around sharp corners, or leave the cord near heated surfaces.
- 14 Only use Shark branded filters and accessories. Use of non-Shark parts may invalidate your guarantee.
- 15 **DO NOT** put any objects into nozzle or accessory openings. **DO NOT** use with any opening blocked; keep free of dust, lint, hair, and anything that may reduce airflow.
- 16 **DO NOT** use if nozzle or accessory airflow is restricted. If the air paths or the motorised floor nozzle become blocked, turn the vacuum cleaner off and unplug from electrical outlet. Remove all obstructions before you plug in and turn on the unit again.
- 17 Keep nozzle and all vacuum openings away from hair, face, fingers, uncovered feet, or loose clothing.
- 18 **DO NOT** use if vacuum cleaner is not working as it should, or has been dropped, damaged, left outdoors, or dropped into water.

# SAVE THESE INSTRUCTIONS

READ ALL INSTRUCTIONS BEFORE USE

- 19 If the supply cord is damaged, it must be replaced by the manufacturer, its service agent or similar qualified persons in order to avoid a hazard.
- 20 Use extra care when cleaning on stairs.
- 21 **DO NOT** leave the vacuum cleaner unattended while plugged in.
- 22 When powered on, keep the vacuum cleaner moving over the carpet surface at all times to avoid damaging the carpet fibres.
- 23 **DO NOT** place vacuum cleaner on unstable surfaces such as chairs or tables.
- 24 Your Shark® vacuum may not be designed to stand up on its own. When taking a break from cleaning, you may need to lean it against furniture or a wall, or lay it flat on the floor. Using the vacuum for an application where the unit lacks stability may result in personal injury.
- 25 **DO NOT** use to pick up:
  - a) Liquids
  - b) Large objects
  - c) Hard or sharp objects (glass, nails, screws, or coins)
  - d) Large quantities of dust (drywall dust, fireplace ash, or embers). **DO NOT** use as an attachment to power tools for dust collection.
  - e) Smoking or burning objects (hot coals, cigarette butts, or matches)
  - f) Flammable or combustible materials (lighter fluid, gasoline, or kerosene)
  - g) Toxic materials (chlorine bleach, ammonia, or drain cleaner)
- 26 **DO NOT** use in the following areas:
  - a) Poorly lit areas
  - b) Wet or damp surfaces
  - c) Outdoor areas
  - d) Spaces that are enclosed and may contain explosive or toxic fumes or vapors (lighter fluid, gasoline, kerosene, paint, paint thinners, mothproofing substances, or flammable dust)
- 27 Turn off all controls before plugging in or unplugging the vacuum.
- 28 Unplug from electrical outlet when not in use and before any maintenance or cleaning.
- 29 Hand wash with water only. Washing with cleaning chemicals could damage the unit.
- 30 During cleaning or routine maintenance, **DO NOT** cut anything other than hair, fibres, or string wrapped around the brush-roll.
- 31 Allow all filters to air-dry completely before replacing in the vacuum to prevent liquid from being drawn into electric parts.
- 32 Make sure the dust cup and all filters are in place after routine maintenance.
- 33 If provided, secure the power cord around the two cord hooks during storage.

# SAVE THESE INSTRUCTIONS

## GETTING TO KNOW YOUR SHARK® CORDED UPRIGHT VACUUM WITH LIFT-AWAY™ TECHNOLOGY.

### WELCOME!

Congratulations on your purchase. Use this instruction manual to learn about your new vacuum's great features. From assembly to use to maintenance, you will find it all in here.

#### MAIN UNIT

- A** Suction Control Slider
- B** Handle
- C** Hose
- D** Handle Release Button
- E** Power Switch
- F** Wand Release Button
- G** Wand
- H** Dust-Cup Release Latch
- I** Lift-Away™ Pod
- J** Dust-Cup Empty Buttons
- K** Lower Cord Hook
- L** Lift-Away™ Food Pedal
- M** Motorised Floor Nozzle
- N** Headlights
- O** Brush-roll indicator light

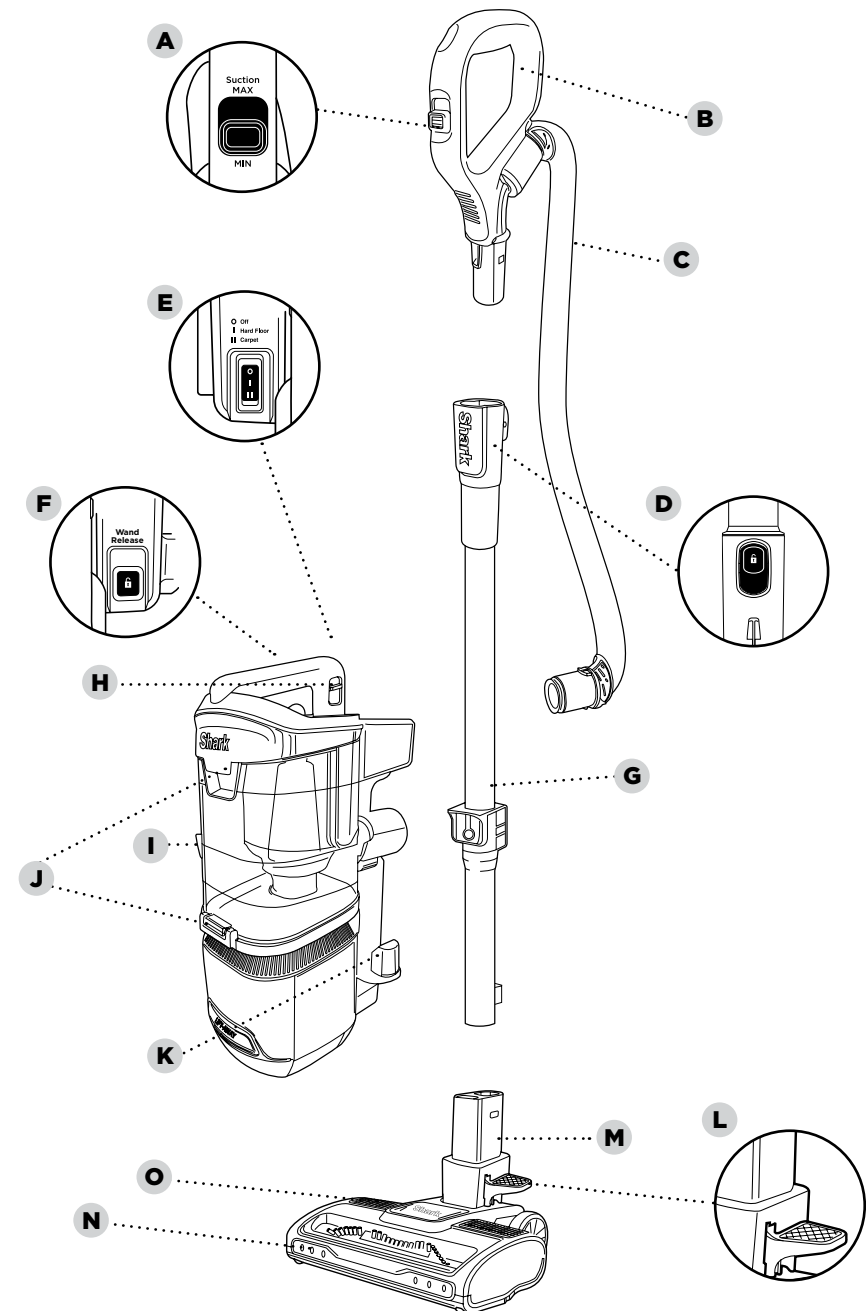

## ASSEMBLY

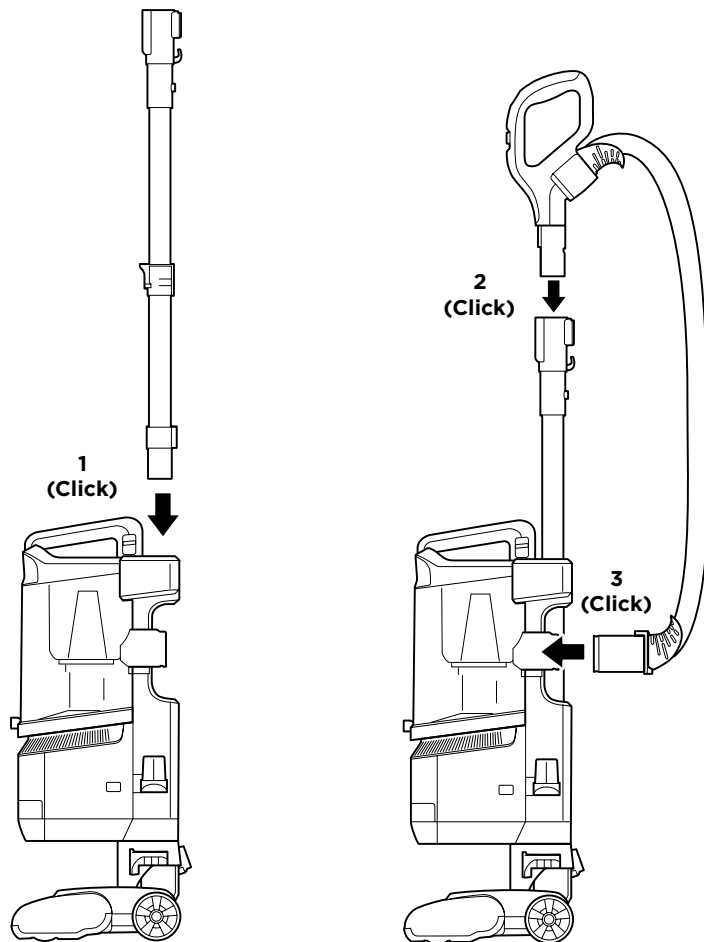

1. Insert **Wand** into pod
2. Insert **Handle** into wand.
3. Attach **Hose** to back of vacuum pod.

**NOTE:** Ensure all parts firmly **CLICK** into place before operating.

## ASSEMBLY

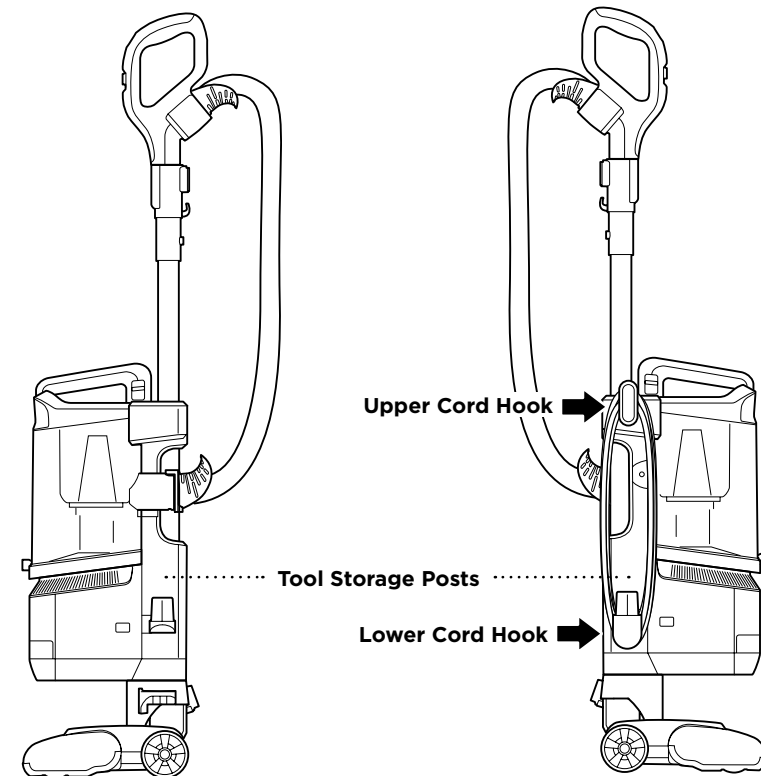

## POWER CORD

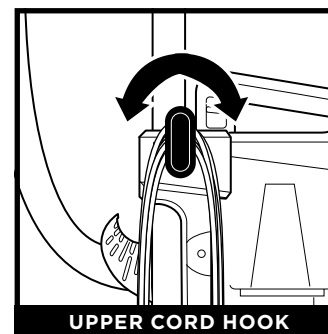

**UPPER CORD HOOK**  
For cord access, rotate upper hook down and remove cord.

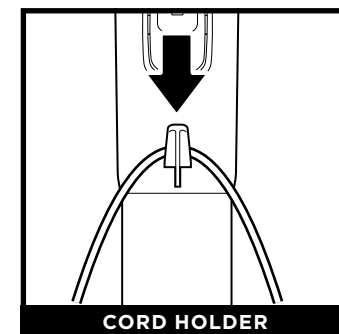

**CORD HOLDER**  
Use cord holder on the side of wand to hold cord in place while vacuuming.

## SETTINGS

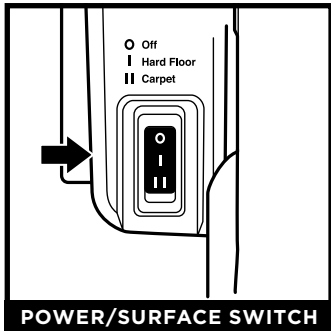

**POWER/SURFACE SWITCH**

Select surface setting:

**Off**

**I Hard Floor**

For hard floors, small area rugs or delicate carpets - the brush-roll will not spin in this mode.

**II Carpet**

For carpets.

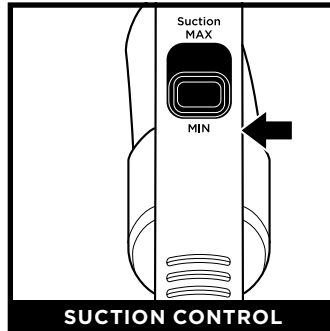

**SUCTION CONTROL**

The **Suction Control Slider** located on the handle allows you to adjust the suction depending on the floor type.

**MIN:** to reduce suction and increase maneuverability on carpets.

**MAX:** to increase suction on hard floors.

## BRUSH-ROLL INDICATOR LIGHT

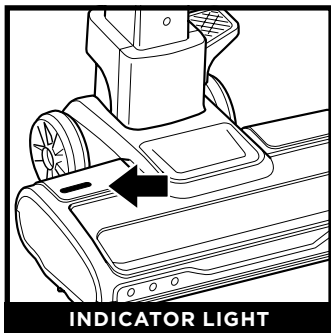

**INDICATOR LIGHT**

**WHAT DOES THE BRUSH-ROLL INDICATOR LIGHT MEAN?**

**Solid Green:** The brush-roll is spinning and working as intended.

**Solid Red:** There is a jam in the brush-roll area. Turn off and unplug the vacuum and remove any blockages in the nozzle.

**Flashing Red:** The motorised floor nozzle is overheating. Turn the vacuum off and wait a minimum of 60 minutes for the unit to cool down.

## CLEANING MODES

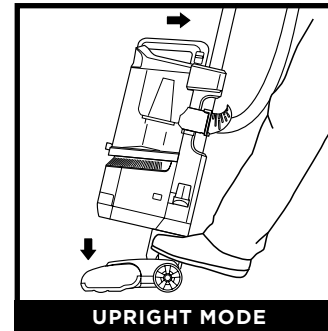

**UPRIGHT MODE**

To engage **brush-roll**, step on floor nozzle and tilt handle back firmly.

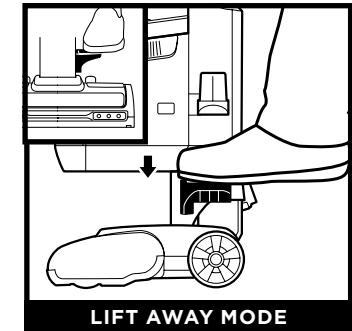

**LIFT AWAY MODE**

Step on the pedal on the floor nozzle to lift off the pod.

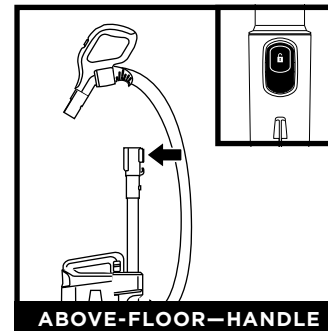

**ABOVE-FLOOR—HANDLE**

Press the **Handle Release** button and pull up on the handle to detach it from the wand.

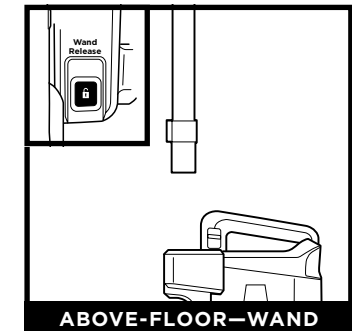

**ABOVE-FLOOR—WAND**

Press the **Wand Release** button and pull up on the wand to detach it from the pod.



**ACCESSORIES—HANDLE**

Attach an optional cleaning accessory to handle or wand.

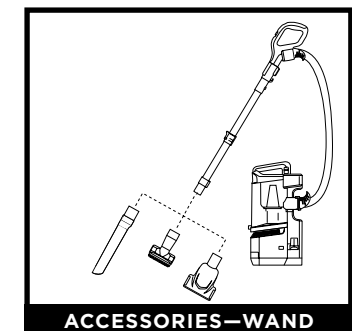

**ACCESSORIES—WAND**

**NOTE:** All accessories are compatible with both the wand and the handle. Included accessories will vary by model.

## EMPTYING THE DUST CUP

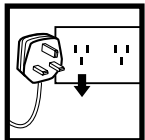

**IMPORTANT:** Unplug the power cord before performing any maintenance.

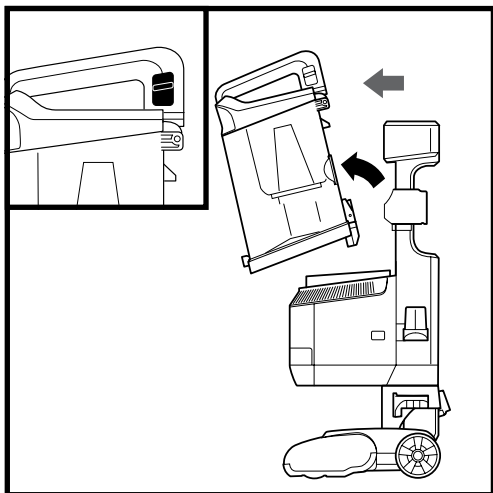

To remove **Dust Cup**, pull up on the release button located on the side of dust cup handle. Tilt dust cup forward, then lift to remove.

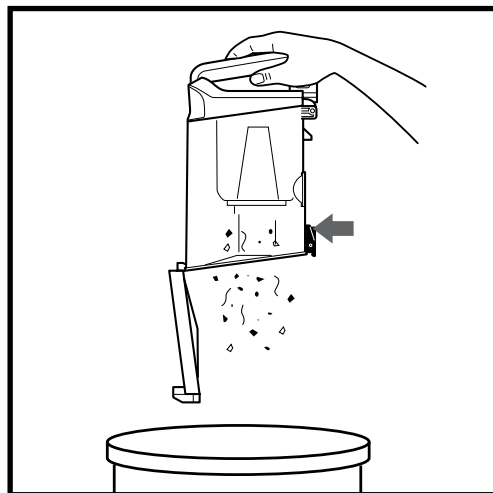

Hold the dust cup over the bin and press the release button to open bottom of dust cup.

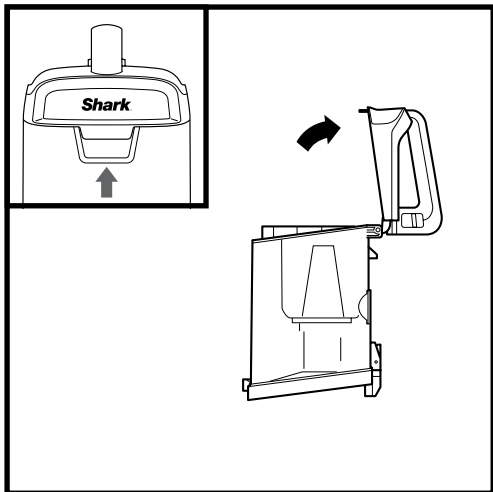

To remove collected debris from **Lint Screen**, lift the tab at the top of the dust cup to open the lid. Remove debris from lint screen to clean.

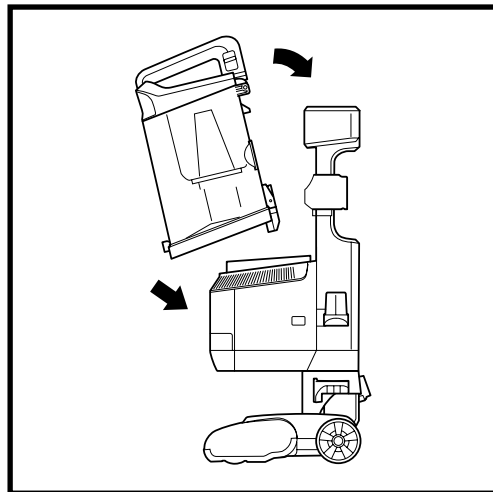

To reattach, place the bottom of dust cup onto the pod and then tilt until it clicks into place.

## CLEANING THE FILTERS

**Regularly rinse the filters to maintain your vacuum's suction power.**

Rinse filters with cold water only. Allow all filters to air-dry for at least 24 hours before reinstalling them to prevent liquid from being drawn into electronic parts.

**IMPORTANT: DO NOT** use soap when cleaning the filters.

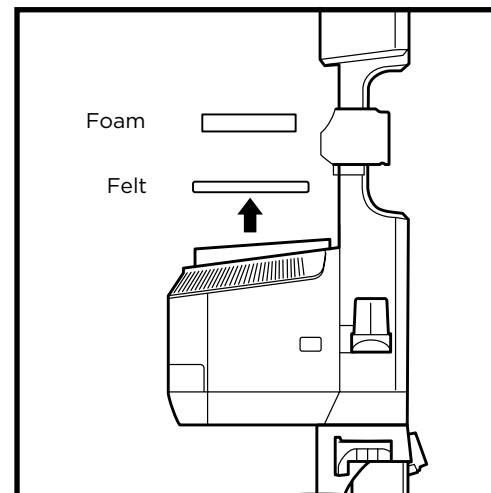

RINSE PRE-MOTOR FILTERS EVERY MONTH

### 1 Pre-Motor (foam and felt):

With the dust cup removed, take out the foam and felt filters, and rinse with water. Tap loose dirt off filters between washes as needed.

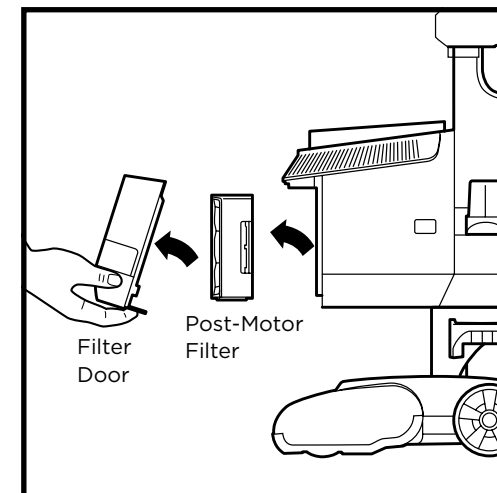

RINSE POST MOTOR FILTER EVERY YEAR

To remove the **Post motor Filter**, first pull the tab on the bottom of the filter door, then lift off the door. Press the tab on the side of the Post motor filter.

To reattach the door, align the top first, then press in the bottom until it clicks into place.

## CLEANING THE BRUSH-ROLL

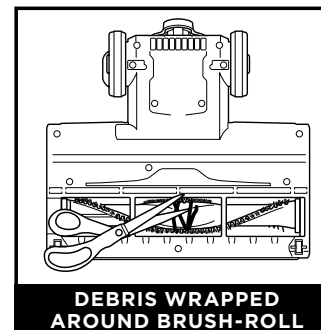

DEBRIS WRAPPED AROUND BRUSH-ROLL

Clean off any debris on the bristles. Carefully use scissors within the brush-roll groove to cut away any hair or debris wrapped around the brush-roll.

## MAINTENANCE

### CHECKING FOR BLOCKAGES

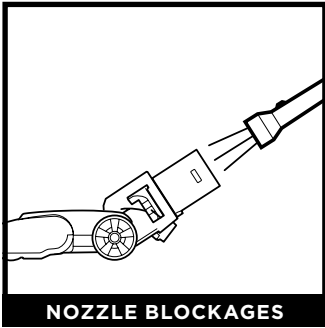

Check the opening at the top of the nozzle for any blockages.

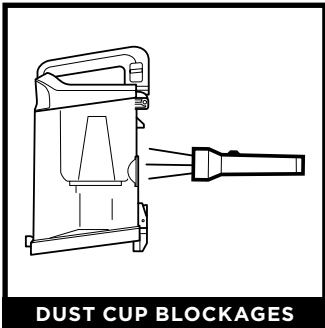

Detach dust cup from vacuum pod. Empty dust cup, remove debris from lint screen, and check for blockages.

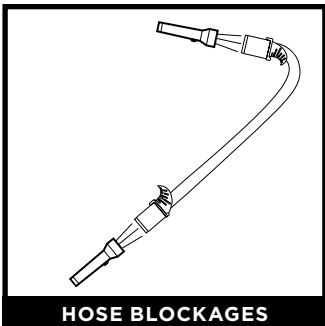

Detach hose from handle by pressing on the release button at the top of the hose. Detach the hose from the pod, and check openings for blockages.

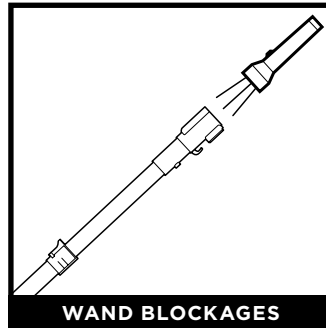

Detach wand from pod and handle, and check both ends for blockages.

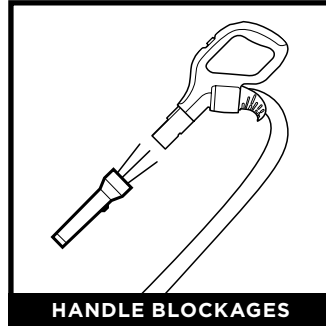

Detach handle from wand and check openings for blockages.

**NOTE:** Torch not included.

## AVAILABLE ACCESSORIES

**A Crevice Tool**  
Clean tight spaces, reach skirting boards and ceilings with this slim crevice tool.

**B Upholstery Tool**  
Remove pet hair and dust from curtains and other delicate fabrics and upholstery.

**C Dusting Brush**  
Dusts and cleans a multitude of delicate surfaces.

**D 2 in 1 Duster Crevice Tool**  
Two cleaning tools in one—the crevice tool gives you extended cleaning reach for small spaces, while the soft dusting brush cleans a multitude of surfaces.

**E Pet Power Brush**  
Picks up pet hair and loose debris, and powerfully deep cleans dander out of upholstery and other surfaces.

**F Multi Surface Tool**  
A single convertible tool for cleaning tough pet messes two ways: use the stiff bristle brush to clean stuck-on debris, or take off the bristles to reveal an upholstery tool perfect for removing stubborn pet hair and large piles of debris.

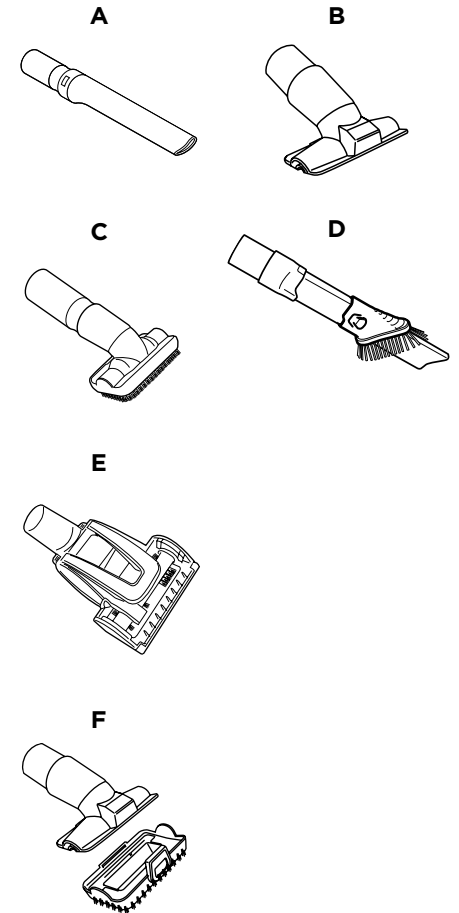

**NOTE:** Not all accessories come with all units. Please refer to the **packaging panels** for your unit's configuration. To order additional accessories, visit [sharkclean.co.uk](http://sharkclean.co.uk).



**⚠ WARNING: To reduce the risk of shock and unintended operation, turn power off and unplug unit before servicing.**

### **Vacuum is not picking up debris. No suction or light suction.**

**(Refer to Maintenance section for more information.)**

- Check filters to see if they need cleaning. Follow instructions for rinsing and drying the filters before re-inserting back into the vacuum.
- Dust cup may be full; empty dust cup.
- Check hose, hose connections, nozzles, and accessories for blockages; clear blockages if required.
- Remove any string, carpet fibres or hair that may be wrapped around the brush-roll.

### **Vacuum lifts area rugs.**

- Turn off the unit to disengage the brush-roll and restart with the POWER button for suction only cleaning.
- Suction is powerful. Take care when vacuuming area rugs or rugs with delicately sewn edges.
- Turn off the unit and disengage the area rug from the brush-roll and restart the unit.

### **Brush-roll does not spin.**

- If brush roll indicator light on the floor nozzle turns red, the brush roll has stopped spinning. Immediately turn off and unplug vacuum, disconnect the nozzle and remove blockage before reconnecting and turning vacuum back on.
- Pull the handle toward you and release the floor nozzle to disengage the auto-off feature.
- Make sure that the carpet height selector is not on the HARD FLOOR setting.
- Immediately turn off and unplug vacuum, disconnect the nozzle and remove blockage before reconnecting and turning vacuum back on.

### **Vacuum turns off on its own or brush-roll Indicator Light flashes red.**

This vacuum cleaner is equipped with a motor protective thermostat. If for some reason your vacuum overheats, the thermostat will automatically turn the suction motor off. Should this occur, perform the following steps to restart the thermostat:

1. Turn the unit off.
2. Unplug the vacuum.
3. Empty the dust cup and clean filters (see page previous page)
4. Check for blockages in hose, accessories and inlet openings.
5. Allow the unit to cool for a minimum of 45 minutes.
6. Plug in the vacuum.
7. Restart the unit by turning the power on.

Note: If vacuum still does not start, visit [sharkclean.co.uk/customer-care](http://sharkclean.co.uk/customer-care) or contact customer service on: 0800 862 0453.

## **Shark NINJA GUARANTEE TERMS AND CONDITIONS**

When a consumer buys a product in the UK, they get the benefit of legal rights relating to the quality of the product (your "statutory rights"). You can enforce these rights against your retailer. However, at Shark we are so confident about the quality of our products that we give you an additional manufacturer's Guarantee of up to five years upon registration with Shark. Offer valid only in United Kingdom and Republic of Ireland. These terms and conditions relate to our manufacturer's Guarantee only - your statutory rights are unaffected. The conditions below describe the prerequisites and scope of our Guarantee. They do not affect your statutory rights or the obligations of your retailer and your contract with them.

### **Shark Guarantees**

A household appliance like a vacuum cleaner constitutes a sizeable investment. Your new machine needs to work properly for as long as possible. The guarantee it comes with is an important consideration - and reflects how much confidence the manufacturer has in its product and manufacturing quality.

Every Shark machine comes with a free parts and labour guarantee. Our customer service helpline (0800 862 0453) is open from 9.00am to 6.00pm Monday - Friday. It's free to call, and you'll be put straight through to a Shark representative. You'll also find online support at [sharkclean.co.uk](http://sharkclean.co.uk).

### **How do I register my extended Shark guarantee?**

You can register your guarantee online within 28 days of purchase. To save time, you'll need the following information about your machine:

- Date you purchased the machine (receipt or delivery note)
- To register online, please visit [sharkclean.co.uk/uk/register-guarantee](http://sharkclean.co.uk/uk/register-guarantee)
- Serial Number

### **IMPORTANT**

- Both the 12 months and the extended 4 years guarantee will only cover your product from the date of purchase.
- Please keep your receipt at all times. Should you need to use your extended guarantee we will need your receipt to verify the information you have supplied to us is correct. The inability to produce a valid receipt may invalidate your guarantee.

### **What are the benefits of registering my free Shark guarantee?**

When you register your guarantee we'll have your details to hand if we ever need to get in touch. You can also receive tips and advice on how to get the best out of your Shark vacuum and hear the latest news about new Shark technology and launches.

If you register your guarantee online, you'll get instant confirmation that we've received your details.

### **How long are new Shark machines guaranteed for?**

Our confidence in our design and quality control means that your new Shark vacuum cleaner is guaranteed for a total of five years. (12 months plus an extended Guarantee of 4 years).

### **What is covered by the free Shark guarantee?**

Repair or replacement of your Shark machine (at Shark's discretion), including all parts and labour. A Shark guarantee is in addition to your legal rights as a consumer.

### **What is not covered by the free Shark guarantee?**

- Blockages - For details of how to unblock your vacuum cleaner, please refer to the Operating Manual.
- Normal wear and tear such as brush bar, fuse, belt, batteries etc.
- Accidental damage, faults caused by negligent use or care, misuse, neglect, careless operation or handling of the vacuum cleaner which is not in accordance with the Shark Operating Manual supplied with your machine.
- Use of the vacuum cleaner for anything other than normal domestic household purposes.
- Use of parts not assembled or installed in accordance with the operating instructions.
- Use of parts and accessories which are not Shark Genuine Components.
- Faulty installation (except where installed by Shark).
- Repairs or alterations carried out by parties other than Shark or its agents.

### **What happens when my guarantee runs out?**

Shark does not design products to last for a limited time. We do appreciate that there may be a desire for our customers to want to repair their vacuum cleaners after the Guarantee has elapsed. In this case please contact our free phone customer service help line and ask about our out Guarantee program, on 0800 862 0453.

### **Where can I buy genuine Shark spares and accessories?**

Shark spares and accessories are developed by the same engineers who developed your Shark vacuum. You'll find a full range of Shark spares and replacement parts for all Shark machines at [sharkclean.co.uk/uk/parts](http://sharkclean.co.uk/uk/parts). Accessories are at [sharkclean.co.uk](http://sharkclean.co.uk).

Please remember that the use of non-Shark parts may invalidate your guarantee.





**Euro-Pro Europe Limited,  
3150 Century Way,  
Thorpe Park, Leeds,  
LS15 8ZB, UK  
0800 862 0453  
www.sharkclean.co.uk**

Illustrations may differ from actual product. We are constantly striving to improve our products, therefore the specifications contained herein are subject to change without notice.

SHARK is a registered trademark of SharkNinja Operating LLC.

LIFT-AWAY is a trademark of SharkNinja Operating LLC.

© 2020 SharkNinja Operating LLC  
NV602UKSeries\_66\_IB\_MP\_200527\_MV1  
PRINTED IN CHINA

 **@sharkcleaninguk**

 **@sharkcleanuk**

 **@sharkcleanuk**