

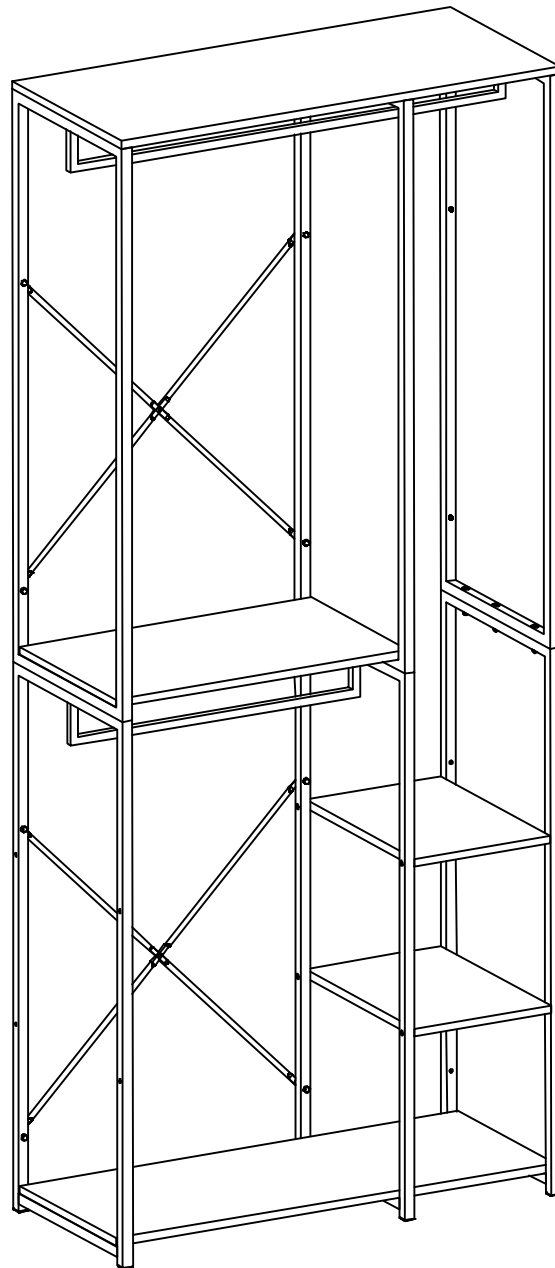

# DBL OPEN ROBE 3 RAILS 3 SHELVES



## Spare Parts

 [www.argos-support.co.uk](http://www.argos-support.co.uk)

 [Help@ClickSpares.co.uk](mailto:Help@ClickSpares.co.uk)

 0370 112 1928

## Customer Support

 0345 640 2020



# Safety and Care Advice

---

## Product Details

782/6342 DBL OPEN ROBE 3 RAILS 3 SHELVES

## Important, Retain For Future Reference: Read Carefully.

- Keep children and animals away from the work area, small parts could choke if swallowed.
- Assemble the item as close to its final position (in the same room) as possible.
- Assemble on a soft level surface to avoid damaging the unit or your floor.
- We do not recommend the use of power drill/drivers for inserting screws as this could damage the unit. Only use hand screwdrivers.
- Parts of the assembly will be easier with 2 people.
- Dispose of all packaging carefully and responsibly.

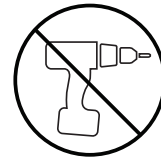

## Care and maintenance

---

- Only clean using a damp cloth and mild detergent. Do not use abrasive cleaners.
- From time to time check that there are no loose screws, nuts or bolts. If there are please re-tighten.
- This product should not be discarded with household waste. Take to your local authority waste disposal centre.
- Use a dry cloth to clean the product, furniture polish is not recommended.

## Additional Guidance

---

- Assemble all parts and bolts loosely during assembly, only once the product is complete should you fully tighten the bolts.
- Regularly check and ensure that all bolts and fittings are tightend properly.
- Maximum load weight 15kg.
- This product is compliant BS4875-7 & EN14749.

Sainsbury's Argos is a trading name of both: Argos Limited, Registered office: 489-499 Avebury Boulevard, Milton Keynes, United Kingdom, MK9 2NW, registered number: 01081551 (England and Wales); and Sainsbury's Supermarkets Limited, Registered office: 33 Holborn, London, EC1N 2HT, registered number: 03261722 (England and Wales). Both companies are subsidiaries of J Sainsbury's plc.

# Fittings (Shown to scale)

## Bag 1

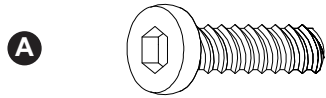

Bolt (M6x15mm) x 16

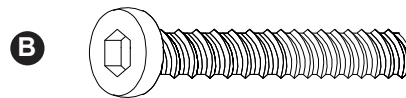

Bolt (M6x30mm) x 12

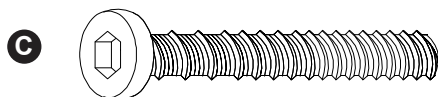

Bolt (M6x35mm) x 5

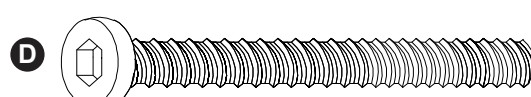

Bolt (M6x50mm) x 4

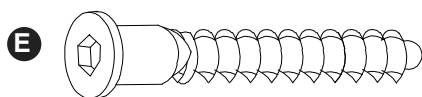

Screw(Ø7x38 mm) x 8

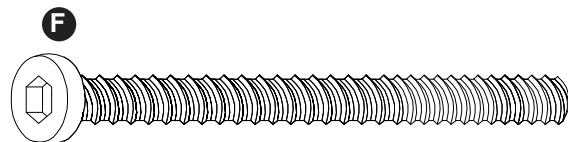

Bolt (M6x60mm) x 2

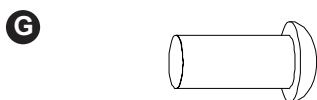

Nut (M6x14mm) x 19

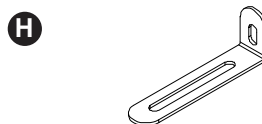

Wall Bracket x 2



Screw(Ø3.5x14mm) x 2

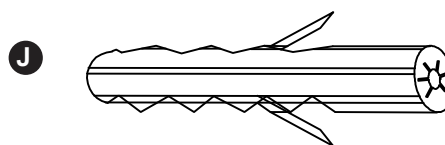

Wall Plug  
(Ø8x40 mm) x 2

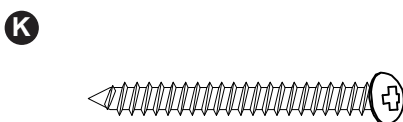

Screw(Ø4x35mm) x 2

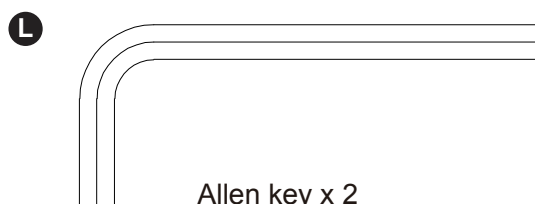

Allen key x 2

# Tools required

---

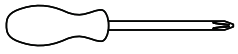

Phillips screwdriver  
(small & medium)

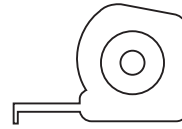

Ruler/tape  
measure

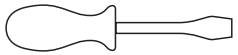

Phillips screwdriver  
(small & medium)

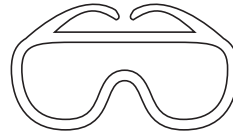

Eye protection  
(when using a  
hammer or glue)

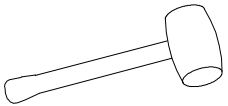

Rubber  
hammer

# Panels

---

- 1 Lower Section Side Bars x 3  
(1058 x 400 mm)

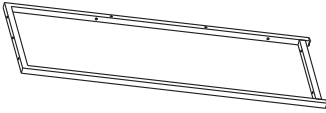

- 2 Upper Section Side Bars x 3  
(1058 x 400 mm)

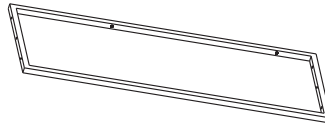

- 3 Top Panel x 1  
(900 x 400 mm)

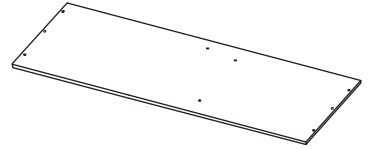

- 4 Base Panel x 1  
(900 x 358 mm)

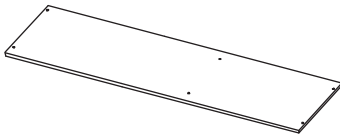

- 5 Middle Panel x 1  
(600 x 358 mm)

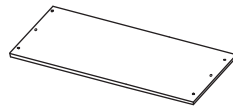

- 6 Small Shelf Panel x 2  
(400 x 280 mm)

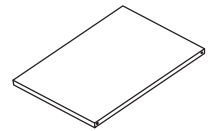

- 7 Cross Bars x 2  
(Ø6 x 855 mm)

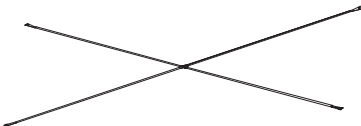

- 8 Short Hanging Rail x 1  
(598 x 100 mm)



- 9 Long Hanging Rail x 1  
(898 x 100 mm)

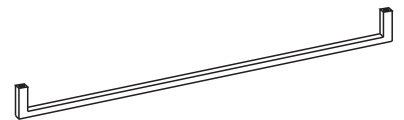

# 1

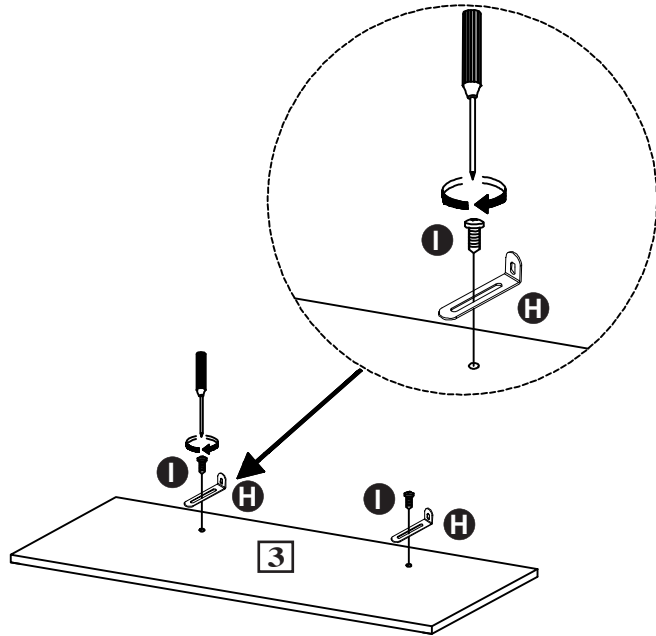
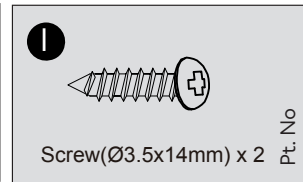
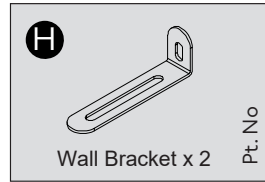
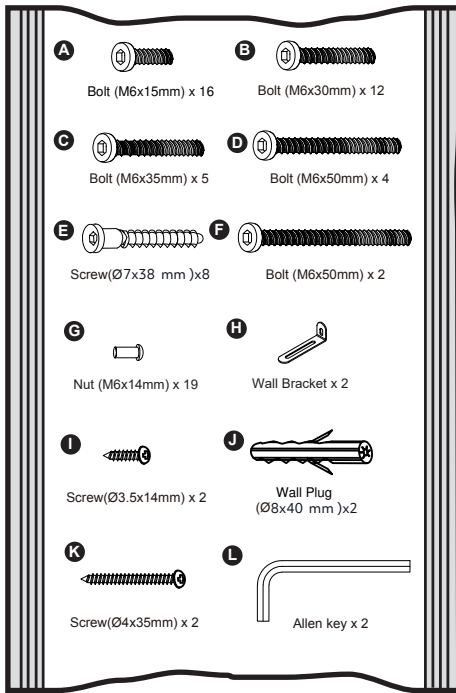

# 2

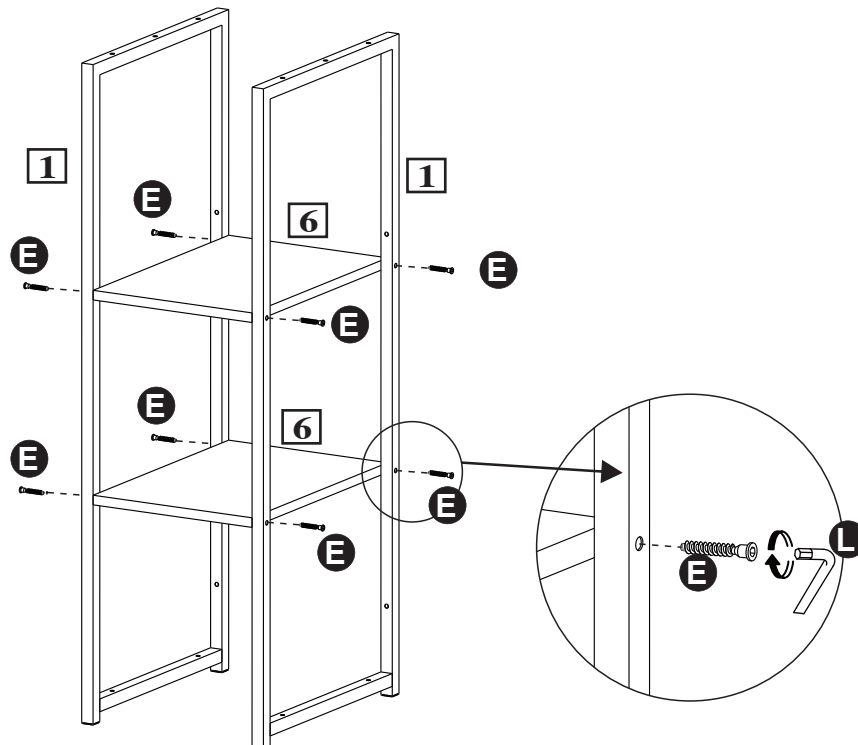
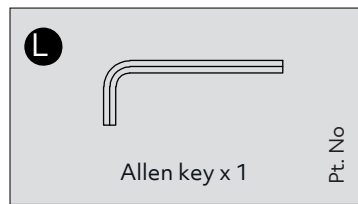
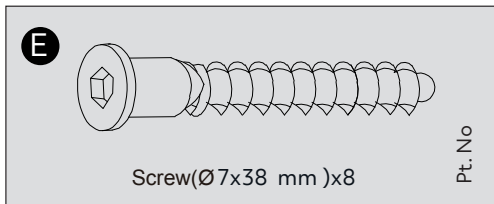

# 3

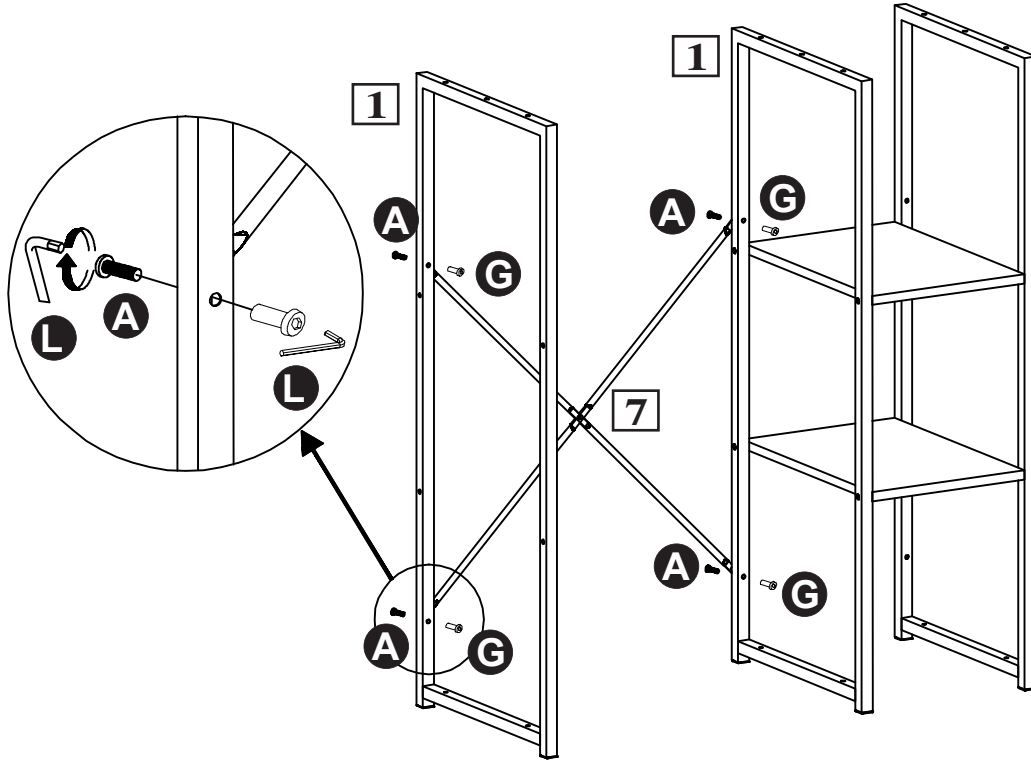
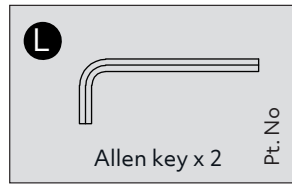
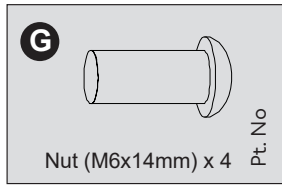
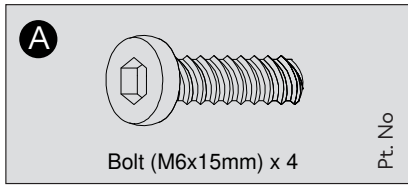

# 4

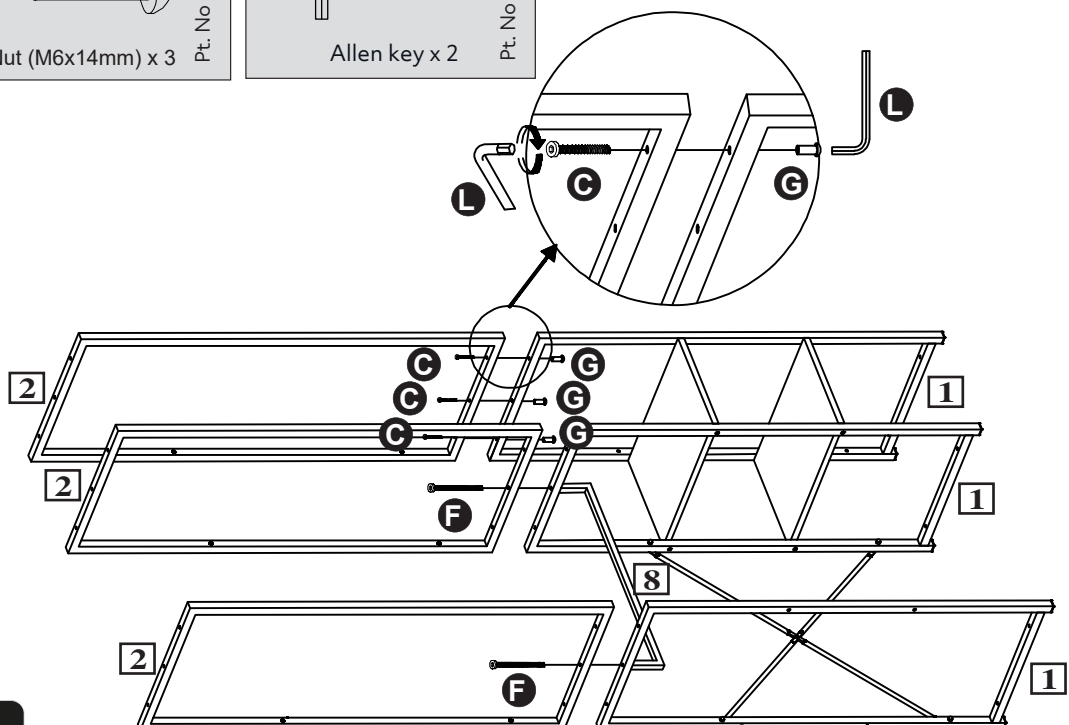
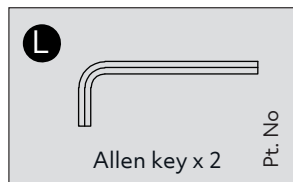
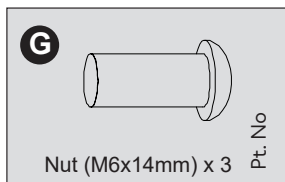
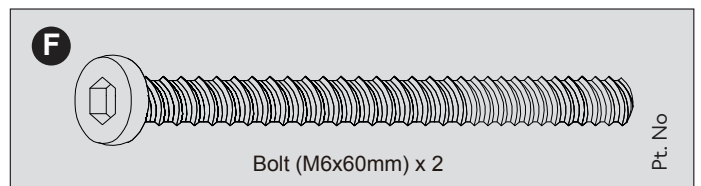
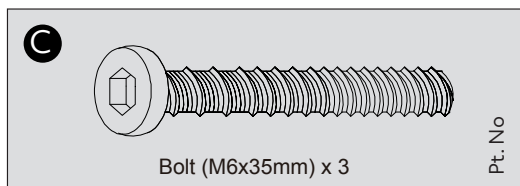

# 5

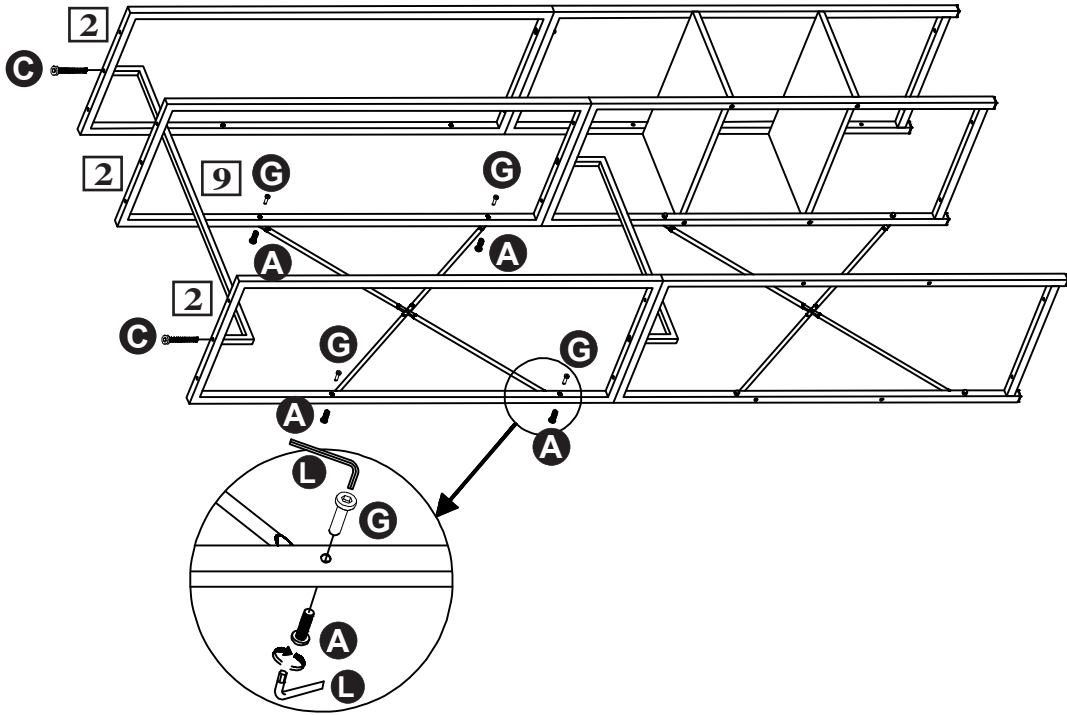
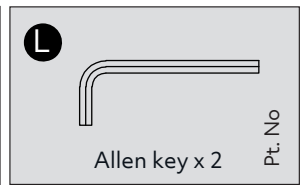
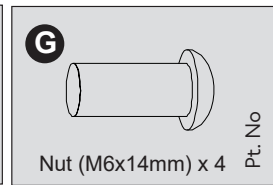
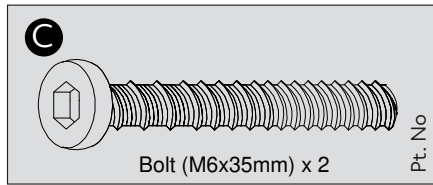
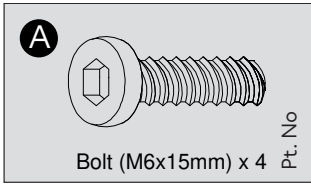

# 6

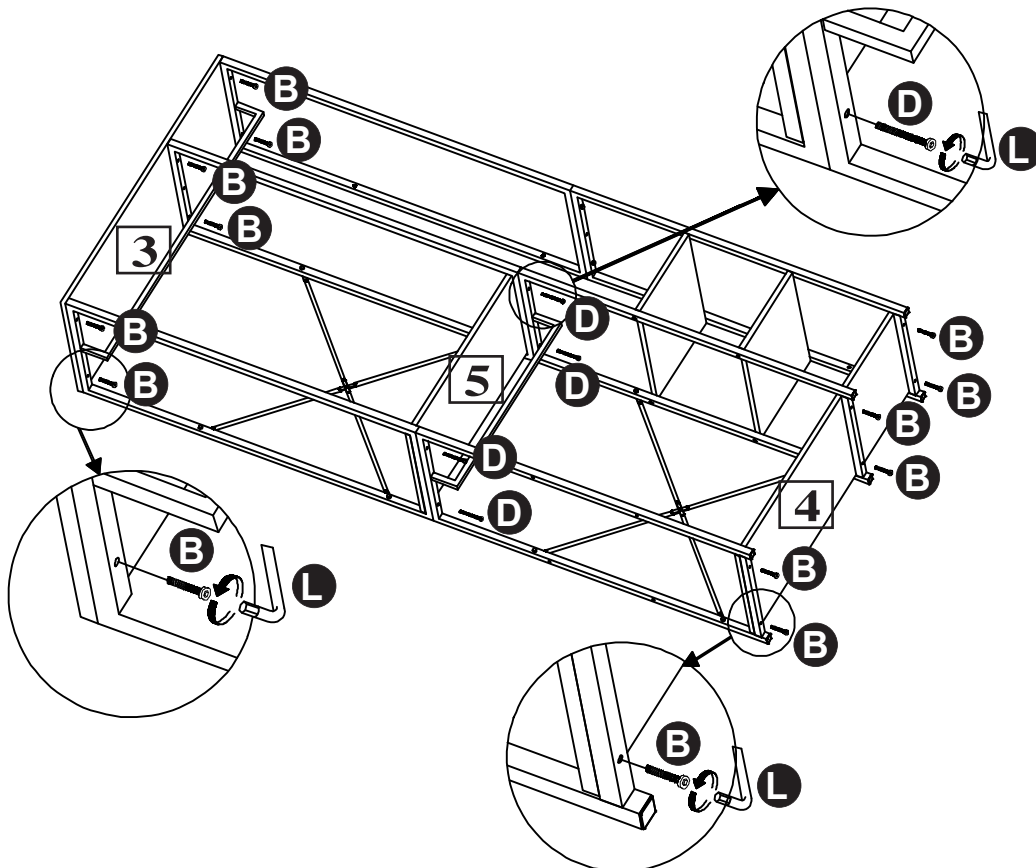
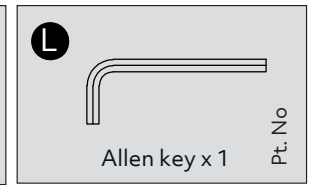
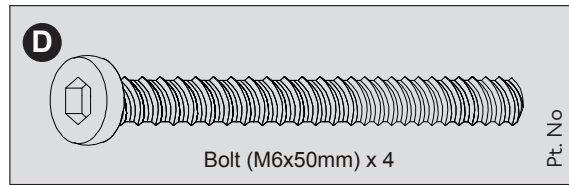
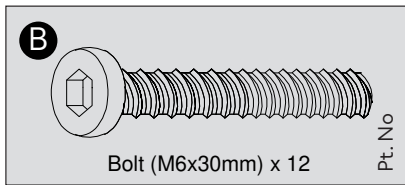



# 7

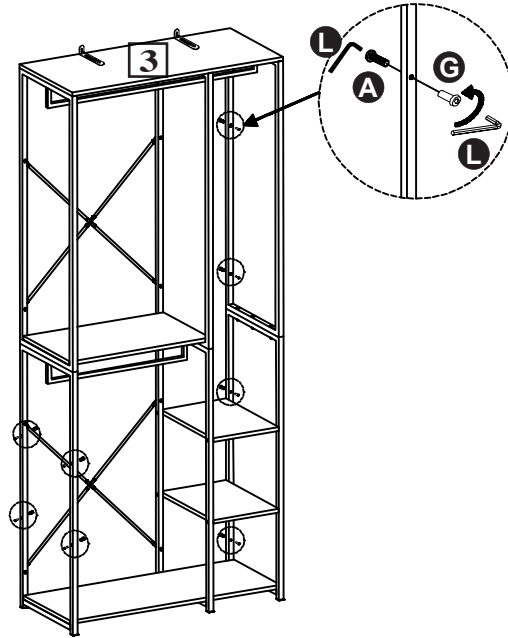
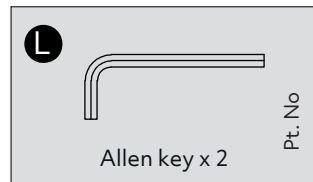
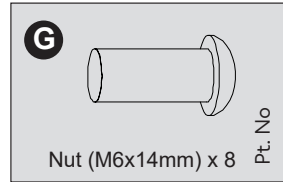
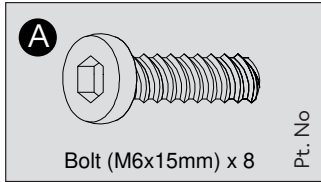

# 8

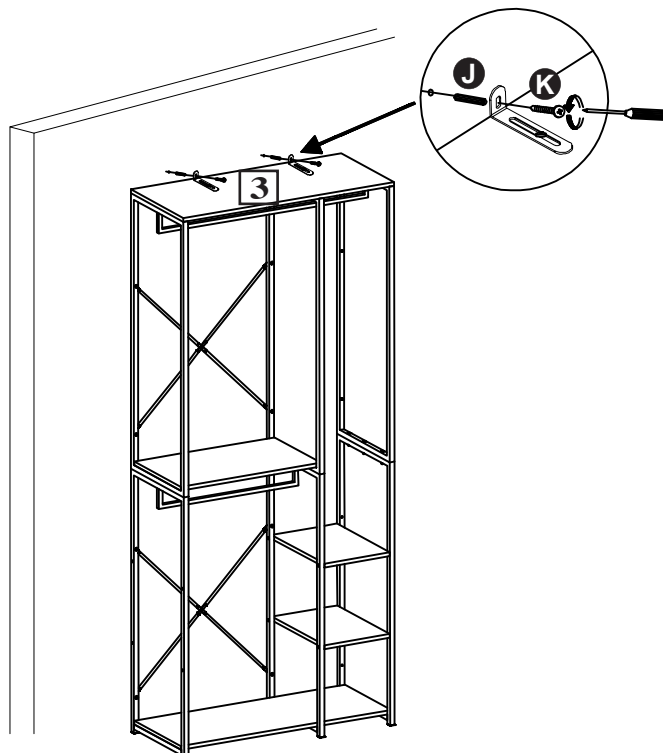
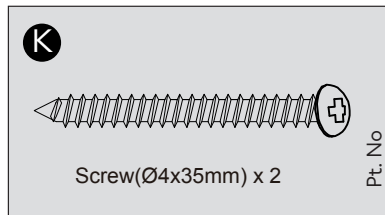
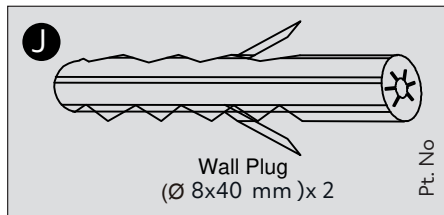

• **WARNING:** To prevent possible overbalancing this unit must be secured to a wall using the overbalance protector kit supplied.

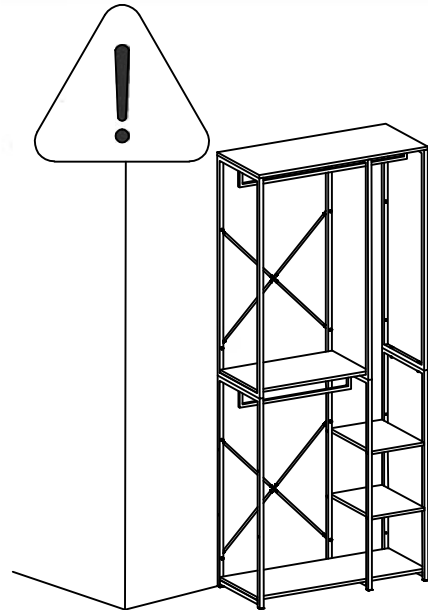

• A unit that is allowed to topple can cause serious or fatal injury. In addition to wall fixing the unit, place heavy items on the lower shelves, do not put any heavy objects on top of the unit and never allow children to climb or hang on drawers, doors or shelves.

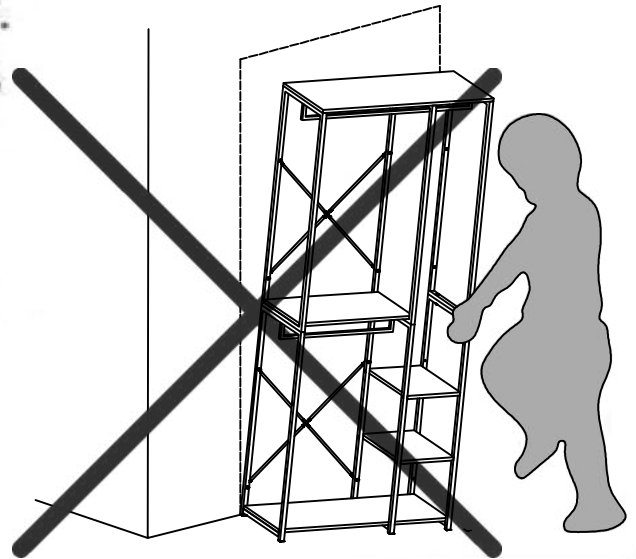

### **IMPORTANT**

**On a regular basis please check that the screws and fittings have not become loose as this could present a potential choke hazard.**

## **Assembly is complete**

# A Guide to - Wall Mounting & Fixings

## Important note:

If plastic wall plugs are supplied with your product:



- these are only suitable for use in masonry walls.

If you are in any doubt about the correct wall plugs for your wall, seek professional advice.

Failure of the product due to using incorrect fixings is the responsibility of the installer.



**Important:** When drilling into walls always check that there are no hidden wires or pipes etc.

Make sure that the screws and wall plugs being used are suitable for supporting your unit. Consult a qualified tradesperson if you are unsure.

### Hints:

- 1: **General rule:**  Always use a larger screw and wall plug if you are not sure.
- 2: Ensure you use the recommended drill bit to match the wall plug and hole size.
- 3: Ensure you drill the hole horizontally, do not force the drill or enlarge the hole.
- 4: Take extra care when drilling high walls, ceilings and ceramic tiles. Ensure wall plugs are inserted beyond the thickness of the ceramic tiles to avoid the tiles splitting or cracking.
- 5: Ensure wall plugs are well fitted and are a tight fit in the drilled hole.

## Types of walls

You can use one of the following types of wall plug if your walls are made of brick, breeze block, concrete, stone or wood.

### No.1 "General Purpose" wall plug

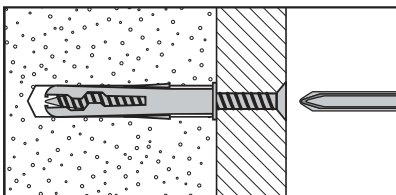

Generally aerated blocks should not be used to support heavy loads, use a specialist fitting in this case. For light loads, general purpose wall plugs can be used.

### No.2 "Plasterboard" wall plug

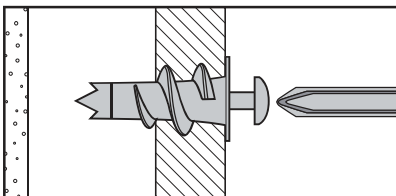

For use when attaching light loads on to plasterboard partitions.

### No.3 "Cavity Fixing" wall plug

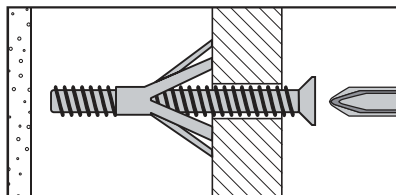

For use with plasterboard partitions or hollow wooden doors.

### No.4 "Cavity Fixing-Heavy Duty" wall plug

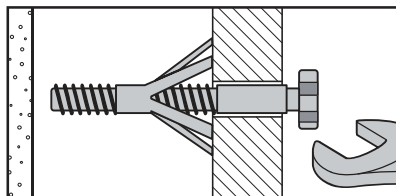

For use when fitting or supporting heavy loads such as shelving, wall cabinets and coat racks.

### No.5 "Hammer Fixing" wall plug

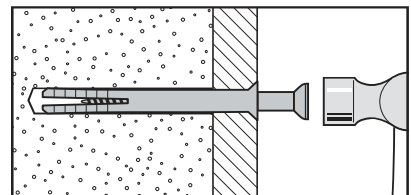

For use with walls stuck with plasterboard. The hammer fixing allows it to be fixed to the wall rather than the plasterboard. Always check the fixing is secure to the retaining wall.

### No.6 "Shield Anchor" wall plug Heavy loads

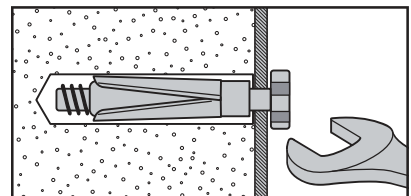

For use with heavier loads such as TV & HiFi speakers and satellite dishes etc.



## Care & Maintenance

**Safety:** Always check the fitting and location to ensure your safety in and around the home.

**Fitting:** From time to time check the fitting to ensure the wall plugs or screws do not become loose.