

Hisense

life reimagined

USER'S OPERATION MANUAL

Before operating this unit, please read this manual thoroughly, and retain for future reference.

WD5I1245B*R

WD5I1245B*R1

WD5I1245B*

EN

English

Thank you very much for choosing our product.

- Please install and operate this product correctly. Do not use it for any laundry labelled as not suitable for machine washing.
- The pictures shown in the manual are for illustrative purposes only. Appearance, printing and other details are subject to actual product.
- We prioritize technological innovation. To improve its overall performance, the appliance is subject to technical changes without notice.
- This product is intended solely for household use.

The following symbols used in this manual are defined below:

 Information, advice, tip, or recommendation

 WARNING - General Danger

 WARNING - Danger of Electric Shock

 WARNING - Danger of Hot Surface

 WARNING - Danger of Fire



Please read this manual thoroughly.

SAFETY PRECAUTIONS



Please read this manual carefully before operating the appliance.

Do not operate the appliance without understanding or reading this manual.

This manual applies to multiple models. Therefore, it may include features not applicable to your model.

Failure to follow the instructions or improper operation may cause damage to laundry or equipment, or result in personal injury. Please keep the manual near the appliance for easy access.

This appliance is intended to be used in household. If the appliance is used for professional, for-profit purpose or purpose exceeding normal use in a household, or if the appliance is used by a person who is not a consumer, the warranty period shall be equal to the shortest warranty period required by relevant legislation.

This appliance is not intended for use by persons (including children) with reduced physical, sensory or mental capabilities, or lack of experience and knowledge, unless they have been given supervision or instruction concerning use of the appliance by a person responsible for their safety.

Children should be supervised to ensure that they do not play with the appliance.

Children of less than 3 years should be kept away unless continuously supervised.

This appliance can be used by children aged from 8 years and above and persons with reduced physical, sensory or mental capabilities or lack of experience and knowledge if they have been given supervision or instruction concerning use of the appliance in a safe way and understand the hazards involved.

Children shall not play with the appliance. Cleaning and user maintenance shall not be made by children without supervision.

The maximum capacity in some cycles for dry clothes to be used is **Wash (12kg) /Dry (8kg)**.

The recommended maximum capacity for each program may vary. For optimal results, see "PROGRAM TABLE".

To connect the appliance to water supply, make sure to use the supplied water supply hose and gaskets. Water pressure has to be between 0.1-1 MPa (1-10 bar; 1-10 kp/cm²; 10-100 N/cm²).

Always use a new water supply hose to connect the appliance to water supply, do not reuse an old water supply hose.

For appliances with ventilation openings in the base, the ventilation openings must not be obstructed by a carpet.

If the supply cord is damaged, it must be replaced by the manufacturer, its service agent or similarly qualified persons in order to avoid a hazard.

ELECTRICAL SAFETY

This appliance complies with relevant safety standards.

Before connecting the appliance to the power mains, wait for at least 2 hours until it reaches room temperature.

This appliance must be repaired by an authorised service center, using only spare parts approved by authorised manufacturers. Any repairs or maintenance related to safety or performance should be conducted by trained professionals.

Do not attempt to repair the appliance by yourself. Repairs performed by unqualified personnel may result in personal injury or more serious error. Please consult your local service center and always insist on genuine spare parts.

Do not attempt to operate the appliance if it is damaged, defective, partially disassembled, or has missing or damaged parts, including damaged wires or plugs.

Do not excessively bend the power cord or place heavy objects on it.

Do not clean the inside or outside the appliance with spray water.

In case of flooding, please disconnect the power plug and contact the after-sales service center.

Models with a drying function enable automatic shutdown of the heater to prevent overheating. The heater automatically shuts off when the temperature exceeds the safety threshold and restarts when the temperature drops below the threshold.

Do not connect multiple power sockets, extension cords or dual adapters to the appliance. Do not connect the appliance to the power mains using an extension cord.

Do not connect the appliance to a power socket intended for an electric shaver or hair dryer.

Do not connect the appliance to a power socket intended for small loads.

Before connecting the appliance to the power supply, ensure that the electric voltage specified on the rating plate matches the Voltage of your socket.

The power socket must be securely grounded and the water supply must be unobstructed.

Do not connect the appliance to power mains using an external switching device such as a program timer, or connect it to power mains that is regularly switched on and off by the power supply provider.

Exhaust air must not be discharged into a flue designed to discharge combustion gases or other fuel exhaust gases.

INSTALLATION

Before using the appliance, be sure to remove the packaging (sponge, polystyrene foam, etc.) attached to the bottom of the appliance.

Please install the appliance correctly according to the instructions and connect it to the water and electricity supply (see "INSTALLATION AND CONNECTION").

Water piping and electrical wiring should be carried out by a fully trained technician or professional.

Do not install the appliance in a location where the door opening is restricted.

Do not install the appliance where the temperature may drop below 5°C, as its parts may be damaged in case of water freezing.

Place the appliance on a solid and level floor. If installed on a high platform, the appliance must be reinforced to prevent it from tipping over.

The end of the water discharge hose should reach into a water drain line.

This appliance should not be stored or used outdoors.

Avoid lint accumulation near the appliance.

Do not install the appliance near heaters or flammable materials.

Do not install the appliance in an area where gas leaks may occur. Ensure good ventilation to prevent the gases generated by the appliance from flowing back into the room and causing a fire.

USAGE

Remove the transport screws/rods before first use, otherwise serious damage may occur when starting the appliance (see chapter "INSTALLATION AND CONNECTION/Remove transport screws/rods"). Such damage is not covered by the warranty.

Check the appliance for damage during transportation. Never operate the appliance if it is damaged.

Use detergents suitable for the appliance and laundry care. We shall not be responsible for any damage or discoloration of gaskets and plastic parts resulting from incorrect use of bleaching or colouring agents.

Do not attempt to remove any panels or disassemble the appliance.

Do not press buttons with sharp objects such as pins, knives, or nails.

Do not touch the power plug or operate the appliance with wet hands.

This appliance is only suitable for regular washing or drying (for tumble dryer models). It cannot be used for dry cleaning.

Attempting to lift the heavy appliance may cause you to get injured. Do not attempt to lift the appliance yourself as your hands may be cut by its sharp edges.

Do not use protruding parts to move the appliance. Protruding parts on the appliance may be broken when lifting or pushing the appliance.

Do not wash laundry with large buttons or other heavy metal objects, and ensure that all pockets of the laundry are empty. To prevent odours and mildew, open the door at the end of the washing cycle to allow the drum to dry.

Do not leave metal objects in the drum for extended periods.

The door glass may be cracked by strong impacts. Handle with care.

Place laundry completely into the drum to prevent it from getting

caught in the door.

Cut off the water supply and unplug the power cord when the appliance is not in use.

Do not place any animals (such as pets) into the appliance.

TRANSPORT/TRANSPORT AFTER INSTALLATION

Assemble the transport screws/rods if you need to move the installed appliance (see chapter "INSTALLATION AND CONNECTION/Moving and Transporting After Installation"). Unplug the power cord before assembling the transport screws/rods!

Turn off the tap and unplug the appliance at the end of the washing cycle. Never unplug the appliance by pulling on the power cord. Always hold the power plug firmly and pull it straight out of the socket.

 Do not use detergents that contain solvents as this could lead to release of poisonous gases, damage to the appliance, and cause the risk of fire and explosion.

Do not open the appliance door by force while it is operating (High-temperature washing/drying).

Do not use the appliance after cleaning with industrial chemicals.

 Water drained during a high-temperature washing cycle is hot. Do not touch the water to prevent burns.

Laundry contaminated with edible oils, acetone, alcohol, petrol, kerosene, detergents, turpentine, wax and wax removers should be pre-washed with hot water and plenty of detergent before placing in the drum.

se softener or similar products according to the manufacturer's instructions.

Remove all items such as cigarette lighters or matches from pockets.

DANGER OF HOT SURFACE

At higher washing or drying temperatures, the door glass will heat up. Be careful to avoid burns. Make sure children do not play near the door glass. Do not touch the door glass during operation.

WATER OVERFLOW PROTECTION (WITH APPLIANCE SWITCHED ON)

If the water level in the appliance rises above normal level, then

the excess water level protection will be activated. It will shut off the water supply and start pumping out the water. The program is interrupted and an error is reported.

Do not wash or dry laundry made of foam rubber (latex foam), shower caps, waterproof fabrics, rubber products, or clothing or pillows containing foam rubber pads in the drum.



WARNING

If your appliance has a drying function, do not interrupt the program until the drying cycle is complete. If you need to interrupt it for any reason, carefully remove laundry to avoid burns. Quickly remove laundry and spread it out so that the heat is dissipated.

CHILD SAFETY

Before closing the appliance door and running the program, make sure there is nothing except laundry in the drum. Make sure no child climbed into the appliance drum and closed the door from the inside.

Do not leave the door open. Children may hang on the door or climb into the appliance, causing damage or injury.

Keep all packaging materials out of the reach of children, as they may pose a danger.

Keep detergent and softener out of reach of children.

SERVICING

Repair costs resulting from damage caused by incorrect connections, improper installation and use, or repairs made by unauthorised personnel are the responsibility of the user and are not covered by the warranty.

The warranty does not cover consumables, minor colour deviations, increased noise due to appliance age that does not affect the functionality of the appliance, and aesthetic defects on components that do not affect the functionality and safety of the appliance.

PRODUCT DESCRIPTION

FRONT

- 1 Control unit
- 2 Program selector knob
- 3 Detergent drawer
- 4 Door
- 5 Pump filter cover

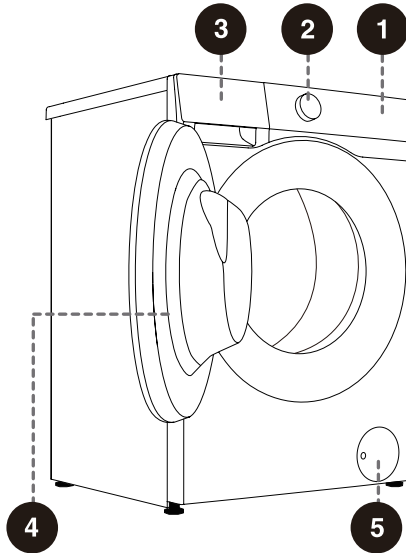

BACK

- 1 Water supply hose
- 2 Power cord
- 3 Water discharge hose
- 4 Adjustable feet
- 5 Transport screws/rods

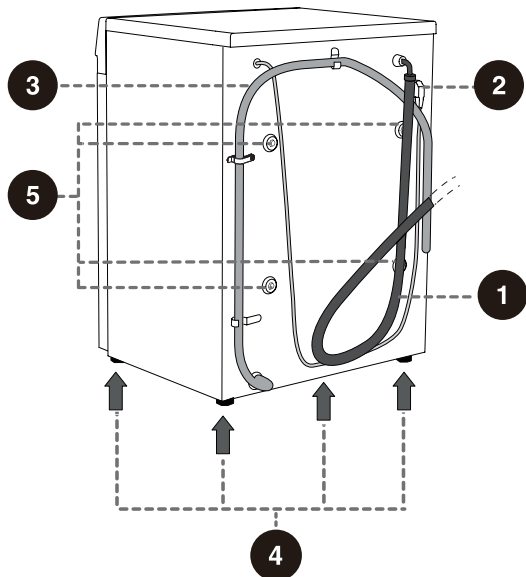

 The illustrations in this manual are for illustrative purposes only. Due to product improvements and series expansion, the appearance, color, and functional components of the product you receive may differ from those shown in this manual. Please refer to the actual product.

SPECIFICATIONS

(DEPENDING ON THE MODEL)

Max. load	12 kg/8 kg
Net Weight	75 kg
Rated Voltage	220-240 V~
Frequency	50 Hz
Rated Power	1900 W/1150 W

DIMENSIONS (MM)

Index	Dimensions (mm)
A	595
B	845
C	570
D	595
E	630
F	1125

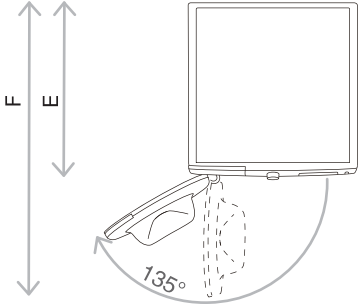
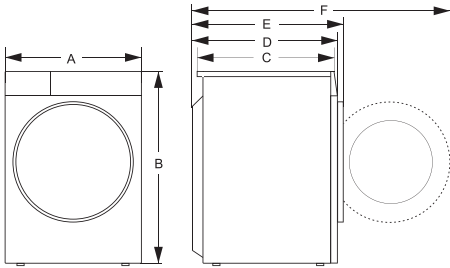



E = appliance depth
F = Depth with door open

INSTALLATION AND CONNECTION

Packing/Packaging

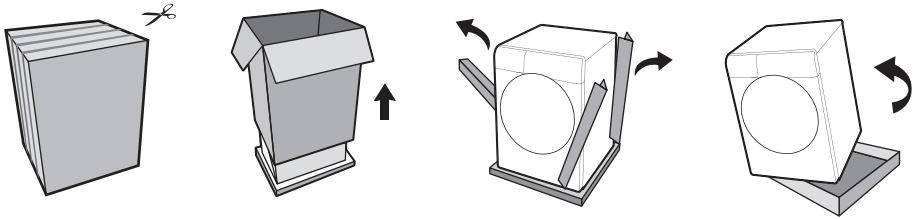
 Please first remove all the packaging and foam, especially the foam base. When unpacking the device, please do not use sharp objects to damage it. Keep packaging materials (plastic bags, other plastic parts, etc.) out of reach of children.



 The process of packing the machine is just the opposite of unpacking above.

 Please check the device for any damage. Do not use it if it is damaged, and immediately contact after-sales service.

The accessories included with this device include one or more of the following:

- User Manual;
- 4 transport screw covers;
- Water inlet hose;
- Water drain hose bracket;
- Wrench;
- Noise reduction board/sponge strip/none (subject to the actual model).

Different models have different configurations, and the accessories included with this device are subject to the actual configuration of the model.

HOW TO INSTALL THE NOISE REDUCTION BOARD:

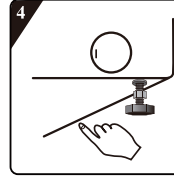
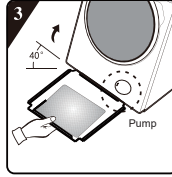
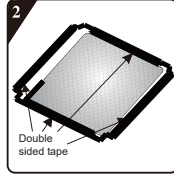
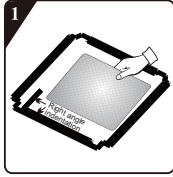

1 Before installing the noise reduction board align and paste the acoustic absorption wool with and along the right-angle impression on noise reduction board (this procedure is unnecessary for some of the models without acoustic absorption wool).

3 Incline the appliance to an angle of 40° and let the side with right-angle notch face towards front of the appliance, as shown in the figure. Insert the side with oblique-angle notch between two foot screws at back of the appliance completely in place. Then, install the noise reduction board and ensure that it contacts with bottom of the appliance closely.

2 Remove surface paper on double sided tape at four sides of the noise reduction board.

4 Press the double sided tape on four sides manually to secure the noise reduction board to the appliance firmly.

HOW TO INSTALL THE SPONGE STRIPS:

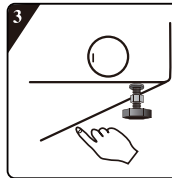
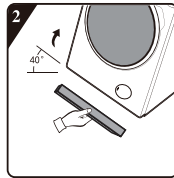
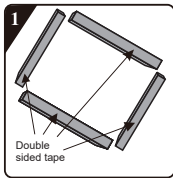

1 Remove surface paper on double sided tape on the sponge strips.

3 Press down to secure the sponge strips firmly.

2 Incline the appliance to an angle of 40° and attach sponge strips on the bottom of the appliance with the two long sponge strips at the front and rear support positions, and the two short sponge strips at the left and right support positions.

REMOVING THE TRANSPORT SCREWS/RODS

 Disassemble the transport screws/rods once all packaging has been removed. A blocked appliance may be damaged when it is switched on for operation. Such damage is not covered by the warranty.

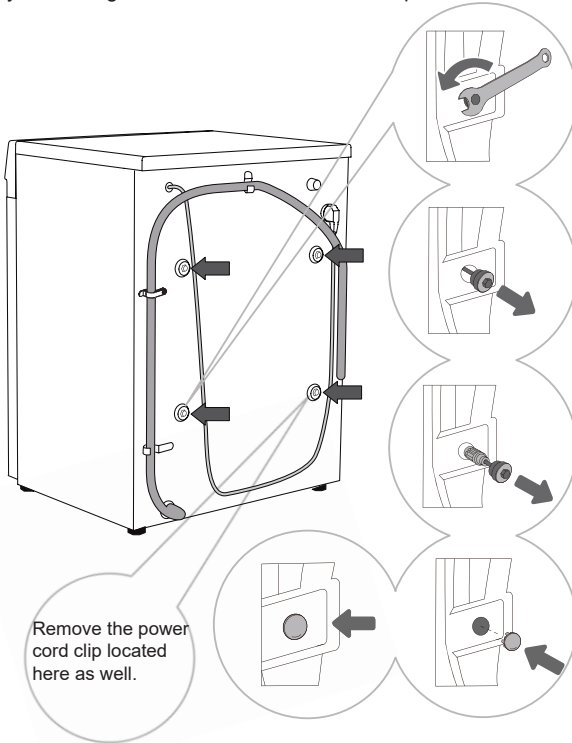

1 Move aside the water discharge hoses and use an appropriate wrench to loosen the four screws on the back in the counterclockwise direction as indicated by the arrows. Loosen the screws approximately 30 mm.

2 Pull all 4 transport screws/rods horizontally.

3 Pull out the transport screws/rods along with the rubber and the plastic parts.

4 Cover the screw holes with plastic plugs. The plastic plugs are supplied in the bag with the appliance user manual (the support set).

 Save the transport screws/rods in case you have to transport the appliance again later (to reinstall the transport screws/rods, follow the above procedure in reverse order).

INSTALLATION LOCATION

💡 Place the appliance on a solid and level floor to keep it stable. The floor should be clean and dry; otherwise, the appliance may slide. Also, clean the bottom surface of adjustable feet.

ADJUSTABLE FEET

Use a spirit level and the supplied wrench.

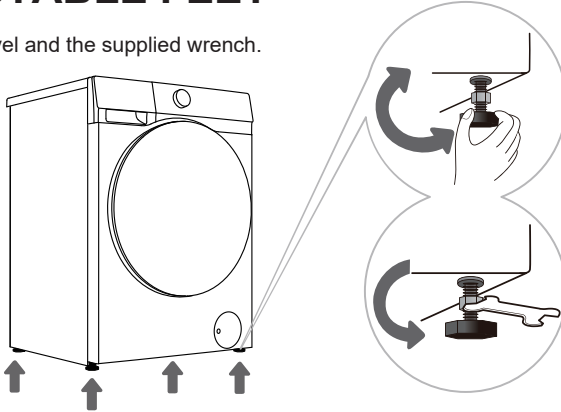

1 Rotate the adjustable feet to level the appliance lengthwise and crosswise. The feet allow levelling by +/-2 cm.

2 After adjusting the height of the feet, use the supplied wrench to securely tighten the locknuts by turning them counterclockwise (see Figure).

- 💡 Incorrect levelling of the appliance may cause vibration, appliance sliding across the room, and loud operation. Incorrect levelling of the appliance is not subject to warranty.
- 💡 Sometimes, unusual or louder noise may appear during appliance operation. These are mostly the result of improper installation.

INSTALLATION CLEARANCE

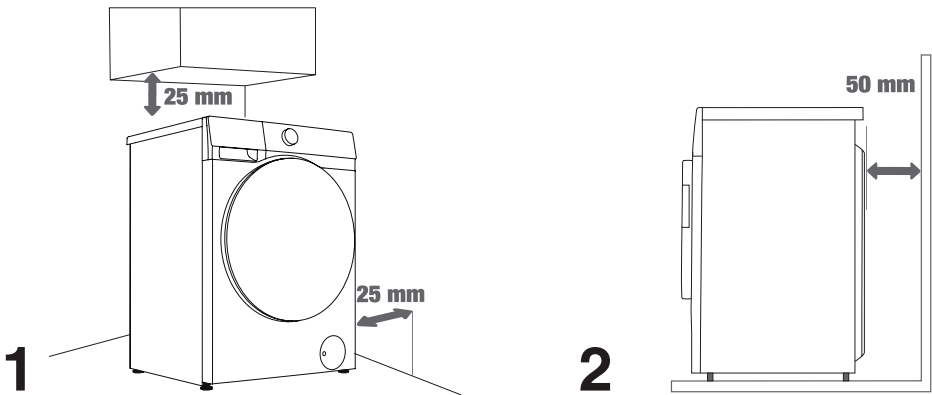

💡 The appliance may not be in contact with a wall or adjacent furniture. For optimum appliance operation, we recommend observing the clearances from the walls as indicated in the figure. In case of failure to observe the minimum required clearances, safe and correct appliance operation cannot be ensured. Moreover, overheating can also occur (Figures 1 and 2).

CONNECTING TO WATER SUPPLY

The supplied water supply hose varies by model. Please choose the appropriate connection method based on the actual water supply hose.

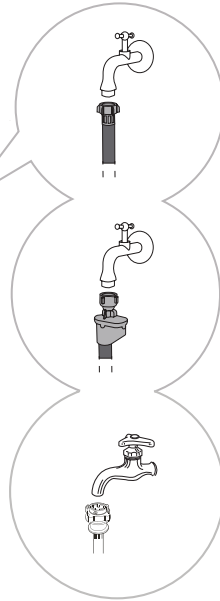
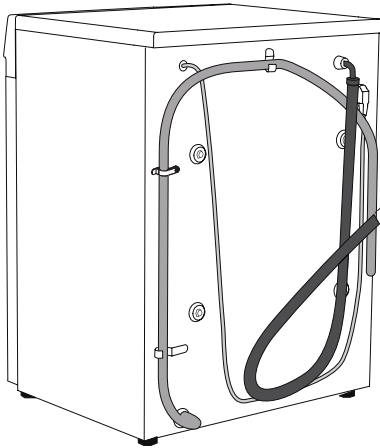



A EUROPEAN
WATER SUPPLY
HOSE CONNECTION

B AQUA STOP
CONNECTION

C CHINESE WATER
SUPPLY HOSE
CONNECTION

 For normal appliance operation, the pressure in the water mains should be between 0.1-1MPa (1-10 bar; 1-10 kp/cm²; 10-100 N/cm²). Minimum dynamic water pressure can be determined by measuring the water flow. In 15 seconds, 3 litres of water should flow from a fully open tap.

 Only use the water supply hose supplied with the appliance. Do not use any used or other hoses.

 Make sure the hose is not damaged. If the hose is degraded, brittle, or cracked, it has to be replaced.

 This appliance is designed for cold water only. Do not connect it to hot water.

EUROPEAN WATER SUPPLY HOSE CONNECTION

Tighten the water supply hose by hand to ensure proper sealing (maximum torque: 2 Nm). Check the sealing for leaks.

Do not use pliers or similar tools as they may damage the nut threads.

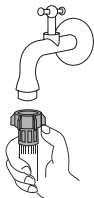

AQUASTOP CONNECTION

If an internal tube or hose is damaged, a shut-off system is activated that cuts the water supply to the appliance. In such case, the control glass (a) will turn red. Replace the water supply hose.



- ⚡ Do not dip the water supply hose with the AquaStop system in water as it contains an electric valve.
- ⚡ The water supply hose can be connected without a non-return valve.

CHINESE WATER SUPPLY HOSE CONNECTION

1. Select a suitable tap with a tip length greater than 10 mm. The outlet end must be flat. If it is uneven, smooth it out with a file to prevent leakage after installation (see Figure 1).
2. Push the slider down to disconnect the water supply hose connector from the inlet assembly (see Figure 2).
3. Loosen the four screws on the water supply hose connector, then attach the hose to the tap. If the tap diameter is too large for the connector, loosen the screws and remove the sleeve (see Figure 3).
4. Evenly tighten the four screws on the water supply hose connector and secure the nuts (see Figure 4).
5. If the appliance is to be used once or several times in a week, push the slider down without disconnecting the water supply hose connector to avoid damaging the fixing screws.

-⚡ NOTE: The exposed thread length before tightening the nut is approximately 4 mm and less than 2 mm after tightening (Figure 4).

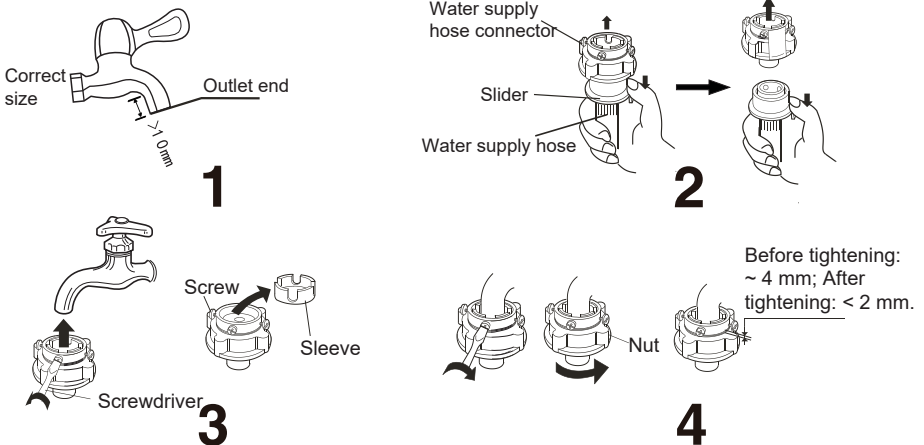

CHECKING THE CONNECTION BETWEEN THE WATER SUPPLY HOSE AND THE TAP

1. Gently pull the water supply hose to check if the connection is secure.
2. Open the tap to check for leaks.
3. The water supply hose should not be twisted or bent.
4. Check the water supply hose before each use to prevent incorrect connection.



CONNECTING THE WATER SUPPLY HOSE TO THE APPLIANCE

Connect the water supply hose nut to the water supply hose connector of the appliance. Tighten the nut and shake it gently to check that it is firmly secured, as shown in the right figure.

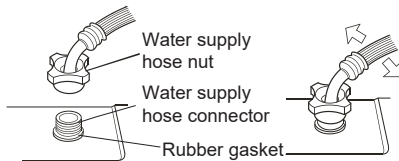

NOTE:

1. Tighten the nut evenly. Avoid rotating the water supply hose, as this may cause damage.
2. Do not remove the rubber gasket. Before each use, check that the gasket is not detached or damaged. If damaged, please contact after-sales service immediately.

CONNECTING AND SECURING THE WATER DISCHARGE HOSE

Feed the water discharge hose into a washbasin or a bathtub, or connect it directly to a drain (discharge hose minimum diameter 4 cm). The vertical distance from the floor to the end of the discharge hose may be 70 to 100 cm. It can be attached in three ways (A, B, C).

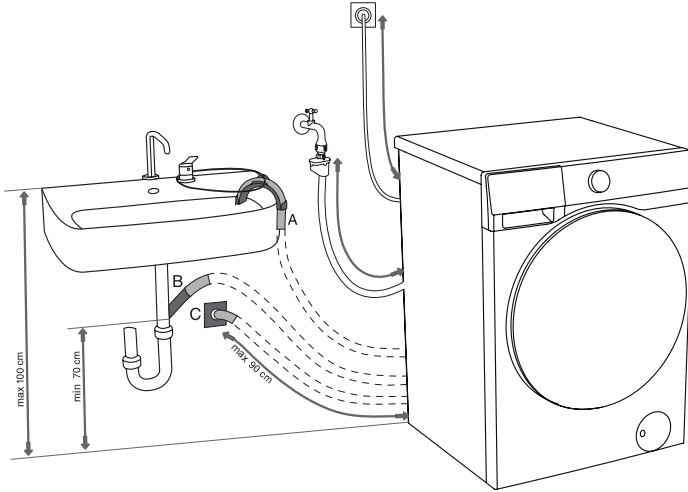

A The discharge hose end may be placed over a sink or a bathtub. Use a string fed through the opening in the elbow support to attach the hose and prevent it from slipping to the floor.

B The discharge hose may also be attached directly to the sink drain. A sink that is too small is not acceptable. Be careful as the drained water may be hot.

C The discharge hose can also be attached to a wall drain with a trap. Such trap should be properly installed to allow cleaning.

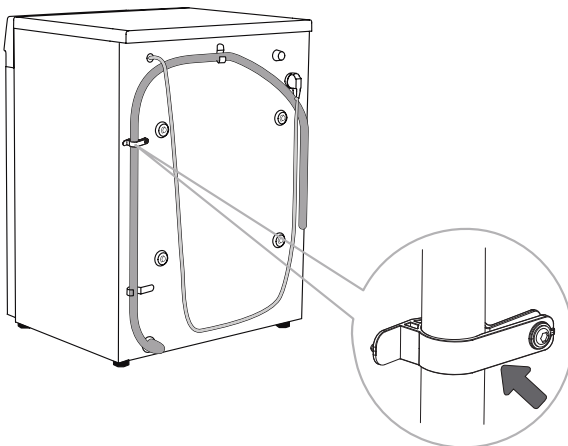

D The discharge hose has to be attached to the clips on the back of the appliance, as shown in the figure.

! These clips must not be removed as this may prevent normal washing.

! Make sure the drain hose is not damaged.

! If the discharge hose is not correctly attached, safe and correct appliance operation cannot be ensured.



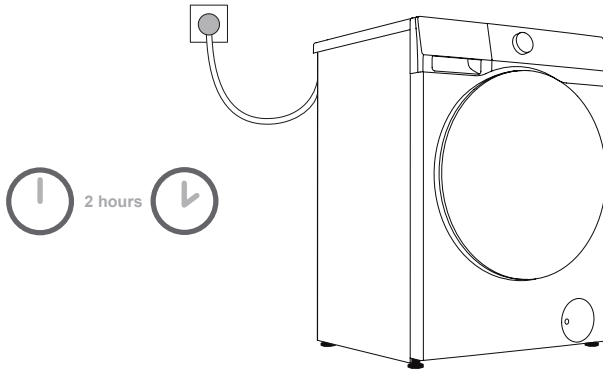

CONNECTING TO POWER MAINS



 **Before connecting the appliance to the power mains, wait for at least 2 hours until it reaches room temperature.**

Connect the appliance to a grounded power socket. After installation, the socket should be freely accessible. The socket should be provided with grounding protection. Information on your appliance is indicated on the rating plate.

 **We recommend using over-voltage protection to protect the appliance in case of a lightning strike.**

-  The appliance may not be connected to the power mains using an extension cord.
-  Do not connect the appliance to a power socket intended for small loads.
-  Do not plug or unplug the appliance when your hands are wet.
-  Any repair and maintenance of the appliance should be performed by trained experts.
-  A damaged power cord may only be replaced by a person authorized by the manufacturer.

TRANSPORTATION AFTER INSTALLATION

 If you need to transport an installed device, first unplug the power plug, turn off the tap, remove the water inlet and drain hoses, and make sure the detergent box and door are closed properly.

Be sure to reinstall the transport screws to prevent vibrations during transport from damaging the device (see "Installation and connection/removal of transport screws"). If you accidentally lose the transport screws, you can order them from the manufacturer.

Pack all packaging materials (plastic bags, other plastic parts, etc.).

 The device is heavy. Please use at least two people to move it. When transporting, do not hold protruding parts such as the door, top cover, etc., to prevent them from falling off or being damaged.

 After transport, let the device sit for at least 2 hours before connecting it to the power supply. The device should be installed and connected by trained technicians.

 Please read the instructions carefully before reconnecting the device. Damage caused by improper connection or use is not covered by the warranty.

Transport and Handling Method

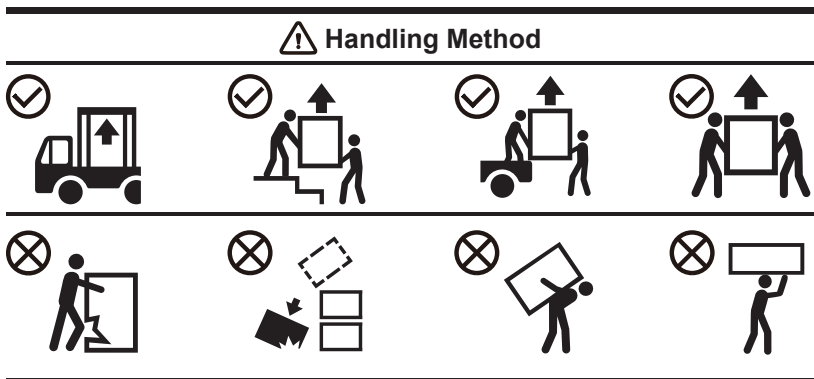

BEFORE USING THE APPLIANCE FOR THE FIRST TIME



























FIRST USE

This appliance has been tested at the factory and may contain a small amount of water residue. It is recommended to run a “Drum Clean” (or other high-temperature) program to remove any residual water from the drum.

● Connect the appliance to the power mains and open the water tap. There should not be any laundry in the drum. Select and start the program.

⚠ Do not use any solvents or cleaning agents that could damage the appliance (please observe the recommendations and warnings provided by the cleaning agent manufacturers).

HEED THE LABELS ON THE LAUNDRY



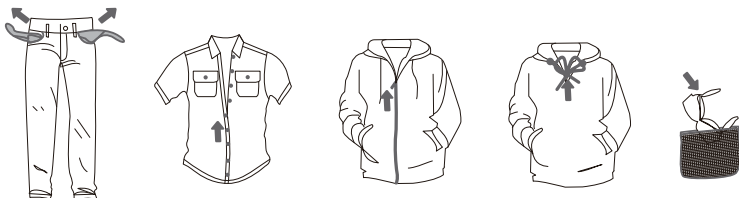

Washing	Max. washing temp. 95°C  	Max. washing temp. 60°C  	Max. washing temp. 40°C  	Max. washing temp. 30°C  	Hand wash only 	Do not wash 
Bleaching	Bleaching in cool water 			Bleaching not allowed 		
Dry cleaning	Dry cleaning with all agents 	Petroleum solvent R11, R113 	Dry cleaning in kerosene, pure alcohol, and R113 	Dry cleaning not allowed 		
Ironing	Hot ironing, max. 200°C 	Hot ironing, max. 150°C 	Hot ironing, max. 110°C 	Ironing not allowed 		
Drying	Dry flat (place on a flat surface) 	Drip dry  Line dry 	High temperature  Low temperature 	Do not tumble dry 		

PREPARING THE WASHING PROCESS









- Sort the laundry by type of fabric (cotton, blends, silk, wool, etc.), care label instructions, colour (white, coloured), and soiling.
- Empty pockets; remove metal items that may damage the laundry or appliance; fasten buttons and turn clothing with buttons or embroidery inside out; close all zippers; tie strings on clothing with drawstrings.
- Place sensitive clothes and small or lightweight items in a special-purpose laundry washing bag and wash them together with other laundry.
- Turn items prone to pilling or long-pile fabrics inside out before washing.
- Stains that are left for too long can be difficult to remove. Treat soiled areas such as cuffs and collars before washing (see chapter “Stain Removal Tips”).
- Do not wash heavy comforters, plush toys, or items in laundry washing bags separately in the drum to avoid imbalance alarms.



NON-WASHABLE AND NON-DRYABLE LAUNDRY

 <p>Leather and fur products (risk of deformation)</p>	 <p>Rayon and its blended products (risk of discolouration or deformation)</p>	 <p>Large thick rubber cushions (risk of damage or malfunction)</p>
 <p>Hats with hard materials (risk of appliance damage and malfunction)</p>	 <p>Cushions, pillows, articles with cotton wadding, foam and other sponge materials, carpet covers (risk of damage or malfunction)</p>	<p>Others: Wrinkled or embossed clothes; coated down jackets; crepe fabrics; easily deformed clothes (suits, jackets, ties, dresses, etc.); easily fluffing clothes (velvet, cotton flannel).</p>

NON-DRYABLE LAUNDRY (FOR TUMBLE DRYER MODELS)

 <p>Any laundry marked by graphic (risk of laundry damage)</p>	 <p>Wool clothes (risk of shrinkage or fur loss)</p>	 <p>Tights and stockings (risk of damage or deformation)</p>	 <p>Sizing clothes</p>
 <p>Cushions or clothes with furs (risk of damage or malfunction)</p>	 <p>Comforters (risk of damage or malfunction)</p>	 <p>Clothes with lace or embroidery, and new synthetic fibers (very fine fibers) (risk of deformation)</p>	 <p>Silk</p>

 Non-washable and non-dryable laundry includes but is not limited to the above items.



 Wet items that are still dripping are not suitable for tumble drying and may trigger an alarm.

ADD DETERGENT/SOFTENER

Detergent box

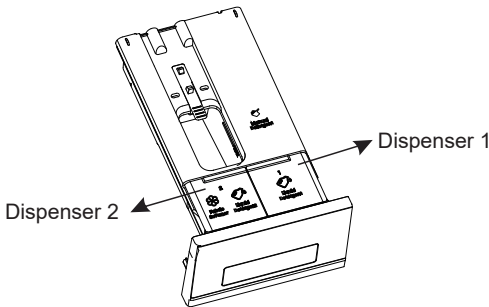
1. The automatic dispensing model has the function of automatically dispensing detergent/softener, which can automatically add the appropriate amount of detergent/softener. When used for the first time, the system defaults to turning on the automatic dispensing function of detergent and softener.
2. When the automatic dispensing function is selected, the appliance will automatically dispense detergent/softener, and you can adjust the automatic dispensing gear according to the amount required. The appliance will remember the dispensing gear setting when the last wash was completed.
3. If you do not want to use the automatic dispensing function, you can turn it off in the settings and add detergent and softener manually when washing clothes.
4. Softener/detergent can be added to "Dispenser 2"; please ensure it is added according to the function settings. You can choose the same or different detergent as in "Dispenser 1" as needed. For specific dispensing settings, please refer to the "Dispenser 2" settings.
5. If the amount of detergent/softener in the detergent/softener box is insufficient, the corresponding liquid shortage reminder icon on the display screen will light up or flash red, please add detergent/softener in time. The maximum capacity of "Dispenser 1" is 0.65L, and that of "Dispenser 2" is 0.4L. Do not add more than the MAX scale mark. Please close the detergent box drawer completely after adding.



Detergent box	
	Manual Detergent compartment
	Liquid Detergent compartment
	Fabric Softener/Liquid Detergent compartment

PRECAUTIONS FOR USE

1. Always use a high-efficiency neutral low-foaming detergent suitable for this appliance. Do not use clumpy powder detergent.
2. Do not add detergent manually when using the automatic dispensing function.
3. Do not overfill the detergent/softener box to prevent the detergent/softener from overflowing. After filling the detergent/softener, make sure the detergent box drawer is completely closed before starting the washing program.
4. Before installing, moving, transporting or adjusting the appliance, remove or secure the detergent box to prevent the detergent and softener from overflowing.
5. Corrosive descaling agents may damage the appliance. Do not use solvents. Do not wash clothing that has been cleaned with solvents or flammables.
6. If manual dispensing is required, you can turn off the automatic dispensing function and add detergent manually:
- 6.1 The amount of detergent used depends on the type of clothing, the degree of soiling, the color of the clothing, and the washing temperature. Please use the appropriate amount.
- 6.2 Excessive detergent may cause foaming, which will affect the washing performance. If the appliance detects too much foam, it may pause the program for defoaming.
- 6.3 If insufficient detergent is used, it may result in poor washing performance and could also lead to the formation of limescale in the drum and water hoses.
- 6.4 When adding powder detergent manually, it is advisable to add it right before the washing program begins. If you add it in advance, make sure that the detergent box compartment is completely dry; otherwise, the powder detergent may harden and clump before the washing program starts.
7. Do not use concentrated or highly concentrated detergent or softener (maximum permissible viscosity is 800mpa.s). Use only after diluting with water.
8. Do not put powder detergent in the automatic dispensing detergent compartment.
9. To prevent the detergent/softener in the detergent box from drying up, do not open the lid of the detergent box for a long time. Pull out the compartment only when filling or changing the detergent.
10. Keep detergent and softener out of the reach of children.
11. The detergent dispenser drawer does not have a dedicated compartment for adding disinfectants, so it is not recommended to add disinfectants.

PUT IN THE LAUNDRY

Open the machine door, make sure there is no foreign matter in the drum, and put the clothes loosely into the drum.

Close the machine door and hear a "click" sound, indicating that the appliance door is closed tightly.

 Do not overload the drum! Refer to the "Program Table" for the maximum load. If the drum is too full, the clothes may not be cleaned effectively.

 Please put the laundry into the drum completely to prevent the clothes from getting caught in the door.

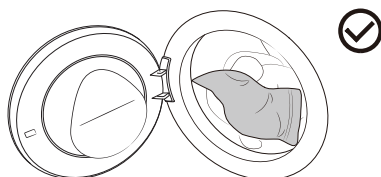
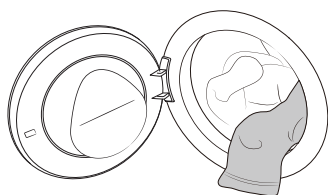

FIRST TIME USE

Tap "⏻" to power on and enter the startup navigation.

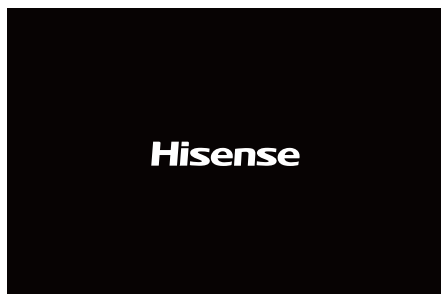

Configure Language and WLAN according to the startup navigation and actual needs of the user, and complete the Operating tips.

Language

Set the language, the default is English, turn the main knob to select, and then tap "○" to confirm the selection and go to the next step.

WLAN

The appliance is bound to the network, and the WLAN connection of the appliance is completed according to the prompts.

If you do not need to connect to the network, press and hold "○" to skip.

Operating tips

Interface operation guide, tap "○" continuously to switch the operation guide interface, and enter the main interface after completion.

PROGRAMS AND FUNCTIONS







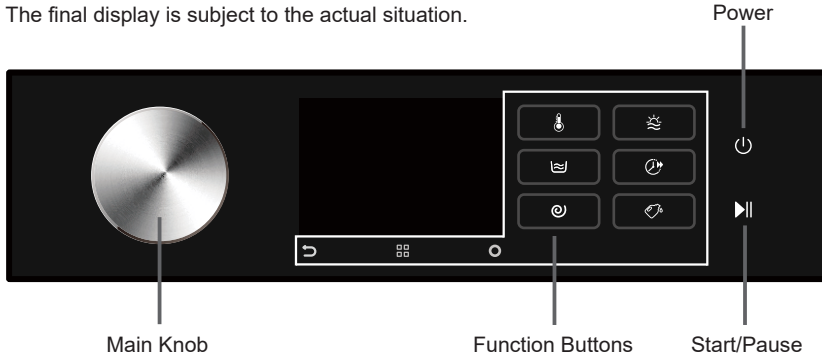

Main interface

This machine adopts the control method of touching the function keys + rotating the main knob. The Power, Start/Pause, Back, Options, Confirmation button and other function buttons are operated by touching the buttons; the program selection is operated by rotating the main knob; additional functions and other settings are operated by rotating the main knob + touching the function buttons.

The final display is subject to the actual situation.



Icon description

Icon	Name	Description
	Power	Used to turn on/off the appliance.
	Start/Pause	Used to start/pause a program.
	Back	Tap to return to the previous interface; long press to return to the main interface.
	Options	Tap to enter the selection of additional functions; long press to enter the system function settings.
	Confirm	Used to confirm the current selection.
	WLAN	This icon is displayed when the appliance is connected to the network.
	Remote Control	This icon is displayed when the Remote Control function is turned on.
	Door Lock	This icon is displayed when the door is locked.

PROGRAM TABLE

Tap the Power button to turn on the appliance, then turn the main knob to select the appropriate program based on the type of clothing and the degree of soiling. During operation, the main knob will not turn automatically.

Program	Function	Maximum load (kg)	Maximum speed (rpm)	Program description
Eco 40-60 -	W	12	1400	This program is suitable for washing cotton clothes that are lightly soiled.
	WD	8		
Cotton (Cold, 20°C, 30°C, 40°C, 60°C, 90°C)	W	12	1400	This program is suitable for washing cotton or linen fabrics that are moderately and heavily soiled.
	WD	8		
Synthetics (Cold, 20°C, 30°C, 40°C, 60°C)	W	6	1400	This program is suitable for medium soiled synthetic fabrics and cotton fabrics.
	WD	6		
Cotton Dry -	D	8	/	This program is suitable for drying wet synthetic fabrics and cotton fabrics after spinning. Do not add detergent/softener for this program.
Synthetics Dry -	D	6	/	This program is suitable for drying wet cotton or linen fabrics after spinning. Do not add detergent/softener for this program.
Auto (Cold, 20°C, 30°C, 40°C)	W	7	1400	This program can automatically adjust the main wash time and rinse times according to the weight of the laundry and is suitable for washing lightly soiled clothing.
	WD	7		
Refresh -	N	2	/	This program is used for sanitizing, dewrinkling, and deodorizing a small load of dry clothes. The faucet must be turned on, and neither detergent nor softener should be added.
Baby Care (40°C, 60°C, 90°C)	W	2	1400	This program is suitable for washing baby clothes, underwear, etc., and sterilizes them at high temperatures. It is not recommended to add softener for this program.
	WD	2		
Allergy Care (60°C)	W	2	1400	This program is suitable for washing clothes that are resistant to high temperatures and are not easy to fade. It removes allergens such as pollen, mites, parasites, etc. through high temperatures.
	WD	2		
Pets (Cold, 20°C, 30°C, 40°C, 60°C)	W	4	1400	This program is suitable for washing clothes that are covered in pet hair.
	WD	4		
Full load 49' (Cold, 20°C, 30°C, 40°C)	W	12	1400	This program is suitable for washing daily wear made of cotton, synthetic fabrics, or blended fabrics within a short period of time.
Power 30' (Cold, 20°C, 30°C, 40°C)	W	5	1400	This program is suitable for washing a small amount of heavily soiled laundry, with an intensive wash cycle in a short period of time.
	WD	5		
Quick 15' (Cold, 20°C, 30°C, 40°C)	W	2	800	This program is suitable for washing a small amount of laundry or lightly soiled laundry. If you change the default setting, the washing time will be longer.

Program	Function	Maximum load (kg)	Maximum speed (rpm)	Program description
Wash & Dry 49' -	WD	1	1400	This 49-minute wash and dry program is suitable for lightly soiled clothes, such as T-shirts, shirts, skirts, etc., which need to be changed every day. It is recommended not to wash more than 3 pieces of clothes at a time.
Bedding (Cold, 20°C, 30°C, 40°C, 60°C)	W	4	1400	This program is suitable for washing large-sized clothes, such as curtains, sheets, quilt covers, etc.
	WD	4		
Wool (Cold, 20°C, 30°C, 40°C)	W	3	600	This program is suitable for washing machine washable woolen clothes (refer to the laundry label requirements).
Rinse+Spin -	W	12	1400	This program is for separate rinsing and spinning of laundry. Do not add detergent for this program.
	WD	8		
Drum Clean (90°C)	WD	/	800	This program is used to clean the drum and remove detergent residues, as well as bacteria that accumulate and grow when washing at low temperatures. Do not add detergent/softener for this program.
Spin -	S	12	1400	This program is used for separate spinning of laundry. Do not add detergent/softener for this program.
	SD	8		

W → Wash only D → Dry only WD → Wash and dry N → Neutral S → Spin only SD → Spin and dry

Tips:

- After selecting the Quick 15' program, tap the  button to switch between the Quick 15' and Wash&Dry 49' programs.
- The Refresh program is a dry clothing care program that allows you to set the care time with the Dry Level function, which is available in a range of 30/40/50 minutes.

Note

- (1) Water temperature: Select the appropriate water temperature according to the selected washing program. When washing, follow the clothing manufacturer's washing label or instructions to avoid damaging the clothing.
- (2) The actual water temperature may differ from the stated program temperature.
- (3) Test results depend on water pressure, water hardness, inlet water temperature, room temperature, type and amount of laundry, degree of soiling, detergent used, power supply fluctuations and other options selected.
- (4) If you add too much laundry during the wash cycle, the laundry may be washed less efficiently because the machine initially detects a lower weight and adds less water. Insufficient water can also cause damage to the laundry and the wash time will be longer.
- (5) Drum Clean (if available): The drum must be emptied before using the Drum Clean program. It is recommended to run it at least once a month.
- (6) For descaling, use a descaling agent with corrosion protection (only use non-corrosive descaling agents and follow the instructions for use of the descaling agent). Run the "Drum Clean" (or other high temperature) program several times to remove any descaling agent residues and complete descaling. It is recommended to descaling at least once every six months.

 The maximum or nominal load applies to laundry prepared in accordance with the relevant provisions of standard IEC60456.

 For better washing performance, we recommend that you fill no more than 2/3 of the drum volume when using the Cotton program.

ADDITIONAL SETTINGS AND FUNCTIONS

After starting up, the display will show the default program and parameters. If you use the default parameters, tap the "Start/Pause" button to start the program. Users can select appropriate programs and parameters and add additional functions as needed.

After tapping the "Start/Pause" button to start, some of the set functions cannot be changed. If you need to change the settings, press and hold the "Power" button to shut down, and restart to reselect the program and function.

■ Before starting the program, select the program using the main knob, and tap the function button to set the Temp., Rinse, Spin, Steam, Quicker, and Anti Crease functions. Different programs have different optional additional functions and gear selection ranges.

Power

Used to turn on/off the appliance.

If you need to shut down the program during operation, press and hold the "Power" button to shut down. When the program is running, if no operation is performed for a period of time, the appliance will automatically turn off the screen and enter the energy-saving state. Turn the main knob or tap the "O" button, the start/pause button, or the power button to wake up the screen. In standby mode or when the program ends, if no operation is performed for a period of time, the appliance will automatically turn off the screen. If no operation is performed for a period of time after the screen is turned off, the appliance will automatically shut down. In the alarm state, the appliance will not turn off the screen.

Start/Pause

Start/pause the program.

If the door is not closed or locked, an alarm will be displayed on the screen after pressing "Start".

Temp.

Used to select the washing temperature before starting the program.

Tap this option to set the wash temperature before starting the program. Tap continuously to cycle through the setting gears. The temperature can be selected in gears: Cold/20/30/40/60/90°C. The heating temperature that can be set for each program is different.

Rinse

This function changes the default number of rinse cycles.

Before starting the program, tap this option to set the number of rinses. Tap continuously to cycle through the set gears. The number of rinses can be selected: 1/2/3/4/5 times. The number of rinses that can be set for each program is different.

Spin

This function allows you to adjust the spin speed of the program.

Before starting the program, tap this option to set the program speed. Tap continuously to cycle through the set gears. The speed options are: 0/400/600/800/1000/1200/1400rpm. The speed range that can be set for each program is different. Select "0rpm" and the appliance will not spin, but only drain water.

Cycle Mode

This function can switch the Cycle Mode of the program.

The current mode is displayed for the first time, and the default is single wash. Tap it again to cycle between "Wash&Dry/Dry/Wash".

Quicker

This function reduces the washing time of the program and speeds up the washing process. Before starting the program, tap this option to shorten the program time. Tap again to cycle through the gear settings in Quicker.

Cotton, Synthetics, and Baby Care can select two gears, and some program gears cannot be selected. Different gear settings correspond to different maximum load capacities of the programs. For programs with automatic weighing, selecting this function will cancel automatic weighing, and deselecting this function will restore automatic weighing.

Auto Dose

The smart dispensing function for Detergent/Softener is enabled by default.

Tap this option to enable/disable this function. To add manually, please disable this function. If it is disabled, you need to manually pour the detergent required for a single wash into the "Manual Detergent" compartment of the detergent box.

Long press to enter the gear setting interface, adjust the dispensing amount of Detergent/Softener according to your needs, and cycle between Off/Less/Standard/More. The default setting is Standard. Select the Off gear to disable the corresponding Detergent/Softener smart dispensing. If the Detergent/Softener is insufficient, a corresponding red icon will be displayed on the display screen as an alert. Please open the detergent box and add the detergent/softener as needed.

Please keep the detergent drawer closed during the program.

Additional functions

■ Tap  to enter the additional function settings interface:

Before starting the program, you can set additional functions such as Remote Control, Mute, Delay End Anti Crease, Dry Level, Cold Wash, PreWash, Steam, Stain Removal, as needed. After the program is started, users can set the Child Lock function if desired.

Turn the main knob to select additional functions, tap "○" to confirm the selection, and tap it again to cancel the selection. The corresponding icon is lit to indicate that this function is enabled. Different programs have different additional functions that can be selected.

Remote Control

This function can activate/deactivate the remote control module of the appliance.

Turn the main knob to select this function, tap "○", the  icon lights up, and the Remote Control function is turned on. The same operation can be used to turn off Remote Control.

Before activating the Remote Control function, check to make sure that the WLAN function is turned on and connected normally, and the door is properly closed.

When the WLAN function is turned on and connected normally, but the  icon on the screen is not lit, you can view the status or set the program parameters and function items (depending on the different permissions of the model) through your mobile phone, but you cannot start the program remotely.

When the WLAN function is turned on and connected normally, and the  icon on the screen is on, you can set the program parameters and function items through your mobile phone, and you can start the program remotely.

After turning on the Remote Control mode, if there is no operation on the entire machine and the App for a period of time, it will enter the Energy Saving mode, and it will automatically shut down if there is no operation within 7 days.

Child Lock

This appliance features a Child Lock function to prevent accidental operation by children and external interference with the program.

Turn the main knob to select this function, tap "○", the  icon lights up, and the Child Lock function is turned on. The same operation can be used to release Child Lock.

After the program ends, the Child Lock function is automatically canceled.

Mute

This function shields other sounds except the alarm sound and reduces noise. Turn the main knob to select this function and tap "○" to activate/deactivate.



Delay End

This function allows you to schedule laundry at your convenience. Please select the program and function, and then proceed to make a reservation for that function.

Turn the main knob to select this function, tap "○" to enter the reservation time selection interface, and turn the main knob to select the reservation end time. Tap "○", the reservation time is lit; tap the "Start/Pause" button, the reservation is started.

After the reservation is set, if you change the program and reset parameters and functions (except for the Anti Crease function) before the function activates, the reservation will be automatically canceled.

The reservation time is the end time of the program, including the entire program running time, so the reservation time must be greater than the program running time, and the maximum time cannot exceed 24 hours.

 Before activating the reservation function, please ensure the appliance door is properly closed and the "" icon on the display is lit.

Anti Crease

This function activates the Anti Crease mode, which rotates the inner drum intermittently after the program ends to prevent wrinkles from forming when clothes are not taken out for a long time.

After selecting the program, turn the main knob to select this function and tap "○" to activate/deactivate. When this function is activated, the appliance automatically enters Anti Crease mode at the end of the program.

During the operation of the Anti Crease function, tap the Start/Pause button to end this function. If no operation is performed, the program will automatically end after a maximum of 12 hours by default. The Anti Crease function cannot be set when the spin speed is selected as "0rpm".

Dry Level

This function allows you to select the drying level.

In the "Wash&Dry/Dry" mode, turn the main knob to select Dry Level, and tap "○" to enter the drying level selection interface. Turn the main knob to cycle through the set levels. The drying levels are: Cupboard/Iron/Extra Dry/Time Dry.

"Cupboard" is for drying clothes to a state that they can be worn immediately.

"Iron" means that the clothes contain a small amount of water after drying and can be ironed again.

"Extra Dry" is for drying clothes to a state that they can be stored.

"Time Dry" refers to timed drying, allowing you to choose the appropriate drying time based on the type and quantity of clothes.

The optional range for "Time Dry" is "30/60/90/120/180/240." Please select an appropriate drying time. If the drying time is too short, the clothes cannot be completely dried.

After making the selection, tap "○" to confirm the selection.

Before drying, please confirm the material of the clothes to see if they can be dried. Drying clothes of different materials together will affect the drying effect. It is recommended to dry them separately. At the beginning of drying, water automatically enters the drum to rinse the lint in the air duct, which is normal. Before drying, you need to confirm that the faucet is turned on and it must be cold water.

At the end of the drying process, the device will run at a certain rhythm for a period of time to shake out the laundry and reduce wrinkles. Excessive cotton clothes that stick to the drum wall after spinning may affect the drying effect. It is recommended to take them out of the drum first, shake them out, and then put them back into the drum; please dry them in batches, and do not exceed the maximum amount of such clothes each time.

The device can sense the weight of the clothes to be dried and automatically adjust the drying time and drying intensity. The drying time may be longer or shorter than the set time.

Cold Wash ❄️

This function uses cold water for washing, and can automatically adjust the washing intensity and water level to achieve energy-saving and environmentally friendly washing performance.

Before starting the program, turn the main knob to select this function and tap "○" to activate/deactivate.

PreWash 🪵

This function adds a prewash period before the main wash phase and is suitable for heavily soiled laundry.

Before starting the program, turn the main knob to select this function and tap "○" to activate/deactivate.

Steam 🌫️

This function generates steam to reduce or eliminate wrinkles and make clothing more comfortable.

Before starting the program, turn the main knob to select this function and tap "○" to activate/deactivate the Steam function.

Stain Removal 🧴

This function is used for washing special stains.

Before starting the program, turn the main knob to select this function, and tap "○" to enter the selection of different stain types. After selecting a stain, lightly tap "○" to confirm the selection, and tap it again to abandon the selection.

If the program is changed, the selected stain type will be automatically canceled.

FUNCTION SELECTION TABLE

Program	Temp.	Rinse	Spin	Cycle mode	Quicker	Auto Dose	Child Lock	Mute	Delay End	Anti Crease	Dry Level	Cold Wash	Prewash	Steam	Stain Removal
Eco 40-60	-	-	•	•	-	•	•	•	•	-	•	-	-	-	-
Cotton	•	•	•	•	•	•	•	•	•	•	•	•	•	•	•
Synthetics	•	•	•	•	•	•	•	•	•	•	•	•	•	•	•
Cotton Dry	-	-	-	-	-	•	•	•	•	•	•	-	-	-	-
Synthetics Dry	-	-	-	-	-	•	•	•	•	•	•	-	-	-	-
Auto	•	•	•	•	-	•	•	•	•	•	•	-	•	-	-
Refresh	-	-	-	-	-	-	•	•	•	•	•	-	-	-	-
Baby Care	•	•	•	•	•	•	•	•	•	•	•	-	•	◦	-
Allergy Care	-	•	•	•	-	•	•	•	•	•	•	-	•	◦	-
Pets	•	•	•	•	-	•	•	•	•	•	•	•	•	•	-
Full load 49'	•	•	•	-	-	•	•	•	•	•	-	-	•	-	-
Power 30'	•	•	•	•	-	•	•	•	•	•	•	-	•	-	-
Quick 15'	•	•	•	•	-	•	•	•	•	•	-	-	-	-	-
Wash & Dry 49'	-	-	-	•	-	•	•	•	•	•	-	-	-	-	-
Bedding	•	•	•	•	-	•	•	•	•	•	•	•	•	-	-
Wool	•	•	•	-	-	-	•	•	•	-	-	-	-	-	-
Rinse+Spin	-	•	•	•	-	•	•	•	•	•	•	-	-	-	-
Drum Clean	-	-	-	-	-	-	•	•	•	-	◦	-	-	-	-
Spin	-	-	•	•	-	-	•	•	•	•	•	-	-	-	-

• Function optional

- Function not optional

◦ Function default and cannot be canceled

■ Press and hold  to enter the system function settings interface:
Users can select WLAN, APP and Pairing, Language, User Program, Drum Clean Reminder, Drum Light, System and other system function settings as needed, turn the main knob to select the function option, and tap "○" to confirm the selection. The corresponding icon is lit to indicate that this function is enabled.

WLAN

Turn the main knob to select this option, tap "○" to turn on/off the appliance's WLAN function, and long press "○" to set the appliance to connect to the WLAN network.

Network configuration steps:

1. Turn on the power, long press , and turn the main knob to select "WLAN".
2. Long press "○" to start network configuration, and the screen displays "Connecting".
3. Next, follow the prompts on the APP. After the connection is successful, the screen displays the network configuration success interface.
4. If it fails, you can repeat the operation from the first step.

APP and Pairing

This function needs to be used when the "WLAN" function is turned on and the connection is normal. Turn the main knob to select this option, and tap "○" to enter the "User adding" and "Unpair" setting interface.

After the appliance is successfully connected to the network and paired, the appliance can be remotely controlled through the App on the mobile phone.

Language

Turn the main knob to select this option and tap "○" to enter the "Language" settings interface. After turning the main knob to select the language, tap "○" to confirm the selection.

User Program

Users can set the program to be displayed on the home page.

Turn the main knob to select this option and tap "○" to enter the "User Program" settings interface.

Turn the main knob to select a program, tap "○" to cancel the selection, and tap it again to confirm the selection.

The "Drum Clean" and "Eco40-60" programs cannot be removed from the home page.

Drum Clean Reminder

This option allows you to set the drum clean reminder cycle.

Turn the main knob to select this option and tap "○" to enter the "Drum Clean Reminder" settings interface.

Turn the main knob to select the reminder cycle and tap "○" to confirm the selection.

Drum Light

This option allows you to manually turn on/off the Drum Light.

After the Drum Light is turned on, the Drum Light will automatically light up when the machine is turned on, the program is paused, the program ends, or when the program is running by rotating the main knob or touching an effective button.

Standard Dosage Amount

This option allows you to set the standard dispensing amount for Dispenser 1/Dispenser 2. When this option is enabled, you can adjust the amount of detergent/softener as needed.

Turn the main knob to select this option and tap "○" to enter the "Standard Dosage Amount" settings interface.

Turn the main knob to select Dispenser 1/Dispenser 2, and tap "○" to confirm.

The default dosage for detergent is 50ml (suitable for 4-5kg of laundry), and the default dosage for softener is also 50ml (suitable for 4-5kg of laundry), with an adjustable range of dosage from 10 to 100ml.

Dispenser 2



This option allows you to set the dispensing choice for "Dispenser 2". You can choose this compartment to dispense Softener/Detergent according to your needs.

Turn the main knob to select this option, tap "○" to enter the "Dispenser 2" settings interface.

Turn the main knob to select Softener/Detergent, and tap "○" to confirm. Operate according to the on-screen prompts. After making your selection, please be sure to add according to the settings.

"Dispenser 2" defaults to dispensing Softener. If the Softener is insufficient, a red  icon will be displayed on the screen as an alert.

Please follow the on-screen prompts when setting the dispensing of "Detergent".

1. If the same detergent is selected, the detergent in "Dispenser 2" will be dispensed first by default. If it is insufficient, the detergent in "Dispenser 1" will be dispensed. If both are insufficient, a red low detergent icon "" will be displayed on the screen as an alert.
2. If a different detergent is selected, the detergent in "Dispenser 2" will be dispensed by default and the icon "" lights up. If there is insufficient detergent in this compartment, the red icon 2 "" will be displayed on the screen as an alert.

When changing to a different Softener/Detergent, please empty the compartment first and activate the "Pump Clean" function to clean the residue in the compartment before changing to avoid affecting the washing performance.

Pump Clean

This option cleans the residue in the compartment and ensures an optimal washing performance.



Turn the main knob to select this option and tap "○" to enter the "Pump Clean" settings interface.

Turn the main knob to select Dispenser 1/Dispenser 2, and tap "○" to confirm. Open the detergent dispenser drawer, empty the corresponding compartment and fill it with clean water. Do not exceed the MAX scale mark for the clear water filling amount. Please close the detergent dispenser drawer completely after adding water. Operate according to the on-screen prompts and activate "Pump Clean".

-Before activating this function, be sure to empty the compartment, otherwise bubbles will form in the drum.

System

This option allows you to enter the settings interfaces such as "System Update," "Reset," "Demo," "Operating Tips," "Software Licenses," etc.

-After enabling "Demo" mode, the program is unable to start. To exit the "Demo" mode, press and hold  to enter the system settings, turn the main knob to select "System", tap "○", turn the main knob to select "Demo", and tap "○" to turn it off.

SMART NETWORKING

Enter the "Settings" interface on your smartphone or tablet, enable Bluetooth and wireless connections, and connect to a wireless network.

NOTE:

This appliance supports 2.4 GHz Wi-Fi.

When the Wi-Fi function is enabled, the power consumption of the appliance increases. However, the Wi-Fi power is less than 2W, so it does not affect the energy efficiency rating of the appliance.

Download

Search ConnectLife from the APP store on your smartphone or tablet (Google Play Store, Apple App Store), and download and install the APP.

NOTE:

To improve performance and experience, the APP may update without notice.

Login

You need to log in to ConnectLife with your account. If you do not have a ConnectLife account, you will need to create a new one. For details, please refer to the APP's user instructions.





NOTE:

If you already have a Google account, you can log in directly using your Google account.



Device binding

1. Open ConnectLife on your smartphone or tablet.
2. Bind your appliance in ConnectLife as follows:
 - A. Click the "+" on the "Home" interface, then select "Add device" or "Scan".
 - B. Choose "Washing Machine" or click "Scan QR/BAR code" or "Manual entry".
 - C. Scan the "QR/BAR code" on the appliance or manually enter the device "AUID/SN". If you cannot find it, click "?" for instructions.
 - D. Read the instructions and operate the appliance until it switches to "Networking" or "Binding" status, then click "NEXT".
 - E. The APP starts searching for the appliance. You can select the desired appliance from the search list. If not found, please check if your Bluetooth is activated. Keep Bluetooth in active mode, then click "NEXT".
 - F. Select your home Wi-Fi, enter the password and click "CONNECT". The appliance starts the connecting and binding process.
 - G. After successful binding, you can set the name of the appliance and the room in which it is located.
 - H. The appliance can now be controlled remotely via the APP.

Unpair

1. Unpair on the appliance:
 - A. Check and make sure the "WLAN" function is turned on and connected normally.
 - B. Press and hold  to enter the system function settings interface.
 - C. Turn the main knob to select "APP and Pairing" and tap  to confirm the selection.
 - D. Turn the main knob to select "Unpair" and tap  to confirm the selection.
 - E. Select "SURE" and tap  to unpair all bindings.
2. Unpair on the smart device:
 - A. Select and tap the appliance you want to unpair on the "Devices" page.
 - B. Tap "Settings" to enter the settings page.
 - C. Tap "Remove Device" to unpair the appliance on the ConnectLife app.

Data Delete

Press and hold  to enter the system settings. Turn the main knob to select "System" and tap . Turn the main knob to select "Reset" and tap . Follow the prompts displayed on the screen to reset the system. After the system reset, the data stored on the user's device will be deleted.

START THE PROGRAM

Select the program and function parameters, and confirm that the detergent has been added to the detergent box, and tap the **Start**/Pause button to start the program.

END OF THE PROGRAM

When the program ends, the appliance will sound a prompt and the display will show the end interface. The end interface shows the power consumption, running time, water consumption and number of rinses of this program (if the drying function or Anti Crease function is added, the display interface will be different after the program ends). You can press the power button to shut down. If you do not perform any operation for a period of time, the appliance will automatically turn off the screen. If you do not perform any operation for a period of time after the screen is turned off, the appliance will automatically shut down.

 After the program ends, please turn off the power of the appliance, turn off the tap, unplug the power cord from the socket, open the door and remove the laundry from the drum.

 Some programs automatically detect the weight of the laundry before washing, and the program duration will be automatically adjusted.

INTERRUPTIONS AND CHANGING THE PROGRAM

INTERRUPTION THE PROGRAM

To stop or cancel the program during operation, you must switch off the appliance.

CHANGING THE PROGRAM

To change the program during operation, switch the appliance off and on again, select the desired program and extra functions, then press the **"Start/Pause"** button to start the new program.

PAUSE THE PROGRAM

The program can be paused at any time during program operation by pressing the **"Start/Pause"** button. When the program is paused/flashing for the rest of the time on the display, the program is paused. If the following conditions are met, the door lock will be automatically unlocked and the door can be opened.

1. The temperature in the drum must be lower than the set safety value;
2. The water level in the drum must be lower than the set safety value.

To resume the program, please close the door first, and then press the **"Start/Pause"** button. The washing/drying program is paused, and when it is restarted, the program will continue to run from where it was interrupted. The spin program is paused, and when it is restarted, the program will start from the beginning of the spin cycle.

ADD CLOTHES

If you need to add clothes during program operation, press the **"Start/Pause"** button, the program will be paused, and the program on the display will pause/flash for the rest of the time. If the safety conditions are met, the door lock will be automatically unlocked, and the door lock icon will go out (the **"Add Clothes"** icon "" will light up for some models), you can open the door to add clothes. If the door lock icon does not go out, the door opening conditions are not met and you cannot add clothes midway.

 If a significant amount of extra laundry is added during washing and the water level is insufficient, the cleaning effectiveness may decrease, as the appliance calculates water intake based on the initial weight of the laundry. Insufficient water may also cause damage to the laundry due to friction, and the washing time will be extended.

FAULT

In case of a fault, the program will be interrupted.

Flashing signal lights and an acoustic signal will warn about such occurrence (see chapter **FAULT CODES AND TROUBLESHOOTING**), and the fault code (FXX) will be indicated on the screen.

POWER SUPPLY FAILURE

In case of a power supply failure (power outage), the washing program is interrupted. When power supply is restored, the program is resumed from the point where it was interrupted.

 **If there is still water in the appliance after a power outage, do not open the door until you have manually drained the water using the pump filter.**

EMERGENCY DOOR OPENING

In case of failure to open the door due to power outage or other special circumstances, the door lock lever at the pump cover can be used for emergency opening.

 NOTE:

1. Do not use this function when the appliance is working normal
2. Before use, ensure that the inner drum has stopped spinning, the temperature is safe, and the water level is below the laundry inlet. If the water level exceeds the laundry inlet, drain off water through the drain hose (if fitted) or by slowly unscrewing the pump filter.
3. Operation method: Open the pump cover and use a tool to pull down the door lock lever. The door can then be opened (as shown in the figure). Return the door lock lever to its original position after opening the door.

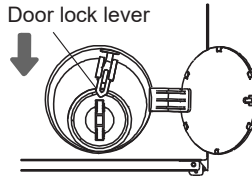

MAINTENANCE & CLEANING

 Regular maintenance can extend the appliance's service life. Before maintenance, please be sure to cut off the power supply and turn off the faucet.

 Children are not allowed to clean the appliance or perform any maintenance on it without supervision.

CLEAN THE DETERGENT DRAWER

 Please clean the detergent box regularly.

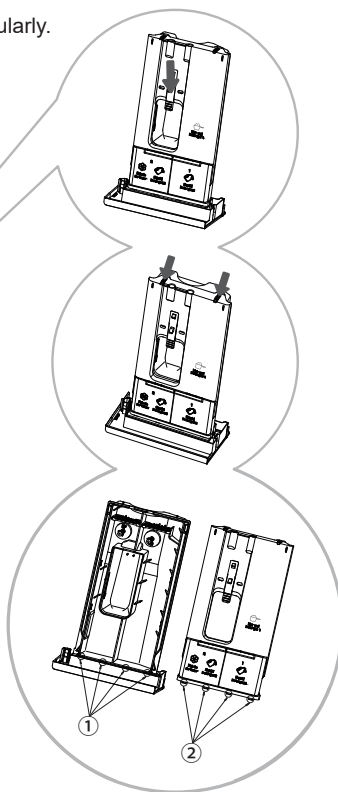
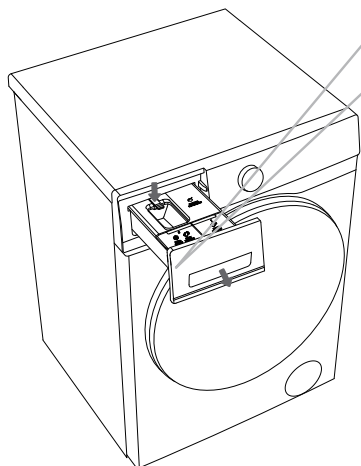



1 Open the detergent dispenser drawer, press the limit rod as shown in the figure, and pull out the detergent box.

2 Peel back the two bending ribs at the positions shown in the diagram, and pull upward to remove the box cover.

3 Empty the residual detergent and softener from the detergent box, clean the detergent and box lid with running water, and dry it off.

4 Insert the limiting rib ② of the cover into the corresponding slot ① of the detergent box, and press down on the cover until you hear a "click" sound, which means the bending ribs at the back of the cover are secured. Put the detergent box back in its original place.

 Push the automatic dispensing detergent box all the way in. Otherwise, the appliance will not be able to draw detergent/softener from the detergent box during operation. If the automatic dispensing detergent box is not completely closed, the appliance will not function properly and water may leak through the detergent box handle.

 When cleaning the automatic dispensing detergent box, be sure to remove any detergent and softener residue, and clean the bottom of the container casing; otherwise, it may cause automatic dispensing abnormalities.

 Do not leave detergent or softener in the storage chamber for long periods of time as they may harden and cannot be dispensed automatically.

 Do not place the detergent box in the dishwasher for cleaning.

CLEAN THE WATER INLET HOSE, DETERGENT DRAWER OUTER COMPARTMENT, AND RUBBER DOOR GASKET

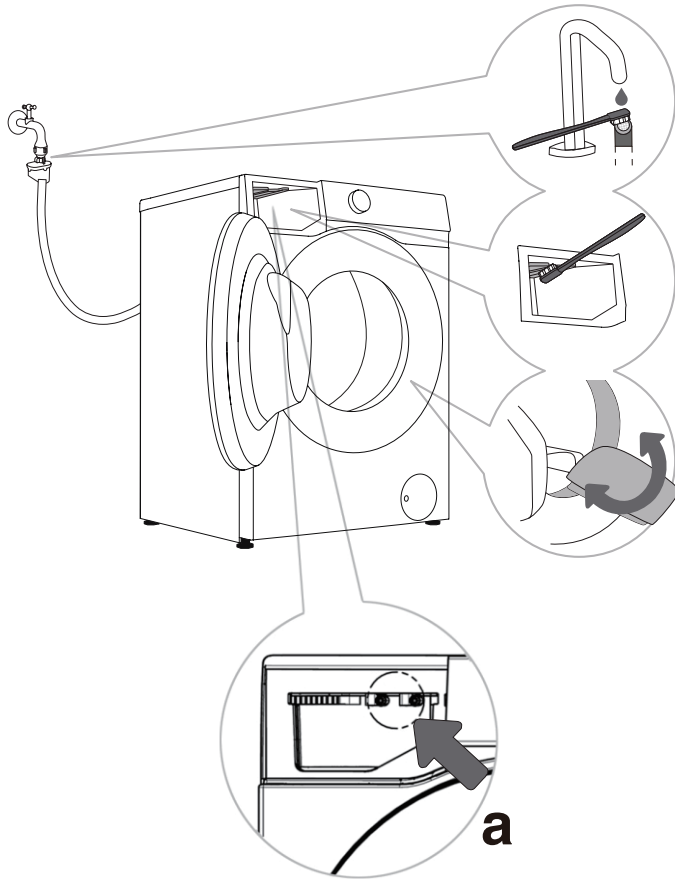

1 Clean the water inlet hose filter regularly.

2 Use a brush to clean the detergent drawer outer compartment, especially the nozzle on the upper side of the compartment.

3 After each wash, wipe the rubber door gasket to extend its life. After washing, keep the appliance door slightly open to release moisture before closing it, to prevent the door seal from getting moldy.

 When you suspect that the detergent/softener is not being dispensed, the following methods can be used to check:

1. Make sure the automatic dispensing setting for the detergent/softener is activated.
2. Pull out the automatic dispensing detergent box and check whether the bottom sealing ring is loose or damaged (Figure a). If it is loose or damaged, please contact after-sales service for repair or replacement.
3. Reinstall the automatic dispensing detergent box and determine whether it dispenses normally by following the steps below.
 - Pull out the detergent box and check if there is any detergent/softener visible in the compartment.
 - Check whether the detergent is dispensed normally: Select and run the Quick 15' program, press the pause button after running for about 2 minutes, and open the appliance door. Check whether the water in the drum contains foam and has a detergent smell.
 - Check whether the softener is being dispensed normally: Confirm that the dispensing setting for "Dispenser 2" is set to Softener. Select and run the Rinse+Spin program, press the pause button after running for about 15 minutes, and open the appliance door. Check whether the water in the drum contains foam and has a softener smell.
 - If the water in the drum contains foam and has a detergent/softener smell, the automatic dispensing function of the appliance is normal. Otherwise, please contact after-sales service for repair or replacement.

CLEANING THE PUMP FILTER

 Water may be spilled when cleaning the pump filter. It is therefore recommended to place an absorbent cloth on the floor.

Make sure the water has cooled down before you release it from the appliance.

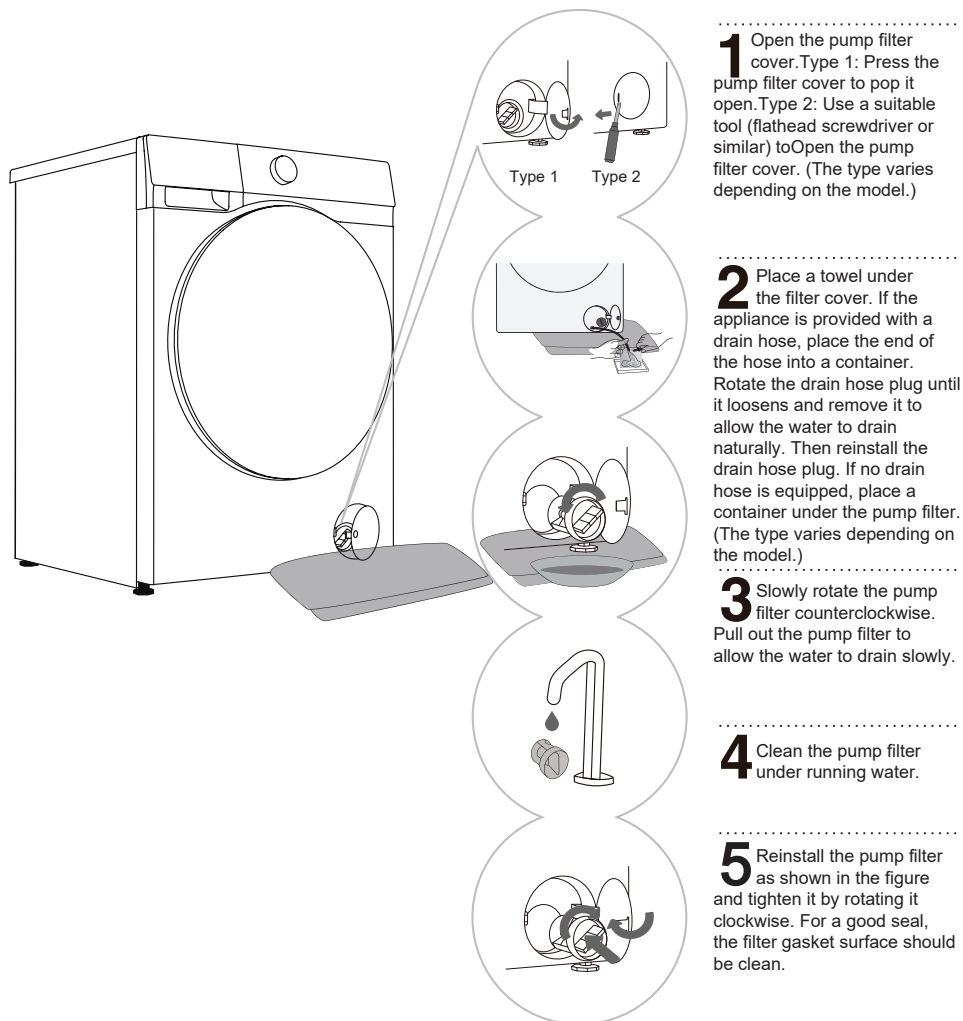

1 Open the pump filter cover. Type 1: Press the pump filter cover to pop it open. Type 2: Use a suitable tool (flathead screwdriver or similar) to open the pump filter cover. (The type varies depending on the model.)

2 Place a towel under the filter cover. If the appliance is provided with a drain hose, place the end of the hose into a container. Rotate the drain hose plug until it loosens and remove it to allow the water to drain naturally. Then reinstall the drain hose plug. If no drain hose is equipped, place a container under the pump filter. (The type varies depending on the model.)

3 Slowly rotate the pump filter counterclockwise. Pull out the pump filter to allow the water to drain slowly.

4 Clean the pump filter under running water.

5 Reinstall the pump filter as shown in the figure and tighten it by rotating it clockwise. For a good seal, the filter gasket surface should be clean.

 The pump filter must be timely cleaned, especially after washing very fleecy, woolly, or very old laundry.

 Also clean the pump filter if the appliance cannot start the spinning cycle or when there is debris in the pump (buttons, coins, hair pins or clips etc.).

 Do not open the pump filter while the appliance is running. Do not operate the appliance until the pump filter is securely installed to avoid leaks or malfunctions.

CLEANING THE INLET FILTER

Check and clean the inlet filter regularly.
Clean the inlet filter immediately if water supply is slow.
Operation procedures are as follows:

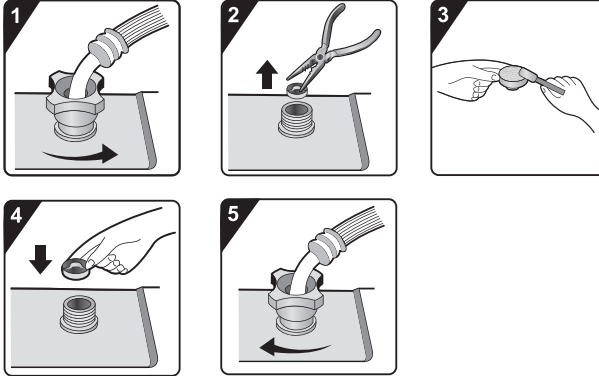

1 Close the water tap and unscrew the water supply hose.

2 Remove the inlet filter.

3 Clean the inlet filter.

4 Reinstall the inlet filter.

5 Connect the water supply hose. Open the water tap and ensure there are no leaks at the connection.

 The inlet filter collects impurities and sediment from the water supply. It is recommended to clean it at least every six months, or more frequently if you have hard water or notice scale buildup.

CLEANING THE EXTERIOR

 **Always disconnect the appliance from the power mains before cleaning.**

Clean the appliance exterior and display unit using a soft, damp cotton cloth and water. Then, use a soft, dry cloth to wipe the appliance dry.

 Do not use any solvents or cleaning agents that could damage the appliance (please observe the recommendations and warnings provided by the cleaning agent manufacturers).

Clean the appliance door with a damp cloth, and then wipe it dry with a soft, dry cloth.

 Do not use excessive water to clean the appliance.

TROUBLESHOOTING

The appliance is equipped with a number of automatic safety features to detect faults and take effective safety measures in a timely manner.

These faults are usually minor and can be rectified quickly.

If the appliance cannot operate normally, a fault message will appear on the screen. Please refer to the warning message for the appropriate action.

If the recommended troubleshooting methods do not resolve the problem, please contact after-sales service.

The user will assume all liability for any consequences arising from repairs carried out by themselves or unauthorised personnel.

Fault phenomenon	Recommended countermeasures
<p>Machine fails to start</p>	<ul style="list-style-type: none"> ◇ Check whether the power cord is plugged into the socket and whether the socket is working functionally (by testing it with another appliance). ◇ Check whether the door is properly closed. ◇ Check whether the "Start/Pause" button is pressed. <p>Machine stops during normal operation</p> <ul style="list-style-type: none"> ◇ Check whether door is properly closed. Close the door and press the "Start/Pause" button. ◇ Check for excessive foam. The appliance may pause the program for defoaming. After the defoaming process, the appliance will automatically resume operation. ◇ Check whether the safety protection has been activated.
<p>Time displayed at the start of the program increases or decreases</p>	<p>This is the adaptive adjustment of the appliance to the factors that influence the washing time.</p> <ul style="list-style-type: none"> ◇ Excessive foam. ◇ Unbalance caused by large laundry. ◇ Extended heating time due to low water intake temperature. <p>As a result of these factors, the remaining time displayed is recalculated and updated accordingly (if the appliance is making an unbalance adjustment, the time displayed remains unchanged). In addition, the appliance detects the load during the water supply and adjusts the program time accordingly (fuzzy control).</p>
<p>Residual detergent or other additives in the detergent drawer after washing</p>	<ul style="list-style-type: none"> ◇ Check whether the detergent drawer is correctly installed and kept clean. ◇ Check whether the water pressure is normal and whether the inlet filter is clogged (see chapter "MAINTENANCE AND CLEANING").
<p>Odour in the machine</p>	<ul style="list-style-type: none"> ◇ The odour may be caused by the rubber materials inside the appliance. It is the rubber smell, which dissipates after a few uses.



The warranty does not cover the faults or failures resulting from external factors (lightning strike, power grid failures, natural disasters etc.).

Fault phenomenon	Recommended countermeasures
Abnormal sound/noise during washing	<ul style="list-style-type: none"> ◇ Foreign objects such as keys, coins or pins may have fallen into the drum. Stop the appliance and check for foreign objects in the drum. If noise persists after restarting, please contact after-sales service. ◇ Laundry may be unevenly distributed in the drum. Pause the program, unlock the door, and redistribute the laundry.
Intense vibrations during spinning	<ul style="list-style-type: none"> ◇ Check whether the appliance is level and whether all four feet are firmly seated on the floor. ◇ Check whether the transport screw/rods have been removed. Transport screw/rods must be removed before using the appliance. ◇ Check whether all foam supports have been removed from the bottom of the appliance.
Poor spinning effect	<p>The appliance is equipped with a balance detection and correction system. After detecting unbalance caused by heavy laundry (e.g., bathrobes) and several spinning attempts, the system automatically reduces the spinning rate or even stops the spinning process to protect the appliance.</p> <ul style="list-style-type: none"> ◇ If the laundry is still very wet after spinning, take the laundry out of the drum, shake it loose, and then select the spinning program again. ◇ Excessive foam may impair the spinning effect. Make sure to use an appropriate amount of low-foaming detergent. ◇ Check whether the spinning rate is set to "0" or "No Spin".
Water leakage	<ul style="list-style-type: none"> ◇ Leak from the water supply hose. Check the connection between the tap and the water supply hose connector for leaks. If there is a leak, wrap sealing tape around the end of the tap or replace the tap. It is recommended to check the connection between the water supply hose connector and the inlet valve for tightness. Tighten the connection to eliminate leaks. ◇ Leak from the drain hose. For top-drain models, the drain hose clips must not be removed as this will result in a continuous water discharge. ◇ Leak from the detergent drawer. The detergent drawer is not closed tightly. Push the handle to close the detergent drawer tightly. ◇ Leak from the door seal. Check the door seal for foreign objects and clean if necessary.
Wrinkled laundry	<ul style="list-style-type: none"> ◇ The laundry is not removed promptly from the drum. After the wash cycle is completed, remove the laundry from the drum promptly. ◇ The appliance is overloaded. The drum should not be full of laundry and the door should be easy to close. ◇ The spinning rate is too high. Set a suitable spinning rate for the type of laundry.

DRY FAULT (FOR TUMBLE DRYER MODELS)

Fault phenomenon	Recommended countermeasures
<p>appliance does not carry out drying process</p>	<ul style="list-style-type: none"> ◇ Check whether the drying program is set up. ◇ Check whether the water tap is unopened. ◇ Check whether the door is properly closed. ◇ Check whether the load is excessive (see PROGRAM TABLE for capacity requirements), and take out part of the laundry to dry again.
<p>Poor drying effect</p>	<ul style="list-style-type: none"> ◇ Check whether the load is excessive. If so, it will cause unsatisfactory drying effect and increased wrinkling. Separate the laundry in the drum for individual drying. ◇ Check if heavier items (e.g., thick cotton) are mixed with lighter ones (e.g., synthetic fabrics). ◇ Dry laundry separately by type.
<p>Excessive drying time</p>	<ul style="list-style-type: none"> ◇ Check whether the load is excessive (see PROGRAM TABLE for capacity requirements), and take out part of the laundry to dry again. ◇ Laundry is not sufficiently spun (see section "Poor spinning effect" for guidance). ◇ A large amount of thicker laundry (e.g., jeans).
<p>Odour during drying</p>	<ul style="list-style-type: none"> ◇ Using detergents or softeners with strong chemical odours may cause odours during drying. ◇ If the appliance is not thoroughly cleaned, residual dirt may produce odours while drying. Clean the appliance regularly (see chapter "MAINTENANCE AND CLEANING") and promptly remove laundry after drying.

FAULT CODES AND TROUBLESHOOTING

If the unit is not operating normally and the following codes are displayed, this may not indicate a fault. Please refer to the FAULT CODES for appropriate action.

Problem/Fault	Description	What to do?
F01	Water inflow fault	<p>Check the following:</p> <ol style="list-style-type: none"> 1. Is the water tap is open? Is the pressure too low? 2. Is the water supply hose pinched? 3. Is the Inlet filter clogged? 4. Is the water supply hose frozen? <p>After troubleshooting is finished, press the "Start/Pause" button to continue operation.</p>
F03	Water discharge fault	<p>Check the following:</p> <ol style="list-style-type: none"> 1. Is the drain hose pinched? Does the water flow through the hose? 2. Is the filter on the drain hose clogged? 3. Is the drain hose frozen? <p>After troubleshooting is finished, press the "Start/Pause" button to continue operation.</p>
F24	Overflow	<p>Pause and restart the program.</p> <p>If the appliance continues to overflow, close the water tap and contact a service technician.</p>
F13	Door locking fault	<p>Door is closed, but it cannot be locked.</p> <p>Switch the appliance off and on again. Then restart the washing program.</p> <p>If the fault persists, contact a service technician.</p>
F14	Door unlocking fault	<p>Door is closed, but it cannot be unlocked.</p> <p>Switch the appliance off and then back on. If the fault persists, contact a service technician.</p>
Other	Electronic module fault	<p>Switch the appliance off and then back on.</p> <p>Restart the washing program.</p> <p>If the fault persists, contact a service technician.</p>
Unb	Unbalance alarm	<p>Unbalance alarm shall be solved by the following methods:</p> <ol style="list-style-type: none"> 1. Laundry tangling If the laundry is tangled, first switch off the appliance, open the door, shake the laundry loose and put it back in the drum. Then close the door and select the spinning program again. 2. Underweighted laundry Switch off the appliance, open the door and load additional laundry (or one or two towels). Then close the door and select the spin program again.
F15-F18	Abnormal drying (for tumble dryer models)	<p>Switch the appliance off and then back on.</p>

SERVICING

BEFORE CALLING A SERVICE TECHNICIAN

When you contact the service centre, please specify your appliance model.

The model, code / ID, type and serial number are indicated on the nameplate of the appliance.

 In case of a defect, only use spare parts approved by authorised manufacturers.

 Repairs or warranty claims due to incorrect connections or misuse of the appliance are not covered by the warranty. In such cases, the cost of repair shall be borne by the user.

USAGE RECOMMENDATIONS

When washing colored clothes for the first time, wash them separately by color.

Wash heavily soiled laundry in smaller amounts, with increased powder detergent or a Prewash cycle (if available). Apply a special-purpose stain remover on stubborn stains before the wash. We recommend referring to "stain removal tips".

If you often wash laundry at low temperatures and with liquid detergents, bacteria may develop and cause odour in the appliance. To prevent such odour, we recommend running "Drum Clean" (or other high-temperature programs) from time to time.

We recommend avoiding washing very small amounts of laundry as this will lead to excessive use of energy and poor appliance performance.

Loosen any folded or tangled laundry before putting it into the drum.

Only use detergents for appliance.

If water hardness exceeds 14°dH, water softener should be used. Heater damage resulting from incorrect use of water softeners shall not be covered by the warranty. Check the information on water hardness with your local water supply company or authority.

Use of chlorine-based bleaches is not recommended as they can damage the heater.

If you use a descaling agent, bleach, or dye, only use the kind that is suitable for use in the appliance.

Do not use solvents or similar chemicals (e.g., paint thinner, turpentine, gasoline).

Do not add hardened lumps of powder detergent into the detergent dispenser as this may clog the piping in the appliance.

Powder or liquid detergent should be added according to the manufacturer's instructions, washing temperature, and selected program.

When using concentrated liquid laundry care products, we recommend diluting them with water to prevent clogging the detergent drawer drain.

Liquid detergent is suitable for washing program without a prewash cycle.

Exercise caution to avoid mixing detergent and softener.

At higher spinning rates, there will be less residual moisture in the laundry. As a result, drying in a tumble dryer will be more economical and faster.

STAIN REMOVAL TIPS

Before using special-purpose stain removers, try using the natural methods that do not harm the environment on less stubborn stains. However, timely treatment makes stain removal easier! Remove stains by rinsing with cold (lukewarm) water - but never with hot water!

Stains	Stain removal
Mud	When the stain is dry, first scrape it off the laundry before washing it in the appliance. If the stain is stubborn, soak it with an enzyme-based stain remover before the wash. If the stain is not stubborn, wash the laundry with liquid or powder detergent and water before the wash.
Antiperspirant	Before washing in the appliance, apply liquid detergent onto the laundry. Apply stain removers on any stubborn stains. Alternatively, use oxygen-based bleach for the wash.
Tea	Soak or rinse the laundry in cold water and add stain remover if necessary.
Chocolate	Soak or rinse the laundry with lukewarm soapy water. Then, apply lemon juice and rinse.
Ink	Before washing in the appliance, apply stain remover on the stain. You may also use denatured alcohol. Turn the laundry inside out and place a paper towel under the stain. Use the alcohol on the back side of the stain. At the end of the process, thoroughly rinse the laundry.
Felt tip pens	Dilute some starch in water and apply it to the stain. When it dries, scrape it off with a brush. Then, put the laundry into the appliance to wash.
Baby (urine, mud, food stains)	Before washing in the appliance, soak the stains in lukewarm water for at least half an hour. For easier stain removal, add an enzyme-based stain remover.
Grass	Before washing in the appliance, soak the laundry in an enzyme-based stain remover. Grass stains can also be removed by soaking (for approx. 1 hour) in diluted lemon juice or distilled vinegar.
Egg	Soak the laundry in an enzyme-based stain remover. Soak in cold water for at least 30 minutes, or a few hours if the stains are stubborn. Then, wash in the appliance.
Coffee	Soak the laundry in salt water. If the stain is not fresh, soak it with a mixture of glycerine, ammonia and alcohol.
Shoe polish	Apply cooking oil to the stain and rinse.
Blood	Fresh stain - Rinse the laundry with cool water and wash it in the appliance. Dried stain - Soak the laundry in an enzyme-based stain remover. Then, wash in the appliance. If the stain does not vanish, try to remove it with a bleach suitable for your laundry.

Stains	Stain removal
Glue, chewing gum	Place the laundry in a bag and put it in the freezer until the stain hardens. Then remove it with a blunt knife. Dilute the stain with a prewash stain remover and rinse thoroughly. Finally, wash the laundry in the appliance.
Makeup	Use a stain remover for the prewash, then wash in the appliance.
Butter	Before washing in the appliance, apply stain remover onto the laundry. Then, rinse with hot water (as hot as the fabric allows).
Milk	Soak the laundry in an enzyme-based stain remover. Soak for at least 30 minutes, or a few hours if the stains are stubborn. Then, wash in the appliance.
Fruit juice	Apply a mixture of salt and water on the stain. Leave to take effect for a while, then rinse. You can apply sodium bicarbonate, distilled vinegar or lemon juice on the stain before washing in the appliance. For old stains, use glycerine. After 20 minutes, rinse with cold water. Finally, wash the laundry in the appliance.
Wine	Soak the laundry in cold water for at least 30 minutes. Also, use a stain remover. Then, wash in the appliance.
Wax	Put the laundry into the freezer until the wax hardens. Then, scrape it off. Remove the remaining wax by placing a paper towel onto the stain, and then heat it with an iron until the paper absorbs the wax.
Sweat	Before washing in the appliance, rub liquid detergent thoroughly into the stain.
Chewing gum	Put the laundry into the freezer until the chewing gum hardens. Then, wash in the appliance.

DISPOSAL



Packaging is made of environmentally friendly materials that can be recycled, disposed of, or destroyed without any hazard to the environment. To this end, packaging materials are labelled appropriately.

The symbol on the product or its packaging indicates that the product should not be treated as normal household waste. Take the product to an authorised collection centre for waste electric and electronic equipment processing.

When disposing of the appliance at the end of its useful life, remove all power cords, and destroy the door latch and switch to prevent the door from locking or latching, and to prevent children or small animals from becoming trapped inside and causing a hazard.

This appliance is marked according to the European directive on waste (WEEE).

Correct disposal of the product will help prevent any negative effects on the environment and health of people, which could occur in case of incorrect product removal. For detailed information on removal and processing of the product, please contact the relevant municipal authority in charge of waste management, your household waste disposal service, or the store where you bought the product.





TYPICAL CONSUMPTION TABLE

Programme Instructions

1. The Eco 40-60 programme is able to clean normally soiled cotton laundry declared to be washable about 40°C to 60°C together in the same cycle, and that this programme is used to assess the compliance with the EU ecodesign legislation.
2. The power consumption of the off-mode is 0.49W.
3. The most efficient programmes in terms of energy consumption are generally those that perform at lower temperatures and longer duration.
4. Loading the household washer dryer up to the capacity indicated by the manufacturer for the respective programmes will contribute to energy and water savings.
5. Correct use of detergent, softeners and other additives. Do not apply excessive detergent. This may affect the washing results adversely.
6. Periodic cleaning, including optimal frequency, and limescale prevention and procedure.
7. Noise and remaining moisture content are influenced by the spinning speed: the higher the spinning speed in the spinning phase the higher the noise and the lower the remaining moisture content.
8. The product information and QR code are reflected in the energy consumption label the product registration information can be obtained by scanning the QR code.
9. The information of standard programmes.

Program	Selected Temperature (°C)	Rated Capacity (kg)	Maximum temperature in drum (°C)	Program duration (h:min)	Energy consumption (kWh/cycle)	Water consumption (litres/cycle)	Remaining moisture content (%)	Maximum speed reached (rpm)
Eco40-60 full load	-	12.0	30	3:59	0.608	67.0	53.90	1400
Eco40-60 half load	-	6.0	29	3:00	0.420	49.0	53.90	1400
Eco40-60 1/4 load	-	3.0	24	2:58	0.170	35.0	53.90	1400
Wash and Dry full load	-	8.0	28	9:59	4.460	110.0	-	-
Wash and Dry half load	-	4.0	24	7:24	2.570	70.0	-	-
Cotton	20	12.0	20	2:09	0.380	145.0	55.00	1400
Cotton	60	12.0	56	3:38	2.500	145.0	55.00	1400
Synthetics	40	6.0	40	2:35	1.250	115.0	35.00	1400
Quick 15'	20	2.0	20	0:15	0.065	35.0	75.00	800

The values given for programs other than the Eco 40-60 program and the wash and dry cycle are indicative only.

The entry mode of wash and dry cycle is : Eco 40-60 +  +  + Dry level +  + Eco + .

 Maximum or nominal load applies to laundry prepared pursuant to the IEC 60456 standard.

 **Due to deviations in terms of type and amount of laundry, spinning, power supply oscillation, and environment temperature and humidity, the programme duration and power consumption values measured at the end user may differ from the ones stated in the table.**

We reserve the right to any changes and errors in the instructions for use.

Hisense
life reimagined