



USER GUIDE

BELLING 90cm ELECTRIC INDUCTION MODELS

Table Of Contents

INTRODUCTION	3
MODELS COVERED BY THIS DOCUMENT	3
COUNTRIES OF DESTINATION:	3
CONTACT INFORMATION:	3
EUROPEAN DIRECTIVES	4
DISPOSAL OF PACKAGING MATERIAL	4
SAFETY & WARNING INFORMATION	5
ELECTROMAGNETIC INTERFERENCE	12
GETTING TO KNOW YOUR PRODUCT	13
COMPARTMENT OVERVIEW	13
CONTROL PANEL	14
HOB OVERVIEW	14
INDUCTION HOB CONTROLS (Touch models)	16
ABOUT THE INDUCTION HOB (TOUCH CONTROLS)	17
INDUCTION SYMBOLS AND CODES	22
MAXIMUM OPERATING TIMES FOR INDUCTION HOB ZONES	24
GRILL CONTROL DIAL	24
MAIN OVEN OVERVIEW	24
TALL OVEN OVERVIEW	26
USING THE GRILL	28
GRILL PAN AND TRIVET	29
USING THE MAIN OVEN	30
MAIN OVEN FUNCTIONS	33
OVEN FURNITURE	34
USING THE PROGRAMMABLE TIMER	36
CLEANING YOUR APPLIANCE	41
CLEANING AND CARE GUIDANCE	42
APPLIANCE MAINTENANCE	46
CHANGING THE LIGHTBULB	46
OVEN SHELVES	46
REMOVING AND REPLACING SHELF GUIDES	47
REMOVING AND RE-FITTING CONTROL KNOBS, SPRINGS AND BEZELS	48
FAQs	50
KEY PARTS AND OPTIONAL ACCESSORIES	51
LOCATING THE MODEL AND SERIAL NUMBERS	54
TECHNICAL DATA	55
ENERGY DATA TABLE	56
ENERGY SAVING TIPS FOR HOBS	57
ENERGY SAVING TIPS FOR OVENS	58
SERVICE CONTACT DETAILS	59

INTRODUCTION

Congratulations and thank you for purchasing your new cooking appliance. We hope you will enjoy many years of excellent cooking performance and service.

This user guide is designed to help you care for and get the best out of your new appliance.

Please read it carefully before you start using your appliance, as we have endeavoured to answer as many questions as possible and provide you with as much support as we can.

General information, spares and service information is available from our website.

If you should find something missing from your product or have any questions that are not covered in this user guide, please contact us (see contact information on the back cover).

MODELS COVERED BY THIS DOCUMENT

Model Number:	Model Description:
444411795	BEL RCA COOKCENTRE 90Ei BLK
444411796	BEL RCA COOKCENTRE 90Ei STA
444411822	BEL RCA FARMHOUSE 90Ei ANT
444411823	BEL RCA FARMHOUSE 90Ei BLK
444411824	BEL RCA FARMHOUSE 90Ei CRM

COUNTRIES OF DESTINATION:

GB - United Kingdom	✓
IE - Ireland	✓
BE - Belgium	
DE - Germany	
FR - France	
NL - Netherlands	
PL - Poland	
SE - Sweden	
AU - Australia	
NZ - New Zealand	

CONTACT INFORMATION:

Customer Care Helpline:

0344 815 3746

Alternatively, use the contact form on our website

www.belling.co.uk

Details about warranty registration and spares & service information are also available on our website.

Calls are charged at the basic rate, please check with your telephone service provider for exact charges.

Your new appliance comes with our FREE 3 year warranty (UK only), protecting you against electrical and mechanical breakdown.

3 YEAR WARRANTY

PARTS AND LABOUR

To register your new appliance for its warranty (UK only) please visit our website www.belling.co.uk. For full terms & conditions of the manufacturer's guarantee, please refer to the website above.

In addition, you may wish to purchase an extended warranty. Details of how to do this are also on our website www.belling.co.uk.

Our policy is one of constant development and improvement, therefore we cannot guarantee the strict accuracy of all of our illustrations and specifications. Changes may have been made subsequent to publishing.

Glen Dimplex Home Appliances, Element, Temple Court, Risley, Warrington, WA3 6GD.

EUROPEAN DIRECTIVES

This appliance is produced in accordance with all applicable local and international standards and regulations.

As a producer and a supplier of cooking appliances we are committed to the protection of the environment and are in compliance with the WEEE directive.

All our electric products are labelled accordingly with the crossed out wheeled bin symbol. This indicates, for disposal purposes at the end of their working life, that these

products must be taken to a recognized collection point, such as local authority sites/ local recycling centres.



By ensuring that this product is disposed of correctly, you will help prevent potential negative consequences for the environment and human health, which could otherwise be caused by inappropriate waste handling of this product.

For more detailed information about recycling of this product, please contact your local authority, household waste disposal service, or the retailer from whom you purchased this appliance.

This appliance complies with European Community Directives (CE) for household and similar electrical appliances and Gas appliances where applicable.

This appliance conforms to European Directive regarding Eco design requirements for energy-related products. Our policy is one of constant development and improvement, therefore we cannot guarantee the strict accuracy of all of our illustrations and specifications - changes may have been made subsequent to publishing.

DISPOSAL OF PACKAGING MATERIAL

Some of the materials used to package this appliance can be recycled. Please dispose of the packaging materials in the appropriate containers at your local waste disposal facility.

SAFETY & WARNING INFORMATION

Please read the following information carefully:

WARNINGS



Warning

We strongly recommend that this appliance is connected by a competent person who is a member of a 'Competent Person Scheme', who will comply with the required regulations.

Any servicing, maintenance or repair work on the appliance must only be carried out by authorised personnel.

Installation, maintenance and repair work that is carried out by unauthorised persons could be dangerous and could invalidate the manufacturer's warranty.



Warning

This appliance can be used by children aged from 8 years and above and persons with reduced physical, sensory or mental capabilities or lack of experience and knowledge if they have been given supervision or instruction concerning use of the appliance in a safe way and understand the hazards involved.

Children shall not play with the appliance.

Cleaning and user maintenance shall not be made by children without supervision.

Young children should be supervised to ensure they do not play with this appliance.

Do not store items of interest to children in cabinets above the appliance. Children climbing on the appliance could be seriously injured.



Warning

If the hotplate surface is cracked, switch off the appliance and do not use it to avoid the possibility of electric shock.

**Warning**

During use the appliance becomes hot. Care should be taken to avoid touching heating elements inside the oven.

**Warning**

Metallic objects such as knives, forks, spoons and lids should not be placed on the hob surface since they can get hot.

Any spillage should be removed from the lid before opening and the hob surface should be allowed to cool before closing the lid (if fitted).

**Warning**

The appliance and its accessible parts become hot during use.

Care should be taken to avoid touching heating elements, and hot external and internal surfaces, including doors.

Use oven gloves.

Children less than 8 years of age shall be kept away unless continuously supervised.

**Warning**

Ensure that the appliance is switched off before replacing the lamp to avoid the possibility of electric shock.

**Warning**

The cooker must be switched off before removing the guard and, after cleaning, the guard must be replaced in accordance with the instructions.

**Warning**

Unattended cooking on a hob with fat or oil can be dangerous and may result in fire. Risk of burns and scalds.

NEVER try to extinguish a fire with water, but switch off the appliance and then cover the flames e.g. with a lid or a fire blanket.

**Warning**

A steam cleaner is not to be used on this appliance.

**Warning**

Danger of fire: do not store items on the cooking surfaces or in the oven cavities.

**Warning**

Use only hob guards designed by the manufacturer of the cooking appliance or indicated by the manufacturer of the appliance in the instructions for use as suitable or hob guards incorporated in the appliance. The use of inappropriate guards can cause accidents.

**Warning**

Do not store or use flammable liquids or items in the vicinity of this appliance.

Do not allow curtains, paper or other flammable items to come into contact with the cooker.

Do not spray aerosols in the vicinity of the appliance while it is in operation.

**Warning**

Never place food, or dishes on the base of the main oven, the element is here, and it will cause overheating.

**Warning**

Do not modify this appliance.

**Warning**

Do not place articles on or against the appliance.

**Warning**

Do not operate the appliance without the glass door panels correctly fitted.

**Warning**

The appliance must never be disconnected from the mains supply during use, as this will seriously affect the safety and performance, particularly in relation to surface temperatures becoming hot and gas operated parts not working efficiently.

The cooling fan (if fitted) is designed to run on after the control knob has been switched off.

**Warning**

Accessible parts may become hot when the grill is in use. Children should be kept away.

**Warning**

If a lid is fitted to your appliance any spillage should be removed from the lid before opening and the hob surface should be allowed to cool before closing the lid.

**Warning**

This appliance must be earthed.

**Warning**

The grill **MUST** be used with the door **OPEN**.

**Warning**

This appliance must not be used as a space heater.

**Warning**

Never use cooking vessels on the hob that overlap its edges.

Saucepan handles may become hot during use.

Keep pan handles out of the reach of children.

**Warning**

If the electrical connection cable becomes damaged, it must be replaced by a suitably-qualified person.

The cable must not be replaced by an unauthorised person.

CAUTIONS

**Caution**

In order to avoid a hazard due to inadvertent resetting of the thermal cut-out, this appliance must not be supplied through an external switching device, such as an external timer, or connected to a circuit that is regularly switched on and off by the utility.



Caution

Do not use harsh abrasive cleaners or sharp metal scrapers to clean the oven door glass / the hob surface / the glass of hinged lids of the hob (as appropriate), since they can scratch the surface, which may result in shattering of the glass.

Always ensure that the appliance is switched off before cleaning or carrying out user maintenance.

Do not clean the appliance with a steam cleaner.

Always clean up food spillages immediately, after switching the appliance off, taking care to avoid burning yourself.

Do not use scourers, sharp metal scrapers or any abrasive or corrosive cleaning agents - risk of damage and glass breakage.

Do not remove the data badge labels or clean them with corrosive cleaners.

Do not allow pans to boil dry - risk of damage to ceramic glass surface.

Do not use pans with jagged edges or drag pans across the ceramic glass surface as this can scratch the glass and lead to breakage.

Do not attempt to cook on a broken ceramic glass hotplate -risk of electric shock. Switch the appliance off immediately at the mains power supply

and call the service department.

Do not operate hob zones without a pan in place.

Do not place or drop heavy objects onto the ceramic hob surface.

Do not stand on the hob surface.

Do not allow any part of your body, hair, clothing, etc. to come into contact with the ceramic glass surface until it has cooled.



Caution

Only use the temperature probe recommended for this oven.



Caution

After use, switch off the hob zone by its control knob or touch control, and do not rely on the pan detector on induction hobs.

After use, ensure that all touch controls are switched off and that all control knobs are in the off position.



Caution

This appliance is not intended to be operated by means of an external timer or separate remote control system.

**Caution**

The cooking process must be supervised. A short-term cooking process has to be supervised continuously.

**Caution**

Accessible parts may be hot when the grill and/or the oven are in use. Young children shall be kept away.

**Caution**

Our policy is one of constant development and improvement, therefore we cannot guarantee the strict accuracy of all of our illustrations and specifications. Changes may have been made subsequent to publishing.

**Caution**

Make sure that you have removed all packaging and wrapping from the outside and inside of the appliance before it is used.

Some of the items inside this appliance may have additional wrapping.

It is advised that you turn the ovens and/or grill on for a short while. This will burn off any residues left from manufacturing. There may be a smell which accompanies this process - but this is nothing to worry about and is harmless.

It is recommended that you wash the oven shelves, grill pan, and grill pan trivet before their first use in hot soapy water. This will remove the protective oil coating used during storage.

**Caution**

When using the grill, the oven door must be kept **OPEN**.

**Caution**

This appliance is designed for cooking purposes only. It must not be used for other purposes, for example room heating.

**Caution**

When opening oven doors, grip the handle in the centre and hold it from underneath.

**Caution**

Do not cover the appliance.

**Caution**

Take care if moving the appliance, panel edges could be sharp. Failure to use caution could result in injury or cuts. Do not attempt to lift or move the appliance by pulling on the door handles.

**Caution**

If you will not be using the appliance for some time, switch off the power supply at the isolator switch on the wall.

OTHER SAFETY ADVICE

DO

- Always take care when removing food from the oven as the area around the cavity may be hot.
- Always use oven gloves when handling any cookware that has been in the oven as it will be hot.
- Always make sure that the oven shelves are resting in the correct position between two runners.
- Always use the Minute Minder (if fitted) if you are leaving the oven unattended - this reduces the risk of food burning.

DO NOT

- Never place dishes or other items on the door while it is open. Do not apply downward pressure to open oven doors. Do not allow children to climb onto open oven doors. Do not slam the oven doors shut. When shutting oven doors, ensure there is nothing obstructing them from closing. Risk of breakage.
- Never wrap foil around the oven shelves or allow foil to block the flue. Do not line the oven cavities or grill pan with aluminium foil - risk of fire. Do not use liners on the oven floors - risk of build-up of trapped heat which can cause permanent damage to the oven enamel.
- Never drape tea towels, dishcloths or clothes, etc. near the oven or from the door handles while it is on; this will cause a fire hazard.
- Never pull heavy items, such as turkeys or large joints of meat, out from the oven on the shelf, as they may overbalance and fall.
- Never use this appliance to heat anything other than food items and do not use it for heating the room.

FIRE SAFETY ADVICE

Most kitchen fires occur when people are distracted or leave things unattended. Don't let yourself be distracted while cooking. If you're called away from the cooker, either take pans off the heat, or switch off your hob.

If you do have a fire in the kitchen, don't take any risks - get everyone out of your home and call the Fire Brigade.

If a pan catches fire:

- Do not move it - it is likely to be extremely hot.
- Turn off the heat if it's safe to do so - but never lean over a pan to reach the controls.
- If you have a fire blanket, put it over the pan. If you have put the fire out, leave the pan to cool completely.

Deep-fat frying presents more dangers in your kitchen.

- Never fill a chip pan (or other deep fat fryer) more than one-third full of oil.

- **Do not use a fire extinguisher on a pan of oil - the force of the extinguisher can spread the fire and create a fireball.**

If you have an electrical fire in the kitchen:

- **Pull the plug out, or switch off the power at the fuse box - this may be enough to stop the fire immediately.**
- **Smother the fire with a fire blanket, or use a dry powder or carbon dioxide extinguisher.**
- **Remember: never use water on an electrical or cooking oil fire.**

ELECTROMAGNETIC INTERFERENCE

The functions of the hob comply with the applicable standard on electromagnetic interference.

Your induction cooking hob thus complies fully with the statutory requirements (Directive 2014/30/EU). It is designed to not interfere with the functioning of other electrical equipment as long as these also comply with the same regulations.

Your induction hob generates magnetic fields in its immediate vicinity.

So that there is no interference between your cooking hob and a pacemaker, the pacemaker must be designed in compliance with the appropriate regulations.

In this respect we can only guarantee the compliance of our own product. You can ask the pacemaker manufacturer or your doctor about the compliance or any incompatibilities of your pacemaker.

GETTING TO KNOW YOUR PRODUCT



Important

If the clock/programmer is locked, it must be unlocked before the main fanned oven can be used.

To unlock the clock/programmer press and hold the '+' key for 5-10 seconds, until the padlock symbol  disappears.

To lock the clock/programmer press and hold the '+' key for 5-10 seconds, until the padlock symbol  appears.

Your appliance layout may differ depending on the model.

COMPARTMENT OVERVIEW

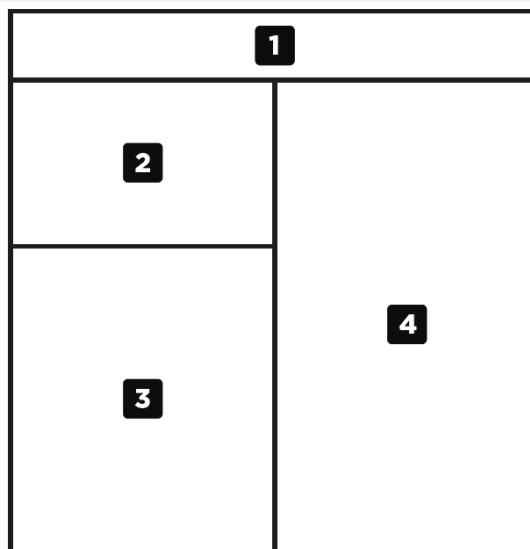

CAVITY OVERVIEW

1	Fascia - control panel
2	Grill
3	Fanned Oven with Air Fry function - the main oven which can be controlled by the timer
4	Tall Fanned Oven

CONTROL PANEL

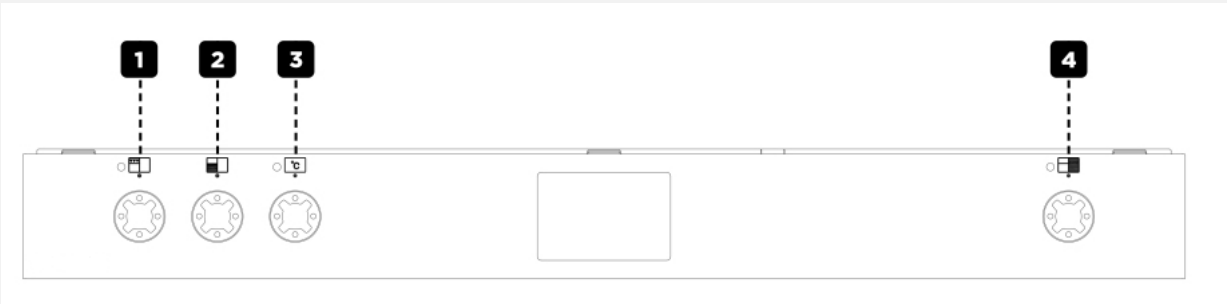

1	Grill control
2	Main oven function control
3	Main Oven Temperature control
4	Tall oven control

HOB OVERVIEW

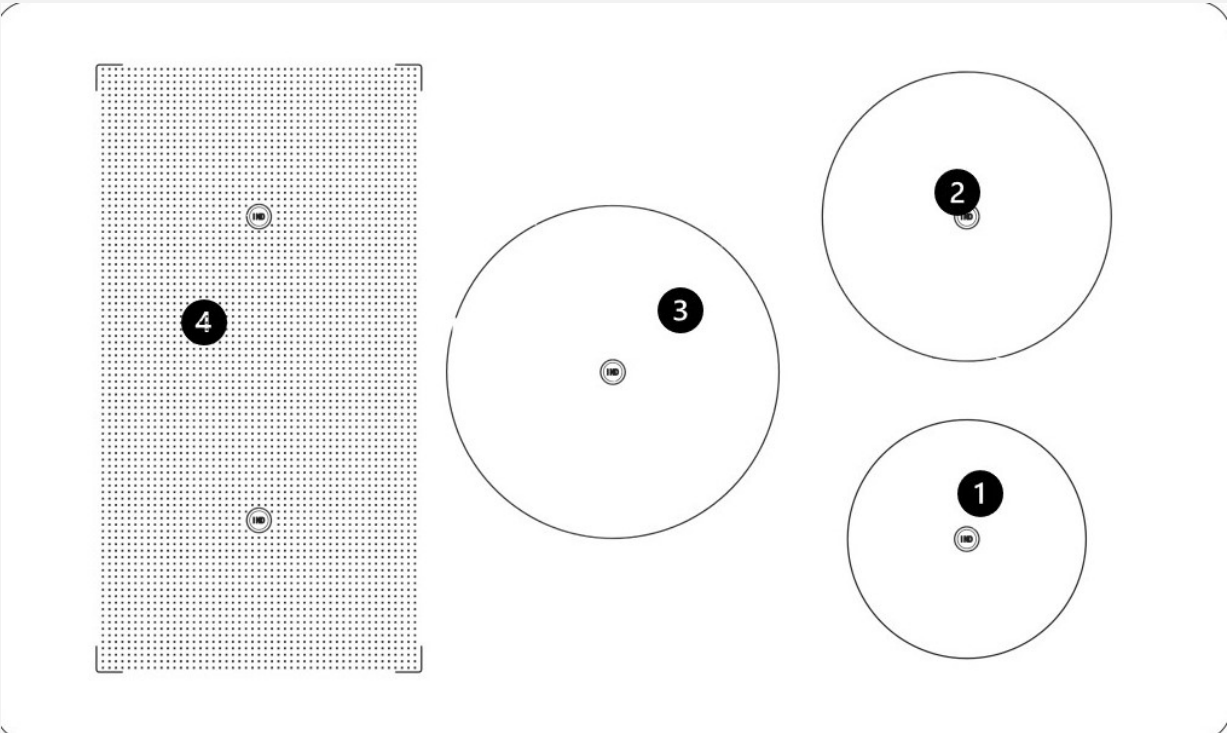

Key Number	Size	Location	Power	Recommended minimum pan size
1	Small - 160mm diameter	Front-right	1.2 kW (boost to 1.5 kW)	160mm
2	Medium - 180mm diameter	Back-right	1.8 kW (boost to 2.1 kW)	180mm
3	Large - 210mm diameter	Centre	2.3 kW (boost to 3.0 kW)	210mm
4	Can be used as two zones, each 215mm wide by 190mm long, or as one zone 215mm wide by 380mm long.	Left-hand bridged induction zone	Each zone is 1.8 kW (boost to 2.1 kW)	180mm

Smaller pans than the diameters indicated can be used. Pans must have a smooth, flat, magnetic base.

Generally, induction hobs cannot recognise pans with smaller base diameters than 100mm.

For best results, use pans with base diameters which are the same size as the printed ring, or up to 30mm larger or smaller.



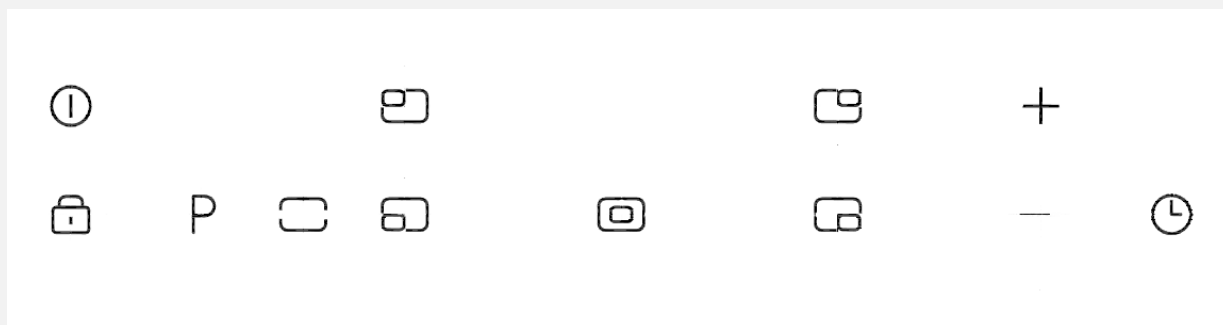

INDUCTION HOB CONTROLS (Touch Models)

INDUCTION CONTROLS ON HOB

(Layout may vary slightly dependent upon model)



INDUCTION CONTROLS (Touch models)		
Feature	Symbol	Description
Power On/ Off		Power On/Off key for the whole induction hob.
Power Boost	P	Temporarily boost the power to a cooking zone.
Adjustment key (Heat & Timer)	- +	Used to adjust the power level and cooking times.
Key Lock		Child-lock - to prevent the hob being accidentally turned on. Can also be used to prevent power level settings being accidentally changed during use.
Timer On/Off		Used to select the minute minder function and cook-to-off timers.
Cook Zone selection keys		Used to select the relevant cooking zone before adjusting the power level or cooking time. Front-left zone Back-left zone

INDUCTION CONTROLS (Touch models)		
Feature	Symbol	Description
		 Central zone - applicable to 90cm, 100cm and 110cm-wide range cookers only  Front-right zone  Back-right zone
Bridging function key		Used to activate the bridging function, so that the front-left and back-left zones can be used together as one large zone - applicable to 90cm, 100cm and 110cm-wide range cookers only.

ABOUT THE INDUCTION HOB (TOUCH CONTROLS)

The induction hob provides the most energy-efficient hob technology available.

The induction system provides superior heat up and cool down times for pans - you get fast, precise, repeatable power control.

As induction only heats up the pan, there is no lost heat from the cooking process, which in turn, limits the heat generated in the kitchen.



Warning

Never leave the hob unattended when in use, even when you have set the timer to turn off the cook zone.



Note

The safety temperature control of the pans is only possible with quality flat bottomed pans suitable for induction cooking. Poor quality pans can create air gaps between the glass and the pan, which affects the accuracy of the temperature control.



Note

Please use pans with a smooth flat magnetic base. Generally, induction hobs cannot recognise pans with a base diameter of less than 100mm.



Warning

Don't leave pans on the hob when you're not around- take them off the heat if you have to leave the kitchen (even if you think it will only be for a moment, while you answer the door or phone).

Approximate Glass Surface Temperature (°C)	Intelligent hob safety system
200	Reduces Power Boost setting to Power Level 9.
250	Reduces power to 60% of power level setting.
270	Switches cook zone off.
300	Switches whole appliance off.

TOUCH CONTROLS

The touch controls for your induction hob have been designed to provide you with finger touch control of your hob, providing accurate and repeatable power settings for cooking and an easy clean surface that can be easily wiped over.

Each cook zone displays its individual power setting.

USING THE TOUCH CONTROLS

When using the touch controls, use the flat of your finger, not the tip or finger nail. The controls respond to touch, so you don't need to apply any pressure.

Once you have powered on the induction hob, you then have a few seconds to select the cooking zone keys or timer key. If no further keys are selected within a few seconds, the hob will switch off again to save energy. If the red dashes disappear from the display, simply press the power key again to switch the hob on again.

Always ensure the control area is clean, dry and free from any objects (e.g. utensils, tea towels and cloths). Spillages and water, grease or fingerprints may make the controls less responsive.

POWERING THE HOB ON AND OFF



Touch the power key  for a couple of seconds to turn the hob on. The display lights up with some red dashes (-).

The hob can be switched off by touching the power key  for a couple of seconds. The display goes dark. The hob will also switch itself off automatically a short time after turning off the hob cooking zones, or if the

hob is switched on but no cooking zones or timer are selected.

SELECTING A COOKING ZONE AND ADJUSTING A POWER LEVEL

Power on the hob as above. Touch the relevant cooking zone key to select it (for example  for the front-left zone). '0' flashes in the display for the relevant zone.

While the '0' is flashing, touch the plus and/or minus keys   to set the required power level (with 1 being the most gentle simmer and 9 being the most rapid boil).





Tip

If you touch the plus key  first, the power level will default to level 5 and can be adjusted from there.

If you touch the minus key  first, the power level will default to level 9 and can be adjusted from there.

A few seconds after the last touch of a key, the power level is accepted and the zone continues to cook at the selected power level.

When you wish to adjust the power level, touch the relevant cooking zone key again to select it. The current power level will flash in the display for the relevant zone. While the display is flashing, touch the plus and/or minus keys   to adjust the power level.

Adjusting the power level down to 0 switches the cooking zone off. You can also touch the power key  to switch all of the cooking zones off.

POWER BOOST

The power boost function can be used to temporarily boost the power to a cooking zone by 'borrowing' extra power from an adjacent zone.

All the cooking zones can be boosted, but not all at the same time. You cannot boost two zones on the same side of the hob at the same time.

After powering on the hob, touch the relevant cooking zone key to select it (for example  for the front-left zone). '0' flashes in the display for the relevant zone.

While the '0' is flashing, touch the power boost key ; 'P' appears in the display to show that power boost is active.

The power boost function runs for approximately 5 minutes and then the cooking zone will change to power level 9. The power boost function can also be cancelled at any time by selecting a different power level or by turning the cooking zone off.



Note

The Power Boost function will only operate for a limited time and is also under thermal control. This means that Power Boost will deactivate automatically if the product gets too hot, to protect the internal electronic components of the hob and to prevent the cookware from overheating.



If using two pans on the same side of the hob, if one zone is on power boost the other zone's power level may need to be limited to a lower power level to prevent the appliance drawing too much power. For this reason, you may see cooking zone power levels reduce automatically.

Pans tend to heat up quickly on induction hobs. Please do not overfill pans to prevent boiling over, especially when using the power boost function. Do not leave pans unattended when using the power boost function.

BRIDGING FUNCTION

The bridging function allows the front-left and back-left cooking zones to be used as one large zone to accommodate larger pans. This function is available on the 90cm, 100cm and 110cm-wide range cooker versions.

After switching the hob on, touch the bridge key  to activate the bridging function. '0' flashes in the back-left zone display and '=' shows in the front-left zone display.

While the '0' is flashing, touch the plus and/or minus keys   to set the required power

level. You can also touch the power boost key **P** to select power boost when the zones are bridged. The power level will be displayed in the back-left zone display.

The bridging function can be cancelled at any time by touching the bridge key  again. The front-left and back-left zones can then be used as two separate zones again.



ACTIVATING AND DEACTIVATING THE CHILD LOCK

The lock function can be used in two ways - to prevent the hob cooking zones being accidentally turned on, for example by a child, and to prevent the power settings from being accidentally changed in use, for example while simmering.

To prevent the hob zones being turned on accidentally, touch the padlock key  for a few seconds, until 'LO' appears in the hob timer display.

If the hob is now switched on by the power key , 'LO' flashes in the hob timer display and the hob cooking zones cannot be switched on.

To deactivate the child lock, after switching the hob on, touch the padlock key  for a few seconds until 'LO' disappears from the timer display. The hob can now be operated as usual.

To prevent the power settings from being changed accidentally, after setting the required simmer power levels, touch the padlock key  for a few seconds until 'LO' appears steadily in the hob timer display. The hob touch control keys are now locked so that the simmer power levels cannot be adjusted. The hob can still be switched off using the power key .

To deactivate the in-use lock, touch the padlock key  for a few seconds until 'LO' disappears from the timer display. The touch controls can then be operated as usual.

Please note the child lock function is maintained even after powering the hob off and on via the power key .

USING THE MINUTE MINDER



The hob minute minder can be used to remind you to check or stir the food, but does not switch a cooking zone off automatically.



Note



The hob minute minder is only available if at least one hob cooking zone is in use.



Set the cooking zone power levels first. While none of the cooking zones are currently selected (that is, the zone power level displays are steady and not flashing), touch the clock key . '00' flashes in the hob timer display.

While the '00' is flashing, use the plus and/or minus keys   to set the required minute minder duration time (between 1 minute and 99 minutes).



Tip

Short touches of the plus  and minus  keys increase/decrease the minute minder duration time by one minute at a time.

Long touches of the plus  and minus  keys increase/decrease the minute minder duration time by ten minutes at a time.

A few seconds after the last key press, the duration time is accepted and starts counting down.

If you need to amend or cancel the minute minder time, touch the clock key  again. The remaining duration time flashes and you can adjust the duration time using the plus and/or

minus keys **+ -**. Adjusting the duration time down to 0 cancels the minute minder function.

When the minute minder duration time has elapsed, the alarm sounds for approximately 30 seconds. You can silence the alarm by touching the clock key . The hob cooking zone(s) will need to be turned off manually.

USING THE COOK-TO-OFF TIMER

The cook-to-off timer allows one or more cooking zones to be switched off automatically after a certain amount of time, for example after a certain period of simmering.

After switching the hob on, touch the relevant zone key (for example  for the front-left zone).

While the power level is flashing in the display, use the plus and/or minus keys **+ -** to set the required power level.

While the power level is still flashing in the display, touch the clock key . (If the power level has stopped flashing in the display, simply touch the relevant zone key again to make the display flash again). '00' flashes in the hob timer display.

While '00' is flashing in the hob timer display, use the plus and/or minus keys **+ -** to set the required timer duration time (between 1 minute and 99 minutes).









Tip

Short touches of the plus **+ and minus **-** keys increase/decrease the timer duration time by one minute at a time.**

Long touches of the plus **+ and minus **-** keys increase/decrease the timer duration time by ten minutes at a time.**

counting down. A dot appears next to the relevant cooking zone power level display to show that the zone is being controlled by the timer.

If you need to **amend or cancel the timer duration time**, touch the relevant zone key (   ) to select the zone. Then touch the clock key . The current remaining timer duration time flashes in the display. While the duration time is flashing, use the plus and/or minus keys to adjust the timer duration time. Adjusting the timer duration time down to 0 will cancel the cook-to-off timer function. Please note, in this case the cooking zone would need to be switched off manually.

When the cooking duration time has elapsed, the cooking zone is switched off and the alarm sounds for approximately 30 seconds. You can silence the alarm by touching the clock key .

A few seconds after the last key press, the timer duration time is accepted and starts



Note

All of the cooking zones can be controlled by the cook-to-off timer. Repeat the above steps if you wish to use the cook-to-off timer on another zone simultaneously.



The hob timer display can only display the remaining duration time for one cooking zone timer or minute minder at a time. To indicate for which zone the remaining time is being displayed, a flashing dot will show next to the relevant cooking zone power level display. A steady dot next to a cooking zone power level display indicates that the cooking zone is being controlled by the timer, but the timer display is not currently showing the remaining duration time for that zone. Touch the relevant zone key to briefly see the remaining duration time for that zone in the hob timer display.

If there are zone cook-to-off timers and the minute minder running concurrently, the minute minder takes priority and shows in the hob timer display. To check the remaining duration time for the zone cook-to-off timers, touch the relevant zone key to briefly see the remaining duration time for that zone in the hob timer display.

INDUCTION SYMBOLS AND CODES

The hob display can show information codes, and codes to alert you to any issues which may need to be resolved.

Induction Symbols And Codes

Symbol / Code	Meaning	Description
	Pan missing, or unsuitable pan.	If the electronics cannot detect the pan, because it is too small or does not have a magnetic base, then the hob display will show the missing or unsuitable pan symbol.
	Residual heat indicator.	When the hob is switched off after use, if the glass surface is still hot, the residual heat indicator will be displayed. The residual heat symbol will automatically go out when the glass surface temperature cools (to below approximately 45°C). The cooling fan runs for a while after the hob is switched off to help cool the hob electronics.
	Power boost.	Power boost is active.
ER03	Obstruction.	Something is covering the hob control area, such as a pan, utensil or cloth, or even just water, grease or finger prints . Remove any items and clean the area before using the hob again. Do not touch any of the hob touch control keys for more than 10 seconds.
E1 or E2	Over-heat indicator.	The hotplate may have over-heated, possibly because an empty pan has been heated for too long or a pan has boiled dry. Remove the pans and allow the hob to cool down for about 30 minutes before trying to use it again.
E3 or E4	Possible issue with electricity supply.	The electrical voltage supplying the cooker may be too high or too low. Switch the cooker off at the wall and contact your local electricity board for assistance.
LO	Child lock.	The child lock has been activated.

For other codes, please switch the appliance off at the wall for a few minutes to let the electronics reset. If the code reappears when

the power is restored, please contact our customer support team using the details on the back cover.

MAXIMUM OPERATING TIMES FOR INDUCTION HOB ZONES

For safety reasons, an induction hob zone cannot operate for longer than a maximum time before switching off and cooling down.

Maximum Operation Times For Induction Hob Zones

Power level	Maximum operating time
1	6 hours
2	6 hours
3	6 hours
4	3 hours
5	3 hours
6	3 hours
7	2 hours
8	2 hours
9	1.5 hours
Power Boost	5 minutes (plus a further 90 minutes at power level 9)



Note

1 is for the lowest heat output; 8 is for the highest heat output.

Use the grill with the door open.

MAIN OVEN OVERVIEW

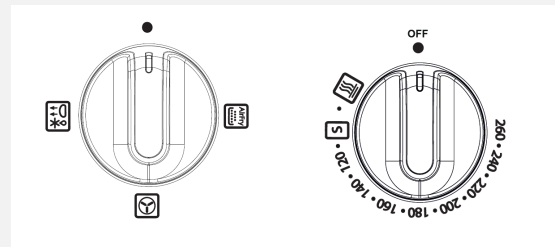



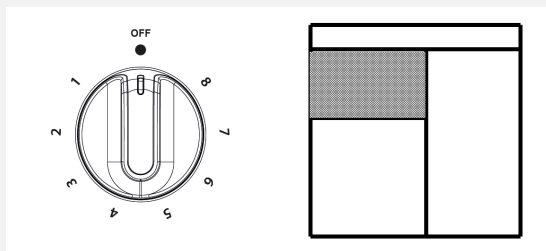

To operate the main oven please select a cooking function with the left-hand control knob and a temperature with the right-hand control knob.

GRILL CONTROL DIAL



MAIN OVEN COOKING FUNCTIONS AND SETTINGS

Symbol	Function
	<p>Fanned Oven</p> <p>Use any suitable shelf position.</p> <p>Can batch bake on more than one level simultaneously - leave enough room for baking to rise.</p> <p>Requires little to no pre-heating.</p> <p>Reduce the temperature by around 20°C and reduce cooking time a little compared to conventional ovens. Ensure food is thoroughly cooked through prior to serving.</p>
	<p>Air-Fry function</p> <p>For best results, lay out the food in one layer on the air-fryer tray, as evenly-spaced as possible.</p> <p>Insert the air-fryer tray into the middle shelf position of the main oven.</p> <p>Insert the grill pan into the lower shelf position of the main oven, beneath the air-fryer tray, to catch any drips.</p> <p>Turn the main oven function control dial to the air-fry function and turn the main oven control dial to 220°C.</p> <p>For best results, when consulting recipes and cooking instructions on food packaging, please look for the conventional oven timings, not the worktop air-fryer timings or regular fanned oven timings. Reduce the conventional oven timings by about 30%. Ensure that the food is thoroughly cooked prior to serving.</p> <p>The air-fry function is great for cooking chips, potato wedges, vegetables, chicken pieces, chicken nuggets, and any foods which you would normally grill.</p> <p>However, the air-fry function is not suitable for baking cakes, pastries or breads, as they may become tough, and is not designed for frying foods in a wet batter.</p>
	<p>Defrost / dough-proving</p> <p>Leave the main oven temperature control in the off position.</p> <p>Use with the door closed to defrost frozen bread or gateaux, or when leaving dough to rise prior to baking.</p> <p>Use with the door open to cool cooked food prior to refrigerating.</p>



Symbol	Function
	Keep warm temperature setting - 70°C Use in conjunction with the fanned oven function.
	Slow cook temperature setting - 100°C Used for slow cooking of casseroles, chillis, stews, etc. Use in conjunction with the fanned oven function.

TALL OVEN OVERVIEW

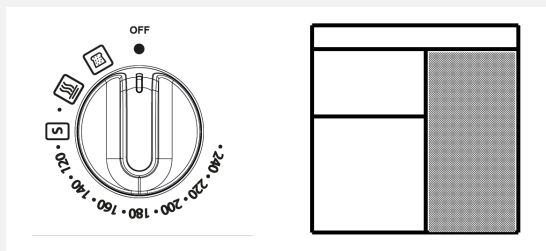
Turn the tall oven control dial to the temperature or setting required.



Tall Oven Cooking Functions

Symbol	Description
120 to 240	Fanned oven Use any suitable shelf position. Can batch bake on more than one level simultaneously - leave enough room for baking to rise. Requires little to no pre-heating. Reduce the temperature by around 20°C and reduce cooking time a little compared to conventional ovens. Ensure food is thoroughly cooked through prior to serving.
	Slow cook temperature setting - 100°C Used for slow cooking of casseroles, chillis, stews, etc.
	Keep warm temperature setting - 70°C

Symbol	Description
	<p data-bbox="418 250 754 286">Defrost / dough-proving</p> <p data-bbox="418 320 1356 394">Use with the door closed to defrost frozen bread or gateaux, or when leaving dough to rise prior to baking.</p> <p data-bbox="418 427 1310 463">Use with the door open to cool cooked food prior to refrigerating.</p>

USING THE GRILL

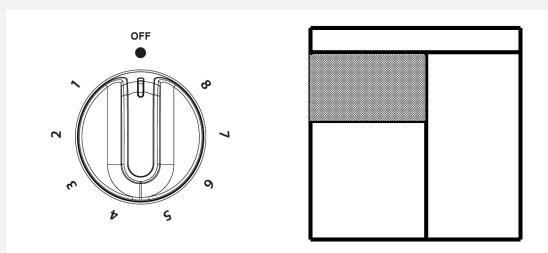

Warning

Never cover the grill pan or grill trivet with aluminium foil, or allow fat to build up in the grill pan, as this creates a fire hazard.



Tip

For best grilling results pre-heat the grill for up to 5 minutes, and choose a suitable mid-to-high shelf position to bring the food close to the grill element, while leaving enough space so that the food does not touch the grill element.

THE COOLING FAN

During use the fan may cycle on and off, this is normal.

When the grill is switched on, the cooking fan may not come on immediately, but will then come on to keep the fascia and control knobs cool during grilling. The fan may continue to operate for a period after the grill has been switched off.



Note

The cooling fan may run for around 1 hour after use. This is normal to ensure the exterior parts of the cooker fully cool down and because the oven cavity is very well-insulated to prevent heat escaping during the cooking process. Please do not switch the cooker off at the wall before the cooling fan has stopped completely.

USING THE GRILL



Caution

Accessible parts may be hot when the grill is used—young children should be kept away.



Important

The grill door must be fully open when the grill is used.

1. Open the grill door. Turn the control knob to the required setting. 1 is the lowest heat and 8 is the highest heat. For best cooking results, we recommend that you preheat the grill for about 5 minutes.
2. Place the food centrally on the grill pan trivet.
3. Push the grill pan in to position it under the grill.
4. To switch off return the control knob to the off position.

GRILL PAN AND TRIVET

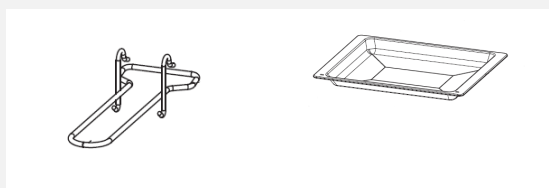

The trivet sits inside the grill-pan.

The holes and the sloping lip of the grill-pan go at the back.

The grill-pan handle clips over the front of the grill-pan. Ensure that the grill-pan handle prongs are at the top, and the wider support piece sits underneath the grill-pan.



Warning

The grill-pan handle is designed for sliding the grill-pan in and out. Do not attempt to carry the grill pan by the handle.



Warning

The top oven/grill door must be open when the grill is used for conventional grilling.

USING THE MAIN OVEN

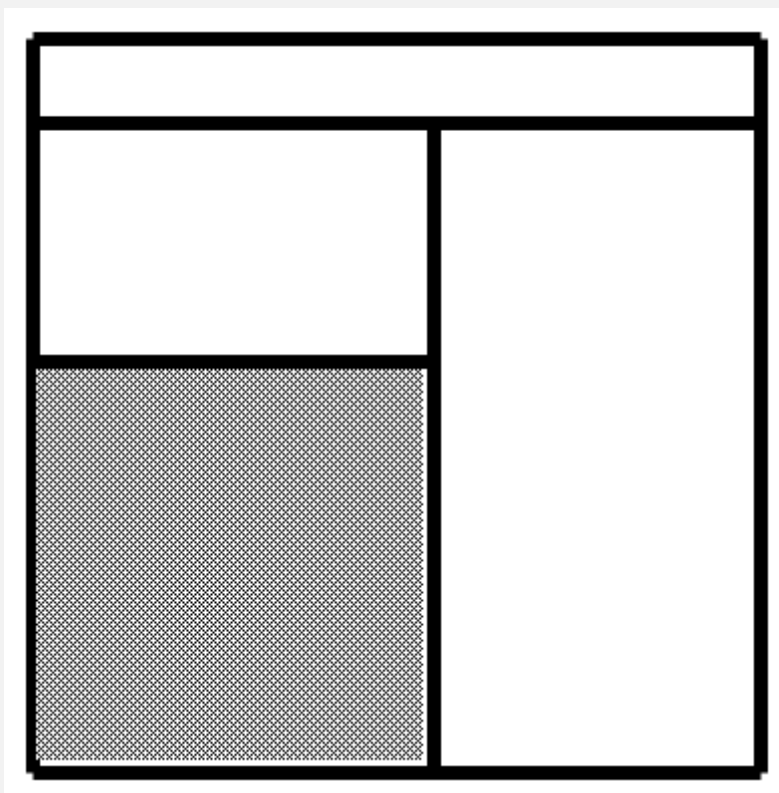

Warning

Accessible parts may be hot when the oven is used. Young children should be kept away.

SETTING A HEATING OPERATION

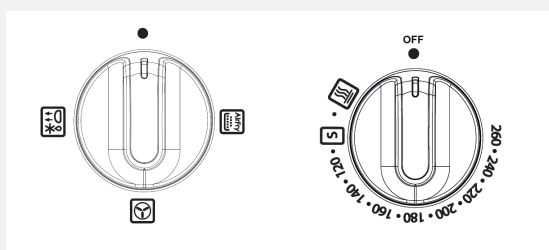

To start a heating operation, a heating function and a heating temperature must be selected.

Setting a heating function

- Rotate the function control to select the desired heating function.

To modify or cancel the heating function:

- Rotate the function control to select another heating function.
- Rotate the function control to the off position to cancel the heating function.

Setting a heating temperature:

- Rotate the temperature control to select the desired heating temperature.

To modify or cancel the heating temperature:

- Rotate the temperature control to select another heating temperature.
- Rotate the temperature control to the off position to cancel the heating temperature.

PREHEATING

The oven starts preheating when a heating function and heating temperature have been set.

The neon light next to the main oven temperature control knob lights up when the oven is pre-heating, and goes out when it has reached temperature.

COOKING WITH A FANNED OVEN



Caution

As this is a high efficiency oven, you may notice the emission of steam from the oven when the door is opened. Please take care when opening the door.

If you are used to cooking with a conventional oven you will find a number of differences to cooking with a fan oven which will require a different approach.



Tip

Foods are cooked at a lower temperature than a conventional oven, so conventional recipe temperatures may have to be reduced by about 20°C.



Tip

Preheating is generally not necessary as a fan oven warms up quickly.



Tip

There is no flavour transference in a fan oven, which means you can cook strong smelling foods such as fish at the same time as mild foods- e.g. milk puddings.



Tip

When batch baking foods that will rise during cooking- e.g. bread, always ensure that enough space has been left between the shelves to allow for the rise.

- There are no zones of heat in a fan oven as the convection fan at the back of the oven ensures an even temperature throughout the oven. This makes it ideal for batch baking - e.g. when planning a party as all the items will be cooked within the same length of time.



Note

When 2 or more shelves are being used, it may be necessary to increase the cooking time slightly.



Note

Because the 2 oven shelves are wider than in many ovens, it is possible to cook 2 items per shelf.



Note

When roasting meats, you will notice that fat splashing is reduced, which is due in part to the lower oven temperatures, and will help keep cleaning of the oven to a minimum.

**Note**

There is no need to interchange dishes onto different shelf levels part way through cooking, as with a conventional oven.

**Note**

A 1½kg/ 3lb oven ready chicken will take approximately 5 hours, remove the giblets as soon as possible.

DEFROSTING AND COOLING IN THE MAIN OVEN

To defrost frozen foods, turn the oven control to the defrost position, place the food in the centre of the oven and close the door. Leave the temperature selector in the off position.

To cool foods after cooking prior to refrigerating or freezing, turn the main oven control to the defrost position and open the door. Leave the temperature selector in the off position.

DEFROSTING TIMES**Note**

Small or thin pieces of frozen fish or meat- e.g. fish fillets, prawns or mince will take approximately 1-2 hours.

**Note**

Placing food in a single layer will reduce the thawing time.

**Note**

A medium sized casserole or stew will take approximately 3-4 hours.

**Caution**

BE SAFE:

Do not defrost stuffed poultry using this method.

Do not defrost larger joints of meat and poultry over 2kg/ 4lb using this method.

USING THE DOUGH-PROVING FUNCTION

- After kneading the dough, add the dough to a suitably-sized greased bread-baking tin. The dough should roughly half-fill the tin.
- Cover the baking tin with cling film.

**Tip**

It is a good idea to brush the underside of the cling film with a little vegetable oil to help prevent the dough sticking to the cling film when it rises.

- Place the covered baking tin in the cold oven and close the door.
- Select the dough-proving function on the function selector. Do not select a temperature - leave the temperature selector control in the 'off' position.
- Leave the dough in the oven for approximately 1-2 hours to allow time for the dough to rise, roughly doubling in size and filling the baking tin.
- Remove the cling film and bake the dough as usual.

USING THE AIRFRY FUNCTION

Simply choose the AirFry setting on the main oven, then place your chips, vegetables or chicken on the specially designed air fryer tray.

The tray allows more air to circulate speeding up cooking time, reducing the need for any extra oils making cooking healthier.

AirFry is great for cooking chips, meat and to prepare foods that you would normally grill.

There's a few things which don't AirFry well including cakes, pastries and breads as they can become dry or tough. Foods in a wet batter also can not be cooked by AirFrying.

1. Select the AirFry function on the main oven and set the temperature to 220°C.
2. Position the metal Airfry tray on the 3rd (centre) shelf position from the bottom. Food should be evenly spaced on the AirFry tray in a single layer to allow for even cooking.
3. Place a baking tray on the shelf position below the AirFry tray to catch any crumbs or drips.



Warning

For recipes with 30 minutes or longer cooking time a 5-10 minute pre-heat time is recommended.

Frozen or dense foods may require additional cooking time.



Note

If you're using a non-air fryer recipe, make sure you shorten the cooking time as food will cook faster than in a conventional oven.



Important

- Air Frying in a large oven cavity allows for more food to be air-fried simultaneously, so longer cooking times are to be expected compared to a worktop air fryer. Please adjust cooking times accordingly.
- For best results, when consulting recipes and cooking instructions on food packaging, please look for the conventional oven timings, not the worktop air fryer timings or regular fanned oven timings.
- Reduce the conventional oven timings by around 30%.
- Ensure that the food is thoroughly cooked prior to serving.



Note

It may be necessary to lightly spray the AirFry tray with oil to avoid food sticking to it.







Important

Greasy foods may cause smoke during the AirFry cycle, maintaining a clean oven and using a baking tray below to catch debris is recommended.

MAIN OVEN FUNCTIONS

With the exception of defrost/dough-proving, both a cooking function and a temperature

must be selected in order for the main oven to work.

<p>Fanned Oven</p> <p>Use any suitable shelf position.</p> <p>Can batch bake on more than one level - please leave enough space between shelves to allow baking to rise.</p> <p>Does not generally require pre-heating.</p> <p>Reduce cooking temperature by around 20°C, and reduce the cooking time a little, compared to conventional ovens.</p>	
<p>Air Fryer</p> <p>Place the air fryer tray in the middle shelf position.</p> <p>Place the grill pan below it to catch any drips or food particles.</p>	
<p>Defrost/Dough proving</p> <p>Leave the main oven temperature control in the off position.</p> <p>Use with the door closed for defrosting frozen items (such as bread and gateaux).</p> <p>Use with the door open for cooling cooked food prior to refrigeration.</p>	
<p>Slow Cook - 100°C</p> <p>For the slow cooking of casseroles, stews, chillis, etc.</p> <p>Used in conjunction with the fan oven setting.</p>	
<p>Keep Warm - 70°C</p> <p>For keeping cooked food warm prior to serving.</p> <p>Not suitable for reheating cooked food which has already gone cold.</p> <p>Used in conjunction with the fan oven setting.</p>	

OVEN FURNITURE

Extra shelves may be ordered from our spares website - please see website address on the back cover.

Type of shelf	Type of model	Cavity	Part number
50cm	Belling RCA Cookcentre and Farmhouse range cookers	All cavities except right-hand tall oven cavity on 90cm models.	094108600
40cm	Belling RCA Cookcentre and Farmhouse range cookers - 90cm models only	Only for right-hand tall oven cavity on 90cm models.	094108602

Baking trays and roasting tins:

For best cooking results and even browning, the recommended size of baking trays and roasting tins that should be used are as follows;

- **Baking tray 350 mm x 250 mm** This size of baking tray will hold up to 12 small cakes.
- **Roasting tin 370 mm x 320 mm**

Position baking trays and roasting tins on the middle of the shelves, and leave one clear shelf-position between shelves, to allow for circulation of heat.

USING THE PROGRAMMABLE TIMER



Notice

If the clock/programmer is locked, it must be unlocked before the main oven can be used.

To lock/unlock the clock/programmer, press and hold the '+' key for 5-10 seconds until the padlock symbol appears/disappears.

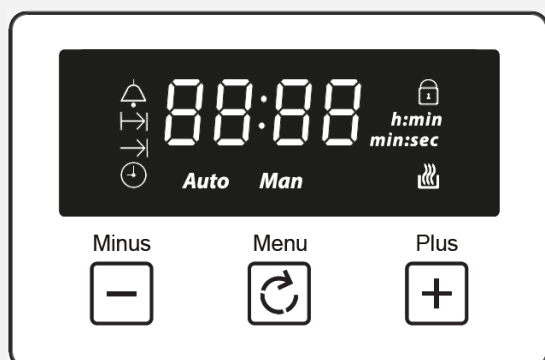

The main oven will not work until the time of day has been set.

Please be aware that only the main fanned oven is controlled by the programmer.



Symbol	Description
	Alarm (Minute Minder) - reminds you to check, turn, stir or baste food after a set time, but does not switch the oven off automatically.
	Cooking duration time - allows the main oven to switch off automatically.

Symbol	Description
	End of Cooking time - used in conjunction with the cooking duration time, allows the main oven to switch on and off automatically, so you can put food in the oven before going out and have it ready for your return.
	Clock - for setting the time of day.
Auto	Automatic Cooking Mode - the main oven will switch off (or on and off) automatically.
Man	Manual Cooking Mode - the main oven can be used manually.
	Adjustment Keys For adjusting the volume level and times. Left key: minus/decrease. Right key: plus/increase.

Symbol	Description
	Menu key (function key) - allows you to select the timer functions. Each press of the menu key scrolls through the timer functions menu in the following order: minute minder; set cooking duration time; set cooking end time; set time of day; adjust volume level.
<i>h:min</i>	Units of time (hours: minutes, or minutes: seconds).
88:88	Time Display. The main oven will not work until the time of day has been set.
	Heating indicator. The main oven is in use.
	<p>Child-lock is active - the timer keys will not respond and the main oven will not work until the child-lock is deactivated.</p> <p>To lock/unlock the clock/ programmer, press and hold the '+' key for 5-10 seconds until the padlock symbol appears/disappears.</p>
L 1.L2.L3	Timer volume / pitch - L1 is the quietest level, L3 is the loudest level.

The main oven will not work until the time of day has been set.



While the clock symbol is flashing, use the plus and/or minus keys to select the current time of day, using the 24 hour format.



Tip

If you hold down the plus or minus key the time will change more quickly.

The time of day will be accepted a few seconds after the last key press and the clock symbol will stop flashing.

To adjust the time of day, for example at the beginning and end of daylight saving time, touch the 'Menu' key  four times until the clock symbol  starts to flash.

While the clock symbol is flashing, use the plus and/or minus keys to select the current time of day, using the 24 hour format.

The time of day will be accepted a few seconds after the last key press and the clock symbol will stop flashing.



Notice

The main oven functions will not work until the clock time of day has been set.

SETTING THE TIME OF DAY

When the cooker is first connected to the power supply, or following a power cut, the clock symbol  will be flashing on the display.



Notice

A short time after the last touch of a timer key (after approximately 60 seconds), the timer display will dim a little.

This is an energy-saving function.

Pressing any timer key will brighten the timer display again.

MANUAL MODE

If you do not wish to set a cooking duration time or cooking end time on the programmable timer, then the main oven can be switched on and off manually using the function control and temperature control knobs.

To operate the main oven manually, the time of day must be set on the clock, the child lock must not be activated on the timer, and the display must show ^{Man} to indicate manual mode.

If necessary, touch the menu key  twice until 'Man' ^{Man} appears steadily in the display.

MINUTE MINDER

The minute minder function sounds an alarm after a set time to remind you to check, turn, stir or baste food. It does not switch the main oven off automatically.



Touch the middle 'Menu' key  once. The minute minder bell symbol  flashes.

While the bell symbol is flashing, use the plus and/or minus keys  to set the required time (up to a maximum of 99 minutes).

After a few seconds, the time entered is accepted, the bell symbol stops flashing and shows steadily, and the remaining minute minder time counts down in the display.

When the time has elapsed, the alarm sounds. Touch the middle 'Menu' key  to silence the

alarm, or the alarm will stop automatically after about 5 minutes.

If you want to change or cancel the minute minder time, touch the 'Menu' key  again until the bell symbol  flashes.

While the bell symbol is flashing, use the plus and/or minus keys  to adjust the required time, or take the time down to 00:00 (h: min) to cancel the minute minder function.

SEMI-AUTOMATIC COOKING





Notice

The timer can only operate the main oven automatically when a function and a temperature have been selected.

Semi-automatic cooking switches the oven off after a set time.

Ensure that the time of day has been set.



Place the food in the main oven and select a cooking function and temperature.

Touch the 'Menu' key  twice until the cooking duration symbol  flashes.

While the cooking duration symbol is flashing, use the plus and/or minus keys  to set the time required (up to a maximum of 23 hours and 59 minutes).

After a few seconds, the time entered is accepted, the duration symbol  stops flashing and shows steadily.

The display shows 'Auto' ^{Auto} along with the cookpot symbol .

If you want to check the remaining duration time, change it or cancel it, touch the 'Menu' key  twice again until the duration symbol  flashes. The remaining time appears briefly on the display.

While the duration symbol is flashing, you can use the plus and/or minus keys $\square\pm$ to adjust the duration time, or take the time down to 00:00 (h: min) to cancel the semi-automatic cooking function.

When the duration time has elapsed, the alarm sounds and the oven heating is turned off.

Touch the 'Menu' key Menu once to silence the alarm. 'Man' Man flashes in the display.

Remember to turn the function selector and temperature selectors off. Then touch the 'Menu' key Menu again to return to manual mode. 'Man' Man appears steadily in the display.

FULLY-AUTOMATIC COOKING

With fully-automatic cooking you can place the food in the oven before going out. The timer will switch the main oven on and off automatically using set times so that the food is ready for your return.

Ensure that the time of day has been set.

Place the food in the main oven and select a cooking function and temperature.

Set the cooking duration time as described above.

Touch the 'Menu' key Menu three times until the cooking end time symbol \rightarrow flashes.

While the cooking end time symbol is flashing, use the plus and/or minus keys $\square\pm$ to set the required end time.

After a few seconds, the end time is accepted, the end time symbol \rightarrow stops flashing and shows steadily.

The display shows 'Auto' Auto .

The timer will calculate the required start time (for example, a cooking duration time of 1 hour and a required end time of 18.00 = required start time of 17.00).

If you want to check the end time, change it or cancel it, touch the 'Menu' key Menu three times again until the end time symbol \rightarrow flashes. The end time appears briefly on the display.

While the end time symbol is flashing, you can use the plus and/or minus keys $\square\pm$ to adjust the end time, or take the time down to the current time of day to cancel the fully-automatic cooking function.

When the required start time arrives, the cookpot symbol Cookpot lights up and the oven heating is switched on.

When the end time arrives, the alarm sounds and the oven heating is turned off.

Touch the 'Menu' key Menu once to silence the alarm. 'Man' Man flashes in the display.

Remember to turn the function selector and temperature selectors off. Then touch the 'Menu' key Menu again to return to manual mode. 'Man' Man appears steadily in the display.



Notice

When entering times, the time entered is automatically accepted around 5 seconds after the last key touch.





Notice

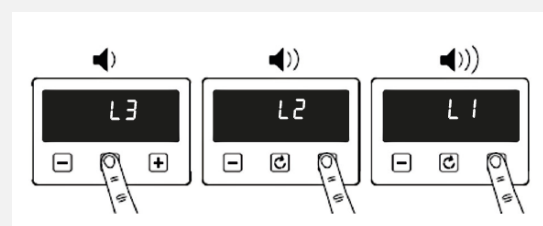

The minute minder counts down in the foreground.

The cooking duration time and cooking end times count down in the background while the display shows the current time of day.

ADJUSTING THE VOLUME LEVEL





To adjust the volume level, touch the menu key  five times until 'L1', 'L2' or 'L3' appears on the display.



Use the plus  and/or minus  keys to select a volume level, which changes the pitch.

L1 is the quietest level; L3 is the loudest level.

ACTIVATING AND DEACTIVATING THE CHILD-LOCK



To activate the timer child-lock, press and hold the plus key  for 5-10 seconds until the padlock symbol  appears in the display.

While the child-lock is active pressing the timer keys has no effect and the main oven cannot be turned on.

To deactivate the timer child-lock, press and hold the plus key  for 5-10 seconds until the padlock symbol  disappears from the display.

The timer can now be operated again normally.

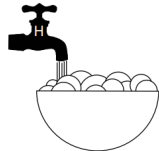
CLEANING YOUR APPLIANCE

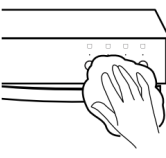
Cleaning: Do's	
	Use warm, soapy water
	Wipe the appliance with a damp cloth <ul style="list-style-type: none"> • Clean the cloth regularly
	Dry with a soft dry cloth

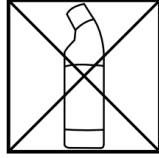
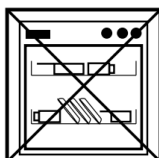
Cleaning: Don'ts	
	Don't use undiluted bleaches or Chloride products
	Don't use Wire Wool, Abrasive cleaners, Nylon pads or Steam Cleaners
	Do not wash the cast iron griddle, wok cradle, pan supports or telescopic sliders in the dishwasher



Note

Always switch off your appliance and allow it to cool down before you clean any part of it.



Note

Please take extra care when cleaning over the symbols on the control panel, as this can lead to them fading.



Note

Tips: Some foods can mark or damage the metal or paint work e.g; Vinegar, fruit juices and salt. Always clean food spillages as soon as possible.



Caution

It is important to clean your appliance regularly as a build up of fat can affect its performance or damage it and may invalidate your guarantee.



Caution

In addition to the above, do not use metal scrapers to clean the oven door glass, ceramic hob surface or any glass lids.

CLEANING AND CARE GUIDANCE

Area of appliance / material	Cleaning guidance	Example products
Ceramic glass hotplates	<ul style="list-style-type: none"> • Clean with a ceramic hotplate cleaner/conditioner, applied with kitchen paper, following the instructions on the package. • Rinse with a damp, well-wrung out soft cloth. • Polish dry with a microfibre cloth. • If you do ever use a hob scraper to remove stubborn marks or deposits, please apply some ceramic hob cleaner onto the ceramic glass surface first, so that the hob scraper blade can glide across, at a 45° angle, without scratching the surface. • Please note that the cooker manufacturer cannot accept responsibility for scratches or damage to the ceramic glass surface caused by the use of a hob scraper. • Kitchen foil and spillages of sugary foods must not be allowed to bake onto the ceramic glass surface as they may cause pitting of the glass. • They must be removed immediately, even if the hob is still hot, taking care not to burn yourself. • Please be aware that pans with aluminium in the base can tend to leave marks on ceramic glass surfaces. • New hobs can sometimes show white 'bloom' marks which are related to manufacturing residues. • Apply some lemon juice to the glass surface and leave to soak for a while before cleaning with ceramic hob cleaner, rinsing and drying. • Do not clean ceramic hobs with washing-up liquid as it can sometimes leave behind a blue sheen. 	<ul style="list-style-type: none"> • Ceramic hob cream cleaner. • Microfibre cloths.

Area of appliance / material	Cleaning guidance	Example products
<p>Chrome oven shelves, grill pan trivets, shelf guides and telescopic sliders</p>	<ul style="list-style-type: none"> • Immerse a soft cloth in warm soapy water, wring out and wipe the shelves and shelf guides. • For heavier soiling, soak in warm soapy water, then clean with a non-scratch sponge. • Wave-shaped sponges can be useful for cleaning chrome shelves and grill pan trivets. • Wipe telescopic sliders with a damp cloth. Do not wash them in the dishwasher as the detergent will remove the lubricant from the runners which can prevent gliding and make them stiff. 	<ul style="list-style-type: none"> • Washing-up liquid. • Wave-shaped sponge.
<p>Control knobs and bezels</p>	<ul style="list-style-type: none"> • Wipe with a damp cloth. • On most models control knobs can be removed for more through cleaning in warm soapy water. • Please refer to the section for removing and replacing the knobs, bezels and the springs that go in between them. • It is a good idea to keep the user guide handy, or to take some photographs before you start removing the control knobs, so that you will be able to see which knob and bezel goes in which position when you are refitting them. • Do not attempt to remove control knobs from pyrolytic oven models, or from models with retractable control knobs. 	<ul style="list-style-type: none"> • Washing-up liquid.

Area of appliance / material	Cleaning guidance	Example products
<p>Enamelled oven cavities and grill pans</p>	<ul style="list-style-type: none"> • Wash with warm soapy water. • For heavier soiling, use a proprietary oven cleaner spray or gel, leave to work for as long as recommended in the instructions, then wipe away and rinse. • Do not allow oven cleaners to come into contact with stainless steel, aluminium or chrome parts, shelves, shelf supports, door seals, heating elements, or fascias with printed markings. • Do not allow fat to build up in grill pans and do not line grill pans with aluminium foil as this presents a risk of fire. • Grill pans can be lined with special non-stick PTFE cooking liners. • Non-stick PTFE cooking liners can reduce soiling in ovens. • Place these liners on the lower shelf, below the shelf where the food is being cooked, not on the floor of the oven cavity as this could block heat from the base element and cause damage. 	<ul style="list-style-type: none"> • Washing-up liquid. • Proprietary oven cleaner. • Non-stick PTFE cooking liners.
<p>Glass door parts</p>	<ul style="list-style-type: none"> • Wash with warm soapy water. • To remove grease from inner glass panels, use a proprietary oven cleaner spray or gel, leave to work for as long as recommended in the instructions, then wipe away and rinse. • Polish with a soft microfibre cloth. • Do not allow oven cleaners to come into contact with stainless steel, aluminium or chrome parts, shelves, shelf supports, door seals, heating elements, or fascias with printed markings. 	<ul style="list-style-type: none"> • Washing-up liquid. • Proprietary oven cleaner. • Microfibre cloths.

Area of appliance / material	Cleaning guidance	Example products
Grill compartment	<ul style="list-style-type: none"> • It is a good idea to leave the grill element on for a few minutes after finishing cooking to burn off any grease on the heating element. • Do not leave a grill-pan containing grease under the grill element during this procedure. • Once the grill compartment has cooled down, it can be wiped down with a damp wrung-out cloth which has been soaked in warm soapy water. • Wave-shaped sponges can be useful for cleaning chrome shelves, grill pan trivets, and for cleaning the roof of the grill cavity, getting in between the grill element. 	<ul style="list-style-type: none"> • Washing-up liquid. • Wave-shaped sponges.
Rubber door seals	<ul style="list-style-type: none"> • Clean with warm soapy water. • Do not attempt to clean fibreglass door seals on pyrolytic ovens. 	<ul style="list-style-type: none"> • Washing-up liquid.
Steel - fascia control panels, electric hotplate frames, door fronts	<ul style="list-style-type: none"> • Clean steel parts with warm soapy water and a soft sponge. • Do not scrub fascias / control panels as the markings could start to wear away. • Rinse with warm water and a soft cloth. • Polish dry with a microfibre cloth. 	<ul style="list-style-type: none"> • Washing-up liquid. • Microfibre cloths.

APPLIANCE MAINTENANCE

CHANGING THE LIGHTBULB

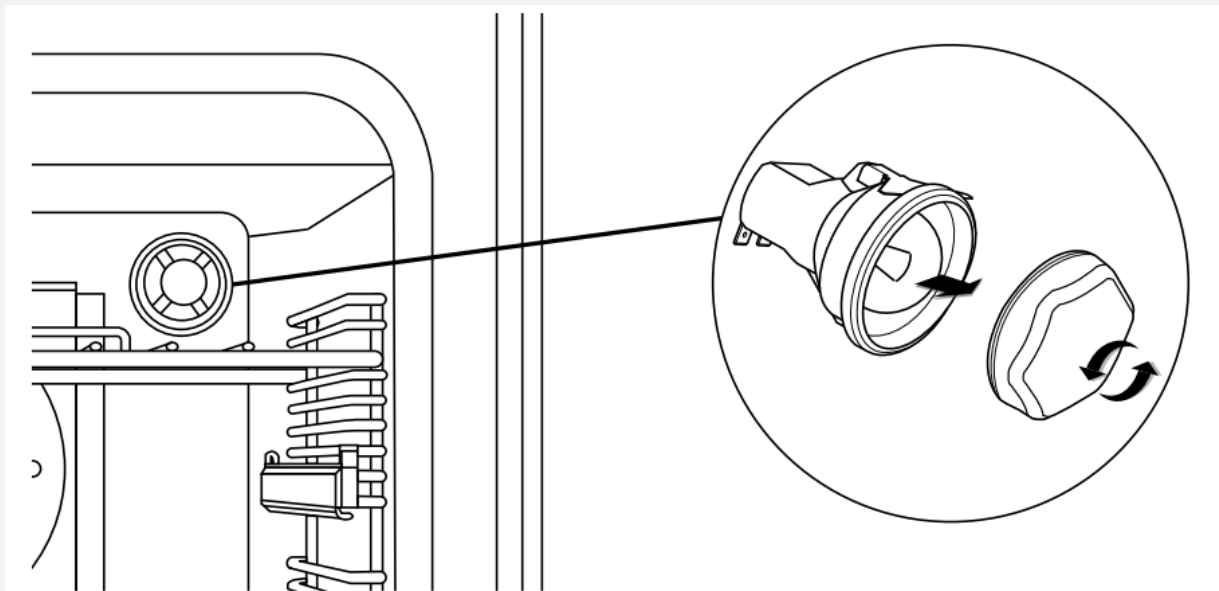

1. Switch the cooker off at the wall. Remove the oven shelves, grill pan and any other trays as appropriate.
2. Unscrew the lens cover by turning anticlockwise.
3. Remove the old bulb and replace it with a new one. Handle the new bulb with a piece of kitchen paper as skin oils can damage halogen bulbs.
4. Replace the lens cover and put the oven shelves and trays back.



Warning

Switch off the power before you change the light bulb.



Note

Not all appliances have the same number and type of bulbs. Before you replace your bulb, check to see what type you have. Usually a 25 watt G9 halogen capsule bulb - part number 082650920.

Please remember that bulbs are not covered by the manufacturer's warranty.

OVEN SHELVES

The oven shelves use anti-tip notches to prevent them being accidentally pulled out fully with hot food and cookware on them, to help prevent accidents.

Shelves With Anti-Tip Notches.

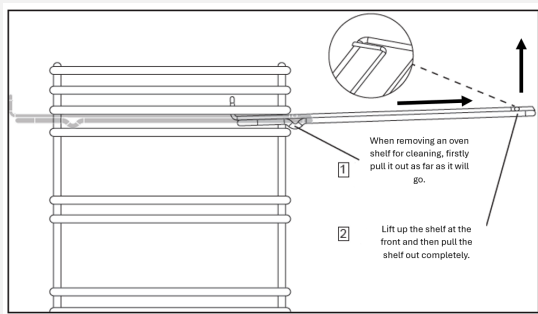

To remove the shelves fully, for cleaning or to reposition them, pull the shelf out as far as it will go, then lift upwards at the front to pull out fully.

Shelves.

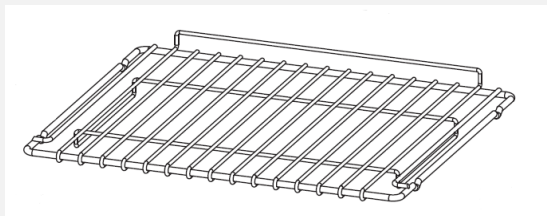

When inserting the shelves into the shelf guides, ensure that the upstand piece is at the back of the shelf and is pointing upwards. (Not all shelf types have an upstand).

The anti-tip notches should always be pointing downwards, and should be towards the back of the shelf.

Shelf Guides.

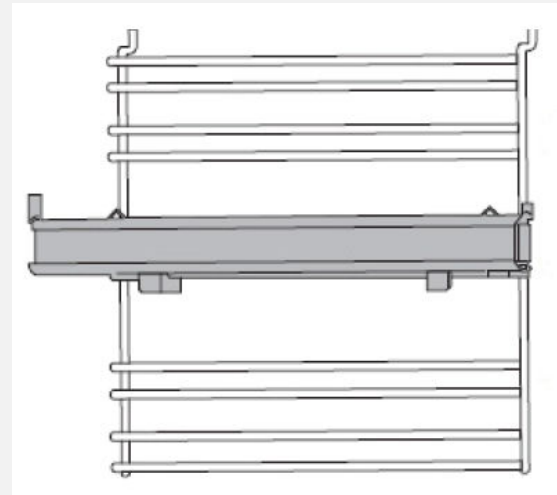

Caution

Each shelf guide position consists of an upper and a lower wire. Please insert the shelf between the two wires, and not sitting on top of the upper wire.

REMOVING AND REPLACING SHELF GUIDES

- The shelf guides have lugs which attach into holes on the side of the oven cavity.
- The shelf guide wires at the bottom clip under retainers to keep the shelf guides in position.
- The retainers look like small cotton reels or bobbins which are attached to the side of the oven cavity,

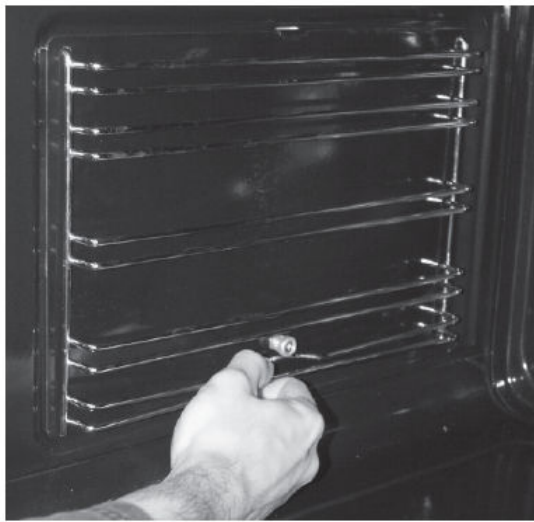
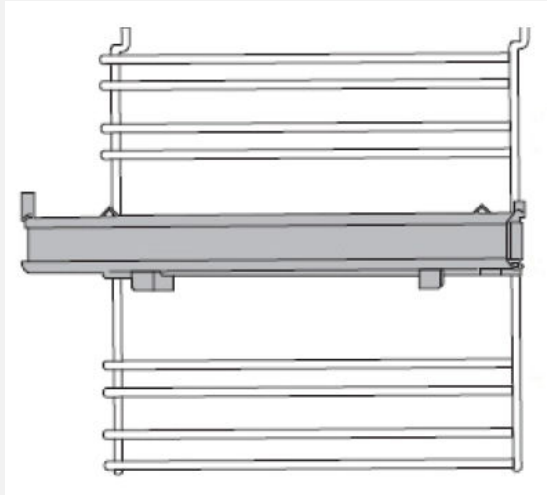

- To remove the shelf guides for cleaning, firstly please remove the shelves, grill pan and air fry tray as appropriate.
- Gently stretch the shelf guide wire at the bottom, pulling down and away from the retainer to release the wire from the retainer.
- The shelf guide can then be pulled away from the side of the oven cavity. The shelf guide lugs will come out of the holes in the side of the cavity.
- The shelf guide is replaced in the opposite manner.
- Insert the lugs into the holes on the side of the oven cavity.
- Then gently stretch the guide wire at the bottom to loop it under the retainer.

REMOVING AND RE-FITTING CONTROL KNOBS, SPRINGS AND BEZELS

- The control knob assembly consists of the knob at the front, a bezel with markings around the knob, and a spring between the knob and the bezel.
- For cleaning, the bezels can be carefully slid forward to allow easy cleaning of the fascia control panel behind with a cloth.
- The bezels will spring back into position when you let go.
- For more thorough cleaning, the knobs, bezels and springs can be removed as follows.
- Firstly, please take a moment to note the positions of the different types of bezels on the cooker, take some photographs or have the appliance user guide handy. This will help you to replace the controls in the correct positions after cleaning.
- Ensure that all of the control knobs are in the 'off' position, and that the cooker is turned off at the wall.
- Push the control knob in towards the bezel.
- Then, holding the knob and bezel together, pull them both towards you and off the cooker spindle.
- Be careful not to lose the spring, or the small silver clip which is inside the control knob shaft.
- To re-fit the control knobs, bezels and springs after cleaning, please follow these steps:
 - Place the bezel face up on a surface.
 - The flat side of the D-shaped hole and the printed dot for the 'off' position should be at the top.
 - Place the spring over the hole in the middle of the bezel.
 - Ensure that the knob is facing upwards, with the indicator mark at the top.
 - Place the knob firmly over the spring, ensuring that the shaft on the back of the knob is located through the middle of the spring.
 - The flat side of the D-shaped shaft at the back of the knob should be lined up with the flat side of the D-shaped hole in the middle of the bezel.

- **Press down on the knob to push it into the bezel and keep it held down.**
- **The flat side of the D-shaped shaft at the back of the knob should be facing upwards.**
- **While holding the knob and bezel together, push the control knob assembly on to the cooker spindle.**
- **The cooker spindle is also D-shaped, so ensure that the flat side of the D-shaped shaft at the back of the knob is aligned with the flat side of the spindle.**
- **The control knob assembly has now been correctly installed and the controls can be used as normal.**

FAQs

For up-to-date frequently asked questions,
please visit our Range Cooker FAQ page at:

[Range Cooker FAQs](#)

KEY PARTS AND OPTIONAL ACCESSORIES

Please see below for useful part numbers for your cooker, in case you require a replacement part or wish to purchase additional shelves or optional telescopic sliders, for example.

For any queries relating to parts missing on delivery of a new cooker, or relating to replacement parts during the manufacturer's warranty period, please contact our customer

care team using the telephone number on the back cover.

To purchase additional shelves, sliders, consumables or parts outside of the manufacturer's warranty period, please refer to the Spare Parts section of our website - the website address is on the back cover.

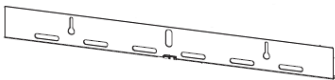
Part	Part Number	Notes
 <p>Air fry basket</p>	094108700	<p>Quantity 1 is supplied with the cooker.</p> <p>Used in the main fanned oven.</p>
Clip-in door seal - main oven (bottom-left)	094103502	Clips in - does not usually require an engineer service visit.
Clip-in door seal - top oven (top-left)	094103500	Clips in - does not usually require an engineer service visit.
Clip-in door seal - tall right hand oven	094103503	Clips in - does not usually require an engineer service visit.
 <p>Decorative cover plinth - black</p>	094108206 for 90cm wide cookers	<p>Quantity 1 is supplied with the cooker.</p> <p>Only required to be fitted if the cooker feet are fully extended to accommodate taller worktops.</p>

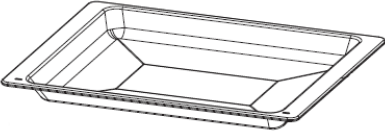
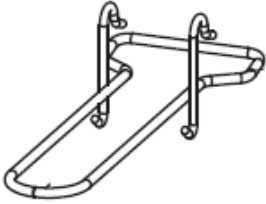
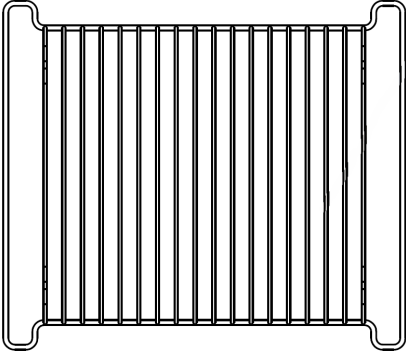
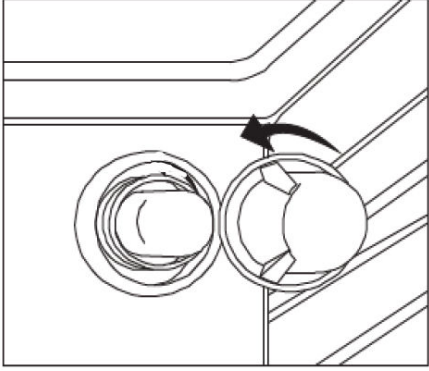
Part	Part Number	Notes
 <p data-bbox="209 495 400 528">Deep grill pan</p>	<p data-bbox="699 253 858 286">094106100</p>	<p data-bbox="1007 253 1369 320">Quantity 1 is supplied with the cooker.</p> <p data-bbox="1007 360 1369 544">Can be used in the top grill or main fanned oven. (Cannot be used in the tall right-hand oven on 90cm models).</p>
 <p data-bbox="209 920 424 954">Grill pan handle</p>	<p data-bbox="699 566 847 600">094111300</p>	<p data-bbox="1007 566 1369 633">Quantity 1 is supplied with the cooker.</p>
 <p data-bbox="209 1397 408 1431">Grill pan trivet</p>	<p data-bbox="699 969 858 1003">094117000</p>	<p data-bbox="1007 969 1369 1037">Quantity 1 is supplied with the cooker.</p>
 <p data-bbox="209 1872 352 1906">Lamp bulb</p>	<p data-bbox="699 1447 863 1480">082650920</p>	<p data-bbox="1007 1447 1369 1514">Type - 25 watt G9 halogen capsule bulb.</p> <p data-bbox="1007 1554 1350 1700">Please note that replacement bulbs are not covered under the manufacturer's warranty.</p>

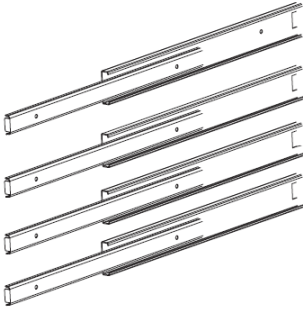
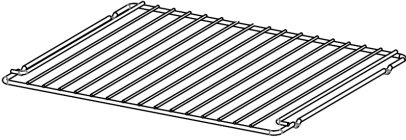
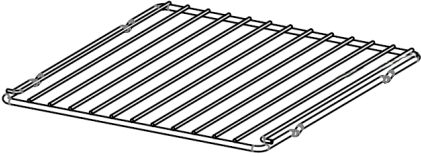
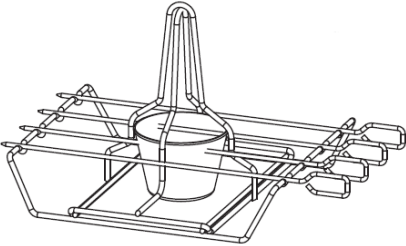
Part	Part Number	Notes
 <p>Telescopic Sliders</p>	<p>Left hand side slider: 1 x 094109802</p> <p>Right hand side slider: 1 x 094109803</p> <p>You need 1 x 094109802 and 1 x 094109803 to make a pair.</p>	<p>Available to buy as an optional extra.</p> <p>Can be used in the main fanned oven or the tall right-hand fanned oven.</p> <p>Do not attempt to use them in positions where the shelf guide wires are close together.</p>
 <p>Shelf (50)</p>	<p>094108600</p>	<p>Quantity 3 are supplied with the cooker.</p> <p>Can be used in the top grill or main fanned oven.</p>
 <p>Shelf (40)</p>	<p>094108602</p>	<p>Quantity 4 are supplied with the cooker.</p> <p>Used in the tall right-hand fanned oven.</p>
 <p>Steam & Infuse Kit (Vertical roasting system)</p>	<p>094109600</p>	<p>Can be purchased as an optional extra.</p> <p>Can be used in the main fanned oven (in true fan oven mode). (Cannot be used in the tall right-hand oven on 90cm models).</p>

LOCATING THE MODEL AND SERIAL NUMBERS

- Please open the bottom-left oven door to locate the data badge on the front frame, close to the door seal.
- Please quote the model number and serial number should you ever require an engineer service visit or need to order spare parts.
- The model number (also known as the SKU number) is 9 digits long, beginning with 44...
- The serial number is printed as a string of 17 digits - the first 8 digits are the serial number and the remaining 9 digits are the model number.

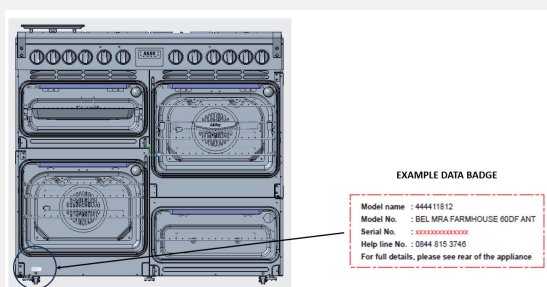

Tip

It is a good idea to take a photo of the data badge or to make a written note of the model number and serial number on your quick start guide, especially if the decorative cover plinth is going to be fitted to accommodate taller worktops.

TECHNICAL DATA



Warning
This cooker must be earthed.

Data badge	Lower part of the front frame, and on the back of the appliance.
Appliance class	Class 1 - freestanding cooker
Electrical supply	220 - 240V ~ 1N ~ 50 Hz or 380 - 415V ~ 3N ~ 50 Hz
Load	17315W (Induction Unit 10200W)
Standard Oven Light	25W

Hob Top Hotplate	Electrical Supply	Zone Load (W)
Electric	230V	Left hand front 1800W (2100W Boost)
		Left hand rear 1800W (2100W Boost)
		Right hand front 1200W (1500W Boost)
		Right hand rear 1800W (2100W Boost)
		Centre 2300W (3000W Boost)
		N/A

Appliance Electrical Supply	Oven Cavity & Function Load (W)
230V	Left-hand main oven: Fanned- Air Fry 3166W
	Tall Oven: Fanned Oven- Single 2339W
	Left hand Top cavity: Single Grill 1561W

ENERGY DATA TABLE

Regulation (EU) 66/2014:

Model Identification: Belling 90cm Electric Induction (Touch Controls) : All Models	
Brand:	Belling
Size:	90cm

Energy Efficiency For Oven

Oven	Cavity 1	Cavity 2	Cavity 3 (if applicable)
Mass of the appliance (M): 101.0 kg			
Number of cavities: 2			
Location:	Bottom-left	Right-hand-side	N/A
Type of oven:	Electric Oven	Electric Oven	N/A
Heat source per cavity:	Electricity	Electricity	N/A
Volume per cavity (V):	60 Litres	81 Litres	N/A
Energy consumption (electricity consumed) per cycle in conventional mode (EC_{electric cavity}):	N/A	N/A	N/A
Energy consumption (electricity consumed) per cycle in fan-forced convection mode (EC_{electric cavity}):	0,74 kWh	0,83 kWh	N/A
Energy efficiency index per cavity (EEI_{cavity}):	92,5	93,3	N/A
Energy efficiency class:	A	A	N/A

Energy Efficiency For Hob

Hob	
Type of hob:	Electric
Number of cooking zones and/or areas:	5

Hob	
Heating technology:	Induction cooking areas and zones

Electric Zone:	Location:	Useful surface area per electric heated cooking zone:	Energy consumption per cooking zone or area (EC_{electric cooking}):
Zone 1	Front-left	21.5cm wide by 19.0cm long	192.0 Wh/kg
Zone 2	Back-left	21.5cm wide by 19.0cm long	193.2 Wh/kg
Zone 3	Centre	23.0cm diameter	191.1 Wh/kg
Zone 4	Back-right	20.0 cm diameter	192.7 Wh/kg
Zone 5	Front-right	Front-right	194.0 Wh/kg
Zone 6	Left-hand bridged area	21.5cm wide by 38.0cm long	199.0 Wh/kg

Energy consumption for the hob (EC_{electric hob}):	193.7 Wh/kg
--	--------------------

Energy consumption measured in accordance with EN 60350-1 and EN 60350-2

ENERGY SAVING TIPS FOR HOBS



Tip

Use pans with flat bases.

Use pans which are suitably-sized for the size of the cooking zone.

Use pans with lids.

Minimise the amount of liquid or fat when cooking.

When liquid starts boiling, reduce the power level to a simmer.

Using a pan with a base diameter a little larger than the diameter of the cooking zone gives the most energy-efficient cooking results.

ENERGY SAVING TIPS FOR OVENS



Tip

Cook separate meals together, if possible.

Keep the pre-heating time as short as possible.

Do not elongate the cooking time.

Do not forget to turn the oven off at the end of cooking.

Do not open the oven door during the cooking process.

If the oven has a programmable timer, use the timer to switch the oven heating off at the end of cooking.

If cooking for longer periods, turning the oven heating off 10 minutes before the end of cooking can save energy by using the residual heat to finish the cooking process. Always ensure that food is thoroughly cooked through.

SERVICE CONTACT DETAILS

Ireland	Tel: +353 (0) 1 8428222 Service e-mail: serviceireland@glendimplex.com Spare parts enquiries e-mail: sparesireland@glendimplex.com www.glendimplexireland.com Glen Dimplex Ireland UC, Airport Road, Cloghran, Co. Dublin, K67 DT89
United Kingdom	Stoves Service Tel: +44 (0) 344 815 3740 www.stoves.co.uk Belling Service Tel: +44 (0) 344 815 3746 www.belling.co.uk Glen Dimplex Home Appliances, Element, Temple Court, Risley, Warrington, WA3 6GD

This document relates to these models:

Model Number:	Model Description:
444411795	BEL RCA COOKCENTRE 90Ei BLK
444411796	BEL RCA COOKCENTRE 90Ei STA
444411822	BEL RCA FARMHOUSE 90Ei ANT
444411823	BEL RCA FARMHOUSE 90Ei BLK
444411824	BEL RCA FARMHOUSE 90Ei CRM

**Glen Dimplex Home Appliances, Element, Temple Court, Risley,
Warrington, WA3 6GD.**

0344 815 3746

www.belling.co.uk

GDHA Part Number: 094113801

