

# Hotpoint

## Double Oven

### User Manual

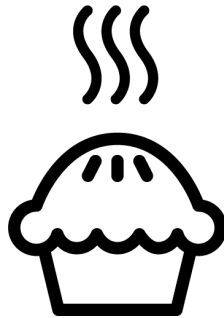

HDE6IDC2SA

285381084/ EN/ R.AA/ 06/03/2025 08:57  
7734986456



## Welcome!

---

Dear Customer,

Thank you for choosing the Hotpoint product. We want your product, manufactured with high quality and technology, to offer you the best efficiency. Therefore, carefully read this manual and any other documentation provided before using the product.

Keep in mind all the information and warnings stated in the user's manual. This way, you will protect yourself and your product against the dangers that may occur.

Keep the user's manual. If you give the product to someone else, give the manual with it. The warranty conditions, usage and troubleshooting methods for your product are provided in this manual.

### The symbols and their descriptions in the user's manual:



Hazard that may result in death or injury.



Important information or useful usage tips.



Read the user's manual.



Hot surface warning.

**NOTICE** Hazard that may result in material damage to the product or its environment.

**Beko Europe Management Srl**

Via Varesina 204, 20156 Milano, Italy

## Table of Contents

<b>1 Safety Instructions</b> .....	<b>4</b>
1.1 Intended Use.....	4
1.2 Child, Vulnerable Person and Pet Safety .....	4
1.3 Electrical Safety.....	5
1.4 Transportation Safety .....	7
1.5 Installation Safety.....	7
1.6 Safety of Use .....	8
1.7 Temperature Warnings .....	9
1.8 Accessory Use.....	9
1.9 Cooking Safety .....	10
1.10 Induction .....	11
1.11 Steam System .....	12
1.12 Maintenance and Cleaning Safety .....	12
<b>2 Environmental Instructions</b> .....	<b>12</b>
2.1 Waste Directive.....	12
2.1.1 Compliance with the WEEE Directive and Disposing of the Waste Product .....	12
2.2 Package Information.....	14
2.3 Recommendations for Energy Saving.....	14
<b>3 Your product</b> .....	<b>14</b>
3.1 Product Introduction .....	14
3.1.1 Cooking Section.....	15
3.1.2 Hob section .....	15
3.2 Introduction of the oven control panel .....	15
3.3 Oven operating functions.....	16
3.4 Product Accessories.....	17
3.5 Use of Product Accessories .....	17
3.6 Technical Specifications.....	20
<b>4 Installation</b> .....	<b>21</b>
4.1 Right place for installation.....	21
4.2 Electrical connection.....	22
4.3 Placing the product .....	23
<b>5 First Use</b> .....	<b>23</b>
5.1 First Timer Setting.....	23
5.2 Initial Cleaning .....	24
<b>6 How to use the hob</b> .....	<b>24</b>
6.1 General information on hob usage.....	24
6.2 Hob control unit.....	27

<b>7 Using the Oven</b> .....	<b>32</b>
7.1 General Information on Using the Oven .....	32
7.2 Using the bottom section of the oven .....	32
7.2.1 Settings.....	34
7.3 Using the upper section of the oven .....	35
7.4 Steam Assisted Cooking.....	36
<b>8 General Information About Cooking</b> .....	<b>37</b>
8.1 General information about cooking with hob.....	37
8.2 General Warnings About Baking in the Oven.....	37
8.2.1 Pastries and oven food.....	38
8.2.2 Meat, Fish and Poultry .....	40
8.2.3 Grill .....	41
8.2.4 Steam assisted cooking .....	42
8.2.5 Test foods.....	43
<b>9 Maintenance and Cleaning</b> .....	<b>44</b>
9.1 General Cleaning Information....	44
9.2 Cleaning Accessories.....	45
9.3 Cleaning the hob.....	45
9.4 Cleaning the Control Panel .....	45
9.5 Cleaning the inside of the oven (cooking area).....	45
9.6 Easy Steam Cleaning .....	46
9.7 Cleaning The Drop Down Oven Door(s) .....	47
9.8 Removing the Inner Glass of The Upper Oven Door .....	48
9.9 Cleaning the Oven Lamp .....	48
<b>10 Troubleshooting</b> .....	<b>49</b>



## 1 Safety Instructions

---

- This section includes the safety instructions necessary to prevent the risk of personal injury or material damage.
- If the product is handed over to someone else for personal use or second-hand use purposes, the user's manual, product labels and other relevant documents and parts should also be given.
- Our company shall not be held responsible for damages that may occur if these instructions are not observed.
- Failure to follow these instructions shall void any warranty.
- Use original spare parts and accessories only.
- Do not repair or replace any component of the product unless it is clearly specified in the user's manual.
- Do not make technical modifications on the product.



### 1.1 Intended Use

- This product is designed to be used at home. It is not suitable for commercial use.
- Do not use the product in gardens, balconies or other outdoors. This product is intended to be used in households and

in the staff kitchens of shops, offices and other working environments.

- This appliance is intended for use up to a maximum height of 2500 meters above sea level.
- **CAUTION:** This product should be used for cooking purposes only. It should not be used for different purposes, such as heating the room.
- The oven can be used to defrost, bake, fry and grill food.
- This product should not be used for plate heating, drying by hanging towels or clothes on the handle.



### 1.2 Child, Vulnerable Person and Pet Safety

- This product can be used by children 8 years of age and older, and people who are underdeveloped in physical, sensory or mental skills, or who have lack of experience and knowledge, as long as they are supervised or trained about the safe use and hazards of the product.
- Children should not play with the product. Cleaning and user maintenance should not be performed by children unless there is someone overseeing them.

- This product should not be used by people with limited physical, sensory or mental capacity (including children), unless they are kept under supervision or receive the necessary instructions.
- Children should be supervised to ensure that they do not play with the product.
- Electrical products are dangerous for children and pets. Children and pets must not play with, climb on, or enter the product.
- Do not put objects that children may reach on the product.
- Turn the handle of the pots and pans to the side of the counter so that children cannot grab and burn.
- **CAUTION:** During use, the accessible surfaces of the product are hot. Keep children away from the product.
- Keep the packaging materials out of the reach of children. There is a hazard of injury and suffocation.
- When the door is open, do not put any heavy objects on it or allow children to sit on it. You may cause the oven to tip over or damage the door hinges.
- Before discarding worn out and useless products:
  1. Unplug the power plug and remove it from the socket.
  2. Cut off the power cable and disconnect it with the plug from the product.
  3. Take precautions to prevent children from entering the product.
  4. Do not allow children to play with product when it is in idle mode.



### 1.3 Electrical Safety

- Plug the product into a grounded outlet protected by a fuse that matches the current ratings indicated on the type label. Have the grounding installation made by a qualified electrician. Do not use the product without grounding in accordance with local / national regulations.
- The plug or the electrical connection of the appliance shall be in an easily accessible place. If this is not possible, there should be a mechanism (fuse, switch, key switch, etc.) on the electrical installation to which the product is connected, in compliance with the electrical regulations and separating all poles from the network.

- Unplug the product or switch off the fuse before repair, maintenance and cleaning.
  - Plug the product into an outlet that meets the voltage and frequency values specified on the type label.
  - (If your product does not have a mains cable) only use the connecting cable described in the "Technical specifications" section.
  - Do not jam the power cable under and behind the product. Do not put a heavy object on the power cable. The power cable should not be bent, crushed, and come into contact with any heat source.
  - Make sure that the power cable is not jammed while putting the product to its place after assembly or cleaning.
  - The rear surface of the oven gets hot when it is in use. The power cables must not touch the rear surface of the product. Otherwise it might get damaged.
  - Do not jam the electric cables into the oven door and do not pass them over hot surfaces. Otherwise, cable insulation may melt and cause fire as a result of short circuit.
  - Use original cable only. Do not use cut or damaged cables.
  - Do not use an extension cord or multi-plug to operate your product.
  - Contact the importer or the authorized service centre if the length of the power line is inadequate.
  - Portable power sources or multiple plugs may overheat and catch fire. Keep multiple plugs and portable power sources away from the product.
  - If the power cable is damaged, it must be replaced by the manufacturer, an authorized service or a person to be specified by the importer company in order to prevent possible dangers.
  - **CAUTION:** Before replacing the oven lamp, be sure to disconnect the product from the mains supply to avoid the risk of electric shock. Unplug the product or turn off the fuse from the fuse box.
- If your product has a power cable and plug:
- Never put the product plug into a broken, loose, or out-of-socket plug. Make sure the plug is fully inserted into the socket. Otherwise the connections may overheat and cause a fire.

- Avoid inserting the device into plugs that are greasy, unclean, or potentially exposed to water (such as those near a worktop where water may escape). Otherwise there is a risk of short circuit and electrocution.
- Never touch the plug with wet hands!
- Pull the plug out of the socket using the plug's body rather than the cord itself.

#### **1.4 Transportation Safety**

- Disconnect the product from the mains before transporting the product.
- The product is heavy, carry the product with at least two people.
- Do not use the door and / or handle to transport or move the product.
- Do not place items on the appliance. Carry the appliance vertically.
- When you need to transport the product, wrap it with bubble wrap packaging material or thick cardboard and tape it tightly. Secure the moving parts of the product firmly to prevent damage.

- Before the product is installed, check the product for any damage after transport. Contact the importer or the authorized service centre if damaged.

#### **1.5 Installation Safety**

- Before beginning the installation, de-energize the power line to which the product will be connected by turning off the fuse.
- Always wear protective gloves during transport and installation. Otherwise there is a risk of injury from sharp edges!
- Before the product is installed, check the product for any damage. Do not have it installed if the product is damaged.
- Never place the product on a carpet-covered floor. Product Otherwise, lack of airflow beneath the product will cause electrical parts to overheat. This will cause problems with your product.
- The product should be placed directly on a clean, flat and hard surface. It should not be placed on a plinth or bed plate. Products must not be placed on cardboard or plastic plates.

- Direct sunlight and heat sources, such as electric or gas heaters, must not be present in the area where the product is installed.
- Keep the surroundings of all ventilation ducts of the product open.
- Do not install the product near a window. There is a risk that the hob flame will ignite curtains and flammable materials around the hob. When you open the window, hot cookware may tip over.
- Do not install the product near a window. When you open the window, hot cookware may tip over.
- To avoid overheating, product installation should not be carried out behind decorative covers.
- In cases where a gas hose/ pipe or plastic water pipe is situated behind the designated installation area for the product, it is imperative to guarantee that there is no contact between the product and these utility lines. Otherwise the hose/pipe may be crushed.
- If there is a socket behind the place where the product will be installed, it must be ensured that the product does not

come into contact with the socket nor with the plug plugged into the socket.

- There should be no gas hose, plastic water pipe and socket on the back or side wall of the place where the product will be installed. Otherwise, they may be deformed by the heat effect when the hob is operated and may create a safety risk.



## 1.6 Safety of Use

- Ensure that the appliance is switched off after every use.
- If you will not use the product for a long time, unplug it or turn off the power from the fuse box.
- Don't use the product if it breaks down or gets damaged while being used. Disconnect the product from the electricity. Contact the importer or the authorized service centre.
- Do not use the product if the front door glass is removed or cracked. Otherwise there is a risk of injury and environmental damage.
- **CAUTION:** If the hob surface is cracked, disconnect the product from the mains to avoid the risk of electric shock.
- **CAUTION:** If the hob glass surface is broken:



Switch off all gas and (if applicable) electric hotplates. Disconnect the product from the electricity.

- Do not touch the appliance surface.

- Do not use the appliance.

- Do not step on the appliance for any reason.
- Never use the product when your judgement or coordination is impaired by the use of alcohol and/or drugs.
- Flammable objects must not be kept in and around the cooking area. Otherwise, these may lead to fire.
- The oven handle is not a towel dryer. When using the product, do not hang towels, gloves or similar textiles on the handle.
- The hinges of the product door move when opening and closing the door and might jam. When opening / closing the door, do not hold the part with the hinges.
- This product is not suitable for use with a remote control or an external clock.

### 1.7 Temperature Warnings

- **CAUTION:** When the product is in use, the product and its accessible parts will be hot. Care should be taken to avoid

touching the product and heating elements. Children under 8 years of age should be kept away from the product unless constantly supervised.

- Do not place flammable / explosive materials near the product, as the surfaces will be hot while it is operating.
- Keep your distance when opening the oven door during or at the end of cooking. The steam may burn your hand, face and/or eyes.
- During operation the product is hot. Care should be taken to avoid touching hot parts, inside of the oven and heating elements.
- Always wear heat-resistant oven gloves when handling the product.
- **CAUTION:** Danger of fire: Do not store items on the cooking surfaces.

### 1.8 Accessory Use

- It is important that the wire grill and tray are placed properly on the wire shelves. For detailed information, refer to the section "**Usage of accessories**".

- Close the oven door after pushing the accessories completely into the cooking space, otherwise they may hit the door glass and damage it.
- **CAUTION:** Use only hob guards designed by the manufacturer of the cooking appliance or indicated by the manufacturer of the appliance in the instructions for use as suitable or hob guards incorporated in the appliance. The use of inappropriate guards can cause accidents.
- Food residues in the cooking area., such as oil, can ignite. Clean these residues before cooking.
- Food Poisoning Hazard: Do not let food sit in oven for more than 1 hour before or after cooking. Otherwise it may cause food poisoning or diseases.
- Do not heat closed tins and glass jars in the oven. The pressure that would build-up in the tin/jar may cause it to burst.

## 1.9 Cooking Safety

- **CAUTION:** The cooking process must be observed. Short-term cooking processes must be constantly observed.
  - **CAUTION:** In solid or liquid oil cooking, it is dangerous to leave the hob unattended, which may cause a fire. NEVER try to extinguish the fire with water; disconnect the product from the mains, and then cover the flames with a cover or fire cloth (etc.).
  - Be careful when using alcoholic drinks in your dishes. Alcohol evaporates at high temperatures and may cause fire since it can ignite when it comes into contact with hot surfaces.
  - Do not place baking trays, dishes or aluminium foil directly onto the bottom of the oven. The accumulated heat might damage the bottom of the oven.
- Be mindful of the following precautions when using greasy parchment paper or similar materials:
- Place the greaseproof paper in a cookware or on the oven accessory (tray, wire grill, etc.) with food and place it in the preheated oven.
  - To prevent the risk of touching the oven heating elements and obstructing the flow of hot air, remove any excess parts of greaseproof paper that hang from accessories or containers. Do not use greaseproof

paper at oven temperatures higher than the maximum usage temperature specified by the manufacturer. Never place greaseproof paper on the oven base.

- Do not place it on top of accessories during preheating.
- Always press down with a plate or similar object to prevent the material from flying around due to the air circulation inside the oven.
- Only cover the necessary surface inside the tray.
- After each use, the tray should be cleaned, and any greaseproof paper or similar materials used in the tray should be replaced. Otherwise, liquids dripping onto the tray can cause smoking or even ignite flames.
- An air flow is generated when the product lid is opened. Greaseproof paper can come into contact with heating elements and ignite.
- When using a grilling rack for frying, a tray should be placed on the lower rack. Otherwise, the food oil and other components that drip onto the oven bottom can create heavy smoke and lead to flames.

- Food not suitable for grilling carries a fire hazard. Grill only food that is suitable for heavy grill fire. Do not place the food too far in the back of the grill. This is the hottest area and fatty foods may catch fire.

### **1.10 Induction**

- The electrically operated zones of your hob are equipped with advanced "Induction" technology. On the induction hob zones, which save time and energy, cookware suitable for induction cooking must be used; otherwise the hob zone will not work. For detailed information, see the section "Pot selection".
- Since the induction hob creates a magnetic field, it can have harmful effects for people who use devices such as pacemakers or insulin pumps.
- Close the zone from its control panel after use, do not rely on the pot sensor.
- Metal objects such as knives, forks, spoons and lids should not be placed on the hob surface as they will get hot.
- Do not store metal objects in drawers under the hob. During long and intensive use, the materials here may overheat.

- Do not place electronic products such as mobile phones, tablets, computers on the induction hob. Your appliance may be damaged.

### **1.11 Steam System**

- In steam assisted cooking, opening the door causes steam to escape, posing a risk of skin burn. Be careful when opening the door.
- If moisture remains in the oven after steam assisted cooking, it may cause corrosion. Let the oven dry by opening the oven door after cooking.
- Do not store wet food items in the oven for a long time.
- When removing the food after steam assisted cooking, hot liquid may flow from the accessories, be careful.
- Do not use distilled or filtered water. Use ready-made water only. Do not use flammable, alcoholic or particulate solutions instead of water.

- Do not use accessories that may corrode from steam while cooking.

### **1.12 Maintenance and Cleaning Safety**

- Wait for the product to cool before cleaning the product. Hot surfaces may cause burns!
- Never wash the product by spraying or pouring water on it! There is the risk of electric shock!
- Do not use steam cleaners to clean the product as this may cause an electric shock.
- Do not use harsh abrasive cleaners, metal scrapers, scouring pads, dish washing wire or bleach to clean the oven front door glass and oven top door glass (if equipped). These materials can cause glass surfaces to be scratched and broken.

## **2 Environmental Instructions**

### **2.1 Waste Directive**

#### **2.1.1 Compliance with the WEEE Directive and Disposing of the Waste Product**

This product complies with EU WEEE Directive (2012/19/EU). This product bears a classification symbol for waste electrical and electronic equipment (WEEE).



This product has been manufactured with high quality parts and materials which can be reused and are suitable for recycling. Therefore, do not dispose of the waste product with normal domestic and other wastes at the end of its service life. Take it to a collection point for the recycling of electrical and elec-

tronic equipment. You can ask your local administration about these collection points. Disposing of the appliance properly helps prevent negative consequences for the environment and human health.

---

### **Compliance with RoHS Directive:**

The product you have purchased complies with EU RoHS Directive (2011/65/EU). It does not contain harmful and prohibited materials specified in the Directive.

### **DISPOSAL OF PACKAGING MATERIALS**

The packaging material is 100% recyclable and is marked with the recycle symbol . The various parts of the packaging must therefore be disposed of responsibly and in full compliance with local authority regulations governing waste disposal.

### **DISPOSAL OF HOUSEHOLD APPLIANCES**

This appliance is manufactured with recyclable or reusable materials. Dispose of it in accordance with local waste disposal regulations. For further information on the treatment, recovery and recycling of household electrical appliances, contact your local authority, the collection service for household waste or the store where you purchased the appliance. This appliance is marked in compliance with European Directive 2012/19/EU, Waste Electrical and Electronic Equipment (WEEE) and with the Waste Electrical and Electronic Equipment regulations 2013 (as amended). By ensuring this product is disposed of correctly, you will help prevent negative consequences for the environment and human health. The  symbol on the product or on the accompanying documentation indicates that it should not be treated as domestic waste but must be taken to an appropriate collection center for the recycling of electrical and electronic equipment.

### **ENERGY SAVING TIPS**

Only preheat the oven if specified in the cooking table or your recipe. Use dark lacquered or enamelled baking trays as they absorb heat better.



Food requiring prolonged cooking will continue to cook even once the oven is switched off.

Make sure the oven door is closed completely when the appliance is turned on and keep it closed as much as possible while baking.

Cut the food into small, equally-sized pieces to reduce cooking time and save energy.

When the cooking time is long, over 30 minutes, reduce the oven temperature to the lowest setting during the last phase (3-10 minutes), based on the overall cooking time. The residual heat inside the oven will continue cooking the food.

Make the most of your hot plate's residual heat by switching it off a few minutes before you finish cooking.

The base of your pot or pan should cover the hot plate completely; a container that is smaller than the hot plate will cause energy to be wasted.

Cover your pots and pans with tight-fitting lids while cooking and use as little water as possible. Cooking with the lid off will greatly increase energy consumption.

Use only flat-bottomed pots and pans.

NOTE: People with a pacemaker or similar medical device should use care when standing near this induction cooktop while it is on. The electromagnetic field may affect the pacemaker or similar device. Consult your doctor, or the manufacturer of the pacemaker or similar medical device for additional information about its effects with electromagnetic fields of the induction cooktop.

### **DECLARATIONS OF CONFORMITY**

This appliance meets: Ecodesign requirements of European Regulation 66/2014; Energy Labelling Regulation 65/2014; Ecodesign for Energy-Related Products and En-

ergy Information (Amendment) (EU Exit) Regulations 2019, in compliance with the European standard EN 60350-1.

This product can contain halogen light (Energy Efficiency Class G) or LED light source (Energy Efficiency Class F).

## 2.2 Package Information

Packaging materials of the product are manufactured from recyclable materials in accordance with our National Environment Regulations. Do not dispose of the packaging waste with the household or other wastes, take it to the packaging material collection points designated by the local authorities.

## 2.3 Recommendations for Energy Saving

According to EU 66/2014, information on energy efficiency can be found on the product receipt supplied with the product. The following suggestions will help you use your product in an ecological and energy-efficient way:

## 3 Your product

In this section, you can find the overview and basic uses of the product's control panel. There may be differences in images and some features depending on the type of product.

- Defrost frozen food before baking.
- In the oven, use dark or enamelled containers that transmit heat better.
- If specified in the recipe or user's manual, always preheat. Do not open the oven door frequently during baking.
- Turn off the product 5 to 10 minutes before the end time of baking in prolonged bakings. You can save up to 20% electricity by using residual heat.
- Try to cook more than one dish at a time in the oven. You may cook at the same time by placing two cookers on the wire rack. In addition, if you cook your meals one after the other, it will save energy because the oven will not lose its heat.
- Use pots / pans with a size and lid suitable for the hob zone. Always choose the right size pot for your meals. More than necessary energy is needed for containers of the wrong size.
- Keep hob baking areas and pot bases clean. Dirt reduces the heat transfer between the baking area and the pot base.

## 3.1 Product Introduction

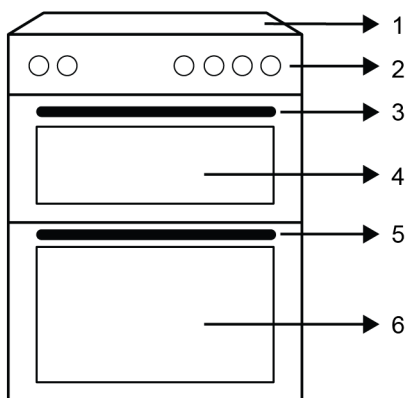

- 1 Hob section
- 2 Control panel
- 3 Handle (Upper cooking section)
- 4 Front door (Upper cooking section)
- 5 Handle (Bottom cooking section)

6 Front door (Bottom cooking section )

### 3.1.1 Cooking Section

#### Upper cooking section

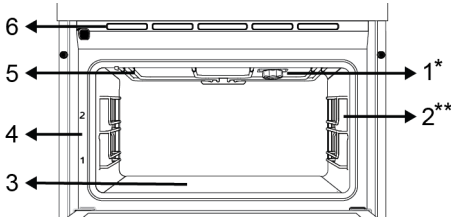

- 1 Lamp
- 2 Wire shelves
- 3 Lower heater (under the steel plate)
- 4 Shelf positions
- 5 Upper heater
- 6 Ventilation holes

\* Varies depending on the model. Your product may not be equipped with a lamp, or the type and location of the lamp may differ from the illustration.

\*\* Varies depending on the model. Your product may not be equipped with a wire rack. In the image, a product with wire rack is shown as an example.

#### Bottom cooking section

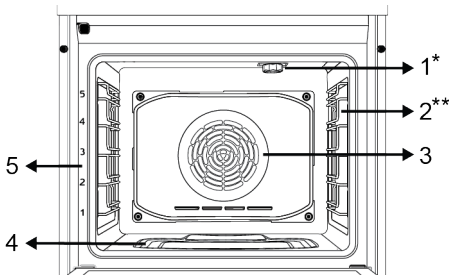

- 1 Lamp

- 2 Wire shelves
- 3 Fan motor (behind the steel plate)
- 4 Water pool for steam assisted cooking
- 5 Shelf positions

\* Varies depending on the model. Your product may not be equipped with a lamp, or the type and location of the lamp may differ from the illustration.

\*\* Varies depending on the model. Your product may not be equipped with a wire rack. In the image, a product with wire rack is shown as an example.

### 3.1.2 Hob section

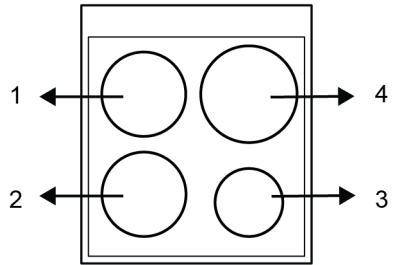

- 1 Rear left - Induction cooking zone
- 2 Front left - Induction cooking zone
- 3 Front right - Induction cooking zone
- 4 Rear right - Induction cooking zone

### 3.2 Introduction of the oven control panel

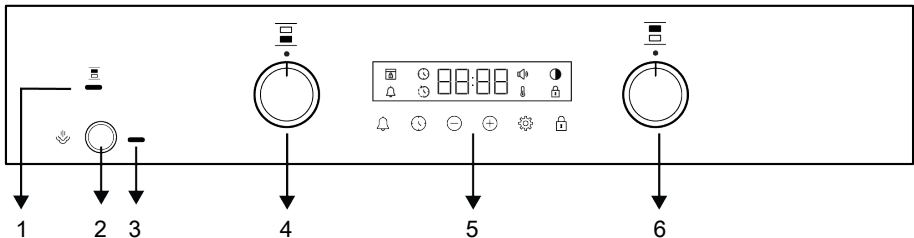

- 1 Thermostat lamp - Upper cooking section
- 3 Steam assisted cooking/cleaning lamp
- 5 Timer

If there are knob(s) controlling your product, in some models this/these knob(s) may be so that they come out when pushed (buried knobs). For settings to be made with these knobs, first push the relevant knob in and pull out the knob. After making your adjustment, push it in again and replace the knob.

### Oven control knobs

The bottom and upper cooking sections of your oven are controlled by separate oven control knobs. These knobs are indicated on the control panel.

### Oven inner temperature indicator - Bottom cooking section

You can understand the oven interior temperature of the lower cooking section of the oven from the temperature symbol on the timer display. The temperature symbol appears on the display when the cooking starts, and the temperature symbol disappears when the appliance reaches the set temperature. When the temperature inside the oven drops below the set temperature, the temperature symbol reappears.

### Oven inner temperature indicator -Upper cooking section

You can understand the oven interior temperature of the upper cooking section of the oven from the temperature lamp belonging to the upper cooking section. The thermostat lamp is located on the control panel. The thermostat lamp turns on when the product starts to operate, and the thermostat lamp turns off when it reaches the set temperature. When the temperature inside the oven drops below the set temperature, the thermostat lamp turns on again.

- 2 Steam assisted cooking/cleaning button
- 4 Lower cooking section symbol
- 6 Upper cooking section symbol

### Timer

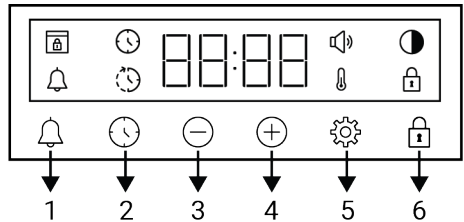

- 1 Alarm key
- 2 Time setting key
- 3 Decrease key
- 4 Increase key
- 5 Settings key
- 6 Key lock key

### Display symbols



- : Baking time symbol
- : Baking end time symbol \*
- : Alarm symbol
- : Brightness symbol
- : Key lock symbol
- : Temperature symbol
- : Volume level symbol
- : Door lock symbol \*

\*It varies depending on the product model. It may not be available on your product.

## 3.3 Oven operating functions

On the function table, the operating functions you can use in your oven and the highest and lowest temperatures that can be set for these functions are shown. The order of the operating modes shown here may differ from the arrangement on your product.



Function symbol	Function description	Temperature range (°C)	Description and use
	Operating with fan	-	The oven is not heated. Only the fan (on the back wall) operates. Frozen food with granules is slowly defrosted at room temperature, cooked food is cooled. The time required to defrost a whole piece of meat is longer than for foods with grains. Oven lamp also lights.
 	Easy steam cleaning	*	This function allows the dirt inside the oven (which has not been staying for a long time) to be softened and easily cleaned. See the cleaning section for easy steam cleaning.

### 3.4 Product Accessories

There are various accessories in your product. In this section, the description of the accessories and the descriptions of the correct usage are available. Depending on the product model, the supplied accessory varies. All accessories described in the user's manual may not be available in your product.



The trays inside your appliance may be deformed with the effect of the heat. This has no effect on the functionality. Deformation disappears when the tray is cooled.

#### Small tray

It is used for small portions. This oven tray is placed on top of the wire grill.

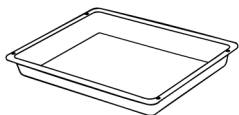

#### Wire grill

It is used for frying or placing the food to be baked, fried and stewed on the desired shelf.

#### On models with wire shelves :

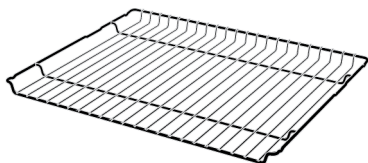

#### On models without wire shelves :

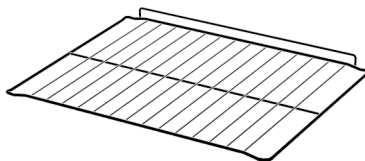

#### Wire grill in tray

By placing it in the tray (if provided), it is ensured that the oils flowing while grilling are collected in the tray and thus the contamination of the oven is prevented.

Wire grill in tray is not suitable for use in deep tray.

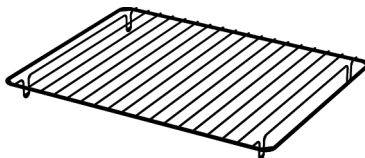

### 3.5 Use of Product Accessories

#### Cooking shelves

There are 5 levels of shelf position in the bottom cooking section, 2 levels of shelf position in the upper cooking section. You can also see the order of the shelves in the numbers on the front frame of the oven.

#### On models with wire shelves :

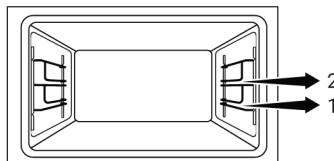

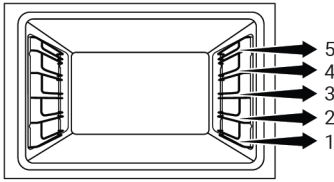

**On models without wire shelves :**

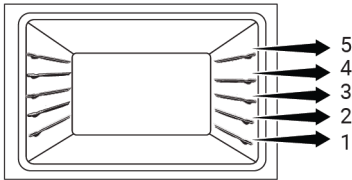
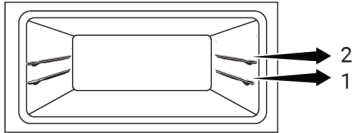

**Placing the wire grill on the cooking shelves**

**On models with wire shelves :**

It is crucial to place the wire grill on the wire side shelves properly. While placing the wire grill on the desired shelf, the open section must be on the front. For better cooking, the wire grill must be secured on the wire shelf's stopping point. It must not pass over the stopping point to contact with the rear wall of the oven.

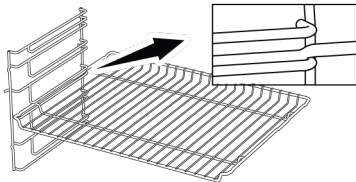

**On models without wire shelves :**

It is crucial to place the wire grill on the side shelves properly. The wire grill has one direction when placing it on the shelf. While placing the wire grill on the desired shelf, the open section must be on the front.

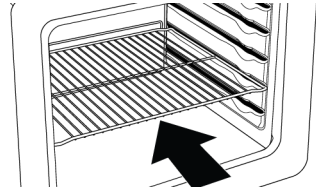

**Stopping function of the wire grill**

There is a stopping function to prevent the wire grill from tipping out of the wire shelf. With this function, you can easily and safely take out your food. While removing the wire grill, you can pull it forward until it reaches the stopping point. You must pass over this point to remove it completely.

**On models with wire shelves :**

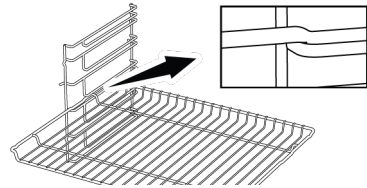

**On models without wire shelves :**

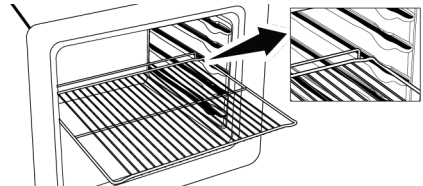

**Proper placement of the wire grill and tray on the telescopic rails-On models with wire shelves and telescopic models**

Thanks to the telescopic rails, trays or wire shelves can be easily installed and removed. Care should be taken to place the trays and wire shelves on the telescopic rails as shown in the figure below.

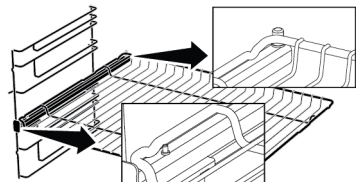

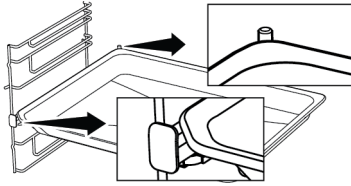

### 3.6 Technical Specifications

General specifications	
Product external dimensions (height/width/depth) (mm)	min. 900- max. 925 /600 /600
Voltage/Frequency	220-240 V ~ 50 Hz
Cable type and section used/suitable for use in the product	min. H05VV-FG 3 x 6 mm <sup>2</sup>
Fuse (min.)	40 A
Total power consumption (kW)	11,9
Oven type (Upper cooking section)	Conventional oven + Grill
Oven type (Bottom cooking section)	Fan oven

<b>Cooking zones</b>	
Front left	Induction cooking zone
Dimension	180 mm
Power	2000 W / Booster 2300 W
Front right	Induction cooking zone
Dimension	145 mm
Power	1600 W / Booster 1800 W
Rear left	Induction cooking zone
Dimension	180 mm
Power	2000 W / Booster 2300 W
Rear right	Induction cooking zone
Dimension	210 mm
Power	2000 W / Booster 2300 W

Basics: Information on the energy label of electrical ovens is given in accordance with the EN 60350-1 / IEC 60350-1 standard. Those values are determined under standard load with bottom-top heater or fan assisted heating (if any) functions.

Energy efficiency class is determined in accordance with the following prioritization depending on whether the relevant functions exist on the product or not: 1-Eco fan heating , 2-Fan Heating , 3-Fan assisted low grill , 4-Top and bottom heating.



Technical specifications may be changed without prior notice to improve the quality of the product.



Figures in this manual are schematic and may not exactly match your product.



Values stated on the product labels or in the documentation accompanying it are obtained in laboratory conditions in accordance with relevant standards. Depending on operational and environmental conditions of the product, these values may vary.

## 4 Installation

### General information

- Refer to the nearest Authorised Service Agent for installation of the product. Make sure that the electric and gas installations are in place before calling the Authorised Service Agent to have the product ready for operation. If not, call a qualified electrician and fitter to have the required arrangements made. The manufacturer shall not be held responsible for damages arising from procedures carried out by unauthorized persons which may also void the warranty.
- It is customer's responsibility to prepare the location the product shall be placed on and also have power and/or gas utility prepared.
- The rules specified in local standards about electrical and/or gas installations (legal rules on installation) shall be followed during product installation.
- Check for any damage on the appliance before the installation.

### 4.1 Right place for installation

- Place the product on a hard surface because of the air ducts under the product. It must not be placed onto a base or a pedestal. The feet of the product should not dip on soft surfaces, e.g. carpet, etc.
- The kitchen floor must be able to carry the weight of the appliance plus the additional weight of cookware and bakeware and food.
- This product is a class 1 device according to EN 30-1-1 standard. It can be placed adjacent to the kitchen walls, kitchen furniture or any other product in any dimension from behind and one edge. The kitchen furniture or equipment on the other side may only be of the same size or smaller.
- It can be used with cabinets on either side but in order to have a minimum distance of 400mm above hotplate level al-

low a side clearance of 65mm between the appliance and any wall, partition or tall cupboard.

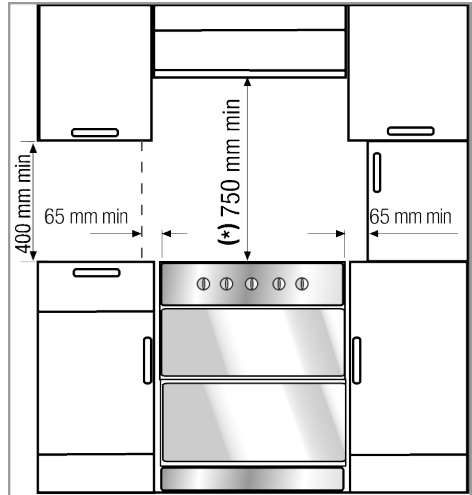

- It can also be used in a free standing position. Allow a minimum distance of 750 mm above the hob surface.
- If a cooker hood is to be installed above the cooker, refer to the instructions of the manufacturer of the cooker hood regarding installation height (min. 650 mm).
- Any kitchen furniture next to the appliance must be heat-resistant (100 °C min.).

### Anti-tip stability device

The product should be secured against losing its balance and falling by using the anti-tip stability device supplied with your product.

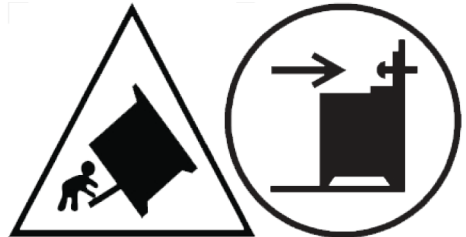

In order to prevent tipping of the appliance, this stabilizing means must be installed. Refer to the instructions for installation.

1. Draw a straight vertical line from the center of the back wall of the area where you will place the product.
2. Using the center as a reference, fix the anti-tip stability device to the wall in exact dimensions according to the dimensions given below.

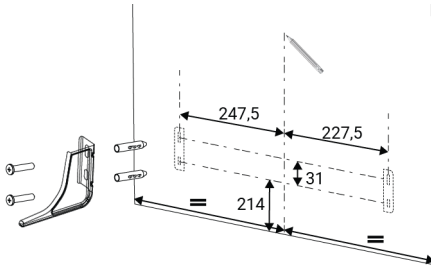

**i** An anti-tip stability device is supplied with the product. You can use this piece on the right or left. The relevant dimensions for both sides are given above. The installation is shown on the left as an example.

3. Place the anti-tip stability device you fixed to the wall into the slot on the back of the product as shown below.

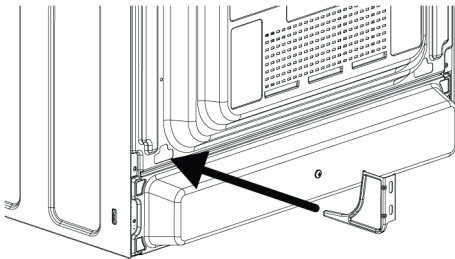

## 4.2 Electrical connection

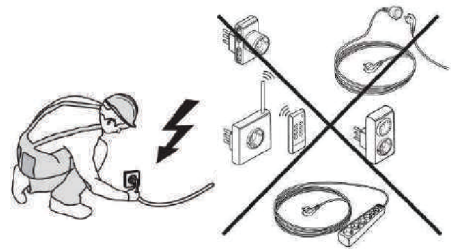
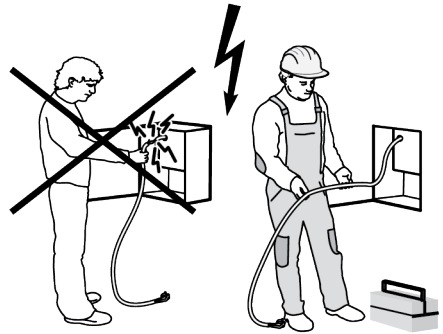

- Disconnect the product from the electric connection before starting any work on the electrical installation. There is an electric shock hazard.
- Connect the product to a grounded outlet/line protected by a miniature circuit breaker of suitable capacity as stated in the "Technical specifications" table. Have the grounding installation made by a qualified electrician while using the product with or without a transformer. Our company shall not be liable for any damages that will arise due to using the product without a grounding installation in accordance with the local regulations.
- The product can only be connected to the mains electricity connection by an authorized and qualified person, and the warranty of the product starts only after correct installation. The manufacturer cannot be held responsible for any damages that may arise due to operations by unauthorized persons.

- The electric cable must not be crushed, folded, jammed or touch hot parts of the product. If the electric cable is damaged, it must be replaced by a qualified electrician. Otherwise there is an electric shock, short circuit or fire hazard!
- The mains supply data must correspond to the data specified on the type label of the product. The rating plate is either seen when the door or the lower cover of the appliance is opened or it is located at the rear wall of the appliance depending on the appliance type.
- and must use the appropriate socket outlet/line and plug for oven. In case of the product's power limits are out of current carrying capability of plug and socket outlet/line, the product must be connected through fixed electrical installation directly without using plug and socket outlet/line.
- **If the product will be connected directly to the supply power:** If it is not possible to disconnect all poles in the supply power, a disconnection unit with at least 3 mm contact clearance (fuses, line safety switches, contactors) must be connected and all the poles of this disconnection unit must be adjacent to (not above) the product in accordance with IEE directives. Failure to obey this instruction may cause operational problems and invalidate the product warranty.
- Additional protection by a residual current circuit breaker is recommended.

**If the product is produced with cable and without plug:**

Connect the cord of product to supply power as identified below:

## 5 First Use

Before you start using your product, it is recommended to do the following stated in the following sections respectively.

Make the terminal block connection of your product according to the connection/phase information on the product type label.

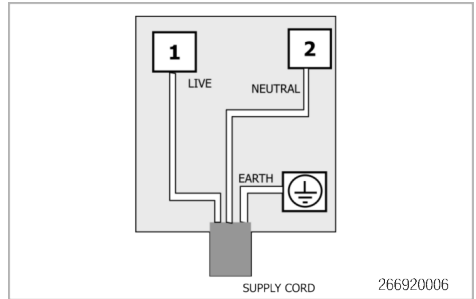

If your supply cord type is 3-conductor type, for 1-phase connection:

- Brown/Black = L (Phase)
- Blue = N (Neutral)
- Green/Yellow wire = (E) ⚡ (Earthing)

### 4.3 Placing the product

1. Push the product towards the kitchen wall.
2. Adjust the feet of oven

#### Adjusting the feet of oven

Vibrations during use may cause cooking vessels to move. This dangerous situation can be avoided if the product is level and balanced.

For your own safety please ensure the product is level by adjusting the four feet at the bottom by turning left or right and align level with the work top.

#### Final check

1. Reconnect the product to the mains.
2. Check electrical functions.

### 5.1 First Timer Setting



Always set the time of day before using your oven. If you do not set it, you cannot cook in some oven models.

1. When the oven is first started, "12:00" and ⌚ symbol will flash on the display.

2. Set the time of day by touching the ⊕/⊖ keys.

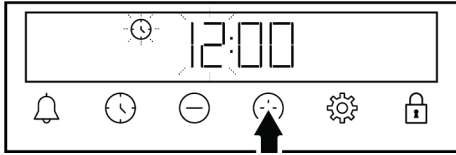

3. Touch ⌚ or ⚙️ key to activate the minutes field.

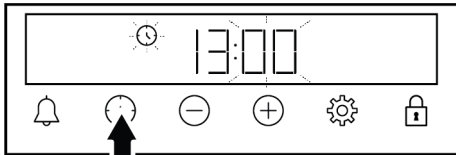

4. Touch the ⊕/⊖ keys to set the minute.

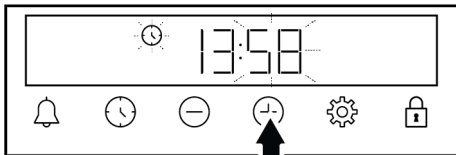

5. Confirm by touching the ⌚ or ⚙️ key.  
⇒ The time of day is set and the ⌚ symbol disappears on the display.

**i** If the first timer is not set, "12:00" and ⌚ symbol continue to flash and your oven will not start. For your oven to function, you must confirm the time of day by setting the time of day or touching the ⌚ key when it is at "12:00". You can change the time of day setting later as described in the "Settings" section.

## 6 How to use the hob

### 6.1 General information on hob usage

- Refrain from using unbalanced and easily tilting pots/pans on the hob.
- Refrain from heating the pots/pans and pots empty. The pots and the appliance may be damaged.
- Always turn off the hob's burners after each use.

**i** In the event of a power outage, the time of day settings are cancelled. It should be set again.

### 5.2 Initial Cleaning

1. Remove all packaging materials.
2. Remove all accessories from the oven provided with the product.
3. Operate the product for 30 minutes and then, turn it off. This way, residues and layers that may have remained in the oven during production are burned and cleaned.
4. Wait for the oven to cool.
5. Wipe the surfaces of the product with a wet cloth or sponge and dry with a cloth.

#### Before using the accessories:

Clean the accessories you remove from the oven with detergent water and a soft cleaning sponge.

**NOTICE:** During the first use, smoke and odour may come up for several hours. This is normal and you just need good ventilation to remove it. Avoid directly inhaling the smoke and odours that form.

- You shall damage the appliance if you operate the hobs without any pot or pots/pans. Always turn off the hobs after each operation.
- After each use the cooking surface will be hot, so refrain from putting the plastic pots/pans on the cooking surface. Clean such material on the surface immediately.



- Sudden temperature changes on the glass cooking surface may cause damage, be careful not to spill cold liquids during cooking.
- Put a sufficient amount of food in pots and pans. Thus, you can prevent food from pouring forth out of the pots/pans and will not need to clean unnecessarily.
- Refrain from placing the covers of pots and pans on burners/zones.
- Place the pots by centering them on the burners/zones. If you wish to place a pot on a different burner/zone, do not slide it towards the desired burner; rather, lift it first and then put it on the other burner.
- Refrain from selecting high heating levels when using non-sticking cooking pots/pans coated with little amount of oil or used without oil (teflon type).
- Keep magnetic objects such as credit cards or tapes away from the hob while it is operating.
- If there is an oven under your hob and it is being operated, the sensors on the hob may reduce the cooking level or turn off the hob.
- Your hob has an automatic shut-off system. Detailed information about this system is provided in the following sections. However, if you use thin based pots for your cooking, these pots shall heat up very quickly and the bottom of the pan may melt and damage the cooking surface and the appliance before the automatic shut-off system is activated.

### **Operating principle of the induction hob**

Induction hob is like an open circuit. The circuit completes when a cooking pots/pans suitable for induction cooking is placed on it and an electronic system below the glass surface generates a magnetic field. The metal base of the pots/pans is heated by taking energy from this magnetic field. Thus, the heat is not generated on the surface of the hob, but directly on the pots/pans above it. Glass surface is heated with the heat of the cooking pots/pans.

### **Advantages of cooking with induction**

Induction hobs offer some advantages as the heat is transferred directly to the cooking pots/pans.

- Foods that overflow during cooking do not burn rapidly as the glass cooking surface is not heated directly. It is cleaned more easily.
- Cooking shall be faster as the heat is generated directly on the cooking pots/pans. Thus, it saves time and energy with respect to other hob types.
- As the heat is given directly to the cooking pots/pans, there is no heat loss, and it provides a more efficient cooking.
- The fact that the heat transfer stops and the cooking surface is not heated directly when the cooking pots/pans is removed from the cooking surface provides a safer use against possible accidents while cooking.

### **Cooking pots/pans**

You shall use ferromagnetic, quality cooking pots/pans which bear a label or warning that it is compatible for induction cooking only with your induction hob. Generally, the higher the iron content, the better the cooking pots/pans shall perform. The base diameter of the cooking pots/pans shall match the induction zone. Suggested dimensions are listed below.

#### **Suitable pots/pans:**

- Cast iron pots/pans
- Enamelled steel pots/pans
- Steel and stainless steel pots/pans (with label or warning indicating that it is induction compatible)

#### **Unsuitable pots/pans:**

- Aluminium pots/pans
- Copper pots/pans
- Brass pots/pans
- Glass pots/pans
- Pottery
- Ceramic and porcelain

#### **Recommendations:**

- Use flat bottomed cooking pots/pans only. Do not use pots/pans with convex or concave bases.

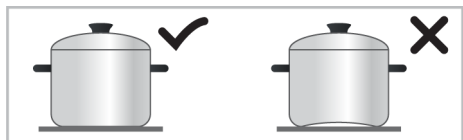

- Use cooking pots/pans with thick, processed bases only. If you use thin based pots, these pots shall heat up very quickly and the bottom of the pan may melt and damage the cooking surface and the appliance before the automatic shut-off system is activated. Sharp edges may cause scratches on the surface.

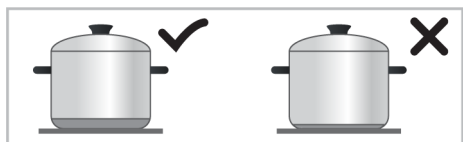

- The bases of some cooking pots/pans have a smaller ferromagnetic field than its true diameter. Only this area is heated by the hob. Therefore, the heat is not evenly distributed and the cooking performance is decreased. Moreover, such cooking pots/pans may not be detected by large induction hobs. Thus, the cooking hob shall be selected according to the size of the ferromagnetic field.

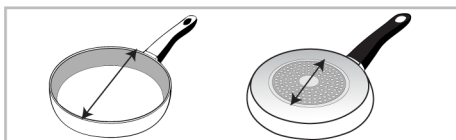

- Some cooking pots/pans have a base that contains non-ferromagnetic materials such as aluminium. These types of cooking pots/pans may not heat adequately or may not be detected by the induction hob at all. In some cases, a bad pots/pans warning may appear.

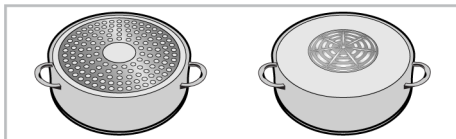

- i** Equal distribution of the cookware on the right and left and center (if available) cooking zones for the selection of cooking zones affects the cooking performance positively while cooking multiple meals on the induction hobs.

### Cooking vessel test

Test whether your pot is compatible with cooking with an induction hob using the methods below.

1. It is compatible if the base of your pot holds a magnet.

### Recommended cooking pots/pans sizes

Cooking zone diameter - mm	Pot diameter - mm
145	min. 100 - max. 145
180	min. 100 - max. 180
210	min. 140 - max. 210
240	min. 140 - max. 240
280	min. 125 - max. 280
320	min. 125 - max. 320
2 x (92,7 x 200)	min. 100 - max. 180
Cooking zone with wide (flexi) surface	width 230 - length 390



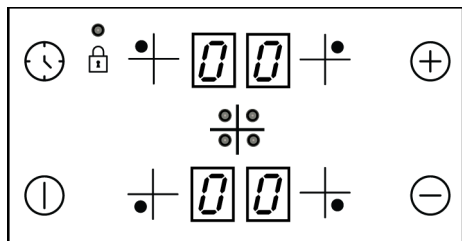

Boiling behavior may vary depending on the pot types, size of the pot and size of the cooking zone. For a more homogenous boiling behavior, a one step larger cooking

zone might be used. To use a larger cooking zone does not cause wasting of energy at induction hobs, because the heat is only created in the relevant pot area.

## 6.2 Hob control unit







### Keys :

-  On/Off key
-  Timer key
-  Increase key
-  Decrease key

### Symbols :

-  Key lock symbol

### Cooking zone selection keys :

-  Rear left cooking zone selection key
-  Front left cooking zone selection key
-  Front right cooking zone selection key
-  Rear right cooking zone selection key

### General information for the control panel

- Graphics and figures are for informational purposes only. Actual displays and functions may vary according to the model of your hob.
- This product is controlled with a touch control panel. Each operation you make on your touch control panel will be confirmed by an audible signal.
- Always keep the control panel clean and dry. Having damp and soiled surface may cause problems in the functions.

### Turning on the hob

1. Touch the  key on the control panel.  
⇒ "0" icon appears on all cooking zone displays.

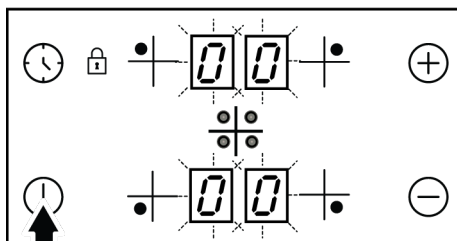

-  If no operation is performed within 20 seconds, the hob will automatically return to Standby mode.

### Turning off the hob

1. Touch the  key on the control panel.  
⇒ The hob will turn off and return to Standby mode.

-  "H" or "h" symbol that appears on the cooking zone display indicates that the cooking zone is still hot. Do not touch cooking zones.

### Residual heat indicator

"H" symbol that appears on the cooking zone display indicates that the hob is still hot and may be used to keep a small amount of food warm. This symbol will soon turn to "h" symbol meaning less hot.

-  When power is cut off, residual heat indicator will not light up and does not warn the user against hot cooking zones.

### Turning on the cooking zones

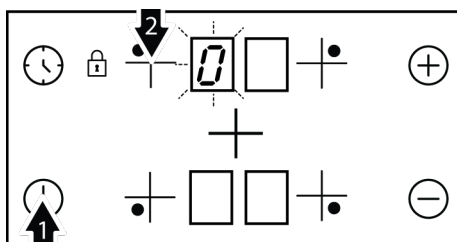

1. Touch  key to turn on the hob.

2. Touch the selection key of the cooking zone you want to turn on.

⇒ “0” symbol appears on the cooking zone display and the related display illuminates more brightly.

 If no operation is performed within 20 seconds, the hob will automatically return to Standby mode.

### Setting the temperature level

Touch  $\oplus$  or  $\ominus$  keys to set the temperature level between “1” and “9” or “9” and “1”.

 The product might start-stop when it is operating on levels from 1 to 7, especially with cookware with a small diameter and when water-oil is little. This is not a fault.

 The outer section of the 280 mm induction hob cooking zone (if your product is equipped with a 280 mm induction hob cooking zone) is activated only when a saucepan large enough to cover the cooking zone is placed on the cooking zone and the temperature is set to a level higher than 8.

### Turning off the cooking zones:

A cooking zone can be turned off in 3 different ways:

1. **By dropping the temperature level to “0”:** You can turn the cooking zone off by dropping the temperature adjustment to “0” level.
2. **By touching the relevant cooking zone symbol for a certain time:** Turn on the cooking zone by pressing relevant symbol for a certain time to drop temperature value to “0”.
3. **By using the turn-off on the timer option for the desired cooking zone:** When the time is over, the timer will turn off the cooking zone assigned to it. “0” or “00” will appear on related display. When the time is over, an audible alarm will sound. Touch any key on the control panel to silence the audible alarm.

### High Power (Booster) It varies depending on the product model. It may not be available on your product.

For rapid heating, you can use booster function “P”. However, this function is not recommended for cooking a long time. Booster function may not be available in all cooking zones.

#### Turning on High Power (Booster):

1. Touch  $\text{⓪}$  key to turn on the hob.
2. Select the desired cooking zone by touching the cooking zone selection keys.
3. Touch  $\oplus$  or  $\ominus$  key firstly to reach the level “9”.

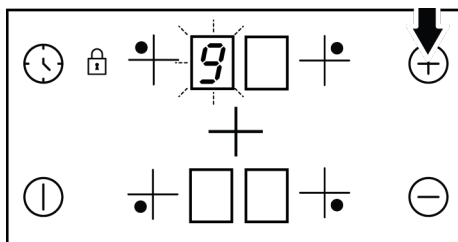

4. When the cooking zone is at level “9”, touch  $\oplus$  key once to set cooking zone temperature to “P”.

#### Turning off High Power (Booster):

- To disable the Booster function, touch  $\ominus$  and set the temperature to level “9”. Cooking zone goes out of booster and continues to operate at level “9”.
- You can decrease the temperature level by touching  $\ominus$  or you can switch off the cooking zone completely by decreasing the temperature level to “0”.

#### Keylock

You can activate the keylock to avoid changing the functions by mistake when the hob is operating.

#### Activating the keylock

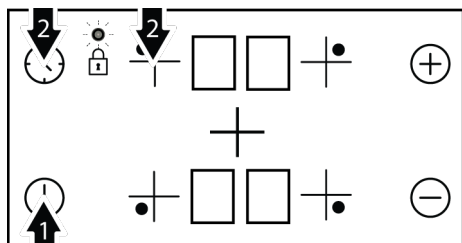

1. Touch  $\text{⓪}$  key to turn on the hob.
2. Touch  $\text{⌚}$  and  $\text{⊕}$  keys simultaneously to activate the keylock.



⇒ Keylock will be activated and the dot on the symbol  will light up.

 If you turn the hob off when the keys are locked, the keylock will be activated next time you turn the hob on again. Key lock must be deactivated in order to be able to operate the hob.

### Deactivating the keylock

1. When the keylock is active, touch  and  keys simultaneously.

⇒ Keylock will be deactivated and the dot on the symbol  will disappear.





### Childlock It varies depending on the product model. It may not be available on your product.

You can protect the hob against being operated unintentionally in order to prevent children from turning on the cooking zone. Child Lock can only be activated and deactivated in Standby mode.

Child Lock can only be activated and deactivated in Standby mode.

 Child lock will be cancelled in case of power failure.



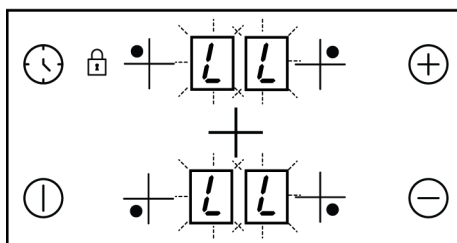

### Activating the childlock

1. Touch  key to turn on the hob.
2. Touch  and  keys simultaneously After “beep” signal touch  to activate the childlock.



⇒ Childlock will be activated and “L” symbol appears on all cooking zone display.

### Deactivating the childlock

1. When the keylock is active, touch  key to turn on the hob.
2. Touch  and  keys simultaneously After “beep” signal touch  to deactivate the childlock.

⇒ Childlock will be deactivated and “L” symbol disappears on all cooking zone display.



### Timer function

This function facilitates cooking for you. It will not be necessary to attend the oven for the whole cooking period. Cooking zone will be turned off automatically at the end of the time you have selected.

### Activating the timer

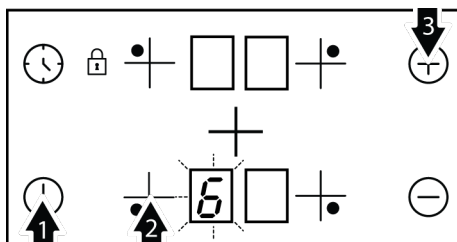
1. Touch  key to turn on the hob.
2. Select the desired cooking zone by touching the cooking zone selection keys.



3. Touch  or  keys to set the desired temperature level.
4. Touch  key to turn the timer on.

- ⇒ “00” symbol will illuminate on timer display and decimal point will appear on the selected cooking zone display.

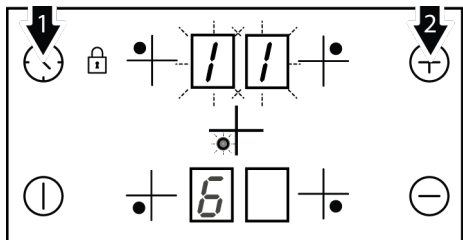

**i** Right rear and left rear cooking zone displays serve as timer display when the timer is active.

5. Touch ⊕ or ⊖ keys to set the desired time.

**i** The timer can only be set for the cooking zones already in use.

**i** Repeat the above procedures for the other cooking zones for which you wish to set the timer.

**i** Timer cannot be adjusted unless the cooking zone and the temperature value for the cooking zone are selected.

**i** When the cooking zone for which a timer was set is selected, you can see the remaining time by touching the ⌚ key again.

### Deactivating the timer

Once the set time is over, the hob will automatically turn off and give an audible warning. Press any key to silence the audio warning.

### Turning off the timers earlier

- ✓ If you turn off the timer earlier, the hob will carry on operating at the set temperature until it is turned off.
1. Select the cooking zone you want to turn off.
  2. Touch ⌚ key to turn the timer on.

3. Until “00” appears on the timer screen, touch ⊖ to set the value to “00”.

- ⇒ Dot shaped light on the relevant cooking zone display itself turns off **completely** after having flashed for a certain period of time and the timer is cancelled.

**Power management function It varies depending on the product model. It may not be available on your product.**

Your product has a power management function. With the help of this function, you can change the total power setting that the hob will draw.

**i** Power management can only be done when the product is first installed and first energized. You can complete the setting by following the steps below within 30 seconds when the product is first energized.

### Power management function - Adjustable total power levels

Power management display indicator Total power

25	2.5 kW
30	3 kW
36	3.6 kW
44	4.4 kW
54	5.4 kW
57	5.7 kW
67	6.7 kW
72	7.2 kW

**i** If the total power of your product is below the desired power, your product will operate at the total power level given in the technical table. (Technical Specifications)

### To change the total power;

1. When the product is first energized, touch the keys ⊕/⊖/⊕/⊖/⊕ within 30 seconds.
2. The power management level set is displayed on the timer display.

3. Touch the ⊕ key to switch between levels and set the total power value you want to set.
4. Confirm the setting by touching the ⓘ key and turn off the hob. Total power value you have set shall be activated

 The temperature levels you may assign to the hobs may vary as per the total power level set. The temperature level provided to the hob be reduced automatically as per the power setting to be performed by the hob. This is not an error.

 If a key other than the specified sequence is touched while changing the power level, the setting cannot be made. You have to repeat the steps from the beginning to make the setting.

### Using induction cooking zones safely and efficiently

**Operating principles:** Induction hob heats directly the cooking vessel as a feature of its operating principles. Therefore, it has various advantages when compared to other hob types. It operates more efficiently

and the hob surface does not heat up. Induction hob is equipped with superior safety systems that will provide you maximum usage safety.

 Your hob can be equipped with induction cooking zones with a diameter of 145, 180, 210-280 mm depending on the model. With induction feature, each cooking zone detects each vessel placed on them. Energy builds up only where the vessel contacts with the cooking zone and thus, minimum energy consumption is achieved.

### Automatic turning off system

The hob control has an automatic turn off system. If one or more hob zone(s) are left on, the hob zone turns off automatically after a while (See Table-1). In case of a timer assigned to the hob, the timer screen is turned off then, too. The time limit for automatic turn off depends on the selected temperature level. Maximum operating period is applied for this temperature level. The hob zone may be operated by the user again after it is turned off automatically as described above.

Temperature level	Automatic turning off periods - hours
0	0
1	6
2	6
3	5
4	5
5	4
6	1,5
7	1,5
8	1,5
9	20-30 minute
P (Booster)	5-10 minute*

(\*) The hob will drop to level 9 after 5 minutes

**Table 1: Table-1: Automatic turning off periods**

### Overheating protection

Your hob is equipped with some sensors ensuring protection against overheating. Following may be observed in case of overheating:

- Active cooking zone may be turned off.

- Selected level may drop. However, this condition cannot be seen on the indicator.



### Overflow safety system

Your hob is equipped with overflow safety system. If there is any overflow that spills onto the control panel, system will cut the power connection immediately and turn off your hob. "F" warning appears on display during this period.

### Precise power setting

Induction hob reacts the commands immediately as a feature of its operating principles. It changes the power settings very

fast. Thus, you can prevent a cooking pot (containing water, milk and etc.) from overflowing even if it was just about to overflow.

-  If the surface of the touch control panel is exposed to intense vapor, entire control system may become deactivated and give error signal.
-  Keep the surface of the touch control panel clean. Erroneous operation may be observed.

## 7 Using the Oven

### 7.1 General Information on Using the Oven

**Cooling fan ( It varies depending on the product model. It may not be available on your product. )**

Your product has a cooling fan. The cooling fan is activated automatically when necessary and cools both the front of the product and the furniture. It is automatically deactivated when the cooling process is finished. Hot air comes out over the oven door. Refrain from covering these ventilation openings. Otherwise, the oven may overheat. The cooling fan continues to operate during oven operation or after the oven is turned off (approximately 20-30 minutes). If you cook by programming the oven timer, at the end of the baking time, the cooling fan turns off with all functions. The cooling fan running time cannot be determined by the user. It turns on and off automatically. This is not an error.

### Oven lighting

The oven lighting is turned on when the oven starts baking. In some models, the lighting is on during baking, while in some models it turns off after a certain time.

### 7.2 Using the bottom section of the oven

#### General warnings for the oven control unit

- The maximum time that can be set for the baking process is 5 hours 59 minutes. In case of a power failure, the program is canceled. You will need to re-program
- While making any adjustments, the relevant symbols flash on the display. A short time should be waited for the settings to be saved.
- If any cooking setting has been made, the time of day cannot be adjusted.
- If cooking time is set when cooking starts, the remaining time is displayed on the display.
- In cases where cooking time or cooking end time is set; you can cancel automatically by touching the ⌚ key for a long time.

#### Timer

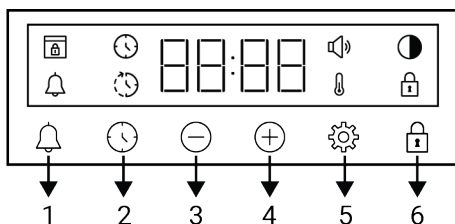









1 Alarm key



- 2 Time setting key
- 3 Decrease key
- 4 Increase key
- 5 Settings key
- 6 Key lock key

#### Display symbols

-  : Baking time symbol
-  : Baking end time symbol \*
-  : Alarm symbol
-  : Brightness symbol
-  : Key lock symbol
-  : Temperature symbol
-  : Volume level symbol
-  : Door lock symbol \*

\*It varies depending on the product model. It may not be available on your product.

### Turning on the oven

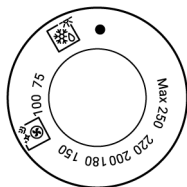



When you set a certain temperature with the oven control knob, the oven starts operating.

### Turning off the oven

You can turn the oven off by turning the oven control knob to the off (up) position.

### Manual cooking to select temperature



You can cook by making a manual control (at your own control) without setting the cooking time by selecting the temperature specific to your food.

1. Set the temperature you want to cook with the oven control knob
  - ⇒ Your oven will start operating immediately at the selected temperature, and the symbol  will appear on the display. When the temperature inside the oven reaches the set temperature, the symbol  disappears. The oven does not switch off automatically since manual cooking is done without setting



the cooking time. You have to control cooking and turn it off yourself. When your cooking is completed, turn off the oven by turning the oven control knob to the off (up) position

### Cooking by setting the cooking time;

You can have the oven turn off automatically at the end of the time by selecting the temperature specific to your food and setting the cooking time on the timer

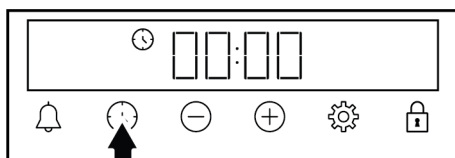
1. Select the temperature for cooking
2. Touch the  key until the  symbol appears on the display for the cooking time.



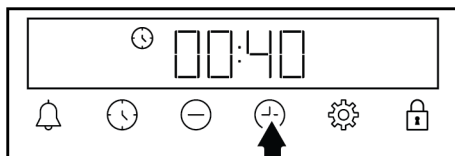

-  After setting the temperature, you can set the cooking time for 30 minutes by touching the  key directly for quick setting of the cooking time and change the time with the  keys.

3. Set the cooking time with the  keys.



-  The cooking time increases by 1 minute in the first 15 minutes, after 15 minutes it increases by 5 minutes.

4. Put your food in the oven.
5. Your oven will start operating immediately at the selected temperature. The set cooking time starts to count down and the  symbol appears on the display. When the temperature inside the oven reaches the set temperature, the symbol disappears.

- After the set cooking time is completed, on the display, "End" appears, the  symbol flashes and the timer beeps.
- The warning sounds for two minutes. Press any key to stop the warning. The warning stops and the time of day appears on the display.

 If any key is pushed at the end of the audible warning, the oven will start operating again. To prevent the oven from operating again at the end of the warning, turn off the oven by turning the oven control knob to the "0" (off) position.



## 7.2.1 Settings

### Activating the key lock

By using the key lock feature, you can safeguard the timer from interference.

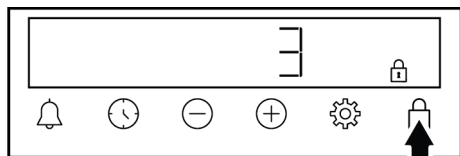
- Touch the key until the  symbol appears on the display.





⇒ The  symbol is shown on the display and the 3-2-1 count down starts. The key lock activates when the countdown ends. When any key is touched after the key lock is set, the timer sounds an audible signal and the  symbol flashes.

 If you release the key before the end of the countdown, the key lock does not activate.

 Timer keys cannot be used when the key lock is on. The key lock will not be cancelled in case of power failure.

### Deactivating the key lock



- Touch the key until the  symbol disappears from the display.

⇒ The  symbol disappears from the display and the key lock is disabled.

### Setting the alarm

You can also use the timer of the product for any warning or reminder other than baking. The alarm clock has no effect on the oven operating functions. It is used for warning purposes. For example, you can use the alarm clock when you want to turn the food in the oven at a certain time. As soon as the time you set has expired, the timer gives you an audible warning.

 The maximum alarm time may be 23 hours 59 minutes.

- Touch the  until the key  symbol appears on the display.

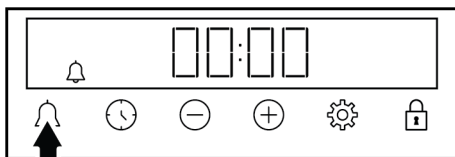

- Set the alarm time with the  $\oplus/\ominus$  keys.

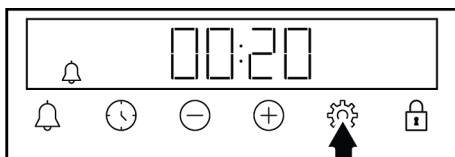

⇒ After setting the alarm time, the  symbol remains lit and the alarm time starts to countdown on the display. If the alarm time and baking time are set at the same time, the shorter time is shown on the display.

- After the alarm time is completed, the  symbol starts flashing and gives you an audible warning.

### Turning off the alarm

- At the end of the alarm period, the warning sounds for two minutes. Touch any key to stop the audible warning.

⇒ The warning stops and the time of day appears on the display.

### If you want to cancel the alarm;

1. Touch the 🔔 key until the 🔔 symbol appears on the display to reset the alarm time. Touch the ⊖ key until the "00:00" symbol appears on the display.
2. You can also cancel the alarm by touching the 🔔 key for a long time.

### Adjusting the volume

1. Touch ⚙️ key until the 🔊 symbol appears on the display.

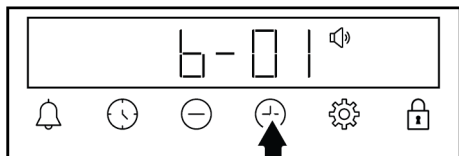

2. Set the desired level with the ⊕/⊖ keys. (b-01-b-02-b-03)

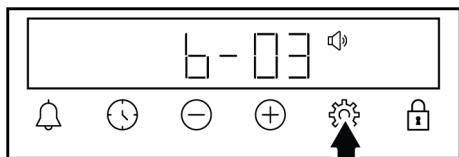

3. Touch the ⚙️ key for confirmation or wait without touching any key. The volume set becomes active after a while.

### Setting the display brightness

1. Touch ⚙️ key until the 🌓 symbol appears on the display.

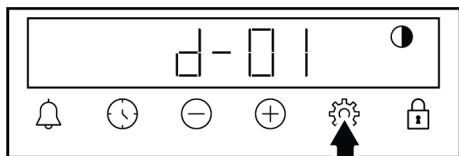

2. Set the desired brightness with the ⊕/⊖ keys. (d-01-d-02-d-03)

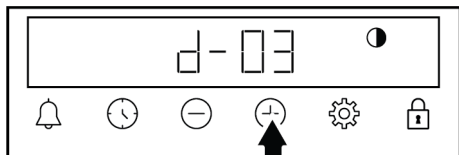

3. Touch the ⚙️ key for confirmation or wait without touching any key. The brightness set becomes active after a while.

### Changing the time of day

On your oven to change the time of day that you have previously set:

1. Touch the ⚙️ key until the 🕒 symbol appears on the display.
2. Set the time of day by touching the ⊕/⊖ keys.

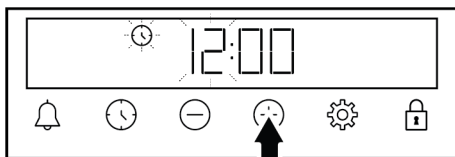

3. Touch 🕒 or ⚙️ key to activate the minutes field.

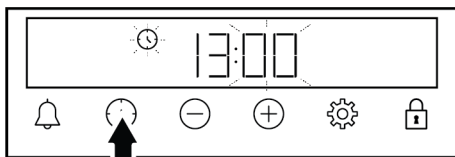

4. Touch the ⊕/⊖ keys to set the minute.

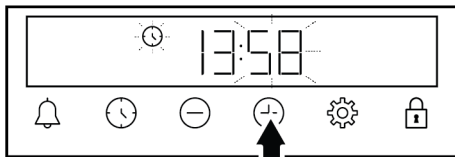

5. Confirm by touching the 🕒 or ⚙️ key.  
⇒ The time of day is set and the 🕒 symbol disappears on the display.

## 7.3 Using the upper section of the oven



Grill oven can be used both as a grill and a baking oven. Switch on the top oven operates the oven when the oven door is closed, and the grill when the oven door is opened.

Grill oven can be used both as a grill and a baking oven. Switch on the top oven operates the oven when the oven door is closed, and the grill when the oven door is opened.

### Turning on the oven

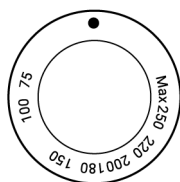

- ✓ Oven is operated with Function knob. Oven is turned off when the Function knob is in Off (upper) position.

1. Close the oven door.
2. Set the oven temperature.
  - ⇒ Temperature light will turn of when the set temperature is attained.

### Turning off the grill oven

Turn the Function knob to Off (top) position.

### Switching on the grill

Grill is operated with function knob. Grill is turned off when the Function knob is in Off (upper) position.

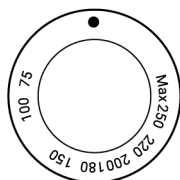

1. Open the oven / grill door.
2. Set the grill temperature to 150 °C and if required, perform a preheating for about 5 minutes.
3. Then, select the desired grilling temperature.
  - ⇒ Thermostat (temperature) light turns on.

### Turning off the grill oven

1. Turn the Function knob to Off (top) position.



While cooking is in progress, when the electricity is cut and comes back again, the top oven continues to operate. In case of any power failure, make sure to turn off the oven.

## 7.4 Steam Assisted Cooking

Your oven has a steam assisted cooking feature. Better baking results are achieved with steam assist. Steam assist ensures that the surface of pastry foods are brighter, their crust is more crunchy and they are more voluminous. Also, steam assist reduces the moisture loss of the foods such as meat and allows them to be cooked more juicy on the inside and more delicious.

### General information

- Steam assisted cooking can only be performed with the steam assisted cooking functions specified in the manual.
- Condensation formed on the oven door after steam assisted cooking may drip around when the oven door is opened. As soon as you open the oven door, wipe off the condensation.
- Stay away when opening the oven door, as steam and heat may escape during and after steam assisted cooking. The steam may burn your hand, face and/or eyes.
- If water remains inside the oven after each steam assisted cooking, dry the remaining water with a dry cloth after the oven has cooled-down. Otherwise, residual water may lead to calcification.
- If your product has a meat probe, make sure that the meat probe cover is closed before steam assisted cooking. Otherwise, there may be steam leakage from the meat probe socket.

### For steam assisted cooking:

1. After checking the steam-assisted baking table and determine temperature, time and amount of water to be added according to the food you want to cook. You can set these values yourself for baking not included in the table.
2. Pour the amount of water you will use according to your food into the pool at the bottom of the oven.

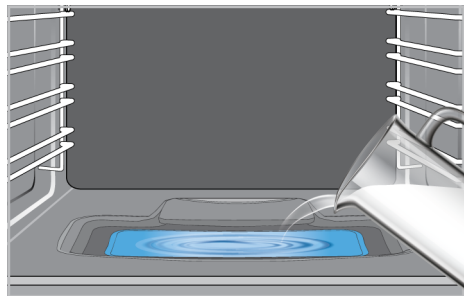

**i** Refrain from using distilled or filtered water. Use ready-made waters only.

3. Push the steam assisted cooking/cleaning button on the control panel.

⇒ The steam assisted cooking/cleaning lamp on the control panel will illuminate.

4. Switch the oven control knob to the desired temperature.
  - ⇒ Your oven will start operating immediately at the selected function and temperature and **i** will appear on the display. When the temperature inside the oven reaches the set temperature the **i** symbol disappears.
5. Place your food in the oven at the recommended rack position.
  - ⇒ Baking starts.
6. Once the baking is completed, turn off the oven by setting the oven control knob to off position.

**i** If water remains on the bottom of the oven after each steam assisted cooking, dry the remaining water with a dry cloth after the oven has cooled. Otherwise, water remaining on the oven floor may cause calcification.

## 8 General Information About Cooking

You can find tips on preparing and cooking your food in this section.

Plus, this section describes some of the foods tested as producers and the most appropriate settings for these foods. Appropriate oven settings and accessories for these foods are also indicated.

### 8.1 General information about cooking with hob

- Never fill the pan with oil more than one third of it. Do not leave the hob unattended when heating oil. Overheated oils bring risk of fire. Never attempt to extinguish a possible fire with water! When oil catches fire, cover it with a fire blanket or damp cloth. Turn off the hob if it is safe to do so and call the fire department.

- Before frying foods, always remove their excess water and put them inside the heated oil slowly. Make sure that frozen foods are defrosted before frying.
- When heating oil, make sure that the pot you use is dry and keep its lid open.
- For recommendations on cooking with power saving, refer to the "Environmental Instructions" section.

### 8.2 General Warnings About Baking in the Oven

- While opening the oven door during or after baking, hot-burning steam may emerge. The steam may burn your hand, face and/or eyes. When opening the oven door, stay away.
- Intense steam generated during baking may form condensed water drops on the interior and exterior of the oven and on

the upper parts of the furniture due to the temperature difference. This is a normal and physical occurrence.

- The cooking temperature and time values given for foods may vary depending on the recipe and amount. For this reason, these values are given as ranges.
- Always remove unused accessories from the oven before you start cooking. Accessories that will remain in the oven may prevent your food from being cooked at the correct values.
- For foods that you will cook according to your own recipe, you can reference similar foods given in the cooking tables.
- Using the supplied accessories ensures you get the best cooking performance. Always observe the warnings and information provided by the manufacturer for the external cookware you will use.
- Cut the greaseproof paper you will use in your cooking in suitable sizes to the container you will cook. Greaseproof papers that are overflowing from the container can create a risk of burns and affect the quality of your baking. Use the greaseproof paper you will use in the temperature range specified.
- For good baking performance, place your food on the recommended correct shelf. Do not change the shelf position during baking.



Be careful not to touch the hot oven door glass with your hand when placing the food into the oven after preheating and when removing the food from the oven after cooking.

Be sure to use accessories such as gloves that provide heat insulation.

## 8.2.1 Pastries and oven food

### General Information

- We recommend using the accessories of the product for a good cooking performance. If you will use an external cookware, prefer dark, non-sticking and heat resistant ware.

- If preheating is recommended in the cooking table, be sure to put your food in the oven after preheating.
- If you will cook by using cookware on the wire grill, place it in the middle of the wire grill, not near the back wall.
- All materials used in making pastry should be fresh and at room temperature.
- The cooking status of the foods may vary depending on the amount of food and the size of the cookware.
- Metal, ceramic and glass moulds extend the cooking time and the bottom surfaces of pastry foods do not brown evenly.
- If you are using baking paper, a small browning can be observed on the bottom surface of the food. In this situation, you may have to extend your cooking period by approximately 10 minutes.
- The values specified in the cooking tables are determined as a result of the tests carried out in our laboratories. Values suitable for you may differ from these values.
- Place your food on the appropriate shelf recommended in the cooking table. Refer to the bottom shelf of the oven as shelf 1.
- Cook the recommended dishes in the cooking table with a single tray.

### Tips for baking cakes

- If the cake is too dry, increase the temperature by 10°C and shorten the baking time.
- If the cake is moist, use a small amount of liquid or reduce the temperature by 10°C.
- If the top of the cake is burnt, put it on the lower shelf, lower the temperature and increase the baking time.
- If the inside of the cake is cooked well, but outside is sticky, use less liquid, decrease the temperature and increase the cooking time.

## Hints for pastry

- If the pastry is too dry, increase the temperature by 10 °C and shorten the cooking time. Wet the dough sheets with a sauce consisting of milk, oil, egg and yoghurt mixture.
- If the pastry is getting cooked slowly, make sure that the thickness of the pastry you have prepared does not overflow the tray.
- If the pastry is browned on the surface but the bottom is not cooked, make sure that the amount of sauce you will use for

the pastry is not too much at the bottom of the pastry. For an even browning, try to spread the sauce evenly between the dough sheets and the pastry.

- Bake your pastry in the position and temperature appropriate to the cooking table. If the bottom is still not browned enough, place it on a bottom shelf for the next cooking.

## Cooking table for the upper cooking section

Food	Accessory to be used	Shelf position	Temperature (°C)	Baking time (min) (approx.)
Cookie	Standard tray *	1	170	25 ... 35
Dough pastry	Standard tray *	1	180	35 ... 45
Lasagne	Glass / metal rectangular container on wire grill **	1	200	30 ... 45
Pizza	Standard tray *	1	220	10 ... 20
Small cakes	Standard tray *	1	160	25 ... 35
Rich pastry	Standard tray *	1	180	25 ... 35
Sponge cake	Round springform pan, 26 cm in diameter on wire grill	1	150	45 ... 55

Preheating is recommended for all food.

\*These accessories may not be included with your product.

\*\*These accessories are not included with your product. They are commercially available accessories.

## Cooking table for the bottom cooking section

### Suggestions for baking with a single tray

Food	Accessory to be used	Shelf position	Temperature (°C)	Baking time (min) (approx.)
Cake on the tray	Standard tray *	2	180	30 ... 40
Cake in the mould	Cake mould on wire grill** **	2	180	30 ... 40
Shortbread (sweet cookie)	Standard tray *	On models with wire shelves :3 On models without wire shelves :2	140	20 .. 30
Small cakes	Standard tray *	2	150	25 ... 35
Sponge cake	Round springform pan, 26 cm in diameter on wire grill **	2	160	25 ... 35
Cookie	Standard tray *	3	170	20 ... 30
Rich pastry	Standard tray *	2	180	35 ... 45
Dough pastry	Standard tray *	3	180	20 ... 30
Whole bread	Standard tray *	3	200	30 ... 40

Food	Accessory to be used	Shelf position	Temperature (°C)	Baking time (min) (approx.)
Lasagne	Standard tray *	2 or 3	200	30 ... 40
Apple pie	Round black metal mould, 20 cm in diameter on wire grill **	2	180	50 ... 70
Pizza	Standard tray *	3	200 ... 220	10 ... 20

### Suggestions for cooking with two trays

Food	Accessory to be used	Shelf position	Temperature (°C)	Baking time (min) (approx.)
Small cakes	2-Standard tray * 4-Pastry tray *	2 - 4	150	25 ... 40
Cookie	2-Standard tray * 4-Pastry tray *	2 - 4	170	25 ... 35
Rich pastry	1-Standard tray * 4-Pastry tray *	1 - 4	180	35 ... 45
Dough pastry	2-Standard tray * 4-Pastry tray *	2 - 4	180	20 ... 30

Preheating is recommended for all food.

\*These accessories may not be included with your product.

\*\*These accessories are not included with your product. They are commercially available accessories.

## 8.2.2 Meat, Fish and Poultry

### The key points on roasting

- Seasoning it with lemon juice and pepper before cooking whole chicken, turkey and large pieces of meat will increase cooking performance.
- It takes 15 to 30 minutes more to cook boned meat than fillet by frying.
- You should calculate about 4 to 5 minutes of cooking time per centimetre of the meat thickness.

- After the cooking time is expired, keep the meat in the oven for approximately 10 minutes. The juice of the meat is better distributed to the fried meat and does not come out when the meat is cut.
- Fish should be placed on the medium or low level shelf in a heat resistant plate.
- Cook the recommended dishes in the cooking table with a single tray.

### Cooking table for the upper cooking section

Food	Accessory to be used	Shelf position	Temperature (°C)	Baking time (min) (approx.)
Steak (whole) / Roast (1 kg)	Standard tray *	1	15 mins. 250/max, after 180 ... 190	60 ... 80
Lamb's shank (1,5-2 kg)	Standard tray *	1	15 mins. 250/max, after 170	110 ... 120
Fish	Wire grill * Place one tray on a lower shelf	1	200	20 ... 40

Preheating is recommended for all food.

\*These accessories may not be included with your product.

\*\*These accessories are not included with your product. They are commercially available accessories.



## Cooking table for the bottom cooking section

Food	Accessory to be used	Shelf position	Temperature (°C)	Baking time (min) (approx.)
Steak (whole) / Roast (1 kg)	Standard tray *	3	15 mins. 250/max, after 180 ... 190	60 ... 80
Lamb's shank (1,5-2 kg)	Standard tray *	3	15 mins. 250/max, after 170	110 ... 120
Fried chicken (1,8-2 kg)	Wire grill * Place one tray on a lower shelf	2	220	60 ... 80
Turkey (5,5 kg)	Standard tray *	1	25 mins. 250/max, after 180 ... 190	150 ... 210
Fish	Wire grill * Place one tray on a lower shelf	3	200	20 ... 30

Preheating is recommended for all food.

\*These accessories may not be included with your product.

\*\*These accessories are not included with your product. They are commercially available accessories.

### 8.2.3 Grill

Red meat, fish and poultry meat quickly turns brown when grilled, holds a beautiful crust and does not dry out. Fillet meats, skewer meats, sausages as well as juicy vegetables (tomatoes, onions, etc.) are particularly suitable for grilling.

#### General warnings

- Food not suitable for grilling carries a fire hazard. Grill only food that is suitable for heavy grill fire. Also, do not place the food too far in the back of the grill. This is the hottest area and fatty foods may catch fire.
- **Keep the oven door open during grilling. Since the door will be open during grilling, hot surfaces may cause burns! Keep children away from the product.**

#### The key points of the grill

- Prepare foods of similar thickness and weight as much as possible for the grill.
- Place the pieces to be grilled on the wire grill or wire grill tray by distributing them without exceeding the dimensions of the heater.
- Depending on the thickness of the pieces to be grilled, the cooking times given in the table may vary.
- Slide the wire grill or the wire grill tray to the desired level in the oven. If you are cooking on the wire grill, slide the oven tray to the lower shelf to collect the oils. The oven tray you will slide should be sized to cover the entire grill area. This tray may not be supplied with the product. Put some water into the oven tray for easy cleaning.

#### Cooking table for the upper cooking section

Food	Accessory to be used	Shelf position	Temperature (°C)	Baking time (min) (approx.)
Fish	Wire grill *	2	250	20 ... 25
Chicken pieces	Wire grill *	2	250	25 ... 35
Meatball (veal) - 12 amount	Wire grill *	2	220	20 ... 30
Lamb chop	Wire grill *	2	250	20 ... 25

Food	Accessory to be used	Shelf position	Temperature (°C)	Baking time (min) (approx.)
Steak - (meat cubes)	Wire grill *	2	250	25 ... 30
Veal chop	Wire grill *	2	250	25 ... 30
Vegetable gratin	Wire grill *	2	220	20 ... 30
Toast bread	Wire grill *	1	250	3 ... 5
Toast bread	Wire grill in tray on wire grill *	1	250	1 ... 3

It is recommended to preheat for 5 minutes for all grilled food.

Turn pieces of food after 1/2 of the total grilling time.

\* These accessories may not be included with your product.

## 8.2.4 Steam assisted cooking

### General Information

- Steam assisted cooking can only be performed with the steam assisted cooking functions specified in the manual. See “Oven operating functions” [► 16] section for steam assisted cooking functions.
- If preheating is recommended in the cooking table, be sure to put your food in the oven after preheating. The durations specified at the time of water supply indicate the time elapsed after preheating.
- The cooking table contains cooking recommendations tested by the manufacturer. You can set the amount of water, temperature, steam assisted cooking function and time for food which are not in the table.
- Do the steam assisted cooking with one tray.

### Suggestions for baking with a single tray - Bottom cooking section

Food	Accessory to be used	Shelf position	Temperature (°C)	Amount of water to be used (ml)	Water intake time	Baking time (min) (approx.)	Approx. food weight (g)
Whole bread **	Standard tray *	2	200	250	before pre-heating	30 ... 35	820
Whole chicken with vegetables ***	Standard tray *	2	25 mins. 250/max, after 190	250	before pre-heating	60 ... 70	2000
Rib steak	Standard tray *	3	180	250	before pre-heating	65 ... 75	1000
Lamb shanks with vegetables	Standard tray *	3	170	350	before pre-heating	90 ... 110	2000
Yeasted bun	Standard tray *	3	180	250	before pre-heating	25 ... 35	1200
Cheesecake	Standard tray *	3	120	200	before pre-heating	45 ... 55	1450

\* These accessories may not be included with your product.

\*\* Do not preheat

\*\*\* Preheat for 10 minutes.

## 8.2.5 Test foods

## Cooking table for the upper cooking section

- Foods in this cooking table are prepared according to the EN 60350-1 standard to facilitate testing of the product for control institutes.

### Grill

Food	Accessory to be used	Shelf position	Temperature (°C)	Baking time (min) (approx.)
Meatball (veal) - 12 amount	Wire grill in tray on wire grill *	2	220	20 ... 30
Toast bread	Wire grill *	1	250	3 ... 5
Toast bread	Wire grill in tray on wire grill *	1	250	1 ... 3

It is recommended to preheat for 5 minutes for all grilled food.

Turn pieces of food after 1/2 of the total grilling time.

\* These accessories may not be included with your product.

## Cooking table for the bottom cooking section

### Suggestions for baking with a single tray

Food	Accessory to be used	Shelf position	Temperature (°C)	Baking time (min) (approx.)
Shortbread (sweet cookie)	Standard tray *	On models with wire shelves :3 On models without wire shelves :2	140	20 ... 30
Small cakes	Standard tray *	2	150	25 ... 35
Sponge cake	Round springform pan, 26 cm in diameter on wire grill **	2	160	25 ... 35
Apple pie	Round black metal mould, 20 cm in diameter on wire grill **	2	180	50 ... 70

### Suggestions for cooking with two trays

Food	Accessory to be used	Shelf position	Temperature (°C)	Baking time (min) (approx.)
Small cakes	2-Standard tray * 4-Pastry tray *	2 - 4	150	25 ... 40

Preheating is recommended for all food.

\*These accessories may not be included with your product.

\*\*These accessories are not included with your product. They are commercially available accessories.

## 9 Maintenance and Cleaning

### 9.1 General Cleaning Information

#### General warnings

- Wait for the product to cool before cleaning the product. Hot surfaces may cause burns!
- Do not apply the detergents directly on the hot surfaces. This may cause permanent stains.
- The product should be thoroughly cleaned and dried after each operation. Thus, food residues shall be easily cleaned and these residues shall be prevented from burning when the product is used again later. Thus, the service life of the appliance extends and frequently faced problems are decreased.
- Do not use steam cleaning products for cleaning.
- Some detergents or cleaning agents cause damage to the surface. Unsuitable cleaning agents are: bleach, cleaning products containing ammonia, acid or chloride, steam cleaning products, descaling agents, stain and rust removers, abrasive cleaning products (cream cleaners, scouring powder, scouring cream, abrasive and scratching scrubber, wire, sponges, cleaning cloths containing dirt and detergent residues).
- No special cleaning material is needed in the cleaning made after each use. Clean the appliance using dishwashing detergent, warm water and a soft cloth or sponge and dry it with a dry cloth.
- Be sure to completely wipe off any remaining liquid after cleaning and immediately clean any food splashing around during cooking.
- Do not wash any component of your appliance in a dishwasher unless otherwise stated in the user's manual.

#### For the hobs:

- Acidic dirt such as milk, tomato paste and oil may cause permanent stains on the hobs and components of the hob

zones, clean any overflowed fluids immediately after cooling down the hob by turning it off.

#### Inox - stainless surfaces

- Do not use acid or chlorine-containing cleaning agents to clean stainless-inox surfaces and handles.
- Stainless-inox surface may change colour in time. This is normal. After each operation, clean with a detergent suitable for the stainless or inox surface.
- Clean with a soft soapy cloth and liquid (non-scratching) detergent suitable for inox surfaces, taking care to wipe in one direction.
- Remove lime, oil, starch, milk and protein stains on the glass and inox surfaces immediately without waiting. Stains may rust under long periods of time.
- Cleaners sprayed/applied to the surface should be cleaned immediately. Abrasive cleaners left on the surface cause the surface to turn white.

#### Enamelled surfaces

- The oven must cool down before cleaning the cooking area. Cleaning on hot surfaces shall create both fire hazard and damage the enamel surface.
- After each use, clean the enamel surfaces using dishwashing detergent, warm water and a soft cloth or sponge and dry them with a dry cloth.
- If your product has an easy steam cleaning function, you can make easy steam cleaning for light non-permanent dirt. (See "Easy Steam Cleaning [▶ 46]").

#### Catalytic surfaces

- The side walls in the cooking area can only be covered with enamel or catalytic walls. It varies by model.
- The catalytic walls have a light matte and porous surface. The catalytic walls of the oven should not be cleaned.

- Catalytic surfaces absorb oil thanks to its porous structure and start to shine when the surface is saturated with oil, in this case it is recommended to replace the parts.

### **Glass surfaces**

- When cleaning glass surfaces, do not use hard metal scrapers and abrasive cleaning materials. They can damage the glass surface.
- Clean the appliance using dishwashing detergent, warm water and a microfiber cloth specific for glass surfaces and dry it with a dry microfiber cloth.
- If there is residual detergent after cleaning, wipe it with cold water and dry with a clean and dry microfiber cloth. Residual detergent may damage the glass surface next time.
- Under no circumstances should the dried-up residue on the glass surface be cleaned off with serrated knives, wire wool or similar scratching tools.
- You can remove the calcium stains (yellow stains) on the glass surface with the commercially available descaling agent, with a descaling agent such as vinegar or lemon juice.
- If the surface is heavily soiled, apply the cleaning agent on the stain with a sponge and wait a long time for it to work properly. Then clean the glass surface with a wet cloth.
- Discolorations and stains on the glass surface are normal and not defects.

### **Plastic parts and painted surfaces**

- Clean plastic parts and painted surfaces using dishwashing detergent, warm water and a soft cloth or sponge and dry them with a dry cloth.
- Do not use hard metal scrapers and abrasive cleaners. They may damage the surfaces.
- Ensure that the joints of the components of the product are not left damp and with detergent. Otherwise, corrosion may occur on these joints.

## **9.2 Cleaning Accessories**

Do not put the product accessories in a dishwasher unless otherwise stated in the user's manual.

## **9.3 Cleaning the hob**

### **Glass cooking surface**

Follow the cleaning steps described for the glass surfaces in the "General cleaning information" section for the cleaning of glass cooking surface. You may complete your cleaning as per the information below for special cases.

- Sugar-based foods such as dark cream, starch and syrup should be cleaned immediately, without waiting for the surface to cool. Otherwise, the glass cooking surface may be permanently damaged.

## **9.4 Cleaning the Control Panel**

- When cleaning the panels with knob-control, wipe the panel and knobs with a damp soft cloth and dry with a dry cloth. Do not remove the knobs and gaskets underneath to clean the panel. The control panel and knobs may be damaged.
- While cleaning the inox panels with knob control, do not use inox cleaning agents around the knob. The indicators around the knob can be erased.
- Clean the touch control panels with a damp soft cloth and dry with a dry cloth. If your product has a key lock feature, set the key lock before performing control panel cleaning. Otherwise, incorrect detection may occur on the keys.

## **9.5 Cleaning the inside of the oven (cooking area)**

Follow the cleaning steps described in the "General Cleaning Information" section according to the surface types in your oven.

### **Cleaning the side walls of the oven**

The side walls in the cooking area can only be covered with enamel or catalytic walls. It varies by model. If there is a catalytic wall, refer to the "Catalytic surfaces" section for information.

If your product is a wire shelf model, remove the wire shelves before cleaning the side walls. Then complete the cleaning as described in the "General Cleaning Information" section according to the side wall surface type.

**To remove the side wire shelves:**

1. Remove the front of the wire shelf by pulling it on the side wall in the opposite direction.
2. Pull the wire shelf towards you to remove it completely.

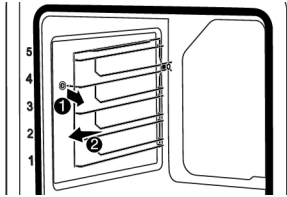

3. To reattach the shelves, the procedures applied when removing them must be repeated from the end to the beginning, respectively.

**Cleaning the water pool on the base of the oven**

Depending on the frequency of steam assisted cooking-easy steam cleaning operations and the hardness of the water used, lime stains may occur in the water pool on the base of the oven.

**To remove the lime that may occur in the water pool on the oven base after steam assisted cooking-easy steam cleaning operations, after every 2 or 3 operations:**

1. Add 350 cc of white vinegar (acidity of the vinegar shall not exceed 6%) to the water pool on the base of the oven.



2. Wait at least 30 minutes to allow the vinegar to dissolve the lime residues at ambient temperature.
3. Clean the water pool with a soft wet cloth with a dry cloth.

**In order to increase the efficiency of descaling likely in the water pool, in addition to the descaling steps above, after every 10 uses:**

Select an operating function in which the lower heater is active and operate the oven at 100 °C for 2-3 minutes. Then, turn off the oven and spray the inside of the oven and grill cleaner recommended on the website for the brand of your product into the water pool on the floor of the oven and leave for 5 minutes. After 5 minutes, wipe the pool of water on the floor of the oven with a damp microfiber cloth and dry it.

**9.6 Easy Steam Cleaning**

This allows cleaning of the dirt (not remaining for a long time) that is softened by the steam inside the oven and by the water droplets condensed in the internal surfaces of the oven easily.

1. Remove all accessories inside the oven.
2. Fill the pool at the floor of the oven with 200 ml of water.

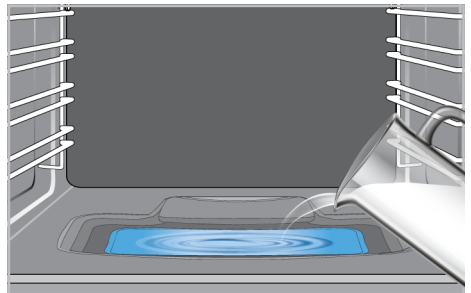

**i** Refrain from using distilled or filtered water. Use ready-made waters only.

3. Push the steam assisted cooking/cleaning button on the control panel.

⇒ The steam assisted cooking/cleaning lamp on the control panel will illuminate.

4. Set the oven to the easy steam cleaning operating mode and operate it at 100°C for 20 minutes.

Open the door and wipe the oven interiors with a wet sponge or cloth.

For stubborn dirt, clean the product using dishwashing detergent, warm water and a soft cloth or sponge and dry it with a dry cloth.

**i** In the easy steam cleaning function, it is expected that the added water evaporates and condenses on the inside of the oven and the oven door in order to soften the light dirt formed in your oven. Condensation formed on the oven door may drip around when the oven door is opened. As soon as you open the oven door, wipe off the condensation.

(It varies depending on the product model. It may not be available on your product.) After the condensation inside the oven, puddle or moisture may occur in the pool channel under the oven. Wipe this pool channel with a damp cloth after use and dry it.

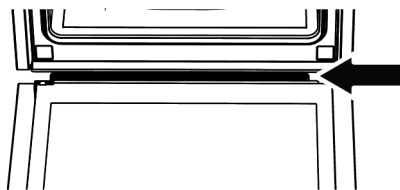

## 9.7 Cleaning The Drop Down Oven Door(s)

You can remove your upper oven door and door glasses to clean them. How to remove the doors and windows is explained in the sections "**Removing the drop down oven door(s)**" and "**Removing the inner glasses of the upper door**". After removing the door inner glasses, clean them using a dishwashing detergent, warm water and a soft

cloth or sponge and dry them with a dry cloth. For lime residue that may form on the oven glass, wipe the glass with vinegar and rinse.

**i** Do not use harsh abrasive cleaners, metal scrapers, wire wool or bleach materials to clean the oven door and glass.

### Removing the drop down oven door(s)

1. Open the oven door.
2. Open the clips in the front door hinge socket on the right and left by pushing them downwards as shown in the figure.
3. Hinge types vary as (A), (B), (C) types according to the product model. The following figures show how to open each type of hinge.
4. (A) type hinge is available in normal door types.

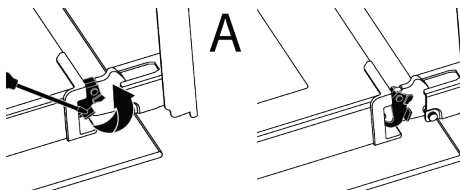

5. (B) type hinge is available in soft closing door types.

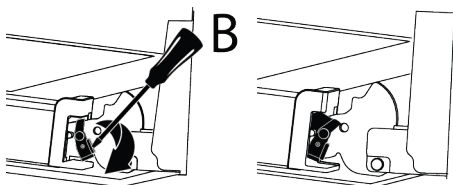

6. (C) type hinge is available in soft opening/closing door types.

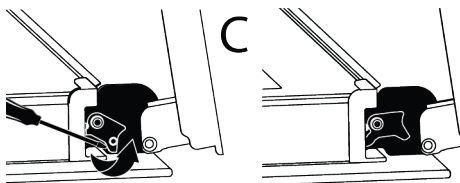

7. Get the oven door to a half-open position.

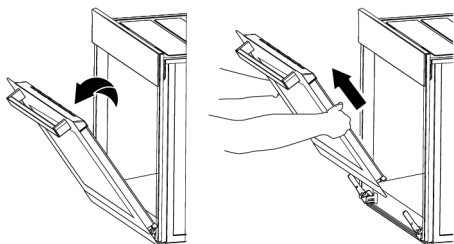

- Pull the removed door upwards to release it from the right and left hinges and remove it.

**i** To reattach the door, the procedures applied when removing it must be repeated from the end to the beginning, respectively. When installing the door, be sure to close the clips on the hinge socket.

## 9.8 Removing the Inner Glass of The Upper Oven Door

Inner glass of the product's front upper oven door may be removed for cleaning.

- Open the oven door.

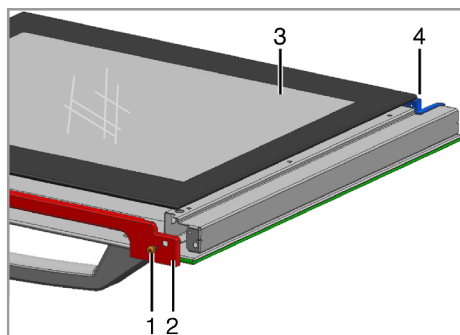

- Screw
- Profile
- Inner glass pane
- Plastic slot

- Take out the screw(1) with a screw-driver.
- Take out the profile (2) than hold up to inner glass (3).

- If your product is equipped with an inner glass panel; Pull the glass holder connecting elements in the middle as illustrated in the figure to free them from the glass panels.

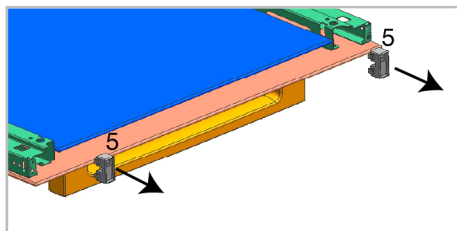

- Glass holder connecting element\*

\* It varies depending on the product model. It may not be available on your product.

- Then group the door again, put the glass pane (3) to the plastic slots (4) and group the profile.

## 9.9 Cleaning the Oven Lamp

In the event that the glass door of the oven lamp in the cooking area becomes dirty; clean using dishwashing detergent, warm water and a soft cloth or sponge and dry with a dry cloth. In case of oven lamp failure, you can replace the oven lamp by following the sections that follow.

### Replacing the oven lamp

#### General information

- To avoid the risk of electric shock before replacing the oven lamp, disconnect the product and wait for the oven to cool. Hot surfaces may cause burns!
- This oven is powered by an incandescent lamp with less than 40 W, less than 60 mm in height, less than 30 mm in diameter, or a halogen lamp with G9 sockets with less than 60 W power. Lamps are suitable for operation at temperatures above 300 °C. Oven lamps are available from Authorised Services or licensed technicians. This product contains a G energy class lamp.
- The position of the lamp may differ from that is shown in the figure.



- The lamp used in this product is not suitable for use in the lighting of home rooms. The purpose of this lamp is to help the user see food products.
- The lamps used in this product must withstand extreme physical conditions such as temperatures above 50 °C.

**If your oven has a round lamp,**

1. Disconnect the product from the electricity.
2. Remove the glass cover by turning it counter clockwise.



3. If your oven lamp is type (A) shown in the figure below, rotate the oven lamp as shown in the figure and replace it with a new one. If it is type (B) model, pull it out as shown in the figure and replace it with a new one.

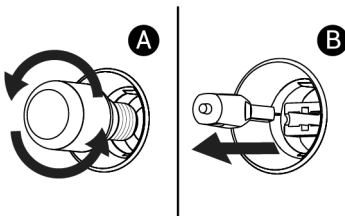

4. Refit the glass cover.

**If your oven has a square lamp,**

1. Disconnect the product from the electricity.
2. Remove the wire shelves according to the description.

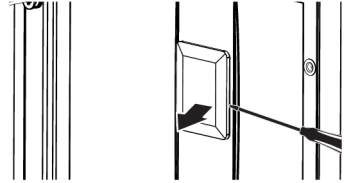

3. Lift the lamp's protective glass cover with a screwdriver. Remove the screw first, if there is a screw on the square lamp in your product.
4. If your oven lamp is type (A) shown in the figure below, rotate the oven lamp as shown in the figure and replace it with a new one. If it is type (B) model, pull it out as shown in the figure and replace it with a new one.

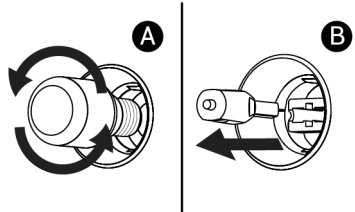

5. Refit the glass cover and wire shelves.

## 10 Troubleshooting

If the problem persists after following the instructions in this section, contact your vendor or an Authorized Service. Never try to repair your product yourself.

**Steam is emanated while the oven is working.**

- It is normal to see vapour during operation. >>> This is not an error.

**Water droplets appear while cooking**

- The steam generated during cooking condenses when it comes into contact with cold surfaces outside the product and may form water droplets. >>> This is not an error.

**Metal sounds are heard while the product is warming and cooling.**

- Metal parts may expand and make sounds when heated. >>> This is not an error.

### **The product does not work.**

- Fuse may be faulty or blown. >>> Check the fuses in the fuse box. Change them if necessary or reactivate them.
- The appliance may not be plugged to the (grounded) outlet. >>> Check if the appliance is plugged in to the outlet.
- (If there is timer on your appliance) Keys on the control panel do not work. >>> If your product has a key lock, the key lock may be enabled, disable the key lock.
- If the hob does not turn on when the on/off key is pushed >>> Unplug it and wait at least 20 seconds before plugging it in.
- It has overheat protection. >>> Wait for your hob to cool down.
- Appropriate pots may not be used. >>> Check your pots.

### **Oven light is not on.**

- Oven lamp may be faulty. >>> Replace oven's lamp.
- No electricity. >>> Ensure the mains is operational and check the fuses in the fuse box. Change the fuses if necessary or reactivate them.

### **The symbol on the hob zone display is constantly lit.**

- There may not be a pot on the that hob zone is operating. >>> Check if there is a pot on the hob zone.
- Your pot may not be induction compatible. >>> Check if your pot is suitable for induction hobs.
- The pot may not be centered correctly on the hob zone or the bottom surface of the pot may not be wide enough for the selected hob zone. >>> Center the hob zone by selecting a pot that is wide enough for the hob zone.
- The pot or the hob zone may be very hot. >>> Wait for them to cool down.

### **The selected hob zone suddenly turns off while it is working.**

- The cooking time of the selected zone may have expired. >>> You can set a new cooking time or finish cooking.
- There is overheat protection. >>> Wait for your hob to cool down.

- An object may be covering the touch control panel. >>> Remove the object from the panel.

### **Even though the hob zone is turned on, the pot does not heat up.**

- The pot may not be compatible with the induction hob. >>> Check if your pot is suitable for the induction hob.
- The pot may not be centered correctly on the hob zone or the bottom surface of the pot may not be wide enough for the selected hob zone. >>> Center the hob zone by choosing a pot that is wide enough for the hob zone.

### **The cooling fan continues to run even though the hob is turned off.**

- This is not an error. The cooling fan continues to operate until the electronic equipment inside the hob cools to the appropriate temperature.

### **There is a noise coming from the hob while cooking**

- There may be some noises coming from the hob during cooking. These noises depend on the composition of the cookware. These noises are normal, not a malfunction and are part of induction technology.

### **Possible sounds and causes:**

- **Fan noise:** The hob has a fan that automatically operates according to the temperature of the product. The fan has different operating levels and operates at different levels according to the temperature. After the hob is turned off, if the temperature is high according to the product temperature, the fan may continue to operate for a while.
- **Low hum like transformer operation:** This is the nature of induction technology. Since the heat is transferred directly to the bottom of the cookware, this kind of hum may occur depending on the material of the cookware. Therefore, different sounds may be heard with different cookware.

- **Crackling sound:** This is due to the material and structure of the bottom of the cookware. If the cookware is made of different materials and layers, crackling noise may occur.
- **Whistling sound:** A whistling sound may be heard when cooking on two hob zones on the same side of the hob at different cooking levels.

**(For models with timer) The timer display flashes or the timer symbol is left open.**

- There has been a power outage before.  
>>> Set the time / Turn off the product function knobs and again switch it to the desired position.

**Error codes/reasons and possible solutions**

Error codes	Error reasons	Possible solutions
E1 – E11	An induction hob communication error has occurred.	Turn off the induction hob and turn it back on after 30 seconds. If the error persists, disconnect the product from the power supply and reconnect it. If the problem persists, contact an authorized service.
E 16 - E 21	An induction hob temperature sensor error has occurred.	Turn off the induction hob and turn it back on after 30 seconds. If the error persists, disconnect the product from the power supply and reconnect it. If the problem persists, contact an authorized service.
E22 E26	Induction hob is overheating.	Turn off the induction hob and wait for it to cool down. The error will disappear when the hob temperature drops below the limits. If the problem persists, contact the authorized service.
E23 E24	An induction hob software error has occurred.	Turn off the induction hob and turn it back on after 30 seconds. If the error persists, disconnect the product from the power supply and reconnect it. If the problem persists, contact an authorized service.
E25	An error occurred in the induction hob fan operation.	Turn off the induction hob and turn it back on after 30 seconds. If the problem persists, contact the authorized service.
E27 E47	Induction compatible pots were not used.	The error will disappear when an induction compatible pot is used.
E 31 - E 39	A hardware error has occurred in the induction hob electronic card.	Turn off the induction hob and turn it back on after 30 seconds. If the error persists, disconnect the product from the power supply and reconnect it. If the problem persists, contact an authorized service.
E 42	An electrical connection error has occurred.	Re-establish the correct electrical connection by referring to the product's technical table and installation manual.
E46	One or more keys were held down for more than 10 seconds.  An object was left on the control panel or it was exposed to steam.	Once you take your hand off the hob, the problem will disappear.  Once the control panel is cleaned, the problem will disappear.

Error codes	Error reasons	Possible solutions
E48 E49 E 51	An induction hob sensor error has occurred.	Sensor hardware must be brought into compliance with the conditions of use. If the error persists, disconnect the product from the power supply and reconnect it. If the problem persists, contact an authorized service.
E 52 - E 57	A high temperature error has occurred on the induction hob.	Turn off the induction hob and wait for it to cool down. The error will disappear when the sensor temperature drops below the limits. If the problem persists, contact the authorized service.
E 58 - E 59	A sensor error / high temperature error occurred in automatic cooking mode.	Turn off the induction hob and wait for it to cool down. If the error persists, disconnect the product from the power supply and reconnect it. If the problem persists, contact an authorized service.
E 63	If your product is an induction hob with a hood; a filter error has occurred.	Remove and reattach the ventilation filters. If the problem persists, contact an authorized service.
FF	Any key may have been touched for a long period of time.	When you release any key for a long time,
	A pot may have been placed on the control unit.	When the pot on the control unit is removed,
	Food/liquid may have overflowed onto the control unit.	The error will disappear once the overflowing food/liquid residue is cleaned.