

Microwave Oven

User manual

MS23K3513**



SAMSUNG

Contents

Using this user manual	3	Oven use	12
The following symbols are used in this User Manual:	3	How a microwave oven works	12
Safety instructions	3	Checking that your oven is operating correctly	13
Important safety instructions	3	Cooking/Reheating	13
Correct Disposal of This Product (Waste Electrical & Electronic Equipment)	7	Setting the time	14
Installation	9	Power levels and time variations	14
Accessories	9	Adjusting the cooking time	15
Installation site	9	Stopping the cooking	15
Turntable	9	Setting the energy save mode	15
Maintenance	10	Using the auto cook features	16
Cleaning	10	Using the quick defrost features	18
Replacement (repair)	10	Using the soften/melt features	19
Care against an extended period of disuse	10	Using the favorite features	20
Quick look-up guide	11	To use the favorite setting	20
Oven features	11	Using the deodorization features	20
Oven	11	Using the child lock features	21
Control panel	12	Switching the beeper off	21
		Cookware guide	21
		Cooking guide	22
		Troubleshooting and information code	24
		Troubleshooting	24
		Information code	26
		Technical specifications	27

Using this user manual

You have just purchased a SAMSUNG microwave oven. Your Owner's Instructions contains valuable information on cooking with your microwave oven:

- Safety precautions
- Suitable accessories and cookware
- Useful cooking tips
- Cooking tips

The following symbols are used in this User Manual:

WARNING

Hazards or unsafe practices that may result in **severe personal injury or death**.

CAUTION

Hazards or unsafe practices that may result in **minor personal injury or property damage**.

NOTE

Useful tips, recommendations, or information that helps users manipulate the product.

Safety instructions

IMPORTANT SAFETY INSTRUCTIONS

READ CAREFULLY AND KEEP FOR FUTURE REFERENCE.

WARNING: If the door or door seals are damaged, the oven must not be operated until it has been repaired by a competent person.

WARNING: It is hazardous for anyone other than a competent person to carry out any service or repair operation that involves the removal of a cover which gives protection against exposure to microwave energy.

WARNING: Liquids and other foods must not be heated in sealed containers since they are liable to explode.

WARNING: Only allow children to use the oven without supervision when adequate instructions have been given so that the child is able to use the oven in a safe way and understands the hazards of improper use.

This appliance is intended to be used in household only and it is not intended to be used such as:

- staff kitchen areas in shops, offices and other working environments;
- farm houses;
- by clients in hotels, motels and other residential environments;
- bed and breakfast type environments.

Safety instructions

Only use utensils that are suitable for use in microwave ovens. When heating food in plastic or paper containers, keep an eye on the oven due to the possibility of ignition.

Metallic containers for food and beverages are not allowed during microwave cooking.

The microwave oven is intended for heating food and beverages. Drying of food or clothing and heating of warming pads, slippers, sponges, damp cloth and similar may lead to risk of injury, ignition or fire.

If smoke is observed (emitted), switch off or unplug the appliance and keep the door closed in order to stifle any flames.

Microwave heating of beverages can result in delayed eruptive boiling, therefore care must be taken when handling the container.

The contents of feeding bottles and baby food jars shall be stirred or shaken and the temperature checked before consumption, in order to avoid burns.

Eggs in their shell and whole hard-boiled eggs should not be heated in microwave ovens since they may explode, even after microwave heating has ended.

The oven should be cleaned regularly and any food deposits removed.

Failure to maintain the oven in a clean condition could lead to deterioration of the surface that could adversely affect the life of the appliance and possibly result in a hazardous situation.

The microwave oven is intended to be used on the counter top (freestanding) use only, the microwave oven shall not be placed in a cabinet.

The appliance should not be cleaned with a water jet.

The appliance is not intended for installing in road vehicles, caravans and similar vehicles etc.

This appliance is not intended for use by persons (including children) with reduced physical, sensory or mental capabilities, or lack of experience and knowledge, unless they have been given supervision or instruction concerning use of the appliance by a person responsible for their safety.

Children should be supervised to ensure that they do not play with the appliance.

This appliance can be used by children aged from 8 years and above and persons with reduced physical, sensory or mental capabilities or lack of experience and knowledge if they have been given supervision or instruction concerning use of the appliance in a safe way and understand the hazards involved. Children shall not play with the appliance. Cleaning and user maintenance shall not be made by children without supervision. If the supply cord is damaged, it must be replaced by the manufacturer, its service agent or similarly qualified persons in order to avoid a hazard.

This oven should be positioned proper direction and height permitting easy access to cavity and control area.

Before using the your oven first time, oven should be operated with the water during 10 minute and then used.

If the oven generates a strange noise, a burning smell, or smoke is emitted, unplug the power plug immediately and contact your nearest service center.

The microwave oven has to be positioned so that plug is accessible.

General safety

Any modifications or repairs must be performed by qualified personnel only.

Do not heat food or liquids sealed in containers for the microwave function.

Do not use benzene, thinner, alcohol, or steam or high-pressure cleaners to clean the oven.

Do not install the oven: near a heater or flammable material; locations that are humid, oily, dusty or exposed to direct sunlight or water; or where gas may leak; or an uneven surface.

This oven must be properly grounded in accordance with local and national codes.

Regularly use a dry cloth to remove foreign substances from the power plug terminals and contacts.

Do not pull, excessively bend, or place heavy objects on the power cord.

If there is a gas leak (propane, LP, etc) ventilate immediately. Do not touch the power cord.

Do not touch the power cord with wet hands.

While the oven is operating, do not turn it off by unplugging the power cord.

Do not insert fingers or foreign substances. If foreign substances enter the oven, unplug the power cord and contact a local Samsung service centre.

Do not apply excessive pressure or impact to the oven.

Do not place the oven over fragile objects.

Ensure the power voltage, frequency, and current matches the product specifications.

Firmly plug the power plug into the wall socket. Do not use multiple plug adapters, extension cords, or electric transformers.

Do not hook the power cord on metal objects. Make sure the cord is between objects or behind the oven.

Do not use a damaged power plug, power cord, or loose wall socket. For damaged power plugs or cords, contact a local Samsung service centre.

Do not pour or directly spray water onto the oven.

Do not place objects on the oven, inside, or on the oven door.

Do not spray volatile materials such as insecticide on the oven.



Safety instructions

Do not store flammable materials in the oven. Because alcohol vapours can contact hot parts of the oven, use caution when heating food or drinks containing alcohol. Children may bump themselves or catch their fingers on the door. When opening/closing the door, keep children away.

Microwave warning

Microwave heating of beverages may result in delayed eruptive boiling; always use caution when handling the container. Always allow beverages to stand at least 20 seconds before handling. If necessary, stir during heating. Always stir after heating.

In the event of scalding, follow these First Aid instructions:

1. Immerse the scalded area in cold water for at least 10 minutes.
2. Cover with a clean, dry dressing.
3. Do not apply any creams, oils, or lotions.

To avoid damaging the tray or rack, do not put the tray or rack in water shortly after cooking.

Do not use the oven for deep fat frying because the oil temperature cannot be controlled. This could result in a sudden boil over of hot oils.

Microwave oven precautions

Only use microwave-safe utensils. Do not use metallic containers, gold or silver trimmed dinnerware, skewers, etc.

Remove wire twist ties. Electric arcing may occur.

Do not use the oven to dry papers or clothes.

Use shorter times for small amounts of food to prevent overheating or burning.

Keep the power cord and power plug away from water and heat sources.

To avoid the risk of explosion, do not heat eggs with shells or hard-boiled eggs. Do not heat airtight or vacuum-sealed containers, nuts, tomatoes, etc.

Do not cover the ventilation slots with cloth or paper. This is a fire hazard. The oven may overheat and turn off automatically and will remain off until it cools sufficiently.

Always use oven mitts when removing a dish.

Stir liquids halfway during heating or after heating ends and allow the liquid stand at least 20 seconds after heating to prevent eruptive boiling.

Stand at arms length from the oven when opening the door to avoid getting scalded by escaping hot air or steam.

Do not operate the oven when it is empty. The oven will automatically shut down for 30 minutes for safety purposes. We recommend placing a glass of water inside the oven at all times to absorb microwave energy in case the oven is started accidentally.

Install the oven in compliance with the clearances in this manual. (See Installing your microwave oven.)

Use caution when connecting other electrical appliances to sockets near the oven.

Microwave operation precautions

Failure to observe the following safety precautions may result in harmful exposure to microwave energy.

- Do not operate the oven with the door open. Do not tamper with the safety interlocks (door latches). Do not insert anything into the safety interlock holes.
 - Do not place any object between the oven door and front face or allow food or cleaner residue to accumulate on sealing surfaces. Keep the door and door sealing surfaces clean by wiping with a damp cloth and then with a soft, dry cloth after each use.
 - Do not operate the oven if it is damaged. Only operate after it has been repaired by a qualified technician.
- Important:** the oven door must close properly. The door must not be bent; the door hinges must not be broken or loose; the door seals and sealing surfaces must not be damaged.
- All adjustments or repairs must be done by a qualified technician.



Limited warranty

Samsung will charge a repair fee for replacing an accessory or repairing a cosmetic defect if the damage to the unit or accessory was caused by the customer. Items this stipulation covers include:

- Door, handles, out-panel, or control panel that are dented, scratched, or broken.
- A broken or missing tray, guide roller, coupler, or wire rack.

Use this oven only for its intended purpose as described in this instruction manual. Warnings and Important Safety Instructions in this manual do not cover all possible conditions and situations that may occur. It is your responsibility to use common sense, caution, and care when installing, maintaining, and operating your oven.

Because these following operating instructions cover various models, the characteristics of your microwave oven may differ slightly from those described in this manual and not all warning signs may be applicable. If you have any questions or concerns, contact a local Samsung service centre or find help and information online at www.samsung.com.

Use this oven for heating food only. It is intended for domestic use only. Do not heat any type of textiles or cushions filled with grains. The manufacturer cannot be held liable for damage caused by improper or incorrect use of the oven.

To avoid deterioration of the oven surface and hazardous situations, always keep the oven clean and well maintained.

Product group definition

This product is a Group 2 Class B ISM equipment. The definition of group 2 which contains all ISM equipment in which radio-frequency energy is intentionally generated and/or used in the form of electromagnetic radiation for the treatment of material, and EDM and arc welding equipment.

For Class B equipment is equipment suitable for use in domestic establishments and in establishments directly connected to a low voltage power supply network which supplies buildings used for domestic purposes.

Correct Disposal of This Product (Waste Electrical & Electronic Equipment)

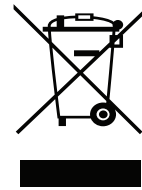

(Applicable in countries with separate collection systems)

This marking on the product, accessories or literature indicates that the product and its electronic accessories (e.g. charger, headset, USB cable) should not be disposed of with other household waste at the end of their working life. To prevent possible harm to the environment or human health from uncontrolled waste disposal, please separate these items from other types of waste and recycle them responsibly to promote the sustainable reuse of material resources.

Household users should contact either the retailer where they purchased this product, or their local government office, for details of where and how they can take these items for environmentally safe recycling.

Business users should contact their supplier and check the terms and conditions of the purchase contract. This product and its electronic accessories should not be mixed with other commercial wastes for disposal.

For information on Samsung's environmental commitments and product specific regulatory obligations e.g. REACH visit: samsung.com/uk/aboutsamsung/samsungelectronics/corporatecitizenship/data_corner.html



Safety instructions

COOKING INSTRUCTIONS ON FOOD PACKAGING

Microwave Symbols

On the front of your oven there is a microwave oven symbol, as shown below.



This symbol has been introduced for your benefit when cooking or reheating packaged food.

Packaged food is also, increasingly, using a microwave symbol similar to the one below. When you see this Symbol on food packaging, cooking instructions are based on either the IEC Power Output Rating, or the Reheating Categories A, B, C, D or E.

COOKING INSTRUCTIONS

The IEC Power Output rating is an internationally standardised rating, so all microwave manufacturers now use the same method of measuring power output. If food packaging gives cooking instructions based on IEC Power ratings, set cooking times according to the IEC Power of your oven.

For example :

If the cooking instructions are based on a 650 W oven, then you will need to reduce some cooking time for the MS23K3513** (800 W).

Ready meals are now very convenient and popular. These are meals which are already prepared and cooked by the food manufacturer, and then frozen, chilled or vacuum sealed for long life.

Increasingly, heating times for such ready meals are being based on the Heating Categories A, B, C, D and E.

On this instance, simply match the heating category of your oven to the instructions on the food package, and set your timer accordingly.

For example :

If the heating instructions are 3 minutes on HIGH for a D category oven, then you will need to set your timer for less than 3 minutes on HIGH for the MS23K3513** (E category).

IMPORTANT: Always remember that cooking instructions are intended only as a guide. If you have followed the instructions and the food is still not piping hot throughout, simply return it to the oven and cook it until it is.



Installation

Accessories

Depending on the model that you have purchased, you are supplied with several accessories that can be used in a variety of ways.

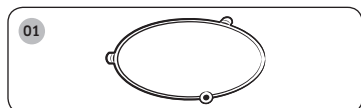

01 Roller ring, to be placed in the centre of the oven.

Purpose: The roller ring supports the turntable.

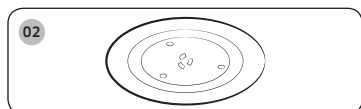

02 Turntable, to be placed on the roller ring with the centre fitting to the coupler.

Purpose: The turntable serves as the main cooking surface; it can be easily removed for cleaning.

IMPORTANT

DO NOT operate the microwave oven without the roller ring and turntable.

Installation site

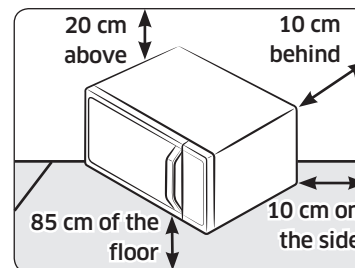

- Select a flat, level surface approx. 85 cm above the floor. The surface must support the weight of the oven.
- Secure room for ventilation, at least 10 cm from the rear wall and both sides, and 20 cm from above.
- Do not install the oven in hot or damp surroundings, such as next to other microwave ovens or radiators.
- Conform to the power supply specifications of this oven. Use only approved extension cables if you need to use.
- Wipe the interior and the door seal with a damp cloth before using your oven for the first time.

Turntable

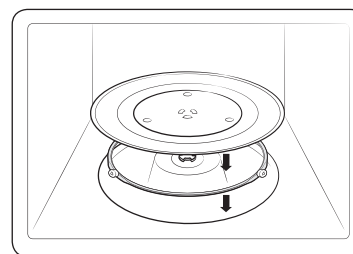

Remove all packing materials inside the oven. Install the roller ring and turntable. Check that the turntable rotates freely.



Maintenance

Cleaning

Clean the oven regularly to prevent impurities from building up on or inside the oven. Also pay special attention to the door, door sealing, and turntable and roller ring (applicable models only).

If the door won't open or close smoothly, first check if the door seals have built up impurities. Use a soft cloth in soapy water to clean both the inner and outer sides of the oven. Rinse and dry well.

To remove stubborn impurities with bad smells from inside the oven

1. With an empty oven, put a cup of diluted lemon juice on the centre of the turntable.
2. Heat the oven for 10 minutes at max power.
3. When the cycle is complete, wait until the oven cools down. Then, open the door and clean the cooking chamber.

To clean inside swing-heater models

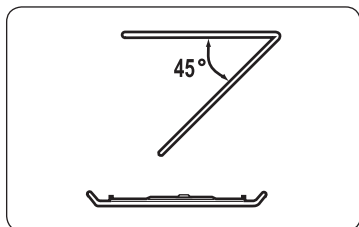

To clean the upper area of the cooking chamber, lower the top heating element by 45° as shown. This will help clean the upper area. When done, reposition the top heating element.

⚠ CAUTION

- Keep the door and door sealing clean and ensure the door opens and closes smoothly. Otherwise, the oven's lifecycle may be shortened.
- Take caution not to spill water into the oven vents.
- Do not use any abrasive or chemical substances for cleaning.
- After each use of the oven, use a mild detergent to clean the cooking chamber after waiting for the oven to cool down.

Replacement (repair)

⚠ WARNING

This oven has no user-removable parts inside. Do not try to replace or repair the oven yourself.

- If you encounter a problem with hinges, sealing, and/or the door, contact a qualified technician or a local Samsung service centre for technical assistance.
- If you want to replace the light bulb, contact a local Samsung service centre. Do not replace it yourself.
- If you encounter a problem with the outer housing of the oven, first unplug the power cord from the power source, and then contact a local Samsung service centre.

Care against an extended period of disuse

- If you don't use the oven for an extended period of time, unplug the power cord and move the oven to a dry, dust-free location. Dust and moisture that builds up inside the oven may affect the performance of the oven.



Quick look-up guide

If you want to cook some food.



Place the food in the oven. Press the **START/+30s** button.

Result: Cooking starts. When it has finished.

- 1) The oven beeps 4 times.
- 2) The end reminder signal will beep 3 times (once every minute).
- 3) The current time is displayed again.

If you want to add an extra 30 seconds.

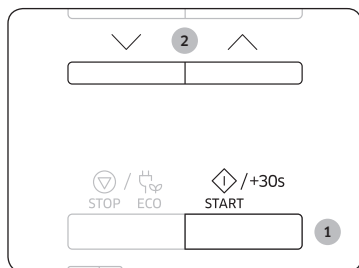

1. Press the **START/+30s** button one or more times for each extra 30 seconds that you wish to add.
2. By pressing the **Up** or **Down** button, you can set the time as you want.

Oven features

Oven

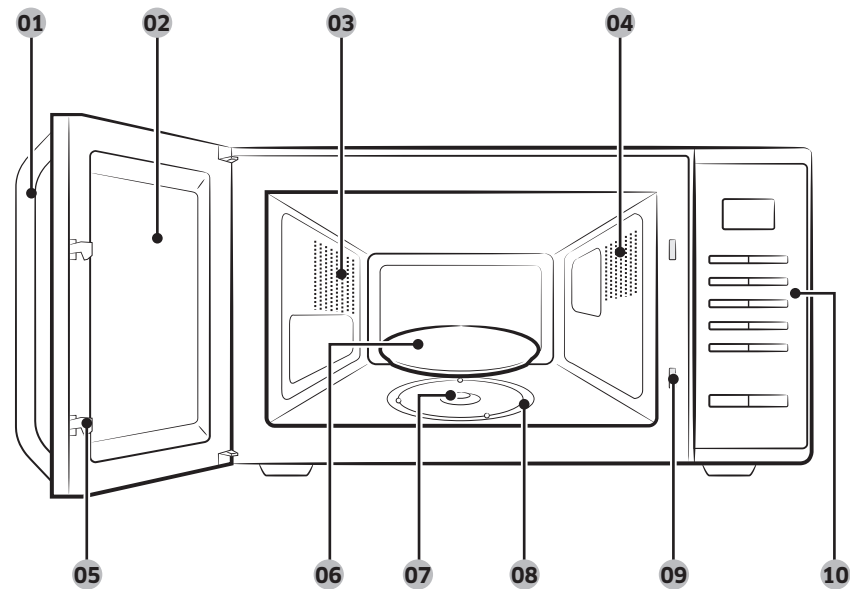

- | | | |
|-------------------------|------------------------|----------------------------------|
| 01 Door handle | 02 Door | 03 Ventilation holes |
| 04 Light | 05 Door latches | 06 Turntable |
| 07 Coupler | 08 Roller ring | 09 Safety interlock holes |
| 10 Control panel | | |

Oven features

Control panel

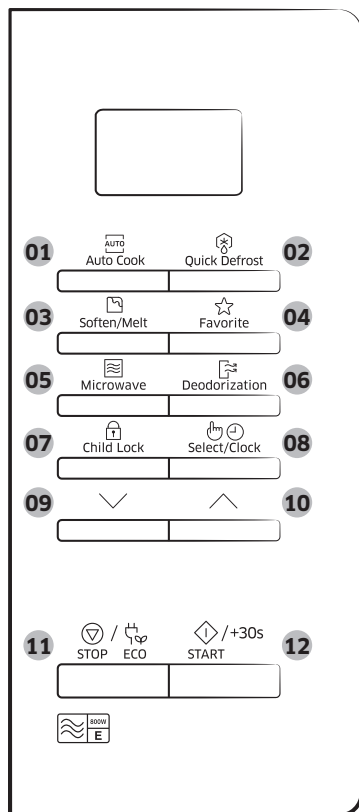

- 01** Auto Cook Button
- 02** Quick Defrost Button
- 03** Soften/Melt Button
- 04** Favorite Button
- 05** Microwave Button
- 06** Deodorization Button
- 07** Child Lock Button
- 08** Select/Clock Button
- 09** Down Button
- 10** Up Button
- 11** Stop/Eco Button
- 12** Start/+30s Button

Oven use

How a microwave oven works

Microwaves are high-frequency electromagnetic waves; the energy released enables food to be cooked or reheated without changing either the form or the colour.

You can use your microwave oven to:

- Defrost
- Reheat
- Cook

Cooking principle.

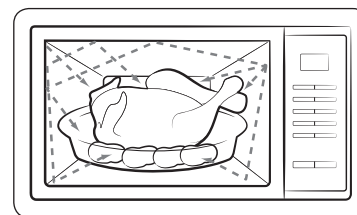

- 1.** The microwaves generated by the magnetron reflected at cavity and are distributed uniformly as the food rotates on the turntable. The food is thus cooked evenly.
- 2.** The microwaves are absorbed by the food up to a depth of about 1 inch (2.5 cm). Cooking then continues as the heat is dissipated within the food.
- 3.** Cooking times vary according to the container used and the properties of the food:
 - Quantity and density
 - Water content
 - Initial temperature (refrigerated or not)

IMPORTANT

As the centre of the food is cooked by heat dissipation, cooking continues even when you have taken the food out of the oven. Standing times specified in recipes and in this booklet must therefore be respected to ensure:

- Even cooking of the food right to the centre.
- The same temperature throughout the food.

Checking that your oven is operating correctly

The following simple procedure enables you to check that your oven is working correctly at all times. If you are in doubt, refer to the section entitled "Troubleshooting" on the page 24 to 26.

NOTE

The oven must be plugged into an appropriate wall socket. The turntable must be in position in the oven. If a power level other than the maximum (100 % - 800 W) is used, the water takes longer to boil.

Open the oven door by pulling the handle on the upper side of the door. Place a glass of water on the turntable. Close the door.



Press the **START/+30s** button and set the time to 4 or 5 minutes, by pressing the **START/+30s** button the appropriate number of times.

Result: The oven heats the water for 4 or 5 minutes.
The water should then be boiling.

Cooking/Reheating

The following procedure explains how to cook or reheat food.

IMPORTANT

ALWAYS check your cooking settings before leaving the oven unattended.

Open the door. Place the food in the centre of the turntable. Close the door. Never switch the microwave oven on when it is empty.



1. Press the **Microwave** button.

Result: The 800 W (Maximum cooking power) indications are displayed:
 (microwave mode)

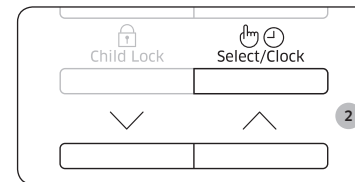

2. Select the appropriate power level by pressing the **Up** or **Down** button. (Refer to the power level table.) And then press the **Select/Clock** button.



3. Set the cooking time by pressing the **Up** or **Down** button.

Result: The cooking time is displayed.

4. Press the **START/+30s** button.

Result: The oven light comes on and the turntable starts rotating. Cooking starts and when it has finished.

1) The oven beeps 4 times.

2) The end reminder signal will beep 3 times (once every minute).

3) The current time is displayed again.

Oven use

Setting the time

When power is supplied, “88:88” and then “12:00” is automatically displayed on the display.

Please set the current time. The time can be displayed in either the 24-hour or 12-hour notation. You must set the clock:

- When you first install your microwave oven
- After a power failure

NOTE

Do not forget to reset the clock when you switch to and from summer and winter time.



1. Press the **Select/Clock** button.

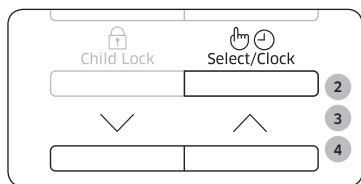

2. Set the 24-hour or 12-hour notation by pressing the **Up** or **Down** button. And then press the **Select/Clock** button.
3. Press the **Up** or **Down** button to set the hour. And then press the **Select/Clock** button.

4. Press the **Up** or **Down** button to set the minute.



5. When the right time is displayed, press the **Select/Clock** button to start the clock.
Result: The time is displayed whenever you are not using the microwave oven.

Power levels and time variations

The power level function enables you to adapt the amount of energy dissipated and thus the time required to cook or reheat your food, according to its type and quantity. You can choose between six power levels.

Power level	Percentage	Output
HIGH	100 %	800 W
MEDIUM HIGH	75 %	600 W
MEDIUM	56 %	450 W
MEDIUM LOW	38 %	300 W
DEFROST	23 %	180 W
LOW	13 %	100 W

The cooking times given in recipes and in this booklet correspond to the specific power level indicated.

If you select a...	Then the cooking time must be...
Higher power level	Decreased
Lower power level	Increased

Adjusting the cooking time

You can increase the cooking time by pressing the **START/+30s** button once for each 30 seconds to be added.

- Check how cooking is progressing at any time simply by opening the door
- Increase the remaining cooking time



Method 1

To increase the cooking time of your food during cooking, press the **START/+30s** button once for each 30 seconds that you wish to add.

- Example: To add three minutes, press the **START/+30s** button six times.

Method 2

Just pressing the **Up** or **Down** button to adjust cooking time.

Stopping the cooking

You can stop cooking at any time so that you can:

- Check the food
- Turn the food over or stir it
- Leave it to stand

To stop the cooking...	Then...
Temporarily	Open the door or press the STOP/ECO button once. Result: Cooking stops. To resume cooking, close the door again and press the START/+30s button.
Completely	Press the STOP/ECO button once. Result: Cooking stops. If you wish to cancel the cooking settings, press the STOP/ECO button again.

Setting the energy save mode

The oven has an energy save mode.



- Press the **STOP/ECO** button.
Result: Display off.
- To remove energy save mode, open the door or press the **STOP/ECO** button and then display shows current time. The oven is ready for use.

NOTE

Auto energy saving function

If you do not select any function when appliance is in the middle of setting or operating with temporary stop condition, function is canceled and clock will be displayed after 25 minutes.

Oven Lamp will be turned off after 5 minutes with door open condition.

Oven use

Using the auto cook features

The **Auto Cook** features has 20 pre-programmed cooking times. You do not need to set either the cooking times or the power level.

You can adjust the type of the serving by pressing the **Up** or **Down** button.

IMPORTANT

Use only recipients that are microwave-safe.

First, place the food in the centre of the turntable and close the door.



1. Press the **Auto Cook** button.

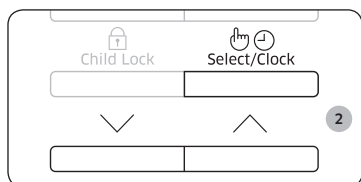

2. Select the type of food that you are cooking by pressing the **Up** or **Down** button. And then press the **Select/Clock** button.

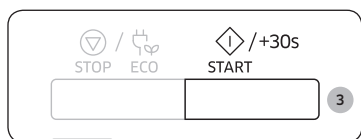

3. Press the **START/+30s** button.

Result: The food is cooked according to the pre-programmed setting selected.

- 1) The oven beeps 4 times.
- 2) The end reminder signal will beep 3 times (once every minute).
- 3) The current time is displayed again.

The following table presents quantities and appropriate instructions about 20 pre-programmed cooking options. Those programmes are running with microwave energy only.

Code/Food	Serving size	Instructions
1 Chilled Ready Meal	300-350 g	Put on a ceramic plate and cover with microwave cling film. This programme is suitable for meals consisting of 3 components (e.g. meat with sauce, vegetables and a side dishes like potatoes, rice or pasta). Stand for 2-3 minutes.
2 Chilled Ready Meal	400-450 g	
3 Chilled Vegetarian Meal	300-350 g	Put meal on a ceramic plate and cover with microwave cling film. This programme is suitable for meals consisting of 2 components (e.g. spaghetti with sauce or rice with vegetables). Stand for 2-3 minutes.
4 Chilled Vegetarian Meal	400-450 g	
5 Broccoli	250 g	Rinse and clean fresh broccoli and prepare florets. Put them evenly into a glass bowl with lid. Add 30 ml (2 tbsp) water when cooking for 250 g. Put bowl in the centre of turntable. Cook covered. Stir after cooking. Stand for 1-2 minutes.
6 Carrots	250 g	Rinse and clean carrots and prepare even slices. Put them evenly into a glass bowl with lid. Add 30 ml (2 tbsp) water when cooking for 250 g. Put bowl in the centre of turntable. Cook covered. Stir after cooking. Stand for 1-2 minutes.
7 Green Beans	250 g	Rinse and clean green beans. Put them evenly into a glass bowl with lid. Add 30 ml (2 tbsp) water when cooking 250 g. Put bowl in the centre of turntable. Cook covered. Stir after cooking. Stand for 1-2 minutes.

Code/Food	Serving size	Instructions
8 Spinach	150 g	Rinse and clean spinach. Put into a glass bowl with lid. Do not add water. Put bowl in the centre of turntable. Cook covered. Stir after cooking. Stand for 1-2 minutes.
9 Corn on the Cob	250 g	Rinse and clean corn on the cob and put into an oval glass dish. Cover with microwave cling film and pierce film. Stand for 1-2 minutes.
10 Peeled Potatoes	250 g	Wash and peel the potatoes and cut into a similar size. Put them into a glass bowl with lid. Add 45-60 ml (3-4 tbsp) water. Put bowl in the centre of turntable. Cook covered. Stand for 2-3 minutes.
11 Brown Rice	125 g	Use a large glass ovenware dish with lid. Add double quantity of cold water (250 ml). Cook covered. Stir before standing time and add salt and herbs. Stand for 5-10 minutes.
12 Wholemeal Macaroni	125 g	Use a large glass ovenware dish with lid. Add 500 ml hot boiling water, a pinch of salt and stir well. Cook uncovered. Stir before standing time and drain thoroughly afterwards. Stand for 1 minutes.
13 Quinoa	125 g	Use a large glass ovenware dish with lid. Add double quantity of cold water (250 ml). Cook covered. Stir before standing time and add salt and herbs. Stand for 1-3 minutes.
14 Bulgur	125 g	Use a large glass ovenware dish with lid. Add double quantity of cold water (250 ml). Cook covered. Stir before standing time and add salt and herbs. Stand for 2-5 minutes.

Code/Food	Serving size	Instructions
15 Chicken Breasts	300 g	Rinse pieces and put on a ceramic plate. Cover with microwave cling film. Pierce film. Put dish on turntable. Stand for 2 minutes.
16 Turkey Breasts	300 g	Rinse pieces and put on a ceramic plate. Cover with microwave cling film. Pierce film. Put dish on turntable. Stand for 2 minutes.
17 Fresh Fish Fillets	300 g	Rinse fish and put on a ceramic plate, add 1 tbsp lemon juice. Cover with microwave cling film. Pierce film. Put dish on turntable. Stand for 1-2 minutes.
18 Fresh Salmon Fillets	300 g	Rinse fish and put on a ceramic plate, add 1 tbsp lemon juice. Cover with microwave cling film. Pierce film. Put dish on turntable. Stand for 1-2 minutes.
19 Fresh Prawns	250 g	Rinse prawns on a ceramic plate, add 1 tbsp lemon juice. Cover with microwave cling film. Pierce film. Put dish on turntable. Stand for 1-2 minutes.
20 Fresh Trout	200 g	Put 1 fresh whole fish into an ovenproof dish. Add a pinch salt, 1 tbsp lemon juice and herbs. Cover with microwave cling film. Pierce film. Put dish on turntable. Stand for 2 minutes.

Oven use

Using the quick defrost features

The **Quick Defrost** features enable you to defrost meat, poultry, fish, frozen vegetable and frozen bread. The defrost time and power level are set automatically. You simply select the programme and the weight.

NOTE

Use only containers that are microwave-safe.

Open the door. Place the frozen food on a ceramic in the centre of the turntable. Close the door.

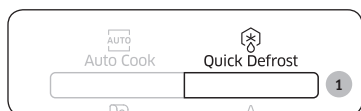

1. Press the **Quick Defrost** button.

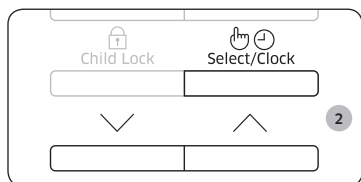

2. Select the type of food that you are cooking by pressing the **Up** or **Down** button. And then press the **Select/Clock** button.

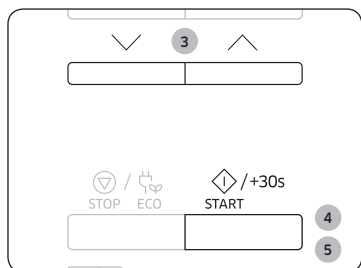

3. Select the size of the serving by pressing the **Up** or **Down** button. (Refer to the table on the side.)

4. Press the **START/+30s** button.

Result:

- Defrosting begins.
- The oven beeps through defrosting to remind you to turn the food over.

5. Press the **START/+30s** button again to finish defrosting.

Result:

- 1) The oven beeps 4 times.
- 2) The end reminder signal will beep 3 times (once every minute).
- 3) The current time is displayed again.

The following table presents the various **Quick Defrost** programmes, serving size, standing times and appropriate instructions. Remove all kind of package material before defrosting. Place meat, poultry, fish, vegetable and bread on a flat glass dish or ceramic plate.

Code/Food	Serving size	Instructions
1 Meat	200-1500 g	Shield the edges with aluminium foil. Turn the meat over, when the oven beeps. This programme is suitable for beef, lamb, pork, steaks, chops, minced meat. Stand for 20-60 minutes.
2 Poultry	200-1500 g	Shield the leg and wing tips with aluminium foil. Turn the poultry over, when the oven beeps. This programme is suitable for whole chicken as well as for chicken portions. Stand for 20-60 minutes.
3 Fish	200-1500 g	Shield the tail of a whole fish with aluminium foil. Turn the fish over, when the oven beeps. This programme is suitable for whole fishes as well as for fish fillets. Stand for 20-60 minutes.
4 Vegetable	200-1500 g	Spread frozen vegetable evenly into a flat glass dish. Turn over or stir the frozen vegetable, when the oven beeps. This programme is suitable for all kind of frozen vegetable. Stand for 5-20 minutes.
5 Bread	200-1500 g	Put bread horizontally on a piece of kitchen paper and turn over, as soon as the oven beeps. Place cake on a ceramic plate and if possible, turn over, as soon as the oven beeps. (Oven keeps operating and is stopped, when you open the door.) This programme is suitable for all kinds of bread, sliced or whole, as well as for bread rolls and baguettes. Arrange bread rolls in a circle. This programme is suitable for all kinds of yeast cake, biscuit, cheese cake and puff pastry. It is not suitable for short/ crust pastry, fruit and cream cakes as well as for cake with chocolate topping. Stand for 10- 30 minutes.

Using the soften/melt features

The **Soften/Melt** features has 4 pre-programmed cooking times. You do not need to set either the cooking times or the power level. You can adjust the number of servings by pressing the **Up** or **Down** button.

First, place the food in the centre of the turntable and close the door.

NOTE

Use only containers that are microwave safe.

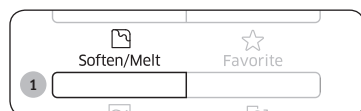

1. Press the **Soften/Melt** button.

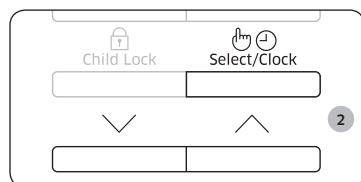

2. Select the type of food that you are cooking by pressing the **Up** or **Down** button. And then press the **Select/Clock** button.



3. Select the size of the serving by pressing the **Up** or **Down** button. (Refer to the table on the side.)
4. Press the **START/+30s** button.

Result: The food is cooked according to the preprogrammed setting selected.

- 1) The oven beeps 4 times.
- 2) The end reminder signal will beep 3 times (once every minute).
- 3) The current time is displayed again.

The following table presents the **Soften/Melt** programmes, quantities and appropriate instructions. Those programmes are running with microwave energy only.

Code/Food	Serving Size	Instructions
1 Melt Butter	50 g 100 g	Cut butter into 3 or 4 pieces and Put them on small glass bowl. Melt uncovered. Stir after cooking. Stand for 1-2 minutes.
2 Melt Dark Chocolate	50 g 100 g	Grate dark chocolate and put in small glass bowl. Melt uncovered. Stir after melting. Stand for 1-2 minutes.
3 Melt Sugar	25 g 50 g	Put sugar on small glass bowl. Add 10 ml water for 25 g and add 20 ml water for 50 g. Melt uncovered. Take out carefully, use oven gloves! Use spoon or fork and pour caramel decorations on baking paper. Let stand for 10 minutes until dry and remove from paper.
4 Soften Butter	50 g 100 g	Cut butter into 3 or 4 pieces and Put them in small glass bowl. Soften uncovered. Stand for 1-2 minutes.

Oven use

Using the favorite features

If you often cook or reheat the same types of dishes, you can store the cooking times and power levels in the oven's memory, so that you do not have to reset them each order.

You can store two different setting.

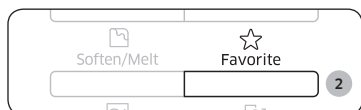

1. Set your cooking programme as usual (cooking time and power level) see Cooking/Reheating page again if necessary.

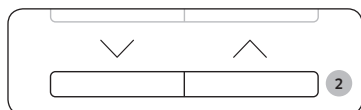

2. Press **Favorite** button, then select the program that you want to save by pressing the **Up** or **Down** button.
P1 : First setting
P2 : Second setting



3. Press the **Select/Clock** button to finish the setting. Or, press the **START/+30s** button to start the program immediately.
Result: Your setting are now stored in the oven's memory.

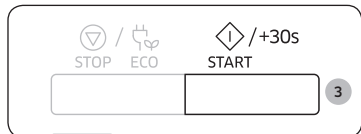

Information

Example : If you want to store Microwave mode, Power 600 W and 3 minutes on P1.

1. Press the **Microwave** button.
2. Set the power 600 W by pressing the **Up** or **Down** button. And then press the **Select/Clock** button.
3. Set the cooking time 3 minutes by pressing the **Up** or **Down** button.
4. Press **Favorite** button, then select the P1.
5. Press the **Select/Clock** or **START/+30s** button to finish the setting.

To use the favorite setting

First, place the food in the centre of the turntable and close the door.



1. Press **Favorite** button, then select the program by pressing the **Up** or **Down** button.

P1 : First setting
P2 : Second setting

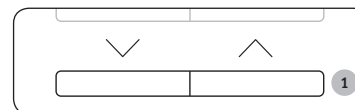

2. Press the **START/+30s** button.

Result: The food is cooked as requested.



Using the deodorization features

Use this features after cooking odorous food or when there is a lot of smoke in the oven interior.

First clean the oven interior.



Press the **Deodorization** button after you have finished cleaning. As soon as you press the **Deodorization** button, the operation will start automatically. when it has finished, the oven beeps four times.

NOTE

The deodorization time has been specified as 5 minutes. It increases by 30 seconds whenever the **START/+30s** button is pressed.

NOTE

The maximum deodorization time is 15 minutes.



Using the child lock features

Your microwave oven is fitted with a special child lock programme, which enables the oven to be “locked” so that children or anyone unfamiliar with it cannot operate it accidentally.



1. Press the **Child Lock** button for 3 seconds.

Result:

- The oven is locked (no functions can be selected).
- The display shows “L”.



2. To unlock the oven, press the **Child Lock** button for 3 seconds.

Result: The oven can be used normally.

Switching the beeper off

You can switch the beeper off whenever you want.

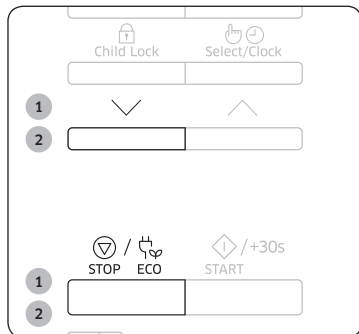

1. Press the **Down** and **STOP/ECO** button at the same time.

Result: The oven does not beep to indicate the end of a function.

2. To switch the beeper back on, press the **Down** and **STOP/ECO** button again at the same time.

Result: The oven operates normally.

Cookware guide

To cook food in the microwave oven, the microwaves must be able to penetrate the food, without being reflected or absorbed by the dish used.

Care must therefore be taken when choosing the cookware. If the cookware is marked microwave-safe, you do not need to worry.

The following table lists various types of cookware and indicates whether and how they should be used in a microwave oven.

Cookware	Microwave-safe	Comments
Aluminum foil	✓X	Can be used in small quantities to protect areas against overcooking. Arcing can occur if the foil is too close to the oven wall or if too much foil is used.
Crust plate	✓	Do not preheat for more than 8 minutes.
China and earthenware	✓	Porcelain, pottery, glazed earthenware and bone china are usually suitable, unless decorated with a metal trim.
Disposable polyester cardboard dishes	✓	Some frozen foods are packaged in these dishes.
Fast-food packaging		
• Polystyrene cups containers	✓	Can be used to warm food. Overheating may cause the polystyrene to melt.
• Paper bags or newspaper	X	May catch fire.
• Recycled paper or metal trims	X	May cause arcing.
Glassware		
• Oven-to-tableware	✓	Can be used, unless decorated with a metal trim.
• Fine glassware	✓	Can be used to warm foods or liquids. Delicate glass may break or crack if heated suddenly.
• Glass jars	✓	Must remove the lid. Suitable for warming only.



Cookware guide

Cookware	Microwave-safe	Comments
Metal		
• Dishes	✗	May cause arcing or fire.
• Freezer bag twist ties	✗	
Paper		
• Plates, cups, napkins and kitchen paper	✓	For short cooking times and warming. Also to absorb excess moisture.
• Recycled paper	✗	
Plastic		
• Containers	✓	Particularly if heat-resistant thermoplastic. Some other plastics may warp or discolour at high temperatures. Do not use Melamine plastic.
• Cling film	✓	
• Freezer bags	✓✗	
Wax or grease-proof paper	✓	Can be used to retain moisture and prevent spattering.

✓ : Recommended ✓✗ : Use caution ✗ : Unsafe

Cooking guide

Microwaves

Microwave energy actually penetrates food, attracted and absorbed by its water, fat and sugar content.

The microwaves cause the molecules in the food to move rapidly. The rapid movement of these molecules creates friction and the resulting heat cooks the food.

Cooking

Cookware for microwave cooking:

Cookware must allow microwave energy to pass through it for maximum efficiency. Microwaves are reflected by metal, such as stainless steel, aluminium and copper, but they can penetrate through ceramic, glass, porcelain and plastic as well as paper and wood. So food must never be cooked in metal containers.

Food suitable for microwave cooking:

Many kinds of food are suitable for microwave cooking, including fresh or frozen vegetables, fruit, pasta, rice, grains, beans, fish, and meat. Sauces, custard, soups, steamed puddings, preserves, and chutneys can also be cooked in a microwave oven. Generally speaking, microwave cooking is ideal for any food that would normally be prepared on a hob. Melting butter or chocolate, for example (see the chapter with tips, techniques and hints).

Covering during cooking

To cover the food during cooking is very important, as the evaporated water rises as steam and contributes to cooking process. Food can be covered in different ways: e.g. with a ceramic plate, plastic cover or microwave suitable cling film.

Standing times

After cooking is over food the standing time is important to allow the temperature to even out within the food.

Reheating Liquids and Food

Use the power levels and times in this table as a guide lines for reheating.

Food	Serving Size	Power	Time (min.)
Drinks (Coffee, Tea and Water)	150 ml (1 cup) 250 ml (1 mug)	800 W	1-1½ 1½-2
	Instructions Pour into cup and reheat uncovered. Put cup/ mug in the centre of turntable. Keep in microwave oven during standing time and stir well. Stand for 1-2 minutes.		
Soup (Chilled)	250 g	800 W	3-3½
	Instructions Pour into a deep ceramic plate. Cover with plastic lid. Stir well after reheating. Stir again before serving. Stand for 2-3 minutes.		
Stew (Chilled)	350 g	600 W	5½-6½
	Instructions Put stew in a deep ceramic plate. Cover with plastic lid. Stir occasionally during reheating and again before standing and serving. Stand for 2-3 minutes.		
Pasta with Sauce (Chilled)	350 g	600 W	4½-5½
	Instructions Put pasta (e.g. spaghetti or egg noodles) on a flat ceramic plate. Cover with microwave cling film. Stir before serving. Stand for 3 minutes.		
Filled Pasta with Sauce (Chilled)	350 g	600 W	5-6
	Instructions Put filled pasta (e.g. ravioli, tortellini) in a deep ceramic plate. Cover with plastic lid. Stir occasionally during reheating and again before standing and serving. Stand for 3 minutes.		

Food	Serving Size	Power	Time (min.)
Plated Meal (Chilled)	350 g	600 W	5½-6½
	Instructions Plate a meal of 2-3 chilled components on a ceramic dish. Cover with microwave cling-film. Stand for 3 minutes.		
Pasta (Frozen) (Cannelloni, Macaroni, Lasagne)	400 g	450 W	16-16½
	Instructions Put frozen pasta into a small flat rectangular glass pyrex dish. Put the dish directly on the turntable. Stand for 2-3 minutes.		

Troubleshooting and information code

Troubleshooting

If you have any of the problems listed below try the solutions given.

Problem	Cause	Action
General		
The buttons cannot be pressed properly.	Foreign matter may be caught between the buttons.	Remove the foreign matter and try again.
	For touch models: Moisture is on the exterior.	Wipe the moisture from the exterior.
	Child lock is activated.	Deactivate Child lock.
The time is not displayed.	The Eco (power-saving) function is set.	Turn off the Eco function.
The oven does not work.	Power is not supplied.	Make sure power is supplied.
	The door is open.	Close the door and try again.
	The door open safety mechanisms are covered in foreign matter.	Remove the foreign matter and try again.
The oven stops while in operation.	The user has opened the door to turn food over.	After turning over the food, press the Start button again to start operation.

Problem	Cause	Action
The power turns off during operation.	The oven has been cooking for an extended period of time.	After cooking for an extended period of time, let the oven cool.
	The cooling fan is not working.	Listen for the sound of the cooling fan.
	Trying to operate the oven without food inside.	Put food in the oven.
	There is not sufficient ventilation space for the oven.	There are intake/exhaust outlets on the front and rear of the oven for ventilation. Keep the gaps specified in the product installation guide.
	Several power plugs are being used in the same socket.	Designate only one socket to be used for the oven.
There is a popping sound during operation, and the oven doesn't work.	Cooking sealed food or using a container with a lid may causes popping sounds.	Do not use sealed containers as they may burst during cooking due to expansion of the contents.
The oven exterior is too hot during operation.	There is not sufficient ventilation space for the oven.	There are intake/exhaust outlets on the front and rear of the oven for ventilation. Keep the gaps specified in the product installation guide.
	Objects are on top of the oven.	Remove all objects on the top of the oven.
The door cannot be opened properly.	Food residue is stuck between the door and oven interior.	Clean the oven and then open the door.



Problem	Cause	Action
Heating including the Warm function does not work properly.	The oven may not work, too much food is being cooked, or improper cookware is being used.	Put one cup of water in a microwave-safe container and run the microwave for 1-2 minutes to check whether the water is heated. Reduce the amount of food and start the function again. Use a cooking container with a flat bottom.
The thaw function does not work.	Too much food is being cooked.	Reduce the amount of food and start the function again.
The interior light is dim or does not turn on.	The door has been left open for a long time.	The interior light may automatically turn off when the Eco function operates. Close and reopen the door or press the Cancel button.
	The interior light is covered by foreign matter.	Clean the inside of the oven and check again.
A beeping sound occurs during cooking.	If the Auto Cook function is being used, this beeping sound means it's time to turn over the food during thawing.	After turning over the food, press the Start button again to restart operation.
The oven is not level.	The oven is installed on an uneven surface.	Make sure the oven is installed on flat, stable surface.
There are sparks during cooking.	Metal containers are used during the oven/thawing functions.	Do not use metal containers.

Problem	Cause	Action
When power is connected, the oven immediately starts to work.	The door is not properly closed.	Close the door and check again.
There is electricity coming from the oven.	The power or power socket is not properly grounded.	Make sure the power and power socket are properly grounded.
<ol style="list-style-type: none"> 1. Water drips. 2. Steam emits through a door crack. 3. Water remains in the oven. 	There may be water or steam in some cases depending on the food. This is not an oven malfunction.	Let the oven cool and then wipe with a dry dish towel.
The brightness inside the oven varies.	Brightness changes depending on power output changes according to function.	Power output changes during cooking are not malfunctions. This is not an oven malfunction.
Cooking is finished, but the cooling fan is still running.	To ventilate the oven, the cooling fan continues to run for about 3 minutes after cooking is complete.	This is not an oven malfunction.



Troubleshooting and information code

Problem	Cause	Action
Turntable		
While turning, the turntable comes out of place or stops turning.	There is no roller ring, or the roller ring is not properly in place.	Install the roller ring and then try again.
The turn table drags while turning.	The roller ring is not properly in place, there is too much food, or the container is too large and touches the inside of the microwave.	Adjust the amount of food and do not use containers that are too large.
The turn table rattles while turning and is noisy.	Food residue is stuck to the bottom of the oven.	Remove any food residue stuck to the bottom of the oven.

Information code

Information code	CAUSE	Action
C-d0	Control buttons are pressed over 10 seconds.	Clean the keys and check if there is water on the surface around key. If it occurs again, turn off the microwave oven over 30 seconds and try setting again. If it appears again, call your local SAMSUNG Customer Care Centre.

NOTE

If the suggested solution does not solve the problem, contact your local SAMSUNG Customer Care Centre.

Technical specifications

SAMSUNG strives to improve its products at all times. Both the design specifications and these user instructions are thus subject to change without notice.

Model	MS23K3513**
Power source	230 V ~ 50 Hz AC
Power consumption Microwave	1150 W
Output power	100 W / 800 W - 6 levels (IEC-705) <ul style="list-style-type: none">• 240 V: 800 W• 230 V: 750 W
Operating frequency	2450 MHz
Dimensions (W x H x D) Outside (Include Handle) Oven cavity	489 x 275 x 374 mm 330 x 211 x 324 mm
Volume	23 liter
Weight Net	12.0 kg approx.

Memo

Please be advised that the Samsung warranty does NOT cover service calls to explain product operation, correct improper installation, or perform normal cleaning or maintenance.

QUESTIONS OR COMMENTS?

COUNTRY	CALL	OR VISIT US ONLINE AT
AUSTRIA	0800-SAMSUNG (0800-7267864) [Only for Premium HA] 0800-366661 [Only for Dealers] 0810-112233	www.samsung.com/at/support
BELGIUM	02-201-24-18	www.samsung.com/be/support (Dutch) www.samsung.com/be_fr/support (French)
DENMARK	70 70 19 70	www.samsung.com/dk/support
FINLAND	030-6227 515	www.samsung.com/fi/support
FRANCE	01 48 63 00 00	www.samsung.com/fr/support
GERMANY	0180 6 SAMSUNG bzw. 0180 6 7267864* (*0,20 €/Anruf aus dem dt. Festnetz, aus dem Mobilfunk max. 0,60 €/Anruf)	www.samsung.com/de/support
ITALIA	800-SAMSUNG (800.7267864)	www.samsung.com/it/support
CYPRUS	8009 4000 only from landline, toll free	www.samsung.com/gr/support
GREECE	80111-SAMSUNG (80111 726 7864) only from land line (+30) 210 6897691 from mobile and land line	
LUXEMBURG	261 03 710	www.samsung.com/be_fr/support
NETHERLANDS	0900-SAMSUNG (0900-7267864) (€ 0,10/Min)	www.samsung.com/nl/support
NORWAY	815 56480	www.samsung.com/no/support
PORTUGAL	808 20 7267	www.samsung.com/pt/support
SPAIN	0034902172678	www.samsung.com/es/support
SWEDEN	0771 726 7864 (0771-SAMSUNG)	www.samsung.com/se/support
SWITZERLAND	0800 726 78 64 (0800-SAMSUNG)	www.samsung.com/ch/support (German) www.samsung.com/ch_fr/support (French)
UK	0330 SAMSUNG (7267864)	www.samsung.com/uk/support
EIRE	0818 717100	www.samsung.com/ie/support



DE68-04431H-00