

18V
**Pole Hedge
Trimmer**

S18EHP

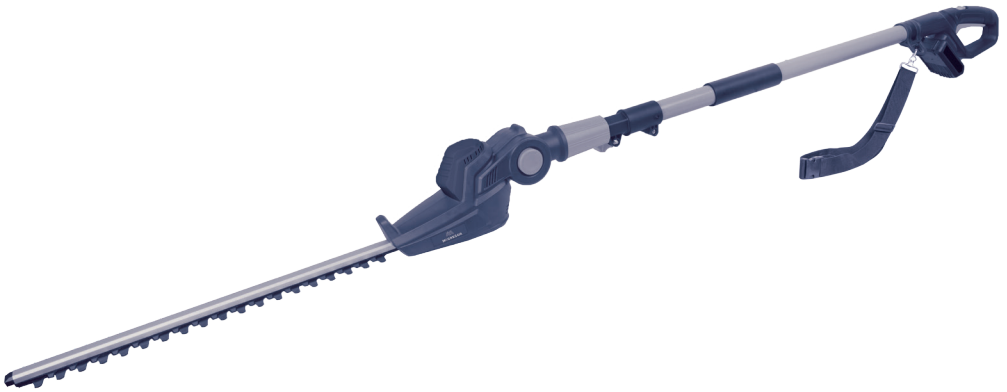

**Important - Please read these instructions
fully before starting assembly**

These instructions contain important information that will help you get the best from your pole hedge trimmer, ensuring it is assembled correctly and safely. If you need help or have damaged or missing parts, call the Customer Helpline on 0345 605 2069

**AFTER SALES SUPPORT
0345 605 2069**

SPEAR & JACKSON SINCE 1760

For more than 250 years gardeners have enjoyed high quality performance and great results using Spear & Jackson tools.

Our garden power tools combine continuous innovation and the latest in manufacturing technologies with a proud heritage.

Each product is carefully designed with performance, comfort and durability firmly in mind, which has earned Spear & Jackson an enviable reputation as a maker of tools to trust.

3 YEARS GUARANTEE

As a testament to the quality of our products, we offer a 3 year manufacturers warranty and a comprehensive after sales service.

The warranty covers manufacturing faults, however in the event that the item has been deliberately damaged, used in a commercial environment or disassembled then the warranty will be null and void.

Please retain proof of purchase.

7 DAYS A WEEK TECHNICAL SUPPORT

We want you to get the best out of your products. Our easy-to-read instruction manual guides you with best practice use and maintenance tips. Please call 0345 605 2069 for technical support, we can solve around 80% of questions directly over the phone.

We hope you enjoy your product and we look forward to any feedback, as this allows us to develop even better products for the future.

CONTENTS

Safety information -----	04
Box content / parts -----	14
Assemble -----	15
Prepare -----	17
Operate -----	18
Maintenance-----	19
Technical data -----	20
Troubleshooting -----	22
Environmental protection -----	22
Warranty -----	23

SAFETY INFORMATION

Please read these instructions fully before operating or maintaining your machine

DESCRIPTION OF SYMBOLS

The following warning symbols appear throughout this manual and indicate the appropriate safety measures you should take when operating and maintaining the Pole Hedge Trimmer.



Read instruction handbook before operating this machine.



Wear ear protection



Wear eye protection



Wear dust mask



Wear head protection



Protective gloves



Protective footwear



Keep bystanders away



Do not expose and operate the tool in rain.



Keep hands away from blade



Keep sufficient distance away from electrical power lines



Li-Ion



Li-Ion

Li-Ion battery. This product has been marked with a symbol relating to 'separate collection' for all battery packs and battery pack. It will then be recycled or dismantled in order to reduce the impact on the environment. Battery packs can be hazardous for the environment and for human health since they contain hazardous substances.

SAFETY INFORMATION

Please read these instructions fully before operating or maintaining your machine



Batteries may enter water cycle if disposed improperly, which can be hazardous for ecosystem. Do not dispose of waste batteries as unsorted municipal waste.



Do not burn



For indoor use only



Read the operator's manual.



Fuse



Positive terminal



Negative terminal



Double insulation



Waste electrical products must not be disposed of with household waste. Please recycle where facilities exist. Check with your local authorities or retailer for recycling advice.

GENERAL SAFETY

! WARNING:

Read all safety warnings and all instructions. Failure to follow the warnings and instructions may result in electric shock, fire and/or serious injury.

Save all warnings and instructions for future reference.

The term “power tool” in the warnings refers to your mains-operated (corded) power tool or battery-operated (cordless) power tool.

- 1) Work area safety**
 - a) Keep work area clean and well lit.** Cluttered or dark areas invite accidents.
 - b) Do not operate power tools in explosive atmospheres, such as in the presence of flammable liquids, gases or dust.** Power tools create sparks which may ignite the dust or fumes.
 - c) Keep children and bystanders away while**

SAFETY INFORMATION

operating a power tool.

Distractions can cause you to lose control.

2) Electrical safety

a) Power tool plugs must match the outlet. Never modify the plug in any way. Do not use any adapter plugs with earthed (grounded) power tools.

Unmodified plugs and matching outlets will reduce risk of electric shock.

b) Avoid body contact with earthed or grounded surfaces, such as pipes, radiators, ranges and refrigerators. There is an increased risk of electric shock if your body is earthed or grounded.

c) Do not expose power tools to rain or wet conditions.

Water entering a power tool will increase the risk of electric shock.

d) Do not abuse the cord. Never use the cord for carrying, pulling or unplugging the power tool. Keep cord away from heat, oil, sharp edges or moving parts. Damaged or entangled cords increase the risk of electric shock.

e) When operating a power tool outdoors, use an extension cord suitable for outdoor use. Use of a cord suitable for outdoor use reduces the risk of electric shock.

f) If operating a power tool in a damp location is unavoidable, use a residual current device (RCD) protected supply. Use of an RCD reduces the risk of electric shock.

3) Personal safety

a) Stay alert, watch what you are doing and use common sense when operating a power tool. Do not use a power tool while you are tired or under the influence of drugs, alcohol or medication. A moment of inattention while operating power tools may result in serious personal injury.

b) Use personal protective equipment. Always wear eye protection. Protective equipment such as dust mask, non-skid safety shoes, hard hat, or hearing protection used for appropriate conditions will reduce personal

SAFETY INFORMATION

injuries.

- c) Prevent unintentional starting. Ensure the switch is in the off-position before connecting to power source and/or battery pack, picking up or carrying the tool.** Carrying power tools with your finger on the switch or energising power tools that have the switch on invites accidents.
- d) Remove any adjusting key or wrench before turning the power tool on.** A wrench or a key left attached to a rotating part of the power tool may result in personal injury.
- e) Do not overreach. Keep proper footing and balance at all times.** This enables better control of the power tool in unexpected situations.
- f) Dress properly. Do not wear loose clothing or jewellery. Keep your hair, clothing and gloves away from moving parts.** Loose clothes, jewellery or long hair can be caught in moving parts.
- g) If devices are provided for the connection of dust extraction and collection facilities, ensure these are connected and properly**

used. Use of dust collection can reduce dust-related hazards.

- 4) Power tool use and care**
 - a) Do not force the power tool. Use the correct power tool for your application.** The correct power tool will do the job better and safer at the rate for which it was designed.
 - b) Do not use the power tool if the switch does not turn it on and off.** Any power tool that cannot be controlled with the switch is dangerous and must be repaired.
 - c) Disconnect the plug from the power source and/or the battery pack from the power tool before making any adjustments, changing accessories, or storing power tools.** Such preventive safety measures reduce the risk of starting the power tool accidentally.
 - d) Store idle power tools out of the reach of children and do not allow persons unfamiliar with the power tool or these instructions to operate the power tool.** Power tools are dangerous in the hands of untrained users.
 - e) Maintain power tools.**

SAFETY INFORMATION

Check for misalignment or binding of moving parts, breakage of parts and any other condition that may affect the power tool's operation. If damaged, have the power tool repaired before use. Many accidents are caused by poorly maintained power tools.

- f) Keep cutting tools sharp and clean. Properly maintained cutting tools with sharp cutting edges are less likely to bind and are easier to control.**
- g) Use the power tool, accessories and tool bits etc. in accordance with these instructions, taking into account the working conditions and the work to be performed.** Use of the power tool for operations different from those intended could result in a hazardous situation.
- 5) Battery tool use and care**
 - a) Recharge only with the charger specified by the manufacturer.** A charger that is suitable for one type of battery pack may create a risk of fire when used with another

battery pack.

- b) Use power tools only with specifically designated battery packs.** Use of any other battery packs may create a risk of injury and fire.
- c) When battery pack is not in use, keep it away from other metal objects, like paper clips, coins, keys, nails, screws or other small metal objects, that can make a connection from one terminal to another.** Shorting the battery terminals together may cause burns or a fire.
- d) Under abusive conditions, liquid may be ejected from the battery; avoid contact.** If contact accidentally occurs, flush with water. If liquid contacts eyes, additionally seek medical help. Liquid ejected from the battery may cause irritation or burns.
- 6) Service**
 - a) Have your power tool serviced by a qualified repair person using only identical replacement parts.** This will ensure that the safety of the power tool is maintained.

SAFETY INFORMATION

ADDITIONAL SAFETY WARNINGS

- 1. Keep all parts of the body away from the cutter blade. Do not remove cut material or hold material to be cut when blades are moving. Make sure the switch is off when clearing jammed material.** A moment of inattention while operating the hedge trimmer may result in serious personal injury.
- 2. Carry the hedge trimmer by the handle with the cutter blade stopped. When transporting or storing the hedge trimmer always fit the cutting device cover.** Proper handling of the hedge trimmer will reduce possible personal injury from the cutter blades.
- 3. Hold the power tool by insulated gripping surfaces only, because the cutter blade may contact hidden wiring.** Cutter blades contacting a “live” wire may make exposed metal parts of the power tool “live” and could give the operator an electric shock.

IMPORTANT READ CAREFULLY BEFORE USE KEEP FOR FUTURE REFERENCE

Safe operating practices

1) Training

Become familiar with the owner's manual before attempting to operate the equipment.

2) Preparation

a) THIS HEDGE TRIMMER CAN CAUSE SERIOUS INJURIES.

Read the instructions carefully for the correct handling, preparation, maintenance, starting and stopping of the hedge trimmer. Become familiar with all controls and the proper use of the hedge trimmer.

b) Never allow children to use the hedge trimmer.

c) Beware of overhead power lines.

d) Avoid operating while people, especially children, are nearby.

e) Dress properly! Do not wear loose clothing or jewellery, which can be caught in moving parts. Use of sturdy gloves, non-skid footwear and safety glasses is recommended.

f) If the cutting mechanism strikes any foreign object or the

SAFETY INFORMATION

hedge trimmer starts making any unusual noise or vibration, shut off the power source and allow the hedge trimmer to stop. Take the following steps:

- inspect for damage;
- check for, and tighten, any loose parts;
- have any damaged parts replaced or repaired with parts having equivalent specifications.

3) Operation

- Remove battery pack before cleaning or when clearing a blockage;
 - checking, carrying out maintenance or working on the hedge trimmer;
 - adjusting the working position of the cutting device;
 - leaving the hedge trimmer unattended;
- Ensure that the hedge trimmer is correctly located in a designated working position before starting the motor.
 - While operating the hedge trimmer, always ensure that the operating position is safe and secure, especially when using steps or a ladder.
 - Do not operate the hedge trimmer with a damaged or excessively worn cutting device.

- Always ensure that all handles and guards are fitted when using the hedge trimmer. Never attempt to use an incomplete hedge trimmer or one fitted with an unauthorized modification.
- Always use two hands to operate a hedge trimmer fitted with two handles.
- Always be aware of your surroundings and stay alert for possible hazards of which you may not be aware due to the noise of the hedge trimmer.

4) Maintenance and storage

- When the hedge trimmer is stopped for servicing, inspection or storage, remove battery pack from the machine and make sure all moving parts have come to a stop. Allow the hedge trimmer to cool before making any inspections, adjustments, etc.
- Always allow the hedge trimmer to cool down before storing.
- When transporting or storing the hedge trimmer, always fit the cutting device transport guard.

SAFETY INFORMATION

SAFETY WARNINGS FOR BATTERY PACK

- a) Do not dismantle, open or shred cells or battery pack.
- b) Do not short-circuit a battery pack. Do not store battery packs haphazardly in a box or drawer where they may short-circuit each other or be short-circuited by conductive materials. When battery pack is not in use, keep it away from other metal objects, like paper clips, coins, keys, nails, screws or other small metal objects, that can make a connection from one terminal to another. Shorting the battery terminals together may cause burns or a fire.
- c) Do not expose battery pack to heat or fire. Avoid storage in direct sunlight.
- d) Do not subject battery pack to mechanical shock.
- e) In the event of battery leaking, do not allow the liquid to come into contact with the skin or eyes. If contact has been made, wash the affected area with copious amounts of water and seek medical advice.
- f) Seek medical advice immediately if a cell or battery pack has been swallowed.
- g) Keep battery pack clean and dry.
- h) Wipe the battery pack terminals with a clean dry cloth if they become dirty.
- i) Battery pack needs to be charged before use. Always refer to this instruction and use the correct charging procedure.
- j) Do not maintain battery pack on charge when not in use.
- k) After extended periods of storage, it may be necessary to charge and discharge the battery pack several times to obtain maximum performance.
- l) Battery pack gives its best performance when it is operated at normal room temperature ($20^{\circ}\text{C} \pm 5^{\circ}\text{C}$).
- m) When disposing of battery packs, keep battery packs of different electrochemical systems separate from each other.
- n) Recharge only with the charger specified by **SPEAR & JACKSON**. Do not

SAFETY INFORMATION

use any charger other than that specifically provided for use with the equipment. A charger that is suitable for one type of battery pack may create a risk of fire when used with another battery pack.

o) Do not use any battery pack which is not designed for use with the equipment.

p) Keep battery pack out of the reach of children.

q) Retain the original product literature for future reference.

r) Remove the battery from the equipment when not in use.

s) Dispose of properly.

GENERAL SAFETY WARNINGS FOR YOUR BATTERY CHARGER

 **WARNING: Read all safety warnings and all instructions.** Failure to follow the warnings and instructions may result in electric shock, fire and/or serious injury.

Save all warnings and instructions for future reference.

This appliance can be used by children aged from 8 years and above and persons with reduced

physical, sensory or mental capabilities or lack of experience and knowledge if they have been given supervision or instruction concerning use of the appliance in a safe way and understand the hazards involved. Children shall not play with the appliance. Cleaning and user maintenance shall not be made by children without supervision.

If the supply cord is damaged, it must be replaced by the manufacturer, its service agent or similarly qualified persons in order to avoid a hazard.

1. Before charging, read the instructions.
2. Do not charge a leaking battery.
3. Do not use chargers for works other than those for which they are designed.
4. Before charging, ensure your charger is matching the local AC supply.
5. For indoor use, or do not expose to rain.
6. The charging device must be protected from moisture.
7. Do not use the charging device in the open.
8. Do not short out the contacts of battery or charger.
9. Respect the polarity “+/-“

SAFETY INFORMATION

- when charging.
10. Do not open the unit and keep out of the reach of children.
 11. Do not charge the batteries of other manufactures or ill-suited models.
 12. Ensure that the connection between the battery charger and battery is correctly positioned and is not obstructed by foreign bodies.
 13. Keep battery charger's slots are free of foreign objects and protect against dirt and humidity. Store in a dry and frost-free place.
 14. When charging batteries, ensure that the battery charger is in a well-ventilated area and away from inflammable materials. Batteries can get hot during charging. Do not overcharge any batteries. Ensure that batteries and chargers are not left unsupervised during charging.
 15. Do not recharge non-rechargeable batteries, as they can overheat and break.
 16. Longer life and better performance can be obtained if the battery pack is charged when the air temperature is

- between 18°C and 24°C. Do not charge the battery pack in air temperatures below 4.5°C, or above 40.5°C. This is important as it can prevent serious damage to the battery pack.
17. Charge only battery pack of the same model provided by SPEAR & JACKSON and of models recommended by SPEAR & JACKSON.

BOX CONTENT

PARTS

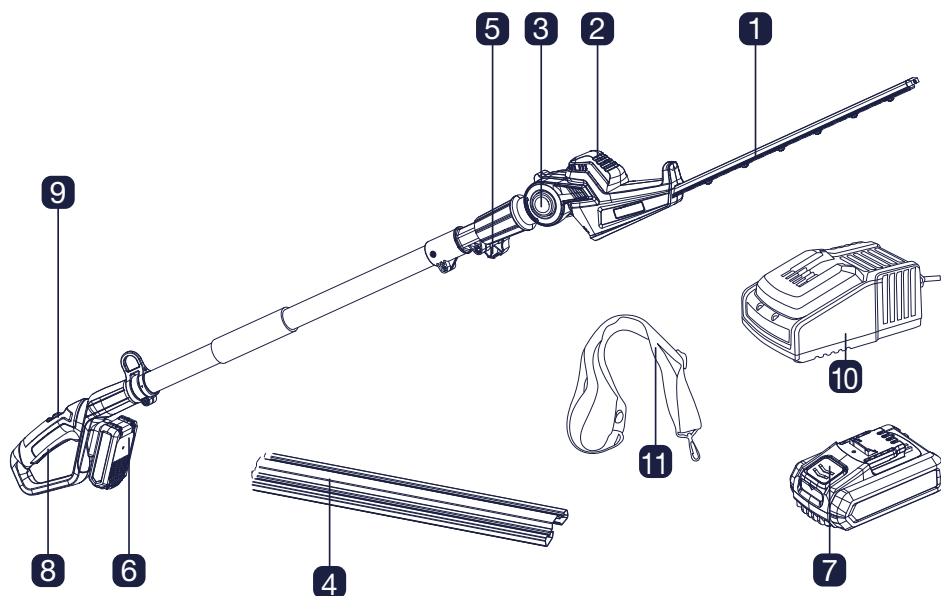

- 1 Blade
- 2 Motor housing
- 3 Lock button
- 4 Blade sheath
- 5 Clamp knob
- 6 Battery pack
- 7 Battery pack release button
- 8 On/off switch
- 9 Lock-off switch
- 10 Battery charger
- 11 Shoulder belt



If there are any parts missing, please call the customer helpline on 0345 605 2069

ASSEMBLE

Preparing To Assemble The Pole Hedge Trimmer

-  Always take care when removing the packaging to prevent damage to you or to the pole hedge trimmer.
-  **IMPORTANT!** Before assembling the pole hedge trimmer, check all the parts indicated in the manual are in the box. Inspect all the parts for signs of damage. Do not assemble the pole hedge trimmer if you observe any damaged components.
-  **NOTE:** Before using the tool, read the instruction book carefully. Remove all parts of the pole hedge trimmer from the box and carefully remove all packaging. Take care not to lose any instructions which may be attached to the tool, these provide important information which will be required while assembling the pole hedge trimmer.

- 1** **TO ASSEMBLE THE POLE (See Fig. A1-A4)**
Loosen the clamp knob (5) by turning anti-clockwise. Extend the pole to expose the two small cylinders (b). Turn the clamp knob (5) in a clockwise direction to lock the pole to avoid movement while assembling.

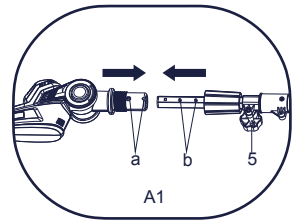

- 2** Align and insert the extended pole into the machine head (See Fig. A2).

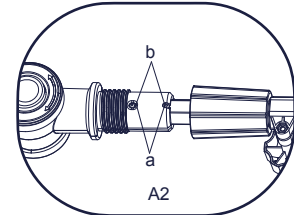

- 3** Tighten the sleeve (e) securely by turning clockwise. (See Fig. A3, A4).
NOTE: Make sure that the sleeve is firmly tightened in place.

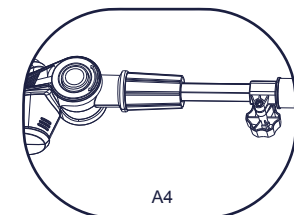
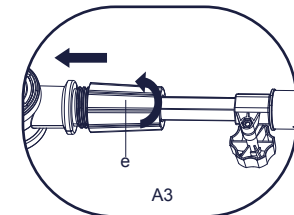

ASSEMBLE

TO ASSEMBLE THE SHOULDER BELT (See Fig B)

Your pole hedge trimmer is supplied with a shoulder belt. The shoulder belt is supplied with a quick release hook. Connect the hook to the bracket of machine body located before the handle.

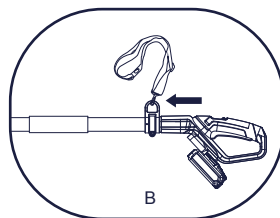

PREPARE

BEFORE PUT INTO OPERATION

1 CHARGING THE BATTERY PACK (See Fig. C1, C2, C3)

WARNING! The charger and battery pack are specially designed to work together so do not attempt to use any other devices. Never insert or allow metallic objects into your charger or battery pack connections because of an electrical failure and hazard will occur.

NOTE:

- a) Do not use any charger other than that specifically provided for use with the equipment.
- b) If the battery pack is very hot you must remove your battery pack from the charger and allow time for the battery to cool down before recharging.
- c) The battery in your new tool is not charged when it leaves the plant. Therefore it must be full charged before using the first time.
- d) Please charge the battery to reach full or no less than half charge before storage. If the tool will not be used for long periods of time, charge the battery every 3-6 months.

CHARGING PROCEDURE





Connect the battery charger to the power supply, the green light will turn on. Slide the battery pack into the charger to make the connections (See Fig. C1). The green light will turn off, at the same time, the red light will turn on to show charging has started. When charging is completed, the red light will turn off and the green light will turn on. After fully charged, unplug the charger and remove the battery pack for using. (See Fig. C2)

NOTE:

If the battery pack is locked in the charger, press the battery pack release button and remove it.

WARNING! When battery charge runs out after continuous use or exposure to direct sunlight or heat, allow time for the battery to cool down before re-charging to achieve the full charge.

CHARGING INDICATOR

Light	ON/OFF flash	Status
Red on ● 	—————	Charging
Red flash 	- - - - -	Defective Battery
Green on ● 	—————	Fully Charged
Green flash 	- - - - -	Battery Hot/Cold Delay

2 INSTALL OR REMOVE BATTERY PACK (See Fig.D1, D2)

After recharging, insert the battery pack into trimmer's battery port (Fig.D1). A simple push and slight pressure will be sufficient. Depress the battery pack release button to release battery pack from your trimmer (Fig.D2).

NOTE: When removing the battery pack, hold it firmly to avoid potential accidents.

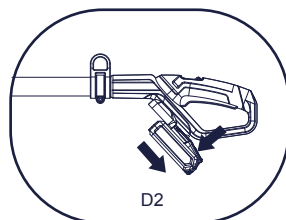
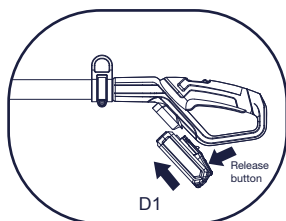
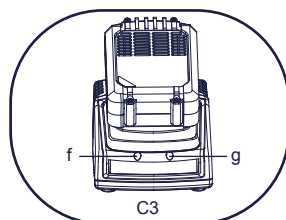
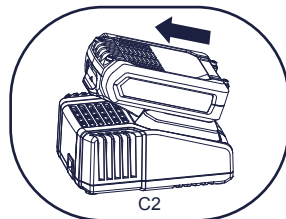
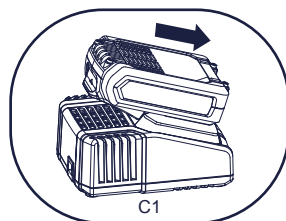

OPERATION

BEFORE STARTING YOUR POLE HEDGE TRIMMER

Remove the blade sheath as shown in Fig. E.

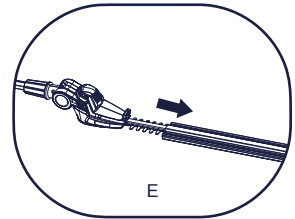

START OR STOP YOUR HEDGE TRIMMER (See Fig F)

Your trimmer is equipped with a lock-off switch.

Push the Lock-off button backwards; at the same time, press the on/off switch to start your trimmer.

Release the on/off switch to stop your trimmer.

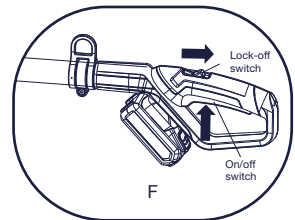

ADJUSTING THE POLE LENGTH (See Fig G)

To extend the pole, loosen the clamp knob (5) by turning anti-clockwise. Then the pole will slide freely.

To lock the pole to the required length, tighten the clamp knob (5) by turning clockwise.

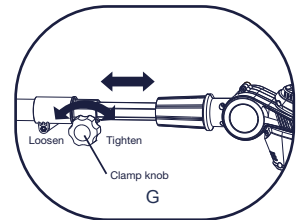

ADJUSTING THE MACHINE HEAD TO THE REQUIRED ANGLE (See Fig H)

Push the lock button of the machine head and then rotate the machine head to the desired position.

Release the lock button again and check whether the button is locked in place. (See Fig. H)

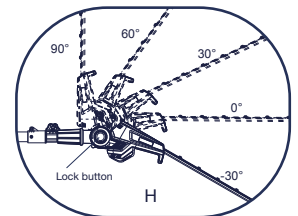

NOTE: The Machine head can be locked on 5 positions. (-30°, 0°, 30°, 60°, 90°) (See Fig. H)

OPERATION

OPERATING THE POLE HEDGE TRIMMER (See Fig I1, I2, I3)

Always hold the trimmer with both hands and with the blade away from you before turning it on.

When trimming new growth, use a wide sweeping action so that the stems are fed directly into the blade.

Allow the cutting blades to reach full speed before cutting. When operating, keep the cutting blades away from people and objects such as walls, large stones, trees, vehicles, etc.

If the blade jam, immediately stop the trimmer. Release the switch before attempting to clear jammed things from the cutting blades.

Do not attempt to cut stems that are too thick for the cutting blade.

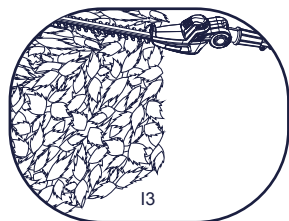
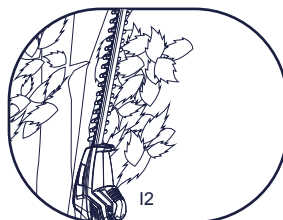
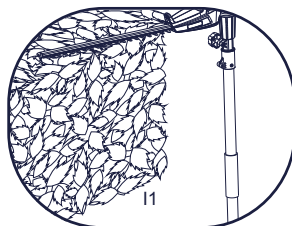

MAINTENANCE



WARNING!

Always remove the plug from the electrical socket before clean or repair.

- 1) Never use water to clean the unit.
- 2) Always clean the pole hedge trimmer immediately after use. Brush the blade using a stiff nylon brush to remove any debris.
- 3) Always store the unit in a dry place.
- 4) Inspect the hedge trimmer before each use.
- 5) Have the unit professionally repaired if any damage occurs.
- 6) The blade rail should be cleaned and treated with fine lubricating oil after each use.
- 7) Use the blade guard for transportation and storage.

TECHNICAL DATA

Pole hedge trimmer	S18EHP
Rated voltage	18V ---
No load speed	2800 /min
Cutting width	16 mm
Cutting length	450 mm
Telescopic tube range	85-125cm
Machine weight	3.5kg

Charger	ACG18G25
Charger input	100-240V~50/60Hz 70W
Charger output	20V --- 2.5A
Charging time	1 hr

Battery pack	ABP118W2
Battery type	Lithium-Ion
Battery capacity	18V --- 2.0Ah, 36Wh

Accessories	
Blade sheath	1
Battery charger	1
Battery pack	1
Shoulder strap	1

TECHNICAL DATA

Noise Information

A weighted sound pressure	$L_{pA}=74.5\text{dB(A)}$ $K_{pA}=3.0\text{dB(A)}$
A weighted sound power	$L_{wA}=83.04\text{dB(A)}$ $K_{wA}=3.0\text{dB(A)}$
Wear ear protection.	

Vibration total values (triax vector sum) determined according to EN 60745:

Vibration emission value: $a_{T1}=2.2\text{m/s}^2$ Uncertainty $K=1.5\text{m/s}^2$

The declared vibration total value may be used for comparing one tool with another, and may also be used in a preliminary assessment of exposure.

⚠ WARNING: The vibration emission value during actual use of the power tool can differ from the declared value depending on the ways in which the tool is used dependant on the following examples and other variations on how the tool is used:

How the tool is used and the materials being cut or drilled.

The tool being in good condition and well maintained

To use the correct accessory for the tool and ensuring it is sharp and in good condition.

The tightness of the grip on the handles and if any anti vibration accessories are used.

And the tool is being used as intended by its design and these instructions.

This tool may cause hand-arm vibration syndrome if its use is not adequately managed.

⚠ WARNING: To be accurate, an estimation of exposure level in the actual conditions of use should also take account of all parts of the operating cycle such as the times when the tool is switched off and when it is running idle but not actually doing the job. This may significantly reduce the exposure level over the total working period.

Helping to minimise your vibration exposure risk.

ALWAYS use sharp chisels, drills and blades

Maintain this tool in accordance with these instructions and keep well lubricated (where appropriate)

If the tool is to be used regularly then invest in anti vibration accessories.

Plan your work schedule to spread any high vibration tool use across a number of days.

TROUBLESHOOTING

The following chart lists problem symptoms, possible causes and corrective action, if your pole hedge trimmer does not operate properly. If these do not identify and correct the problem, contact your service agent.

⚠ WARNING: Always switch the product off, disconnect it from power supply and let the product cool down before performing inspection, maintenance and cleaning work!

Problem	Possible cause	Solution
Pole hedge trimmer does not operate	Battery discharged	Recharge battery; also see “Charging The Battery Pack”
	Battery not fully connected	Ensure the battery pack release button is fully locked
	Machine head not assembled well with the pole	Check to see if the machine head and the pole are assembled in place. Follow step 2 in TO ASSEMBLE THE POLE.
Pole hedge trimmer operates intermittently	Internal wiring damaged	Contact Helpline 0345 605 2069
	On/Off switch defective	
Motor runs but blades remain stationary	Internal fault	Contact Helpline 0345 605 2069
Cutting blade hot	Cutting blade dull	Have blade sharpened
	Cutting blade is damaged	Have blade inspected/overhauled
	Too much friction, due to lack of lubricant	Apply lubricant spray
Cutting time per battery charge too low	Too much friction, due to lack of lubricant	Apply lubricant spray
	Blade needs cleaning	Clean blade
	Battery not fully charged	Recharge battery; also see “Charging The Battery”
The blades are running slow	Battery discharged	Recharge battery; also see “Charging The Battery”
	Battery stored outside of battery temperature	Allow battery to warm naturally to room temperature (within battery operating temperature 10–45 °C)
Battery charge indicator(a) does not light up	Mains plug of battery charger not plugged in (properly)	Insert mains plug (fully) into the socket outlet
	Socket outlet, mains cable or battery charger defective	Contact Service Agent

ENVIRONMENTAL PROTECTION



Waste electrical products should not be disposed of with household waste. Please recycle where facilities exist. Check with your Local Authority or retailer for recycling advice.

WARRANTY

If your device develops a fault, please don't hesitate to contact our customer service department on 0345 605 2069, we can solve 80% of problems via the phone.

1. These warranty terms cover additional warranty rights and do not affect your statutory warranty rights. All our products are covered by a 3 year manufacturer warranty.
2. Claims must be accompanied by proof of purchase. This must be in the form of a sales receipt or bank statement and must show that the product has been purchased within the warranty period as described under point 1, from the retailer that it was originally bought from. Please keep your receipt safe or staple it to the back of this manual for future reference.
3. Our warranty covers problems caused by material or manufacturing defects, and will result in the repair of these defects or replacement of the device with a like for like or similar article.
4. Our devices have not been designed for commercial, trade or industrial applications, any signs of use of the equipment in these application or equivalent activities, invalidates the warranty.
5. The following are also excluded from our warranty:
 - 1) Faults due to accidents, customer misuse or unauthorized repairs
 - 2) Consumable Parts such as cutting line, plant protectors, handles, knobs, extension cable and other accessories that are compatible with the product.
 - 3) Failure due to lack of routine maintenance.
 - 4) Failure as a result of not using the equipment in accordance with the manual and safety instructions
 - 5) The adjustment of cables, battery pack, chargers or switches.

Warranty claims should be submitted before the end of the warranty period, see point 1, but a paid service exists for repairs commissioned after this period. The original warranty period remains applicable to the device even if repairs are carried out or parts are replaced.

In such cases, the work performed or parts fitted will not result in an extension of the warranty period, and no new warranty will become active for the work performed or parts fitted.

If you have any problems or questions concerning your garden power tool, please contact our after sales service at 0345 605 2069.

This device may be re-conditioned, like for like or upgraded replacement.

