

# Hisense

life reimagined

## **USER'S OPERATION MANUAL**

Before operating this unit, please read this manual thoroughly, and retain for future reference.

**WD3S1043BW3**  
**WD3S1043BB3**

EN

English

This washer dryer is intended solely for household use.  
Please do not use it for any laundry labelled as not suitable for machine washing.

The following symbols are used throughout the manual and they have the following meanings:

 Information, advice, tip, or recommendation

 Warning – general danger

 Warning – danger of electric shock

 Warning – danger of hot surface

 Warning – danger of fire



It is important that you carefully read the instructions.

# CONTENTS

<b>4 SAFETY PRECAUTIONS</b>	<b>INTRODUCTION</b>
<b>12 WASHER DRYER DESCRIPTION</b> 13 Technical specifications	
<b>14 INSTALLATION AND CONNECTION</b> 15 Removing the blocking screws / rods 16 Moving and transport after installation 17 Selecting the room 17 Adjusting the washer dryer feet 18 Washer dryer installation clearances 19 Connecting to water supply 19 Aqua stop 20 Connecting and securing the water discharge hose 22 Connecting the appliance to the power mains	<b>PREPARING THE WASHER DRYER BEFORE FIRST USE</b>
<b>23 BEFORE USING THE APPLIANCE FOR THE FIRST TIME</b>	
<b>24 WASHING PROCESS, STEP BY STEP (1-6)</b> 24 Step 1: Heed the labels on the laundry 26 Step 2: Preparing the washing process 29 Step 3: Choosing the washing programme 33 Step 4: Selecting additional settings and functions 39 Step 5: Starting the washing programme 40 Step 6: End of the washing programme	<b>STEPS OF THE WASHING PROCESS</b>
<b>41 INTERRUPTIONS AND CHANGING THE PROGRAMME</b>	
<b>43 MAINTENANCE &amp; CLEANING</b> 43 Cleaning the detergent compartment 44 Cleaning the water supply hose, detergent dispenser housing, and rubber door gasket 45 Cleaning the pump filter 46 Cleaning the washer dryer exterior	<b>WASHER DRYER CLEANING AND MAINTENANCE</b>
<b>47 TROUBLESHOOTING</b> 47 What to do ...? 48 Troubleshooting and error table 49 Servicing	
<b>50 RECOMMENDATIONS FOR WASHING AND ECONOMIC USE YOUR WASHER DRYER</b> 51 Stain removal tips <b>53 DISPOSAL</b> <b>54 TYPICAL CONSUMPTION TABLE</b> <b>55 Wi-Fi connection</b>	<b>MISCELLANEOUS</b>

# SAFETY PRECAUTIONS



**Carefully read the instructions for use before using the washer dryer.**

**Please, do not use the washer dryer without reading and understanding these instructions or use first.**

**These instructions for use of a washer dryer are supplied with different types or models of washer dryer. Therefore, they may include descriptions of settings or equipment that are not available in your washer dryer.**

Failure to observe the instructions for use or inappropriate use of the washer dryer may result in damage to the laundry or the appliance, or injury to the user. Keep the instruction manual handy, near the washer dryer.

**This appliance is intended to be used in household.**

If the washer dryer is used for professional, for-profit purpose or purpose exceeding normal use in a household, or if the washer dryer is used by a person who is not a consumer, the warranty period shall be equal to the shortest warranty period required by relevant legislation.

Follow the instructions for correct installation of the washer dryer and connection to the water and power mains (see chapter »INSTALLATION AND CONNECTION«).

Connection to water and power supply has to be executed by an adequately trained technician or expert.



Any repair and maintenance pertaining to safety or performance should be done by trained experts.

To avoid danger, **a damaged power** cord may only be replaced by the manufacturer, a service technician, or an authorized person.

**Before connecting the washer dryer to the power mains, wait for at least 2 hours until it reaches room temperature.**

**This product must be serviced by an authorized Service Center, only use approved spare parts by authorized manufacturers.**

**Under no circumstances should you attempt to repair the appliance yourself. Repairs carried out by inexperienced persons may cause injury or more serious malfunctioning. Refer to your local Service Center, and always insist on genuine spare parts.**

In case of incorrect washer dryer connection, incorrect use, or servicing by an unauthorized person, the user shall bear the cost of any damage as such damage shall not be covered by warranty.

The washer dryer may not be connected to the power mains using an extension cord.

Do not connect the washer dryer to power mains using an external switching device such as a programme timer, or connect it to power mains that is regularly switched on and off by the power supply provider.

Do not connect the washer dryer to an electrical outlet intended for an electric shaver or hair dryer.

The power socket has to be safely earthed, and the water supply should be unimpeded.

**Do not install the washer dryer in a room where the temperature can drop to below 5°C**, as washer dryer parts may be damaged in case of water freezing.

Place the washer dryer on a level and stable solid (concrete) base.

If the washer dryer is placed on an elevated stable base, the washer dryer has to be additionally secured against tipping.

**Before the first use of the washer dryer, remove the transport screws**, as switching on a blocked washer dryer can result in serious damage (see chapter »INSTALLATION AND CONNECTION/Removing the transport screws«). Warranty shall be void in cases of such damage.

**To connect the washer dryer to water supply**, make sure to use the supplied water supply hose and gaskets. Water pressure has to be between 0.1–1 MPa (1-10 bar; 1–10 kp/cm<sup>2</sup>; 10–100 N/cm<sup>2</sup>).

Always use a new water supply hose to connect the washer dryer to water supply; do not reuse an old water supply hose.

The end of the water discharge hose should reach into a water drain line.

Before the start of the washing cycle, press the door on the indicated spot until it locks into place. The door cannot be opened during washing machine operation.

**We recommend removing any impurities from the washer dryer drum before the first wash** using the Drum clean programme (see PROGRAMME TABLE).

**After the washing cycle, close the water tap and pull out the washer dryer plug from the power socket.**

Only use agents for washer dryer and care of laundry. We shall not be responsible for any damages or discolouration of gaskets and plastic parts resulting from incorrect use of bleaching or colouring agents.

**When descaling**, only use descaling agents with added anti-corrosion protection. (Only use non-corrosive descaling agents.) Follow the manufacturer's instructions. Finish the descaling process with several rinse cycles or by running the Drum clean (Self-cleaning programme) in order to remove any residual acid (e.g. vinegar etc.).

 Do not use detergents that contain solvents as this could lead to release of poisonous gases, damage to the washer dryer, and risk of fire and explosion.

No silver ions are released during the washing programme.

The washer dryer is not intended for use by persons (including children) with physical or mental impairments, or persons with lacking experience and knowledge. These persons should be instructed about the use of the washer dryer by a person responsible for their safety.

**The warranty does not cover** consumables, minor deviations in colour, increased noise that results from appliance age and which does not affect the functionality of the appliance, and aesthetic defects on components, which do not affect the functionality and safety of the appliance.

## **CHILD SAFETY**

Before closing the washer dryer door and running the programme, make sure there is nothing except laundry in the drum (e.g. if a child climbed into the washer dryer drum and closed the door from the inside).

Keep the detergent and conditioner out of reach of children.

**Activate the child lock.** See chapter »SELECTING ADDITIONAL SETTINGS AND FUNCTIONS/CHILD LOCK«.

**Do not let children younger than three years come near the appliance, unless they are under constant supervision.**

**The washer dryer is made in compliance with all relevant safety standards.**

This washer dryer may be used by children aged 8 years and above and by persons with reduced physical,

sensory or mental capabilities or lack of experience and knowledge, but only if they are supervised during the use of the washer dryer, if they have been provided relevant instructions regarding safe use of the washer dryer, and if they understand the hazards of inappropriate use. Make sure children do not play with the appliance. Children may not clean the washer dryer or perform any maintenance tasks without supervision.

### **DANGER OF HOT SURFACE**

At higher washing temperatures, the door glass will heat up. Be careful to avoid burns. Make sure children do not play near the door glass.

### **WATER OVERFLOW PROTECTION (WITH WASHER DRYER SWITCHED ON)**

If the water level in the appliance rises above normal level, then the excess water level protection will be activated. It will shut off the water supply and start pumping out the water. The program is interrupted and an error is reported (see TROUBLESHOOTING TABLE).

### **TRANSPORT/TRANSPORT AFTER INSTALLATION**

If you intend to move the washer dryer after it has been installed, then it should be blocked by inserting the transport screws (see chapter »INSTALLATION AND CONNECTION/Moving and transport«). Before inserting the transport screws, disconnect the washer dryer from the power mains!

If the supply cord is damaged, it must be replaced by the manufacturer, its service agent or similarly qualified persons in order to avoid a hazard.

Water drained during a high-temperature wash or drying cycle is hot. Do not touch the water.

Do not open the washer dryer door by force while it is operating (high-temperature washing/drying/spinning).

That the tumble dryer is not to be used if industrial chemicals have been used for cleaning.

That lint must not be allowed to accumulate around the tumble dryer.

That adequate ventilation has to be provided to avoid the back flow of gases into the room from appliances burning other fuels, including open fires.

Do not dry unwashed items in the tumble dryer.

Items that have been soiled with substances such as cooking oil, acetone, alcohol, petrol, kerosene, spot removers, turpentine waxes and wax removers should be washed in hot water with an extra amount of detergent before being dried in the tumble dryer.

Items such as foam rubber (latex foam), shower caps, waterproof textiles, rubber backed articles and clothes or pillows fitted with foam rubber pads should not be dried in the tumble dryer.

Fabric softeners, or similar products, should be used as specified by the fabric softener instructions.

Remove all objects from pockets such as lighters and matches.

**WARNING:** Never stop a tumble dryer before the end of the drying cycle unless all items are quickly removed and spread out so that the heat is dissipated.

**WARNING:** The appliance must not be supplied through an external switching device, such as a timer, or connected to a circuit that is regularly switched on and off by a utility. For appliances with ventilation openings in the base, a carpet must not obstruct the openings.

The appliance must not be installed behind a lockable door, a sliding door or a door with a hinge on the opposite side to that of the tumble dryer, in such a way that a full opening of the tumble dryer door is restricted.

Exhaust air must not be discharged into a flue that is used for exhausting fumes from appliances burning gas or other fuels.

# WASHER DRYER DESCRIPTION

## FRONT

- 1 Control unit
- 2 Programme selector knob
- 3 Detergent compartment
- 4 Door
- 5 Rating plate
- 6 Pump filter cover

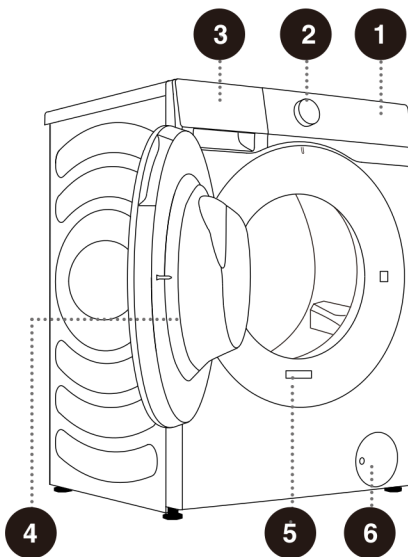

## BACK

- 1 Water supply hose
- 2 Power cord
- 3 Water discharge hose
- 4 Adjustable feet
- 5 Blocking rods/screws

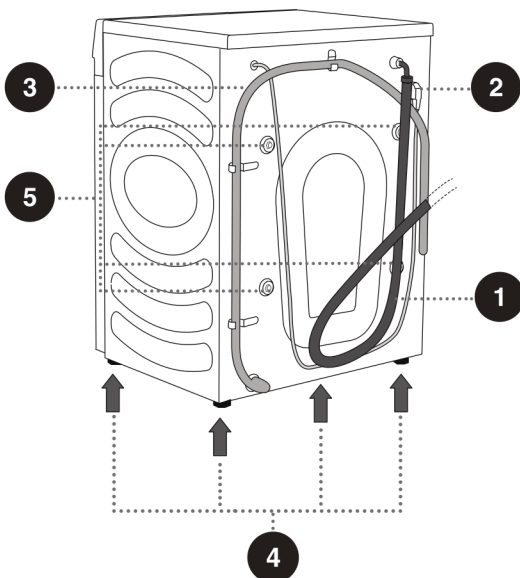

💡 The illustrations in this manual are for reference purpose only. As our products are subject to continual improvement, the appearance, color and functional parts of your actual product may vary from the illustrations.



# TECHNICAL SPECIFICATIONS

## (DEPENDING ON THE MODEL)

Rating plate with basic information about the washer dryer is fitted on the front wall of the washer dryer door opening (see chapter »WASHER DRYER DESCRIPTION«).

<b>Washing/drying Capacity</b>	10.5kg/6kg
<b>Washer dryer weight</b>	72kg
<b>Rated Voltage</b>	220-240V~
<b>Rated power</b>	1750W/1350W
<b>Frequency</b>	50Hz

## Dimensions(mm)

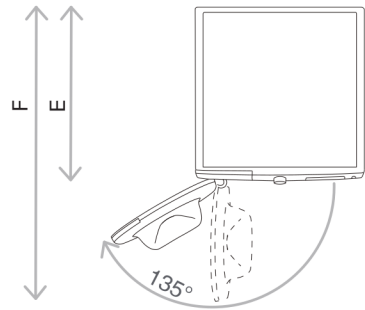
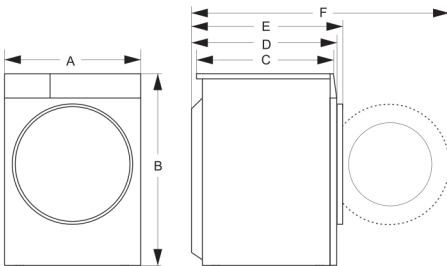

Index	Dimension(mm)
A	595
B	845
C	560
D	590
E	620
F	1100



E = Washer dryer depth  
F = Depth with door open

Rating plate

**Hisense** Washer-dryer  
XXXXXXXXXXXX  
XXX-XXXV~ XXHz IPX4  
Washing Capacity:XX kg (XXXXW)  
Drying Capacity:X kg (XXXXW)

**⚠ Before connecting the washer dryer to the power mains, wait for at least 2 hours until it reaches room temperature.**

# INSTALLATION AND CONNECTION

⚠ Remove all packaging. When removing the packaging, make sure not to damage the appliance with a sharp object. Keep the packaging material (plastic bags, other plastic parts etc.) out of reach of children.

Check for any damage on the appliance. If you suspect the appliance is damaged, do not use it and immediately contact the service unit.

The appliance is supplied with a support set that includes:

- Instructions for use;
- 4 plastic plugs;
- Supply hose;
- Drain hose holder;
- Wrench;
- Noise reduction board.

Make sure all of the above is supplied.

## HOW TO INSTALL THE NOISE REDUCTION BOARD

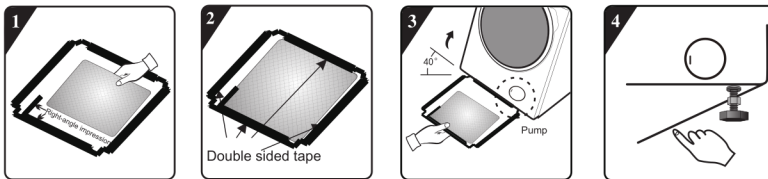

**1** Before installing the noise reduction board align and paste the acoustic absorption wool with and along the right-angle impression on noise reduction board (this procedure is unnecessary for some of the models without acoustic absorption wool).

**2** Remove surface paper on double sided tape at four sides of the noise reduction board.

**3** Incline the machine to an angle of 40° and let the side with right-angle notch face towards front of the washer dryer, as shown in the figure. Insert the side with oblique-angle notch between two foot screws at back of the washer dryer completely in place. Then, install the noise reduction board and ensure that it contacts with bottom of the washer dryer closely.

**4** Press the double sided tape on four sides manually to secure the noise reduction board to the machine body firmly.

# REMOVING THE BLOCKING SCREWS/RODS

⚠ Before the first use of the appliance, transport screws/rods must be removed. A blocked appliance may be damaged when it is switched on for the first time. Warranty shall be void in cases of such damage.

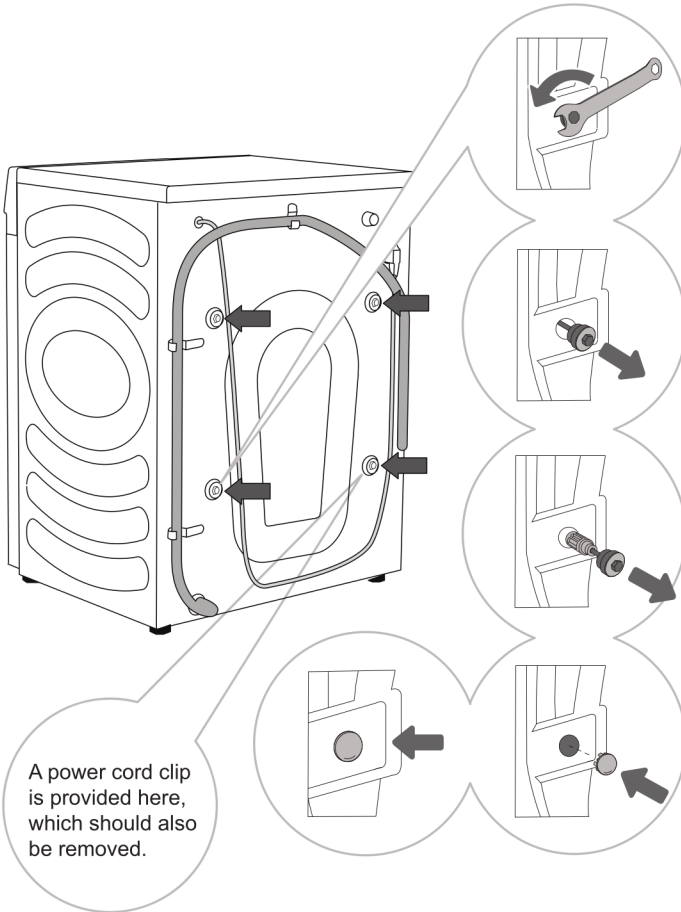

**1** Move aside the hoses and use a fitting spanner to undo the 4 screws on the back of the appliance by turning them counter clockwise, as indicated by the arrow. Undo them by approximately 30 mm (not completely).

**2** Pull all 4 transport screws/rods horizontally.

**3** Pull out the transport screws/rods complete with the rubber and the plastic part.

**4** Cover the four holes through which the blocking screws/rods were inserted with plastic plugs. The plastic plugs are supplied in the bag with the washing machine instruction manual (the support set).

💡 Save the transport screws/rods in case you have to transport the appliance again later (to reinstall the blocking screws/rods, follow the above procedure in reverse order).

## MOVING AND TRANSPORT AFTER INSTALLATION

⚠ If you wish to move the washer dryer after it has been installed, the blocking screws/rods have to be re-installed to prevent vibration damage to the washer dryer during transport (see chapter» INSTALLATION AND CONNECTION/Removing the transport screws/rods«). If you lost the blocking screws/rods, they can be ordered from the manufacturer.

**⚠ After transport, the washer dryer should be left to stand still for at least two hours before it is connected to the power mains, so that it can reach room temperature. The appliance should be installed and connected by a trained technician.**

**⚠ Carefully read the instructions for use before connecting the washer dryer. Repair or any warranty claim resulting from incorrect connection or use of the washer dryer shall not be covered by the warranty.**

# SELECTING THE ROOM

☞ Floor on which the washer dryer is placed must have a concrete base. It should be clean and dry; otherwise, the washer dryer may slide. Also, clean the bottom surface of adjustable feet.

☞ The washer dryer must stand level and stable on a solid base.

# ADJUSTING THE WASHER DRYER FEET

Use a spirit level and the supplied spanner.

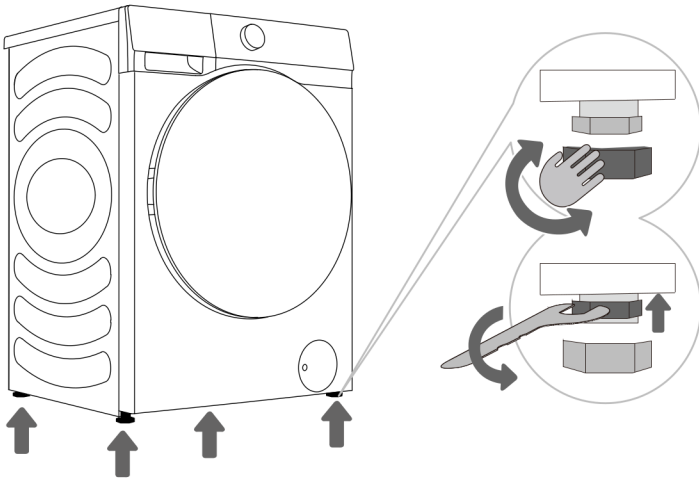

.....  
**1** Rotate the adjustable feet to level the washer dryer lengthwise and crosswise. The feet allow levelling by +/- 2 cm.  
.....

**2** After adjusting the height of the feet, firmly tighten the jam nuts (counter nuts) using the supplied spanner by turning them towards the bottom of the washer dryer ↑ (see figure).

☞ Incorrect levelling of the washer dryer with the adjustable legs may cause vibration, appliance sliding across the room, and loud operation. Incorrect levelling of the washer dryer is not subject to warranty.

☞ Sometimes, unusual or louder noise may appear during appliance operation; these are mostly the result of improper installation.

## WASHER DRYER INSTALLATION CLEARANCES

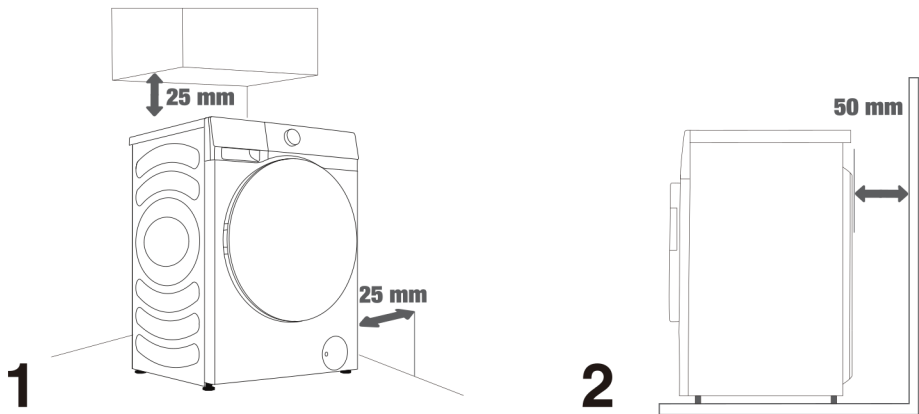

⚠ The washer dryer may not be in contact with a wall or adjacent furniture. For optimum washer dryer operation, we recommend observing the clearances from the walls as indicated in the figure.

In case of failure to observe the minimum required clearances, safe and correct washer dryer operation cannot be ensured. Moreover, overheating can also occur (figures 1 and 2).

⚠ Installing the washer dryer under a countertop is not recommended.

# CONNECTING TO WATER SUPPLY

Attach the hose to the water tap by screwing it onto the thread.

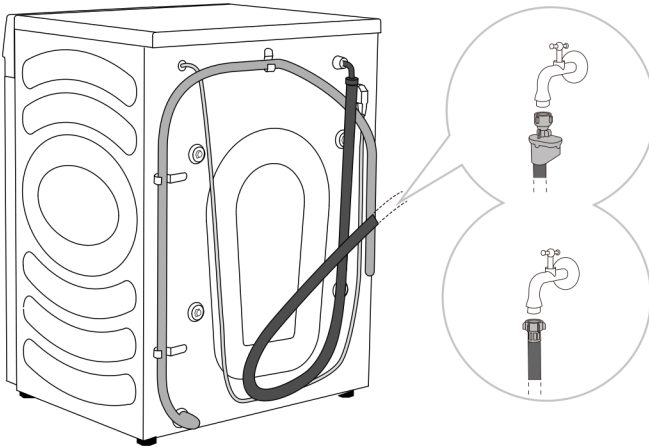

**A** AQUA STOP

**B** REGULAR CONNECTION

☞ For normal washer dryer operation, the pressure in the water mains should be between 0.1–1 MPa (1–10 bar; 1–10 kp/cm<sup>2</sup>; 10–100 N/cm<sup>2</sup>). Minimum dynamic water pressure can be determined by measuring the water flow. In 15 seconds, 3 litres of water should flow from a fully open tap.

☞ Tighten the water supply hose by hand, firmly enough for the hose to have a good seal (max. 2 Nm). After connecting the hose, the seal must be checked for any leaks. Do not use pliers or similar tools when connecting the hose as this could damage the nut thread.

☞ Only use the water supply hose supplied with the appliance. Do not use any used or other hoses.

☞ Make sure the hose is not damaged. If the hose is degraded, brittle, or cracked, it has to be replaced.

## AQUA STOP (ONLY WITH SOME MODELS)

If an internal tube or hose is damaged, a shut-off system is activated that cuts the water supply to the washer dryer. In such case, the control glass (a) will turn red. Replace the water supply hose.

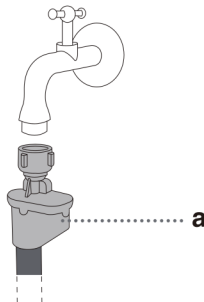

- ⚠ Do not dip the water supply hose with the Aqua stop system in water as it contains an electric valve.
- ⚠ The water supply hose can be connected without a non-return valve.
- ⚠ When connecting the water supply hose, make sure to connect it in a way that allows adequate and unobstructed water supply.

## CONNECTING AND SECURING THE WATER DISCHARGE HOSE

Feed the water discharge hose into a washbasin or a bathtub, or connect it directly to a drain (discharge hose minimum diameter 4 cm). The vertical distance from the floor to the end of the discharge hose may be no more than 100 cm and no less than 60 cm. It can be attached in three ways (A, B, C).

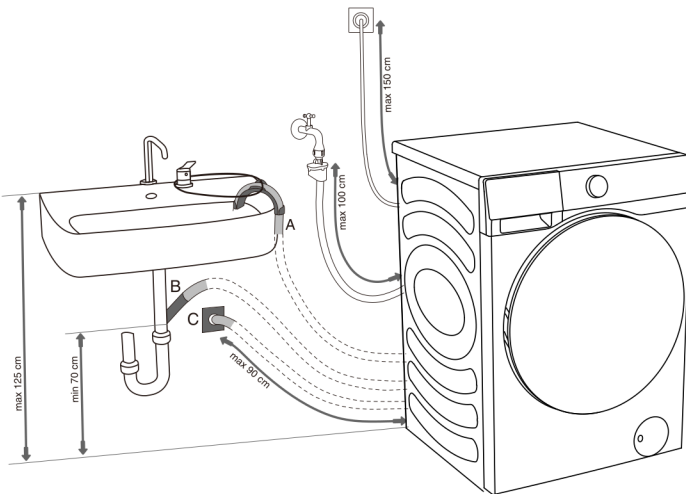

**A** Discharge hose end may be placed over a sink or a bathtub. B Use a string fed through the opening in the elbow support to attach the hose and prevent it from slipping to the floor.

**B** Discharge hose may also be attached directly to the sink drain. A sink that is too small is not acceptable. Be careful as the drained water may be hot.



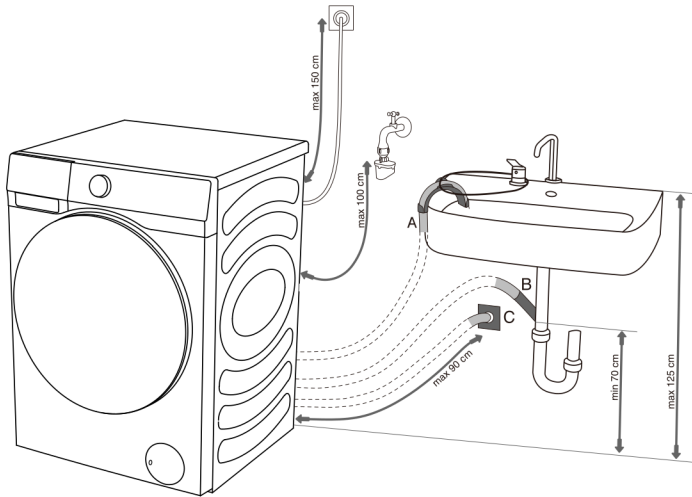

**C** Discharge hose can also be attached to a wall drain with a trap; such trap should be properly installed to allow cleaning.

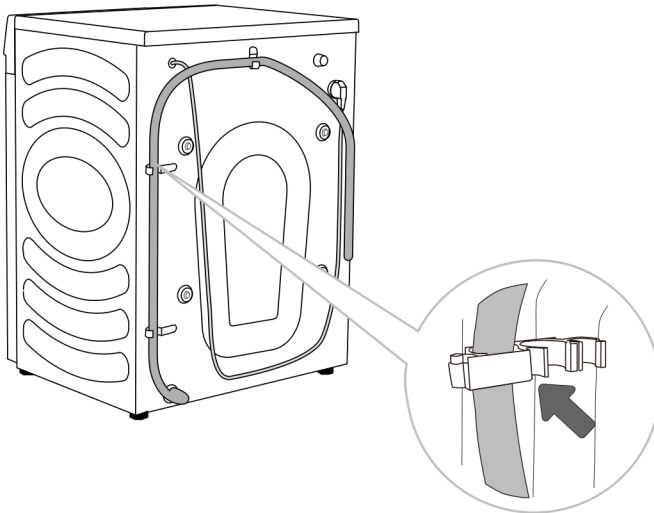

**D** The discharge hose has to be attached and affixed to the pin on the back of the washer dryer, as shown in the figure.

⚠ Make sure the drain hose is not damaged.

⚠ If the discharge hose is not correctly attached, safe and correct washer dryer operation cannot be ensured.

# CONNECTING THE APPLIANCE TO THE POWER MAINS

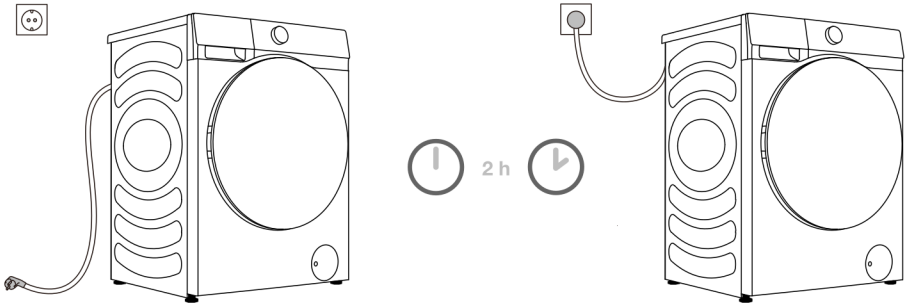

**⚠ Before connecting the washer dryer to the power mains, wait for at least 2 hours until it reaches room temperature.**

Connect the washer dryer to a grounded power outlet. After installation, the wall outlet should be freely accessible. The outlet should be fitted with an earth contact (in compliance with the relevant regulations).

Information on your washer dryer is indicated on the rating plate.

**⚠ We recommend using over-voltage protection to protect the appliance in case of a lightning strike.**

**⚠ The washer dryer may not be connected to the power mains using an extension cord.**

⚡ Do not connect the washer dryer to an electrical outlet intended for an electric shaver or hair dryer.

⚡ Do not plug or unplug the appliance when your hands are wet.

⚡ Any repair and maintenance pertaining to safety or performance should be done by trained experts.

⚡ A damaged power cord may only be replaced by a person authorized by the manufacturer.

# BEFORE USING THE APPLIANCE FOR THE FIRST TIME

Make sure the washer dryer is disconnected from the power mains; then, open the door towards you (figures 1 and 2).



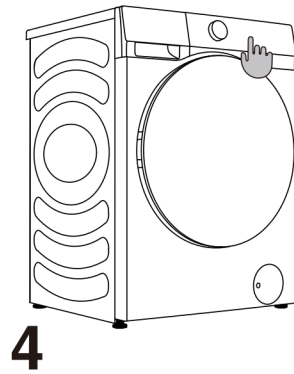
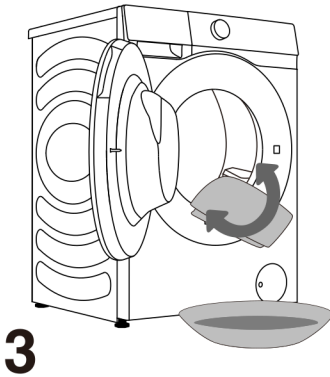
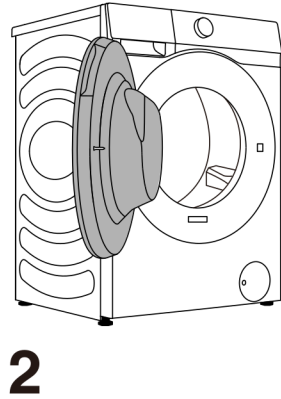
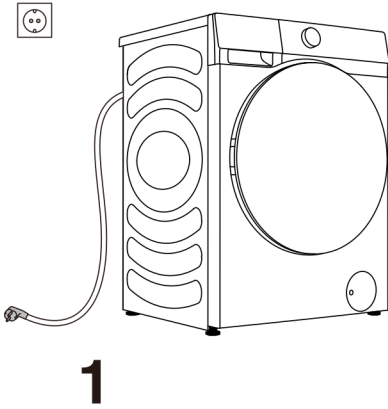























Before using the appliance for the first time, clean the drum using a soft and moist cotton cloth, or use the drum clean program. In such case, connect the appliance to the power mains and open the water tap. There should not be any laundry in the drum; the drum should be empty (Figures 3 and 4).



**⚠** Do not use any solvents or cleaning agents that could damage the washer dryer (please observe the recommendations and warnings provided by the cleaning agent manufacturers).





# WASHING PROCESS, STEP BY STEP (1–6)

## STEP 1: HEED THE LABELS ON THE LAUNDRY







<b>Normal wash; Sensitive laundry</b>	Max. washing temp. 95°C  	Max. washing temp. 60°C  	Max. washing temp. 40°C  	Max. washing temp. 30°C  	Hand wash only 	Do not wash 
<b>Bleaching</b>	Bleaching in cool water 			Bleaching not allowed 		
<b>Dry cleaning</b>	Dry cleaning with all agents 	Petroleum solvent R11, R113 	Dry cleaning in kerosene, pure alcohol, and R113 	Dry cleaning not allowed 		
<b>Ironing</b>	Hot ironing, max. 200°C 	Hot ironing, max. 150°C 	Hot ironing, max. 110°C 	Ironing not allowed 		
<b>Drying</b>	Dry flat (place on a flat surface) 	Drip dry  Line dry 	High temperature  Low temperature 	Do not tumble dry 		

# NON WASHABLE • DRY/NON-DRY CLOTHES

Clothes that can neither be washed nor dried

 <p>Leather and fur products (Deformation may be caused)</p>	 <p>Rayon and its blended products (Discoloration or deformation may be caused)</p>	 <p>Large thick rubber cushions with carbamate on the back (Damage or fault may be caused)</p>
 <p>Hats with hard material (It will damage the washing machine and cause faults)</p>	 <p>Cushions, pillows, articles with cotton wadding, foam and other sponge materials, carpet cover (Damage or fault may be caused)</p>	<p>Others: Wrinkled or embossed clothes; crepe fabrics; Easily deformed clothes (suits, jackets, ties and dresses, etc.); Easily fluffing clothes (velvet, velveteen).</p>

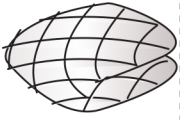
# NON-DRY CLOTHES

 <p>Any of clothes marked by graphic (Clothes may be damaged)</p>	 <p>Woolen clothes (Shrinkage and fur loss may be caused)</p>	 <p>Tights, stockings (Damage or deformation may be caused)</p>	 <p>Sizing clothes</p>
 <p>Cushions or clothes with furs (Damage or fault may be caused)</p>	 <p>Quilt (Damage or fault may be caused)</p>	 <p>Clothes with lace and embroidery, new synthetic fiber (very fine fiber) (Deformation may be caused)</p>	 <p>Silk</p>

If it is used to dry cushions and clothes with furs, it may lead to drain pipe blockage.

## Note

- ⚠ Non washable-dry/non-dry clothes include but not limited to the above clothes.
- ⚠ The wet clothes still dripping are not suitable for drying, which may cause the machine to alarm!

## STEP 2: PREPARING THE WASHING PROCESS

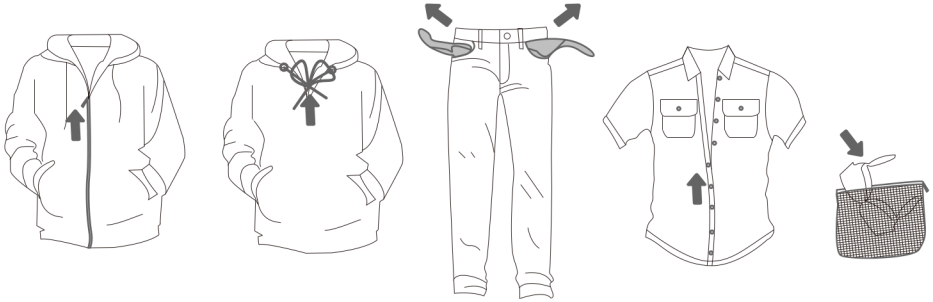

1. Sort the laundry by type of fabric, colour, soiling, appliance load, and allowed washing temperature (see PROGRAMME TABLE).
2. Close the buttons and zippers, tie any ribbons, and turn the pockets inside out; remove any metal clips that could damage the laundry and washer dryer interior, or clog the drain.
3. Place very sensitive clothes and small items in a special-purpose laundry washing bag.

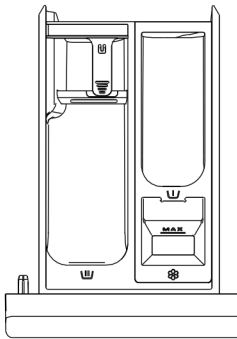

## ► ADDING OF DETERGENT/SOFTENER



### Symbols of detergent dispenser compartments

	prewash
	main wash
	softener

☼ We recommend adding powder detergent immediately before the washing cycle. If you add it sooner, make sure the detergent compartment in the dispenser tray is completely dry before adding the powder detergent: otherwise, the powder detergent may cake before the start of the washing process.

☼ Pour the softener into the detergent compartment, into the compartment with the symbol . Observe the recommendation on the softener packaging.

☼ Do not fill the softener compartment over the Max indicated level. Otherwise, the softener will be added to the laundry too soon, leading to poorer washing effect.

Keep detergents and additives out of reach of children.

# SWITCHING ON THE WASHER DRYER

Use the power cord to connect the washer dryer to power mains, and connect the washer dryer to water supply.

Turn the appliance on by press the button "POWER" (figures 1 and 2).

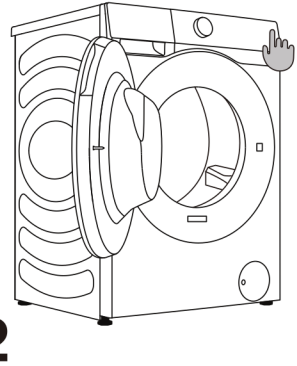
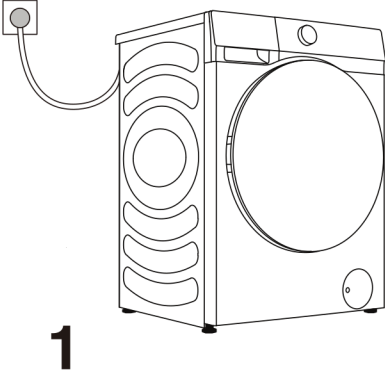

# LOADING THE WASHER DRYER

Open the washer dryer door by pulling the handle towards you (figure 1).

Insert the laundry into the drum (after making sure the drum is empty) (figure 2).

Close the washer dryer door (figure 3). The door is closed when you here a click.

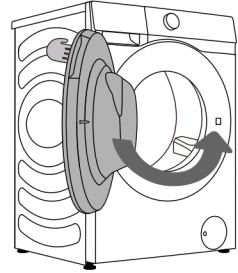
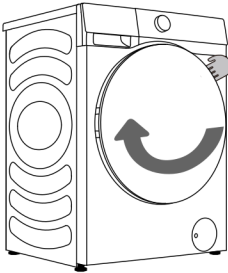

⚠ Never try to forcefully open the door. Moreover, do not open the door during washer dryer operation.

Do not overload the drum! See PROGRAMME TABLE and observe your nominal load as indicated on the rating plate.

If the washer dryer drum is too full, the laundry will not be washed as thoroughly.

# CONTROL UNIT

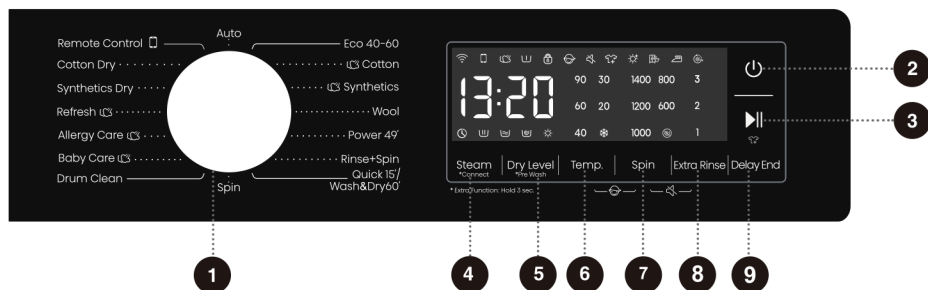

## 1 CYCLE SELECTOR

Turn the dial to select a cycle.

## 2 POWER

Press to turn on/off the washer dryer.

## 3 START/PAUSE

Start/Pause the whole machine program running.

## 4 STEAM

\*CONNECT  
Add or subtract Steam function by short press. Washer dryer network control by long press.

## 5 DRY LEVEL

\*PRE WASH  
Select the dry time and additional functions of dry by short press. Add pre wash function by long press.

## 6 TEMP.

Press to change the water temperature for the selected cycle.

## 7 SPIN

Press to change the spinning speed for the current cycle. NO Spin: The drum does not spin after the final drain cycle.

## 8 EXTRA RINSE

Press to change the rinse count for current cycle.

## 9 DELAY END

Delay End lets you set the end time of the current cycle.

## 6+7 CHILD LOCK

Press these two keys at the same time to enable or disable the Child Lock function.

## 7+8 MUTE

Press these two keys at the same time to switch off or restore the acoustic signals.

For extra function: Press and hold for 3 seconds.



# STEP 3: CHOOSING THE WASHING PROGRAMME

Choose the **programme** by rotating the programme selector knob (1) to the left or to the right (depending on the type of laundry and how heavily soiled it is). **See programme table.**

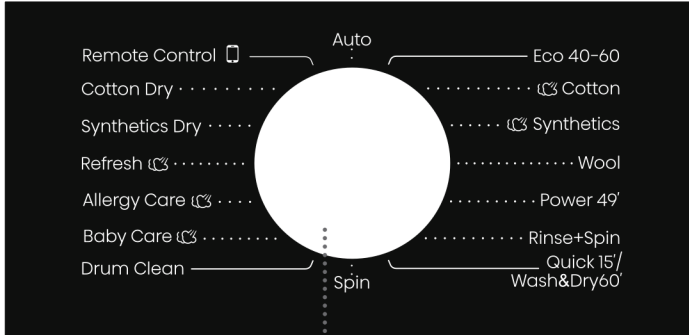

1

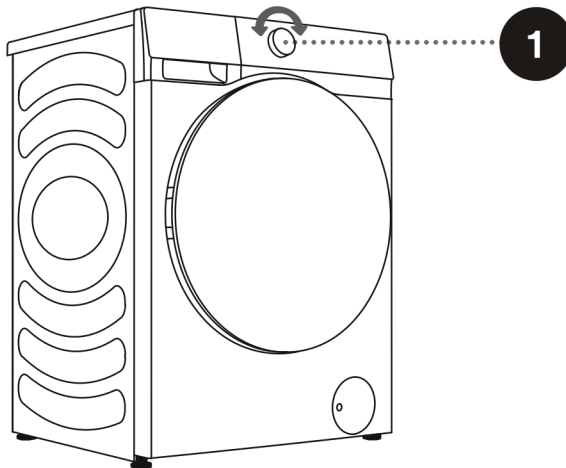

During operation, the programme selector knob will not rotate automatically.

# PROGRAMME TABLE

Programme	Functions	Max. load	Max spinning rate (rpm)	Programme description
<b>Eco 40-60</b> —	W	10.5kg	1400	Normally soiled cotton laundry.
	WD	6kg		
<b>Cotton</b> (☼, 20°C, 30°C, 40°C, 60°C, 90°C)	W	10.5kg	1400	Heavily and moderately soiled cotton, or linen. For very heavily soiled items select the "Prewash" function.
	WD	6kg		
<b>Synthetics</b> (☼, 20°C, 30°C, 40°C, 60°C)	W	5kg	1400	The program is suitable for moderately soiled synthetic and cotton fabrics.
	WD	5kg		
<b>Wool</b> (☼, 20°C, 30°C, 40°C)	W	2kg	600	The program is suitable for machine washable wool.
<b>Power 49'</b> (☼, 20°C, 30°C, 40°C)	W	4kg	1400	It is a short-time powerful washing procedure, which is used to wash a small amount of clothes with a high degree of dirt.
	WD	4kg		
<b>Rinse+Spin</b> —	W	10.5kg	1400	This program is defaulted to two rinses and spin.
	WD	6kg		
<b>Quick 15'</b> (☼, 20°C, 30°C, 40°C)	W	1kg	800	Cotton, mixed fabrics. Items worn for a short time or newly bought.
<b>Wash&amp;Dry 60'</b> —	WD	1kg	1400	The wash and dry process within 60 minutes, is suitable for wash and dry the clothing with light dirty at once, such as the T-shirts, shirts and skirts that should be changed daily. It is recommended that no more than 3 pieces of skirts should be washed at a time. Select the function key "Dry Level" to complete the conversion of the Quick 15' and Wash&Dry 60' programs.
<b>Spin</b> —	S	10.5kg	1400	In this program, you can select the duration and spinning rate manually.
	SD	6kg		
<b>Drum Clean</b> (90°C)	WD	0kg	800	The program is used for cleaning the drum and removing any residues of detergent and bacteria that can accumulate and develop especially when you use programmes with low washing temperatures. The drum has to be empty. You can add some distilled (spirit) vinegar (approx. 2 dl) or sodium bicarbonate (1 tablespoon, or 15 g). Run this programme at least once a month.
<b>Baby Care</b> (40°C, 60°C, 90°C)	W	2kg	1400	It is suitable for baby clothes and underwear, etc., which sterilizes and disinfects through high temperature steam.
	WD	2kg		

W→Wash

D→Dry

WD→Wash and Dry

S→Spin

SD→Spin and Dry

Programme	Functions	Max. load	Max spinning rate (rpm)	Programme description
<b>Allergy Care</b> (60°C)	W	2kg	1400	It is suitable for high temperature resistant and less fading fabrics, which removes allergens such as pollens, mites and parasites through high temperature steam.
	WD	2kg		
<b>Refresh</b> —	D	2kg	-	It is suitable for removing the peculiar smell (such as, the smell of smoke/hot pot/barbecue, etc.) on the clothes.
<b>Synthetics Dry</b> —	D	5kg	-	The wet chemical fiber clothes can be dried after being spun.
<b>Cotton Dry</b> —	D	6kg	-	The wet cotton & linen clothes can be dried after being spun.
<b>Auto</b> (☼, 20°C, 30°C, 40°C)	W	6kg	1400	The program will automatically adjust the main washing duration and rinsing times according to the amount of clothes in the washer dryer. It is applicable for lightly soiled clothes.
	WD	6kg		
<b>Remote Control</b> 	-	-	-	

W→Wash

D→Dry

WD→Wash and Dry

S→Spin

SD→Spin and Dry

#### NOTE:

- 1) Water Temperature: Select the appropriate water temperature for chosen wash programme. Always follow garment manufacturer's care label or instructions when washing to avoid damage to clothes.
- 2) Actual water temperature may differ from the declared cycle temperature.
- 3) The washing effect depend on water pressure, water hardness, water inlet temperature, room temperature, type and amount of load, degree of soiling utilized detergent, fluctuations in the main electricity supply and chosen additional options.
- 4) Natural (non sudsing) detergent is recommended.
- 5) If you add a considerable amount of laundry during the wash, the laundry could be washed less effectively, since the washer dryer initially sensed a lower weight of the load of laundry and added a smaller amount of water. Insufficient amount of water relative to the amount of laundry could also cause damage to the laundry (rubbing of dry laundry), and washing time can be longer.

 Maximum amount of laundry for washing, in kg (for the cotton programme), is indicated on the rating plate fitted under the appliance door.

 Maximum or nominal load applies to laundry prepared pursuant to the IEC 60456 standard.

 For better washing effect, we recommend loading the drum to 2/3 when using the cotton programmes.

# CHOOSING THE DETERGENTS AND ADDITIVES

Always choose highly efficient detergents that do not foam and which are intended for front-loading appliances.

The choice of detergent depends on the type, soil level, laundry colour, and washing temperature.

☹ White residues (streaks etc.) on black laundry may appear if you are using modern phosphate-free detergents. In such case, brush the streaks and use a liquid detergent.

Only use detergent intended for appliances for household use.

Descaling agents may damage the appliance. Do not wash the clothes that were cleaned with solvents or flammable substances.

Observe the manufacturer's instructions on detergent dosing.

Excessive amount of detergent may result in foaming that in turn impairs washing efficiency. If the appliance senses excessive foaming, it may prevent the spin cycle from taking place. If the amount of detergent is too small, the laundry may no longer be white after a while. It could also result in accumulation of limescale in the drum and the pipes.

## STEP 4: SELECTING ADDITIONAL SETTINGS AND FUNCTIONS

Most programmes feature basic settings, but these settings can be changed.

Adjust the settings by pressing the relevant function button (before pressing the START/PAUSE button).

☞ Activate/deactivate the functions by pressing the desired function (before pressing the START/PAUSE button).

☞ Certain settings cannot be selected with some programmes. Such settings will not be lit, and when the corresponding button is pressed, an acoustic signal will be emitted and the button will flash (see FUNCTION TABLE).

The additional settings and functions can only be set in the standby mode of the applicable program, that is, before the program starts running, and cannot be selected after the program runs.

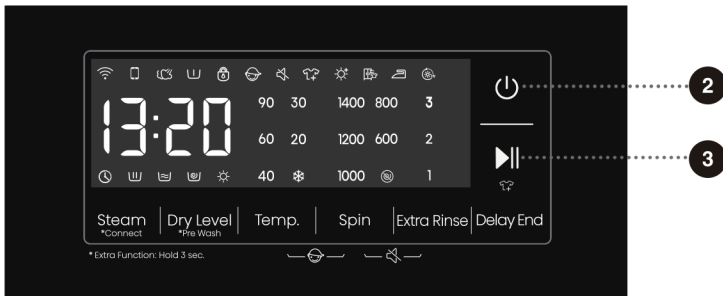

### 2 Power

For powering on/off the washer dryer.

When the washer dryer is in standby, or after the screen displays the program end interface, press and hold the Power key to enter the power-off state.

In standby mode, or in the program end interface or Wash retry reminder interface, if no operation is performed within 10min, the washer dryer will shut down automatically.

In power-off state, all displays and outputs will be off, and remote startup is not supported.

### 3 Start/Pause

For starting a program, or suspending a running program.

If the machine door isn't closed or the door lock is not engaged, the washer dryer will not start, and an alarm will be displayed on the screen.

After a program is started, or when the pause state is selected, the set functions and parameters cannot be changed. Press and hold the Power button to turn off the machine, and then restart it to reset the parameter.

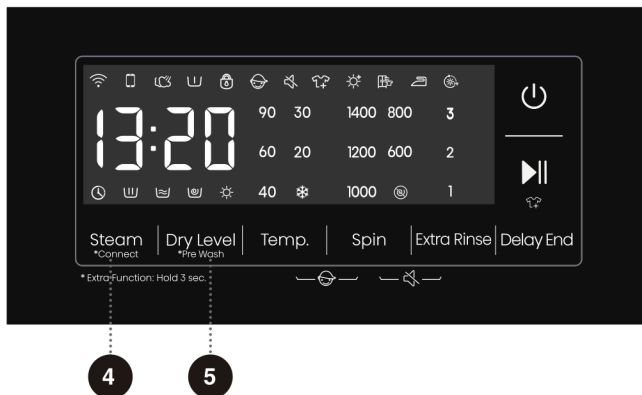

#### 4 Steam

Press briefly: Add "Steam" function, press twice to cancel the function, and cycle in sequence.

Programs with the steam icon " " can use the steam function. The Allergy Care and Baby Care programs come with the steam function by default and it cannot be deactivated. When the steam function is chosen, the corresponding steam icon will light up.

#### \*Connect

Press and hold: Connect the Wi-Fi of the washer dryer, the control panel symbol " " flashes, and then conduct the networking operation. See the networking description for the specific networking method.

#### 5 Dry Level

Short press the "Dry Level" button to select the dry time and additional functions of dry. After selecting the corresponding function, the corresponding icon will light up.

The washer dryer can sense the weight of clothes to adjust the dry time automatically except for the function of Time Dry. Before drying, please confirm whether the clothes can be dried. If the clothes with different materials are dried together, the dry effect may be affected. So it is recommended to classify the clothes before drying.

Before starting to dry, make sure that the tap is open and the cold water is in place. If the hand-washing clothes requires for drying, before drying, please select the spin with high speed as possible according to the clothes types.

At the end of dry, the washer dryer will run for a period of time according to a certain rhythm to loosen the clothes and reduce the wrinkle. The wall attachment of excessive and dehydrated cotton clothes may affect the dry effect, please take the dehydrated clothes out from the drum, and put it into the drum after making it loose.

Short press this button to cycle between Extra Dry, Cupboard, Iron and Time Dry.

[Extra Dry] function owns the effect that the clothes can be stored up after being dried.

[Cupboard] function owns the effect that the clothes can be worn instantly after being dried.

[Iron] function owns the effect that the clothes with little water can be ironed after being dried.

[Time Dry] function refers to dry the clothes for a specified time.

Users press the "Dry Level" button to select any type of dry time with 6 types, including 30 minutes, 1 hour, 1.5 hours, 2 hours, 3 hours, and 4 hours. Please select a reasonable dry time.

Otherwise, the clothes will not be dried fully if the dry time is too short.

Note: The wet clothes still dripping are not suitable for drying, which may cause the machine to alarm!

## \*Pre Wash

Press and hold: Increase the "Pre Wash" function, long press twice to cancel the function, and cycle in sequence.

Select this function to add a Pre Wash program before the Main Wash stage.

When this function is selected, the pre-wash function indicator "" is always on from the beginning to the end of the program.

When selecting the Pre Wash function, please add detergent to the prewash compartment of the detergent dispenser.

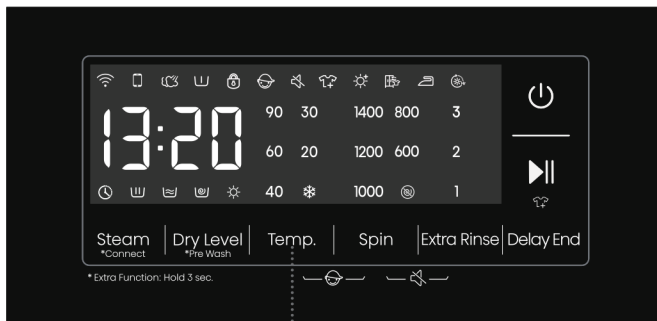

6

## 6 Temp.

Changing the temperature for the selected program.

Each program has a preset temperature that can be changed by pressing the position TEMP. (\* indicates cold wash).

The temperature is displayed on the display unit above the button.

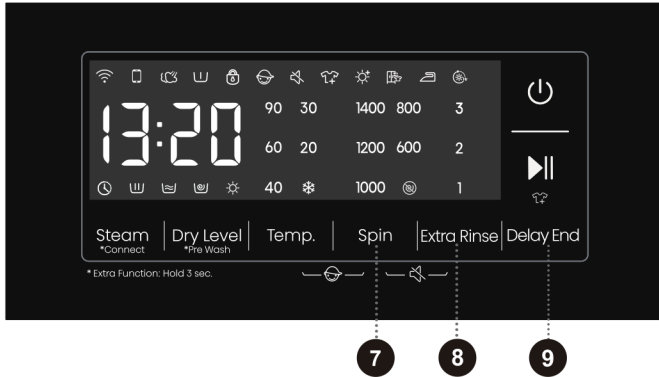

## 7 Spin

Use this to adjust the spinning rate. With preset or selected spinning rate, the selected spinning rate will be lit on the display unit. If you select draining without spinning, the "🕒" will appear on the display unit.

## 8 Extra Rinse

In the standby state, after Extra Rinse is selected, the number of Extra Rinse is shown, which may be used a maximum of three times. In addition, the default rinsing times plus the number of Extra Rinse cannot exceed five times. After the program is started, the indicator is always on.

## 9 Delay End 🕒

Use this feature to schedule washing at a convenient time. Press this key to set the Delay End time. This key is only valid in standby mode. After the Delay End function is selected, each time the Delay End key is pressed, the time increases by 1h. The maximum selectable time range is 24 hours.

The Delay End time is the end time, that is, it includes the washing time, so the Delay End time must be greater than the washing time. Based on your settings, the start time of the cycle will be determined by the machine's internal logic. Press to choose a preset unit of hours.

When the Delay End function is being selected (set), the Clock icon "🕒" is always on; When the Delay End programme is running, the Clock icon "🕒" flashes.

If the Delay End function was chosen before starting a program, it can be canceled by pressing any other function key. Once the program has started, you need to press and hold the Power button to turn off and restart the machine to cancel the Delay End function.



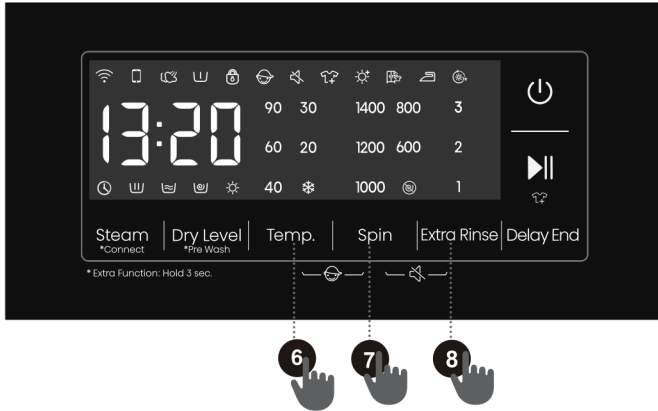

## 6 + 7 Child Lock

This is a safety feature. To activate it, simultaneously press the positions Temp. and Spin, and hold them for at least 2 seconds, Child Lock icon will light up, and then Child Lock is set up. Repeat the same operation, the Child Lock will be released.

When the Child Lock is set, all function buttons will be shielded except the Power button.

After completing program, child lock will automatically unlock.

## 7 + 8 Mute

Use this to switch off or restore the acoustic signals.

When the machine is in the state of holding, pause or operation, press "Spin +Extra Rinse" buttons for 2 seconds, The display will show mute function icon. All the buzzing will be turned off except the alarms.

When the machine is in the mute state, press "Spin+Extra Rinse" buttons for 2 seconds until mute function icon light off. All the buzzing will be activated.

# FUNCTION TABLE

Programme	Detergent Compartment			Mute	Child Lock	Delay End	Extra rinse	Spin	Temp.	Dry Level	Prewash	Steam
	Prewash	Main wash	Softener									
Eco40-60	-	•	•	•	•	•	-	•	-	•	-	-
Cotton	•	•	•	•	•	•	•	•	•	•	•	•
Synthetics	•	•	•	•	•	•	•	•	•	•	•	•
Wool	-	•	•	•	•	•	•	•	•	-	-	-
Power 49'	•	•	•	•	•	•	•	•	•	•	•	-
Rinse+Spin	-	-	•	•	•	•	•	•	-	•	-	-
Quick 15'	-	•	•	•	•	•	•	•	•	-	-	-
Wash&Dry 60'	-	•	•	•	•	•	-	-	-	•	-	-
Spin	-	-	-	•	•	•	-	•	-	•	-	-
Drum Clean	-	-	-	•	•	•	-	-	-	•	-	-
Baby Care	•	•	•	•	•	•	•	•	•	•	•	•
Allergy Care	•	•	•	•	•	•	•	•	-	•	•	•
Refresh	-	-	-	•	•	•	-	-	-	•	-	•
Synthetics Dry	-	-	-	•	•	•	-	-	-	•	-	-
Cotton Dry	-	-	-	•	•	•	-	-	-	•	-	-
Auto	•	•	•	•	•	•	•	•	•	•	•	-

- Optional functions
- Can not be selected

## TIME OPTIMIZATION DURING THE PROGRAMME PROGRESS

In the early stage of the washing programme, the washer dryer uses advanced technology to detect the amount of laundry. After load detection, the washer dryer adjusts the programme duration.

### STEP 5: STARTING THE WASHING PROGRAMME

Once you have selected the programme and extra functions, and added the detergent into the detergent compartment, press the **START/PAUSE** button.

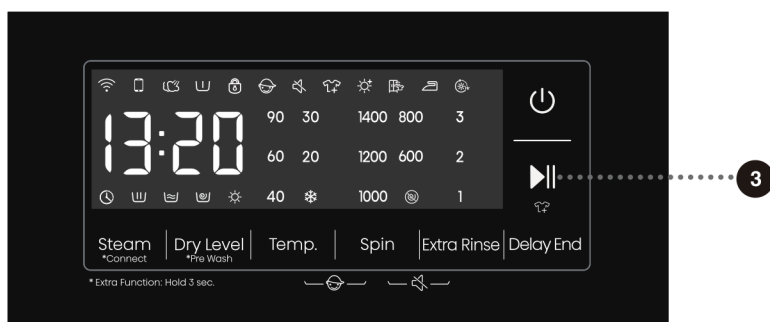

After pressing the **START/PAUSE** button, child lock can be activated or deactivated, and sound signal can be set; other settings, however, cannot be changed.

When the program starts, "----" will appear on the display unit, which indicates that the laundry is being weighed. Program duration (hours : minutes) will be adjusted automatically according to the laundry weight.

After the start of the programme, Door Lock "🔒" will be lit on the display unit. When the program is complete, the icon will disappear.

If you press the **START/PAUSE** button during program operation, and all conditions are met for you to open the door, then the "🔒" will disappear as well.

If the "🔒" flashes, this means that the door cannot be opened; in such case, do not attempt to open the door by force.

🔔 If anything is flashing on the display unit, the washer dryer door is open or not closed correctly. Close the washer dryer door and press the **START/PAUSE** button again to resume the washing programme.

## STEP 6: END OF THE WASHING PROGRAMME

An acoustic signal will indicate the end of the washing process; the display will read »End«. The appliance will switch off automatically if you do not perform any action within 2 minutes.



1. Open the washer dryer door.
2. Take the laundry from the drum.
3. Close the door!
4. Shut off the water supply tap.
5. Unplug the power cord from the outlet.

# INTERRUPTIONS AND CHANGING THE PROGRAMME

## CHANGE OF WASHING PROGRAMME

To stop and cancel a washing programme, press the button "POWER" for 2 seconds.

To select a new programme, choose the programme by rotating the knob and select extra functions. Press the start/pause button, without adding the detergent again.

## MANUAL INTERRUPTION

To stop and cancel a washing programme, press the button "POWER" for 2 seconds.

## PAUSE BUTTON

The washing programme can always be stopped by pressing the **START/PAUSE** button. The washing programme is **temporarily paused** when the time remaining until programme completion is flashing on the display unit. If there is no water in the drum and water temperature is not too high, then the door will unlock, and they can be opened. To resume the washing program, first close the door and then press the key **START/PAUSE** button.

## ADDING/REMOVING LAUNDRY DURING WASHER DRYER OPERATION

During a pause, the time on the display will blink. If the "Add Clothes" icon  lights up, it indicates that the door can be opened. The door lock will automatically release, allowing you to add clothes. If the "Add Clothes" icon isn't lit, pressing pause won't unlock the door, and it cannot be opened.

After adding clothes midway, press start/pause button and the washing program will resume running.

 If you add a considerable amount of laundry during the wash, the laundry could be washed less effectively, since the washer dryer initially sensed a lower weight of the load of laundry and added a smaller amount of water. Insufficient amount of water relative to the amount of laundry could also cause damage to the laundry (rubbing of dry laundry), and washing time can be longer.

 Washing time will resume from the point at which the washing programme was interrupted.

 When the program is suspended in spin state and then restarted, it will run again from the initial state of spin.

## ERRORS

In case of an error or fault, the programme will be interrupted.

Flashing signal lights and an acoustic signal will warn about such occurrence (see TROUBLESHOOTING TABLE), and the error will be indicated on the display (F:XX).

## POWER SUPPLY FAILURE

In case of a power supply failure (power outage), the washing programme is interrupted. When power supply is restored, the program is resumed in the stage in which it was interrupted.

# EMERGENCY DOOR OPENING

**⚠ If there is still water in the washer dryer after a power outage, make sure not to open the door before you manually drain the water from the washer dryer via the pump filter.**

In case of failure to open the door due to power outage or other special circumstances, the door lock lever at the drainage pump door can be used for emergency opening.

Note:

1. Do not operate when the machine is working normally;
2. Before operation, please make sure that the inner barrel has stopped turning, without high temperature, and the water level is lower than the clothing inlet. If the water level is higher than the clothing inlet, drain off water through the drain-away pipe (if available) or by slowly unscrewing the filter.
3. Operation method: Open the cover of drainage pump door, remove the screws, pull down the lock lever with the help of a tool, and then the door can be opened(indicated in the figure).

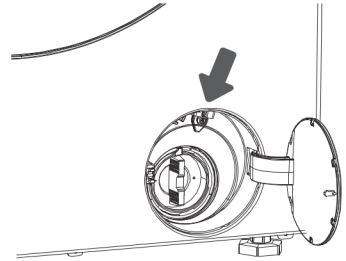

# MAINTENANCE & CLEANING

 Before cleaning, unplug the washer dryer from the power mains.

 Children should not clean the washer dryer or perform maintenance tasks without proper supervision!

## CLEANING THE DETERGENT COMPARTMENT

 Detergent compartment should be cleaned at least twice per month.

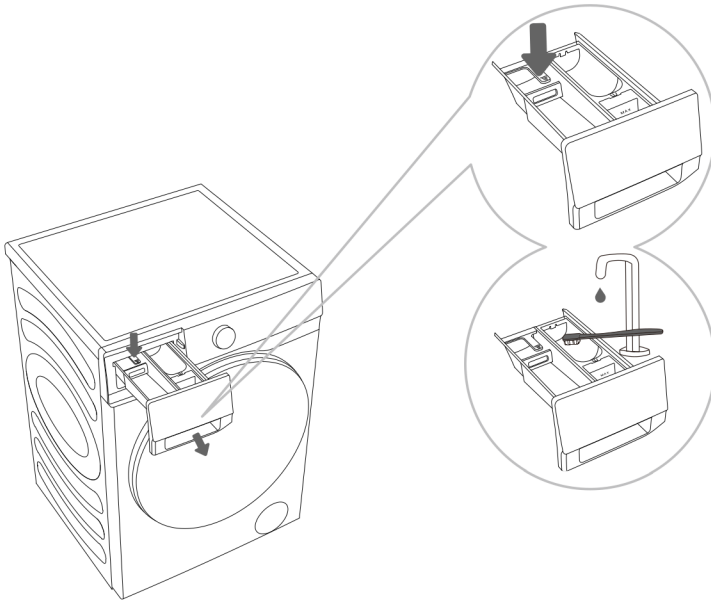

.....  
**1** To remove the detergent compartment from the housing, press the small tab.  
.....

**2** Clean the detergent compartment under running water using a brush, and dry it. Also, remove any detergent residue from the bottom of the housing. Remove the conditioner insert (softener insert) from the detergent compartment. Wash all parts under running water, and conditioner insert (softener insert) into detergent compartment and re-insert them into the detergent compartment housing.

 Do not wash the detergent compartment in a dishwasher.

# CLEANING THE WATER SUPPLY HOSE, DETERGENT DISPENSER HOUSING, AND RUBBER DOOR GASKET

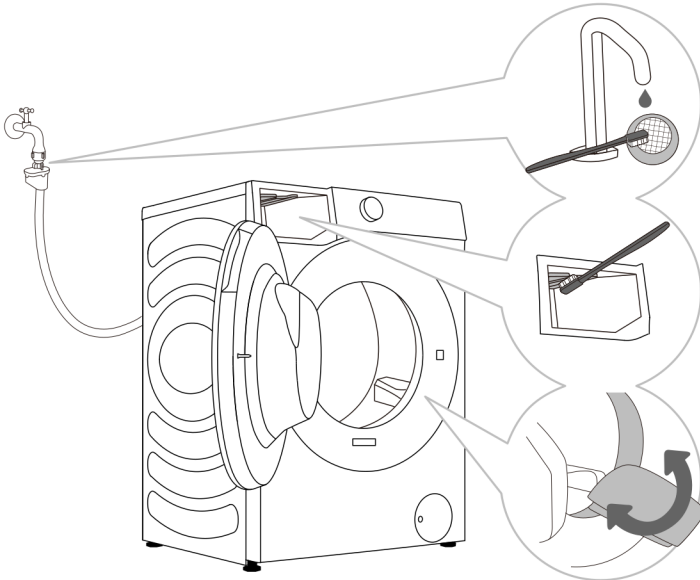

.....

**1** Clean the net filter often under running water.

.....

**2** Use a brush to clean the entire washer dryer rinsing section, especially the nozzles on the upper side of the rinsing chamber.

.....

**3** After every wash, wipe the rubber door seal to extend its useful life.



# CLEANING THE PUMP FILTER

⚠ During cleaning, some water may be spilled. It is therefore recommended to place an absorbent cloth on the floor.

Make sure the water has cooled down before you release it from the appliance.

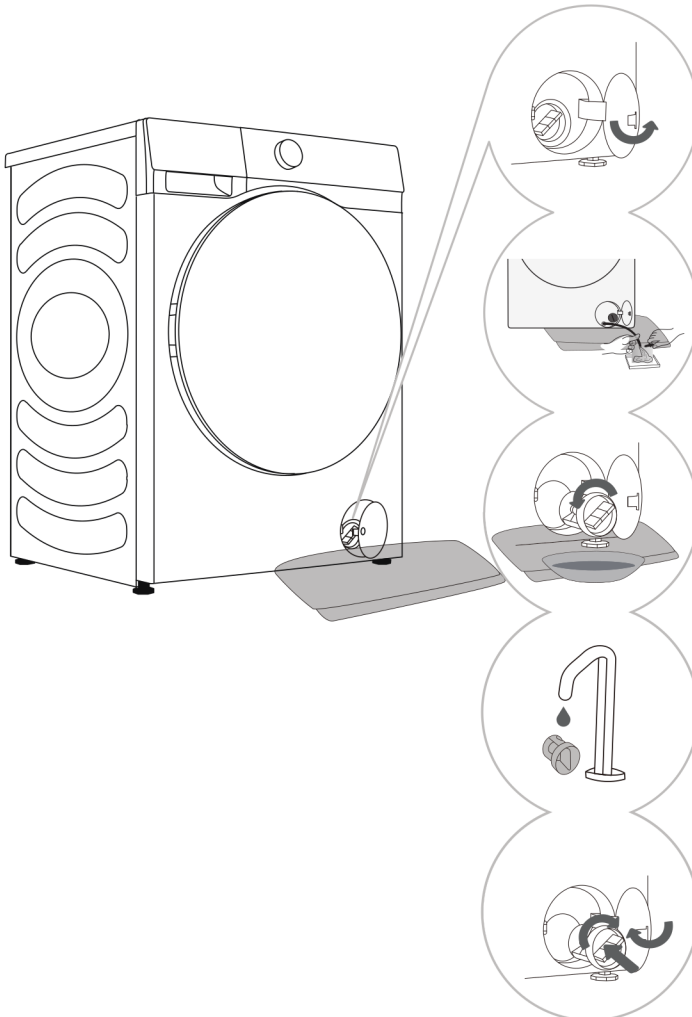

**1** Open the pump filter cap.  
Style1: Press the door cover and automatically pop open.  
Style2: Open the pump filter cap using a suitable tool.  
The style depends on the model.

**2** Place a towel under the filter door.  
If the machine has an emergency drain pipe, pull out emergency drain pipe of machine. Put end of emergency drain pipe into a container.  
If the machine doesn't have an emergency drain pipe, place a container under the pump filter.  
The style depends on the model.  
Rotate emergency drain pipe plug and remove it after it becomes loose Until water runs off naturally.  
Reinstall emergency drain pipe plug.

**3** Rotate the pump filter slowly in the counter-clockwise direction. Pull out and remove the pump filter.

**4** Clean the pump filter under running water.

**5** Replace the pump filter as shown in the figure and fasten it by rotating in the clockwise direction.  
For a good seal, the filter gasket surface should be clean.

⚠ The pump filter must be timely cleaned, especially after washing very fleecy, woolly, or very old laundry.

⚠ Also clean the pump filter if the appliance can not start the spinning cycle or when there is debris in the pump (buttons, coins, hair pins or clips etc.).

# CLEANING THE WASHER DRYER EXTERIOR

**⚠ Always disconnect the washer dryer from the power mains before cleaning.**

Clean the washer dryer exterior and display unit using a soft damp cotton cloth and water. Then, use a soft dry cloth to dry the appliance.

**⚠ Do not use any solvents, abrasive cleaners, or cleaning agents that could damage the appliance (please observe the recommendations and warnings provided by the cleaning agent).**

If necessary, wipe the appliance door with a damp cloth, and then dry with a dry soft cloth as well.

**⚡ Do not clean the washer dryer with a jet of water!**

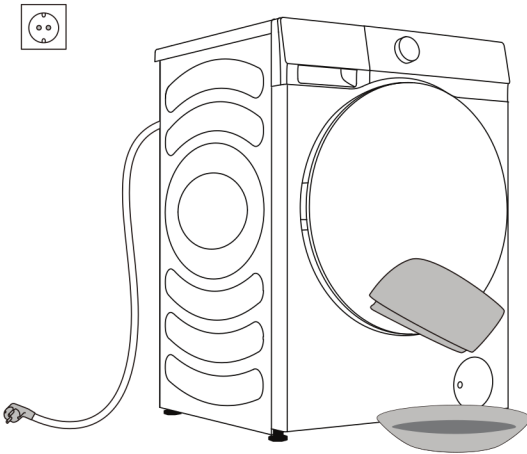

# TROUBLESHOOTING

## WHAT TO DO ...?

The washer dryer shall automatically control the operation of particular functions during the washing cycle. If any irregularity is identified, this will be indicated by reporting (F:XX) on the display. The washer dryer will report the error until it is switched off. Disturbances from the environment (e.g. the power grid) may result in various error reports (see TROUBLESHOOTING TABLE). In such case:

- Switch off the washer dryer and wait for a few seconds.
- Switch on the washer dryer and repeat the washing programme.
- Most errors during operation can be resolved by the user (see TROUBLESHOOTING TABLE).
- If the error persists, call an authorized service unit.
- Repairs may only be carried out by an adequately trained person.
- Repair or any warranty claim resulting from incorrect connection or use of the washer dryer shall not be covered by the warranty. In such cases, the costs of repair shall be charged to the user.

## DRY FAULT

Phenomenon	Recommended processing method
<b>Washer dryer does not carry out dry process</b>	<ul style="list-style-type: none"><li>• Check whether the dry program is set up.</li><li>• Check whether the water tap is unopened.</li><li>• Check whether the door is well closed.</li><li>• Check whether the dry clothes are excessive (refer to the program table and check corresponding capacity of the program), and take out part of the clothes to dry again.</li></ul>
<b>Dry is not sufficient</b>	<ul style="list-style-type: none"><li>• Check whether the dry clothes are excessive. If so, it will cause unsatisfactory dry effects and folds in clothes. Please divide the clothes in the drum into two parts for drying separately.</li><li>• Check whether the clothes (such as thicker cotton, etc.) that are not easy to dry are mixed with the clothes that easy to dry (such as chemical fiber, etc.). Please dry the clothes of different types separately or dry them again.</li></ul>
<b>Dry time is too long</b>	<ul style="list-style-type: none"><li>• Check whether the drying clothes are excessive (refer to the program table and check corresponding capacity of the program), and take out part of the clothes to dry again.</li><li>• Clothes are not fully dewatered. Please spin the clothes before drying them.</li><li>• More thicker clothes (denim, etc.).</li></ul>

⚡ The warranty does not cover the errors or failures resulting from disturbances from the environment (lightning strike, power grid failures, natural disasters etc.).

# TROUBLESHOOTING AND ERROR TABLE

Problem/error	Indication on the display unit and problem description	What to do?
F01	Water inflow fault	Check the following: <ul style="list-style-type: none"> <li>• Is the water supply tap open and is the pressure too low?</li> <li>• Is the water supply hose pinched?</li> <li>• Is the filter on the water supply hose clogged?</li> <li>• Is the hose frozen?</li> </ul>
F03	Drainage fault	Check the following: <ul style="list-style-type: none"> <li>• Is the hose pinched, does the water flow through it?</li> <li>• Is the filter on the drain hose clogged?</li> <li>• Is the hose frozen?</li> </ul>
F04/F05/F06/ F07/F23	Electronic module fault	Switch off the appliance; Press the "Power" for 2 seconds. Press the "start/pause" button again. If the error reoccurs, call a service technician.
F24	Water level reaches overflow level	Stop the programme by pressing the START/PAUSE button. Restart the programme. If the appliance continues to pump water into the tub, close the water tap and call a service technician
F13	Error while locking the door	Door is closed, but it cannot be locked. Switch off the washer dryer. Switch it back on and restart the washing programme. If the error reoccurs, call a service technician.
F14	Error while locking the door	Door is closed, but it cannot be unlocked. Turn off the appliance, then turn it back on. If the error reoccurs, call a service technician.
Unb	Unb Unbalance alarm	Unbalance alarm shall be solved by the following methods 1.Laundry winding Press the "Power" for 2 seconds to shutdown the washing machine, open the door, shake the clothes and put them back into the washing machine, then select the single dewatering program to try again. 2.Too light-weighted laundry Press the "Power" for 2 seconds for shutdown, open the door, put in one or two towels, and then select the single dewatering program to try again.
F15-F18	In case of abnormal drying	You can press and hold the "Power" button for 2s to shut down this machine, and restart this machine.

# SERVICING

## Before calling a service technician

When you contact a service centre, please state your washer dryer's type (1).

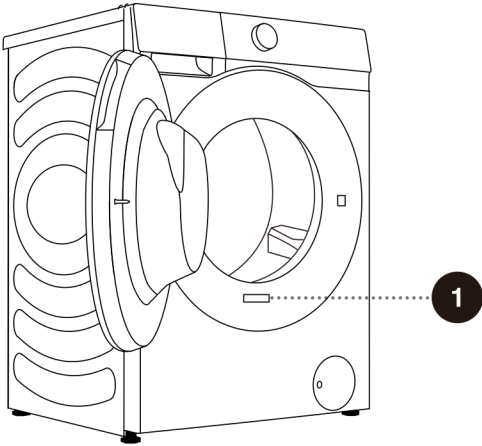

Type, code/ID, model, and serial number are indicated on the rating (type) plate located on the front side of the washer dryer door opening.

- ⚠ In case of a defect, only use approved spare parts by authorized manufacturers.
- ⚠ Repair or any warranty claim resulting from incorrect connection or use of the washer dryer shall not be covered by the warranty. In such cases, the costs of repair shall be charged to the user.



1

**Hisense** Washer-dryer  
XXXXXXXXXX  
XXX-XXXV~ XXHz IPX4  
Washing Capacity:XX kg (XXXXW)  
Drying Capacity:X kg (XXXXW)

  
**RoHS**

# RECOMMENDATIONS FOR WASHING AND ECONOMIC USE YOUR WASHER DRYER

Wash new coloured garments separately the first time.

Wash heavily soiled laundry in smaller amounts, with more powder detergent or with a pre-wash cycle.

Apply a special stain remover on stubborn stains before the wash. We recommend referring to STAIN REMOVAL TIPS.

If you often wash laundry at low temperatures and with liquid detergents, bacteria may spawn which can cause odour in the washer dryer. To prevent such odour, we recommend occasionally running the Drum Clean.

We recommend avoiding washing very small amounts of laundry as this will lead to excessive use of energy and poorer washer dryer performance.

Loosen any folded laundry before putting it into the drum.

Only use detergents for washer dryer.

Add powder or liquid detergents as instructed by the manufacturer, according to the washing temperature and selected washing programme.

When using highly concentrated detergents, use special-purpose dosing cups (supplied with the detergent) and place them directly in the appliance drum.

If water hardness exceeds 14°dH, water softener should be used. Heater damage resulting from incorrect use of water softeners shall not be covered by the warranty. Check the information on water hardness with your local water supply company or authority.

Use of chlorine-based bleaches is not recommended as they can damage the heater.

If you use a descaling agent, bleach, or dye, only use the kind that is suitable for use in the appliance.

Do not use solvents or similar chemicals (e.g. paint thinner, turpentine, gasoline etc.)!

Do not add hardened lumps of powder detergent into the detergent dispenser as this may clog the piping in the washer dryer.

When using thick liquid laundry care products, we recommend diluting them with water to prevent clogging the detergent compartment drain.

Liquid detergents are intended for washing programmes without a prewash cycle.

At higher spinning rates, there will be less residual moisture in the laundry. As a result, drying in a tumble dryer will be more economical and faster.

# STAIN REMOVAL TIPS

Before using special-purpose stain removers, try using the natural methods that do not harm the environment on less stubborn stains.

However, prompt action is required! Soak the stain with an absorbent sponge or a paper towel; then, rinse with cold (lukewarm) water – but never with hot water!

Stains	Stain removal
<b>Mud</b>	When the stain is dry, first scrape it off the garment before washing it in the washer dryer. If the stain is stubborn, soak it with an enzyme-based stain remover before the wash. If the stain is not stubborn, wash the laundry with liquid detergent or powder detergent and water before the wash.
<b>Antiperspirant</b>	Before washing in the washer dryer, apply liquid detergent onto the laundry. Apply stain removers on any stubborn stains. Alternatively, use oxygen-based bleach for the wash.
<b>Tea</b>	Soak or rinse the laundry in cold water and add stain remover if necessary.
<b>Chocolate</b>	Soak or rinse the laundry with lukewarm soapy water. Then, apply lemon juice and rinse.
<b>Ink</b>	Before washing in the washer dryer, apply stain removers on the stain. You may also use denatured alcohol. Turn the garment inside out and place a paper towel under the stain. Use the alcohol on the back side of the stain. At the end of the process, thoroughly rinse the garment.
<b>Felt tip pens</b>	Dilute some starch in water and apply it to the stain. When it dries, scrape it off with a brush; then, wash the garment in the washer dryer.
<b>Baby food</b> (urine, mud, food stains)	Before washing in the washer dryer, soak the stains in lukewarm water for at least half an hour. For easier stain removal, add an enzyme-based stain remover.
<b>Grass</b>	Before washing in the washer dryer, soak the laundry in an enzyme-based stain remover. Grass stains can also be removed by soaking (for approx. 1 hour) in diluted lemon juice or distilled vinegar.
<b>Eggs</b>	Soak the garment in an enzyme-based stain remover. Soak in cold water for at least 30 minutes or a few hours if the stains are stubborn. Then, wash in the washer dryer.
<b>Coffee</b>	Soak the garment in salt water. If the stain is not fresh, soak it with a mixture of glycerine, ammonia and alcohol.
<b>Shoe polish</b>	Apply cooking oil to the stain and rinse.

<b>Stains</b>	<b>Stain removal</b>
<b>Blood</b>	Fresh stain – rinse the garment with cool water and wash it in the washer dryer. Dried stain – soak the garment in an enzyme-based stain remover. Then, wash in the washer dryer. If the stain does not vanish, try to remove it with a bleach suitable for your garment.
<b>Glue, chewing gum</b>	Place the garment in a bag and put it in the freezer until the stain hardens. Then, remove it with a blunt knife. Then, dilute the stain with a prewash stain remover and rinse thoroughly. Then, wash the laundry as usual.
<b>Makeup</b>	Use a stain remover for the prewash; then, wash in the washer dryer.
<b>Butter</b>	Before washing in the washer dryer, apply stain remover to the stain. Then, rinse with hot water (as hot as the fabric will allow).
<b>Milk</b>	Soak the garment in an enzyme-based stain remover. Soak for at least 30 minutes or a few hours if the stains are stubborn. Then, wash in the washer dryer.
<b>Fruit juice</b>	Apply a mixture of salt and water on the stain. Leave to take effect for a while, then rinse. You can apply sodium bicarbonate, distilled vinegar or lemon juice on the stain before washing in the washer dryer. For old stains, use glycerine. After 20 minutes, rinse with cold water, then wash the laundry in the washer dryer.
<b>Wine</b>	Soak the laundry in cold water for at least 30 minutes. Also, use a stain remover. Then, wash in the washer dryer.
<b>Wax</b>	Put the garment into the freezer until the wax hardens. Then, scrape it off. Remove the remaining wax by placing a paper towel onto the stain, and then heat it with an iron until the paper absorbs the wax.
<b>Sweat</b>	Before washing in the washer dryer, rub liquid detergent thoroughly into the stain.
<b>Chewing gum</b>	Put the garment into the freezer until the chewing gum hardens. Then, scrape it off. Then, wash in the washer dryer.



# DISPOSAL

**Packaging** is made of environmentally friendly materials that can be recycled, disposed of, or destroyed without any hazard to the environment. To this end, packaging materials are labelled appropriately.



**The symbol** on the product or its packaging indicates that the product should not be treated as normal household waste. Take the product to an authorized collection centre for waste electric and electronic equipment processing.

When **disposing** of the washer dryer at the end of its useful life, remove all power cords, and destroy the door latch and switch to prevent the door from locking or latching (child safety).

This appliance is marked according to the European directive on waste (WEEE).

Correct **disposal** of the product will help prevent any negative effects on the environment and health of people, which could occur in case of incorrect product removal. For detailed information on removal and processing of the product, please contact the relevant municipal body in charge of waste management, your waste disposal service, or the store where you bought the product.

# TYPICAL CONSUMPTION TABLE

## Programme Instructions

1. The Eco 40-60 programme is able to clean normally soiled cotton laundry declared to be washable about 40°C to 60°C together in the same cycle, and that this programme is used to assess the compliance with the EU ecodesign legislation.
2. The power consumption of the off-mode is 0.49W.
3. The most efficient programmes in terms of energy consumption are generally those that perform at lower temperatures and longer duration.
4. Loading the household washer dryer up to the capacity indicated by the manufacturer for the respective programmes will contribute to energy and water savings.
5. Correct use of detergent, softeners and other additives. Do not apply excessive detergent. This may affect the washing results adversely.
6. Periodic cleaning, including optimal frequency, and limescale prevention and procedure.
7. Noise and remaining moisture content are influenced by the spinning speed: the higher the spinning speed in the spinning phase the higher the noise and the lower the remaining moisture content.
8. The product information and QR code are reflected in the energy consumption label the product registration information can be obtained by scanning the QR code.
9. The information of standard programmes.

Program	Selected Temperature (°C)	Rated Capacity (kg)	Maximum temperature in drum (°C)	Program duration (h:min)	Energy consumption (kWh/cycle)	Water consumption (litres/cycle)	Remaining moisture content (%)	Maximum speed reached (rpm)
Eco40-60 full load	-	10.5	32	3:59	0.840	64.0	53.90	1400
Eco40-60 half load	-	5.25	22	3:00	0.310	44.0	53.90	1400
Eco40-60 1/4 load	-	2.5	23	2:20	0.215	31.0	53.90	1400
Wash and Dry full load	-	6.0	28	7:59	3.800	102.0	-	1400
Wash and Dry half load	-	3.0	22	5:29	1.980	70.0	-	1400
Cotton	20	10.5	20	2:09	0.300	122.0	55.00	1400
Cotton	60	10.5	56	3:29	2.130	122.0	55.00	1400
Synthetics	40	5.0	40	2:35	0.980	92.0	35.00	1400
Quick 15'	20	1.0	20	0:15	0.044	25.0	75.00	800

The values given for programmes other than the Eco 40-60 programme and the wash and dry cycle are indicative only.

The entry mode of wash and dry cycle is to select the Eco 40-60 programme, and press the dry level button once.

☼ Maximum or nominal load applies to laundry prepared pursuant to the IEC 60456 standard.

☼ **Due to deviations in terms of type and amount of laundry, spinning, power supply oscillation, and environment temperature and humidity, the programme duration and power consumption values measured at the end user may differ from the ones stated in the table.**

*We reserve the right to any changes and errors in the instructions for use.*

## Wi-Fi CONNECTION

Enter the "Settings" interface on your smartphone or tablet PC, enable the Bluetooth and Wireless Connection, and connect to the wireless network.

### NOTE

This device can support the 2.4 GHz Wi-Fi.

When the Wi-Fi function is turned on, the machine's energy consumption will increase. But the Wi-Fi power is just less than 2W, so it has no effect on the machine's energy efficiency rating.

## Download

In the APP Store (Google Play Store, Apple App Store) on your smartphone or tablet PC, find the ConnectLife app, download and install it.

### NOTE

In order to improve performance and experience, the application may be updated without notification.

## Log in



You need to log in to ConnectLife with your account first. If you do not have a ConnectLife account, you will need to create a new one. Please refer to the App Instructions for details.

### NOTE

If you already have a Google account, you can use your Google account to log in directly.

## Device Binding



1. Open ConnectLife on your smartphone or tablet PC;
2. Bind your device on ConnectLife as follows:
  - A. Click "Start here Add appliances" in "Home" page, or click "Add appliances" in "Devices" page, or click "+".
  - B. Select "Washing Machine" or click "Scan QR/BAR code" or "Manual entry" below.
  - C. Scan the QR/BAR code on the device or enter the AUID/SN manually. If you can not find it, click  for instructions.
  - D. Click "SET UP APPLICATION"
  - E. Read the instructions, operate the device into the Networking and Binding state, and click "NEXT".
  - F. At this time, the app starts to search for devices, and you can select the device to be connected to the network from the search list; If it is not found, check your bluetooth whether turn on. Bluetooth should be keep it on at all time. And then click "NEXT".
  - G. Select your home Wi-Fi, enter the password, Then click the "CONNECT". The appliance will start networking and binding.
  - H. After binding successfully, you can set the device name and room.
  - I. Now, the device can be control remotely by APP.

 When the  display light on the display window is not on, you cannot remotely control the machine through the mobile phone. To enable this function, long press the  button on the dashboard.

### NOTE

How to reset Wi-Fi and unbind all the binding relationship of the device:

1. Press the power key to start the device and make it connect to the network normally.
2. Press the last two keys simultaneously for 3 seconds, and the screen will display "E-b".
3. Shut down and restart the device to make a new binding.
4. After unbinding, the device must be restarted, or the unbinding will fail. Unbinding will delete users information stored in appliance before.
5. How to exit the network distribution mode:

If you want to quit when screen display "E-b", press  "simultaneously for 3 seconds, you can turn off the appliance by press  or wait for 5 minutes.

**Hisense**

life reimagined