

INTEX® OWNER'S MANUAL

Built-in Fast-Fill™ Electric Pump

Model AP619A 110 – 120 V~ 60 Hz 0.9 A

IMPORTANT SAFETY INSTRUCTIONS

151

READ AND FOLLOW ALL INSTRUCTIONS BEFORE USING THIS PRODUCT

⚠ DANGER

- To reduce the risk of electric shock: Always unplug this furnishing from the electrical outlet before cleaning.

⚠ WARNING

To reduce the risk of burns, fire, electric shock, or injury to persons:

- Infants have suffocated on inflatable mattresses. Never place infant aged birth to 15 months to sleep on this inflatable air mattress / air bed. Infants can suffocate on an underinflated or deflated mattress, on bedding, by co-sleeping with another person, and by entrapment between the mattress and bed frame or between the mattress and a vertical surface.
- Children can be entrapped between the inflatable mattress and an adjacent vertical surface. Provide at least a shoulder width space between the inflatable mattress/airbed and adjacent vertical surfaces such as walls, dressers or other objects.
- Always keep the inflatable mattress fully inflated when in use.
- Never introduce any flammable substance into the inflatable airbed, SUCH AS AEROSOL TIRE REPAIR PRODUCTS, as it may ignite or explode.
- For indoor household use only.
- Unplug from outlet before putting on or taking off parts.
- Close supervision is necessary when this furnishing is used by, or near children, invalids, or disable persons.
- Use this furnishing only for its intended use as described in these instructions. Do not use attachments not recommended by the manufacturer.
- Do not operate where aerosol (spray) products are being used or where oxygen is being administered.
- This is not a toy. Children must not be left unattended when using the airbed.
- Keep the storage bag away from babies and children. The storage bag is not a toy. When not in use, fold the bag and put it away out of the reach of children.
- Do not walk, stand on or jump on or use the airbed as a trampoline.
- Do not use on or near water. This is not a raft.
- Do not set up bed near stairs, doors, sharp edges or breakable objects. Provide adequate space between bed and objects to avoid entrapment.
- Make sure the area is flat, smooth, free of sharp objects that could puncture the bed and keep away from ledges.
- Keep pets away from the airbed. Pets may puncture the surface of the bed.
- Avoid sleeping on the edge of the airbed. Edges produce less support than the middle of the bed.
- Do not operate air pump for more than 5 minutes at a time. Let pump cool at least 15 minutes between use.
- Unplug electrical power cord when not in use. To disconnect, turn all controls to the off position, then remove plug from outlet.
- Never operate the furnishing with the air openings blocked. Keep the air openings free of lint, hair, and the like. Never drop or insert object into any opening.
- Never operate this furnishing if it has a damaged cord or plug, if it is not working properly, if it has been dropped or damaged, or dropped into water. Return the furnishing to a service center for examination and/or repair.
- If the AC supply cord is damaged, it must be replaced by the manufacturer or its service agent in order to avoid a hazard.
- Do not run cord under carpeting. Do not cover cord with throw rugs, runners, or similar coverings. Do not route cord under furniture or appliances. Arrange cord away from traffic area and where it will not be tripped over. Keep the cord away from heated surfaces.

FOLLOW THESE RULES AND ALL INSTRUCTIONS TO AVOID SUFFOCATION, PROPERTY DAMAGE, ELECTRIC SHOCK, BURNS OR OTHER INJURY.

⚠ CAUTION

- To reduce the risk of electric shock or injury, use indoors only, do not expose to rain. Store indoors.

READ AND SAVE THESE INSTRUCTIONS

SERVICING OF A DOUBLE-INSULATED PRODUCT:

In a double-insulated product, two systems of insulation are provided instead of grounding. No grounding means is provided on a double-insulated product, nor should a means for grounding be added to the product. Servicing of a double-insulated product requires extreme care and knowledge of the system, and should be done only by qualified service personnel. Replacement parts for a double-insulated product must be identical to those parts in the product. A double-insulated product is marked with the words "DOUBLE INSULATION" or "DOUBLE INSULATED" and with the symbol □.

151

OPERATING INSTRUCTIONS

General

- This appliance has a polarized plug (one blade is wider than the other). This plug will fit in a polarized outlet only one way. If the plug does not fit fully in the outlet, reverse the plug. If it still does not fit, contact a qualified electrician to install the proper outlet. Do not change the plug in any way.

Maintenance instructions:

- No air pump maintenance is required. Air pump has no user serviceable parts.
- For cleaning use only mild soapy solution. Do not use any chemicals.
- In case of repairs, use only common PVC repair glue and patches.

PARTS REFERENCE

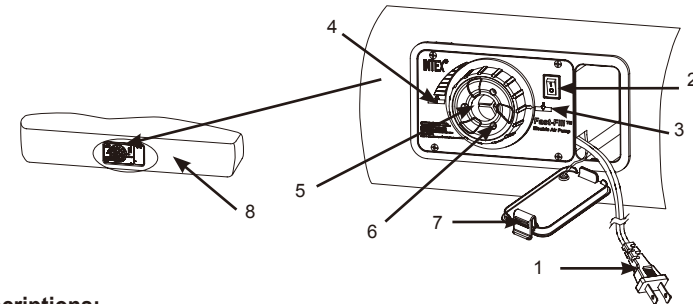

Part Descriptions:

- | | | |
|-----------------------|-------------------------------------|---------------------------|
| 1. AC line cord | 4. Deflation mark (⬇) | 6. Control dial |
| 2. Switch | 5. Air passage & control dial valve | 7. Cord compartment cover |
| 3. Inflation mark (⬆) | | 8. Airbed |

NOTE: Drawings for illustration purpose only. May not reflect actual product. Not to scale. Due to a policy of continuous product improvement, Intex reserves the right to change specifications and appearance, which may result in updates to the instruction manual, without notice.

INFLATION

- Move the product to the power source location. Open line cord compartment cover. See Fig (1).
- Plug in the AC line cord into an AC electrical outlet. See Fig (2).

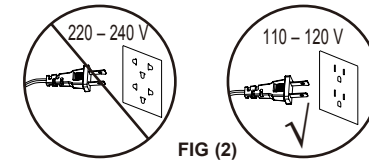
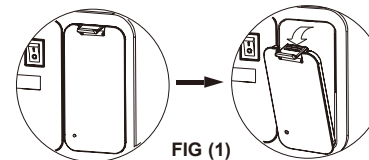

- Turn the control dial clockwise until arrow points to the inflation mark (⬆). See Fig (3).
- Press "I" to switch ON. See Fig (4).
- When the airbed is fully inflated to the desired firmness, press "O" to switch OFF. See Fig (5).

READ AND SAVE THESE INSTRUCTIONS

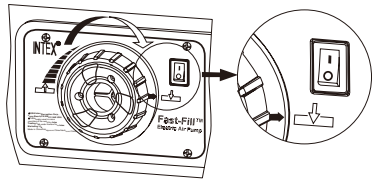

FIG (3)

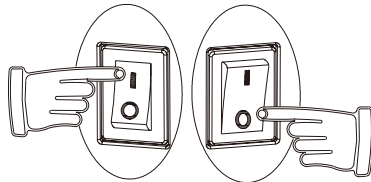

FIG (4)

FIG (5)

151

- Lie down on the airbed to test the firmness.
- If the sleeping surface is too hard, adjust the firmness by turning the control dial counterclockwise gradually until air starts to exit through the air passage. See Fig (6). Turn the control dial fully clockwise when the desired firmness is achieved. See Fig (7). If the airbed becomes too soft repeat step #3 thru #7 as necessary.
- Disconnect the AC line cord from the wall socket, place it inside the cord compartment and close the cover. Make sure the power cords are free of twist, kink and knot.

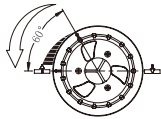

FIG (6)

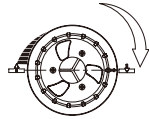

FIG (7)

IMPORTANT NOTE

Proper inflation of the airbed.

The ambient temperatures of air have an effect on the airbed internal pressure. At low ambient temperature the air will contract within the airbed and the airbed will feel softer: add air as necessary. At high ambient temperature the air within the airbed will expand significantly and the airbed will become hard and may burst: release air to avoid damage to the airbed or to soften the feel. **Do not** expose the airbed to extreme temperatures (hot or cold).

Stretching is a natural characteristic of new vinyl. During initial use, the airbed may become soft and require additional inflation to maintain desired firmness. This is normal for the first few days of use.

Dimensions shown are approximate and will vary due to the vinyl temperature and the air temperature.

In no event shall Intex, their authorized agents or employees be liable for damages (such as pin holes) to the airbed caused by negligence, ordinary wear and tear, abuse and carelessness, or external forces.

DEFLATION

- Open line cord compartment cover. See Fig (1).
- Plug in the AC line cord into an AC electrical outlet. See Fig (2).
- Turn the control dial counterclockwise until arrow points to deflation mark (↑). See Fig (8).

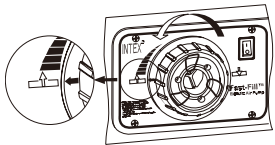

FIG (8)



FIG (9)

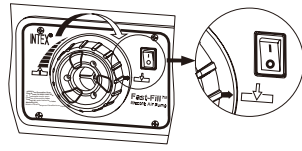

FIG (10)

READ AND SAVE THESE INSTRUCTIONS

- Press "I" to switch ON. See Fig (4).
- When the airbed is completely deflated, begin rolling the airbed from the foot of the airbed towards the head of the airbed where the pump is located. See Fig (9).
- When all air is removed from the airbed, press "O" to switch OFF. See Fig (5).
- Turn the control dial fully clockwise. See Fig (10).
- Disconnect the AC line cord from the wall socket, place it inside the cord compartment and close the cover. Make sure the power cords are free of twist, kink and knot.

151

INFLATION OPTION

- If electrical power is not available then a conventional foot or manually operated air pump can be connected to the control dial valve for inflation. See Fig (11).
- Turn the control dial clockwise until arrow points to the inflation mark (↓).
- Insert air pump nozzle to the control dial valve to inflate the airbed.

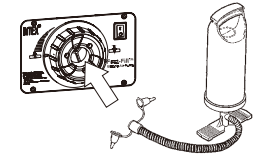

FIG (11)

IMPORTANT

Inflate only with a low pressure inflator. Do not over inflate. Fill with cold air only.

STORAGE INSTRUCTIONS

- Deflate the airbed following the "DEFLATION" instructions.
- Turn the control dial counterclockwise until arrow points to deflation mark (↑). See Fig (8).
- Make sure the airbed is clean and dry.
- Lay bed flat with sleeping surface facing upwards and follow the folding steps on Figs (12 - 16). Fold the airbed loosely and avoid sharp bends, corners and creases which can damage the airbed.

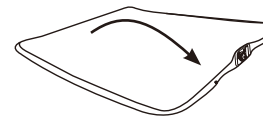

FIG (12)



FIG (13)

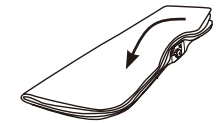

FIG (14)

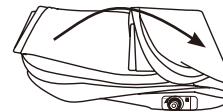

FIG (15)



FIG (16)

- Turn the control dial fully clockwise. See Fig (10).
- Place the airbed inside the storage bag and store in a dry, cool storage location.

©2015 Intex Marketing Ltd. - Intex Development Co. Ltd. - Intex Trading Ltd. - Intex Recreation Corp.
 All rights reserved/Tous droits réservés/Todos los derechos reservados/Alle Rechte vorbehalten. Printed in China/Imprimé en Chine/Impreso en China/Gedruckt in China.
 ®™ Trademarks used in some countries of the world under license from®™ Marques utilisées dans certains pays sous licence de/Marcas registradas utilizadas en algunos países del mundo bajo licencia de/Warenzeichen verwendet in einigen Ländern der Welt in Lizenz von/Intex Marketing Ltd. to/a/an Intex Trading Ltd., Intex Development Co. Ltd., G.P.O Box 28829, Hong Kong & Intex Recreation Corp., P.O. Box 1440, Long Beach, CA 90801 • Distributed in the European Union by/Distribué dans l'Union Européenne par/Distribuido en la union Europea por/Vertrieb in der Europäischen Union durch/Intex Trading B.V., Venneveld 9, 4705 RR Roosendaal - The Netherlands
 www.intexcorp.com Consumer Service 1-800-234-6839



READ AND SAVE THESE INSTRUCTIONS