

RONDA 8 SEATER CORNER DINING SET

Assembly Instructions - Please keep for future reference

7473441

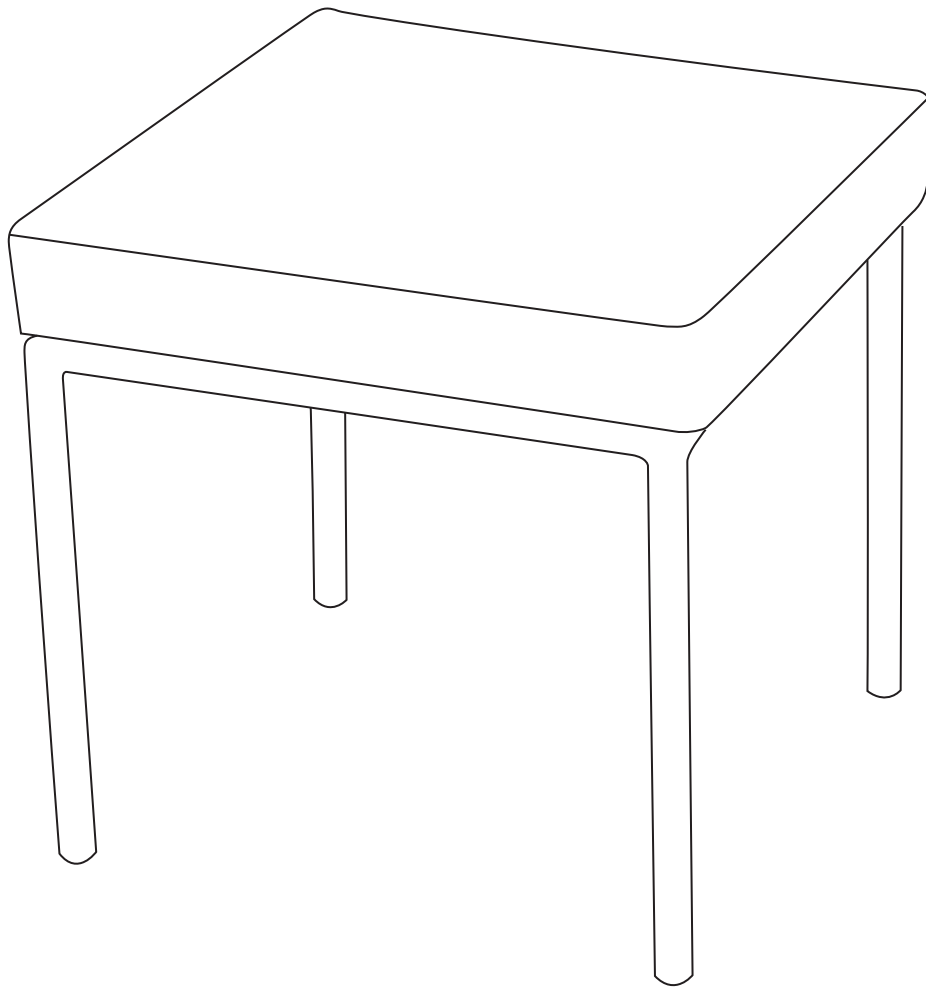

Dimensions

Width -43cm
Depth -43cm
Height -36.5cm

Important - Read these instructions fully before starting assembly

If you need help or have damaged or missing parts, call the Customer Helpline: 03456400800
For further assistance please visit <http://www.argos-support.co.uk/>



Safety and Care Advice

Important - Please read these instructions fully before starting assembly

- Check you have all the components and tools listed on page 2 & 3.
- Remove all fittings from the plastic bags and separate them into their groups.
- Keep children and animals away from the work area, small parts could choke if swallowed.
- Make sure you have enough space to layout the parts before starting.
- Do not stand or put weight on the components during assembly, this could cause damage.
- Assembly on a soft level surface to avoid damaging the unit or your floor.
- Parts of the assembly will be easier with 2 people.
- Dispose of all packaging carefully and responsibly.
- Do not stand on this ottoman.
- Warning: The unit weighs approximately 7.8 kgs. Please lift with care.

Care and maintenance

- Wash frame parts with mild soap and water, rinse thoroughly, and dry completely. Do not use bleach, acid, or other solvents on the frame parts.
- We recommend the use of furniture covers when not in use.
- Inspect and tighten all bolts and fasteners on a regular basis to ensure the proper performance and safety of your ottoman.
- In order to prolong the life and beauty of your ottoman, we recommend that it be stored in a dry and protected area when not in use .

Components - Fittings

Please check you have all the fittings listed below

Note: The quantities below are the correct amount to complete the assembly.

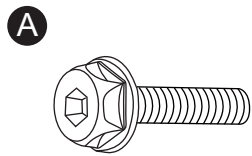

M6 x 15mm Bolt x 4

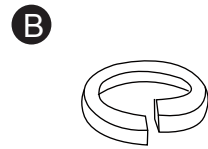

D10 Spring Washer x 4

Components - Parts

Please check you have all the parts listed below

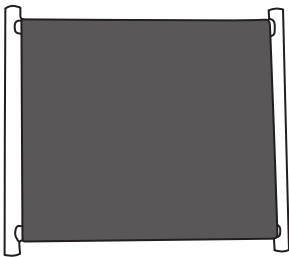

1 Seat Assembly x 1

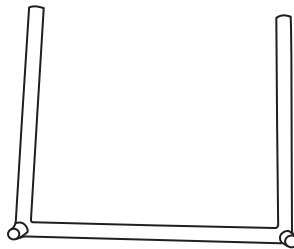

2 Leg x 2

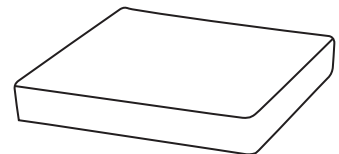

3 Seat Cushion x 1

Tools required



4mm Hex Key



10mm Hex Key

Ruler - Use this ruler to help correctly identify the screws

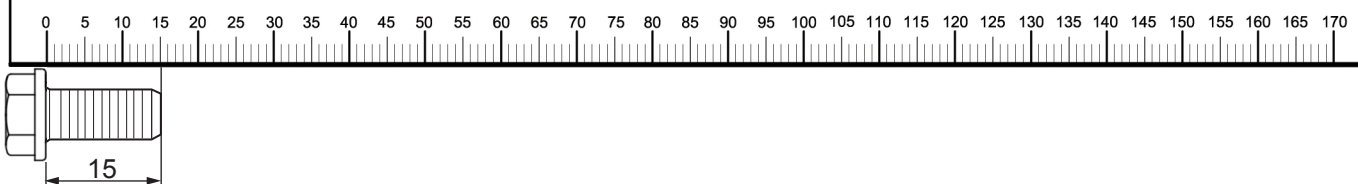

Assembly Instructions

Step 1

Place the seat assembly **1** onto a non-abrasive surface, such as a carpet, with its holes facing upwards. Insert the legs **2** into the seat assembly **1** by using bolts **A**, spring washers **B**. Make sure that all of the bolts have been tightened completely.

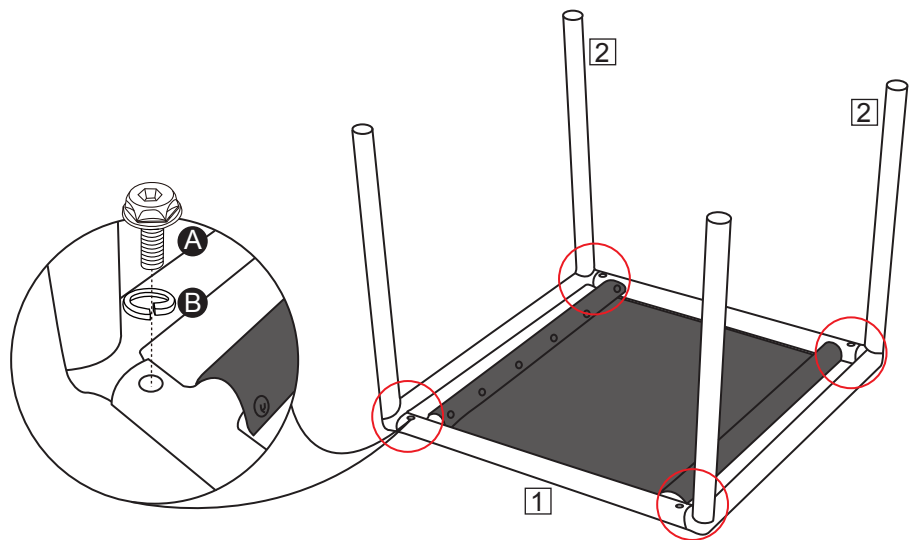

Step 2

Turn the ottoman to its upright position. Place the seat cushion **3** onto the ottoman. Secure the cushion to the ottoman by using the velcro straps.

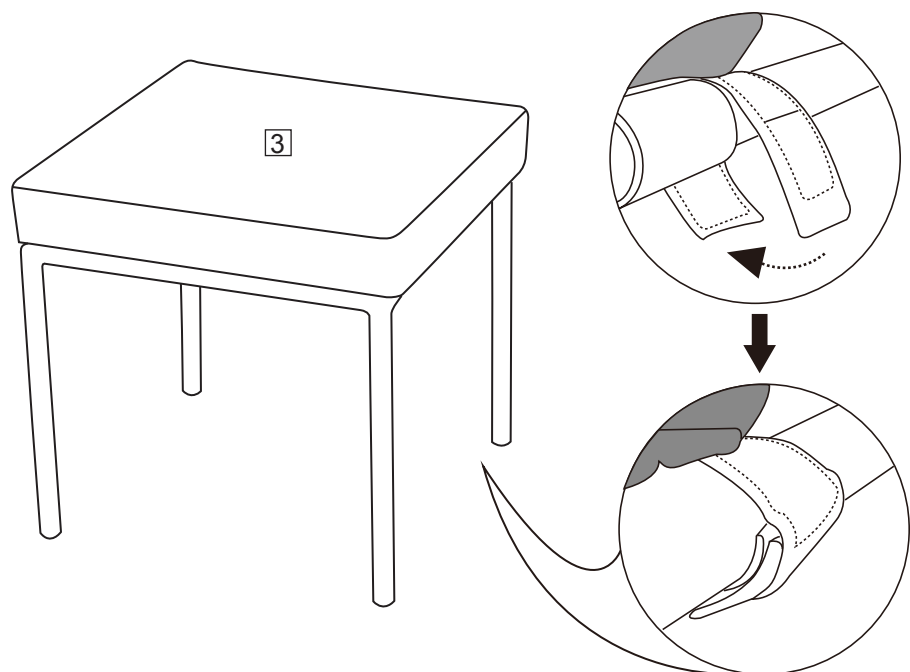

Assembly is completed.

If you need help or have damaged or missing parts, call the Customer Helpline: 03456400800

For further assistance please visit <http://www.argos-support.co.uk/>

Retailer: Argos

Address: 489-499 Avebury Boulevard Saxon Gate West, Central Milton Keynes Bucks, MK9, 2NW