

BUSH

Instruction manual

Bluetooth Speaker BT870S

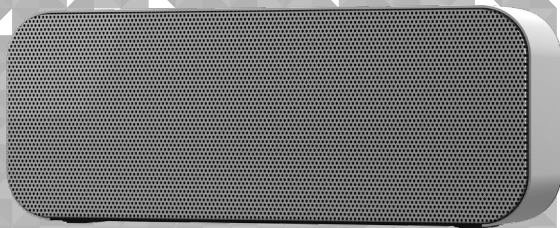



You'll soon be enjoying your new Bluetooth Speaker.

It all begins here, with your instructions. Don't worry, there's nothing too technical coming up. Just simple, step-by-step guidance to get you up and running quickly. Sound good? Then let's get started.



Help and Guidance

We're here to help you get the most from your Bluetooth speaker. Should you require any guidance, a simple solution can often be found online at:

www.argos-support.co.uk

If you still require further assistance, call one of our experts on **0345 600 3021**.

If you require any technical guidance or find that your product is not operating as intended, a simple solution can often be found in the **Troubleshooting**

BUSH



Contents

1 Safety information

General safety information	6
Power source	6
Moisture and water	6
Ventilation	7
Heat sources and flames	7

2 Getting to know your Bluetooth speaker

Positioning the Bluetooth speaker	12
Power connection	12

3 Using your Bluetooth speaker

Power on	16
Connect to a Bluetooth device	16
Adjusting the volume	17
Listening to Music/Audio using Bluetooth	18
Using as a Mobile handsfree speakerphone	18
Aux in mode	19

4 Other information

Technical specification	22
-------------------------	----

5 Product support

Troubleshooting	26
Help and assistance	27
Disposal	28
Your Bush Guarantee	29

section of these instructions, or online at www.argos-support.co.uk if you still require further assistance, call one of our experts on 0345 600 3021.



This page is left intentionally blank





Safety information

1

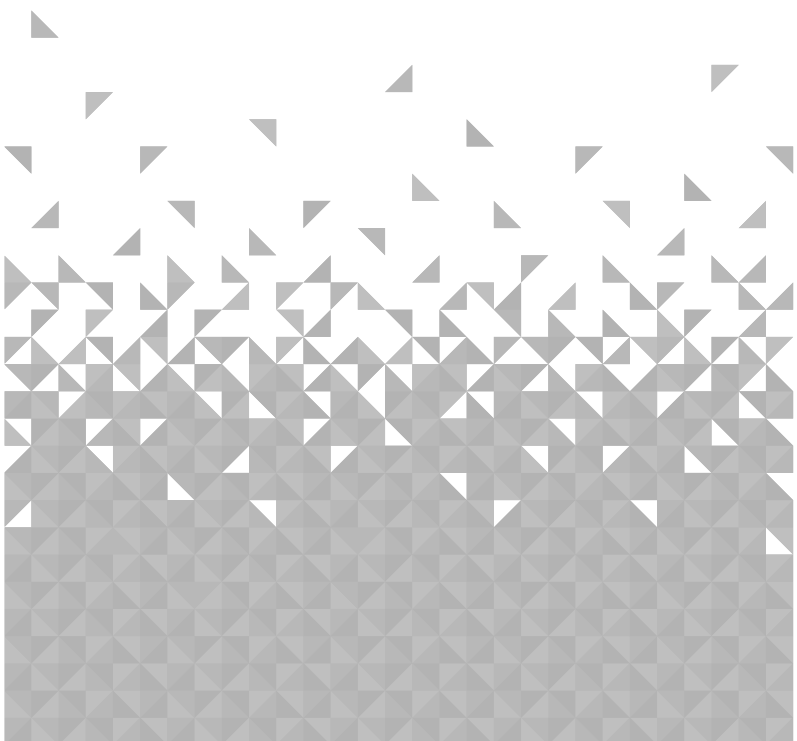



Safety information

Important - Please read these instructions fully before installing or operating

General safety information

Keep the product and all its parts out of reach of small children.

This product is not intended for use by persons (including children) with reduced physical, sensory or mental capabilities, or lack of experience and knowledge, unless they have been given supervision or instruction concerning the use of the appliance by a person responsible for their safety.

- Do not attempt to open the product. This product does not contain any user serviceable parts. Unauthorised handling of the device may damage it and will void your warranty.
- Do not use your Bluetooth speaker near emergency/intensive care medical equipment; if you have a pacemaker fitted or during an electrical storm.



To avoid possible hearing damage, do not listen to this Bluetooth speaker at high volume levels for long periods of time. Always keep the volume within reasonable limits.

Power source

Only use the USB charging cable that came with the product. Using an unauthorised charging cable will invalidate your guarantee and may irreversibly damage the product.

Please charge the integral lithium battery in your Bluetooth speaker at least once a month, to prevent damage to and prolong the life of the lithium battery.

Moisture and water

- Do not leave it in low temperatures as moisture can form inside the product, which may damage the circuit board.

If you require any technical guidance or find that your product is not operating as intended, a simple solution can often be found in the **Troubleshooting**



Safety information

Important - Please read these instructions fully before installing or operating

Ventilation

- Do not block or cover slots, holes or openings on the product by placing on soft furnishings such as carpets, rugs or beds as these are provided for functionality and/or ventilation to ensure safe operation of the product.

Heat sources and flames

Do not leave it in high temperatures as electronic devices and plastic parts may warp in heat.



This page is left intentionally blank



Getting to know your Bluetooth speaker

2

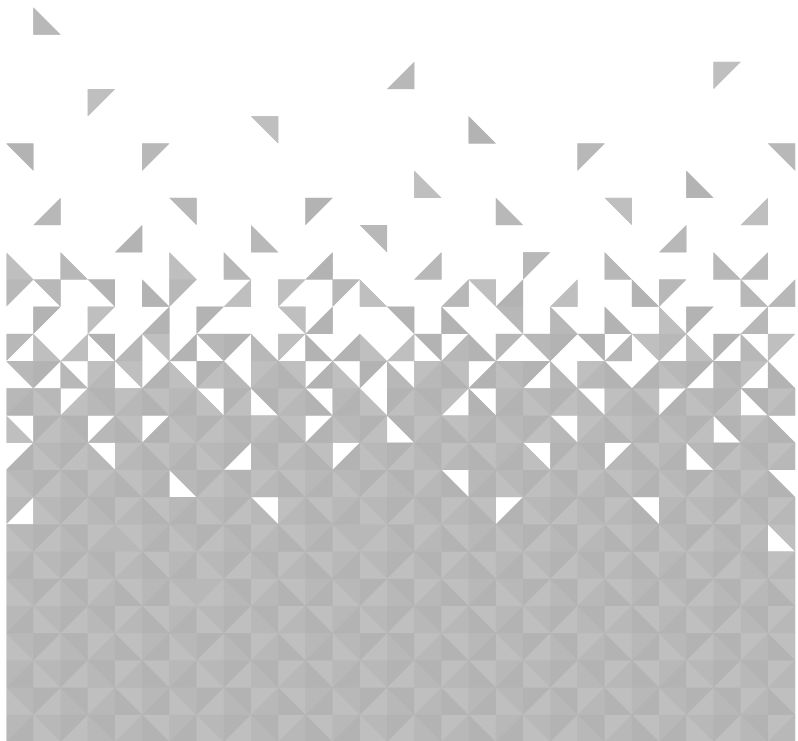

Getting to know your Bluetooth speaker

You'll be up and running in no time

Ready? Let's begin...

Please read these instructions carefully. They contain important information which will help you get the best from your product and ensure safe and correct installation and operation.

If you require any further assistance, our technical experts are happy to help. For full details, refer to the product support section at the end of these instructions.

Fig 3.

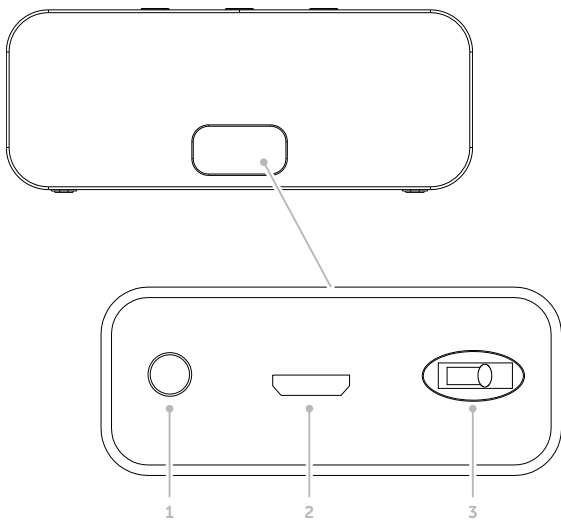

If you require any technical guidance or find that your product is not operating as intended, a simple solution can often be found in the **Troubleshooting**

Getting to know your Bluetooth speaker

You'll be up and running in no time

Fig 4.

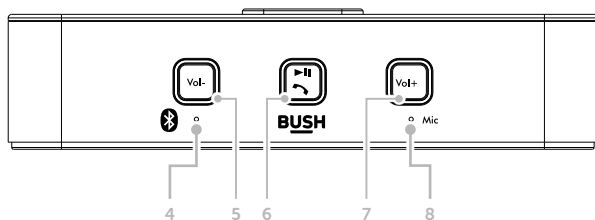

1. Aux in
2. Micro USB socket
3. On/Off switch
4. Battery charging LED (Red)/Bluetooth LED (Blue)
5. Volume -
6. Bluetooth mode:
 - Play/pauseMobile handsfree:
 - Answer/End a call
7. Volume +
8. Microphone

section of these instructions, or online at www.argos-support.co.uk if you still require further assistance, call one of our experts on 0345 600 3021.



Getting to know your Bluetooth speaker

You'll be up and running in no time

Positioning the Bluetooth speaker

It is important that you consider carefully in advance where your Bluetooth Speaker will be situated and make sure that it is:

- on a flat and stable surface.
- at least 1 metre away from other electrical appliances to avoid interference.
- where it will be in range of the connected or 'paired' bluetooth device (e.g. iPod/iPhone/iPad/Android/other phone/computer, which is about 10 metres or less (33 feet or less) in line of sight.
- Never place your Bluetooth Speaker directly onto antique or polished surfaces.

Power connection

1. Connect the micro USB end of the charging cable (supplied) to the USB socket under the rubber cover on the back of the Bluetooth speaker. Plug the standard end of the USB charging cable into a computer or other USB charging device.
2. The red battery charging LED on the top of the Bluetooth speaker will light up, to indicate that the battery is charging. When the battery is fully charged the red LED will turn off.
3. Note: It will take approximately 4 hours to fully charge your Bluetooth Speaker, before first use.
4. When fully charged, unplug the micro USB charging cable.

Note: Your Bluetooth speaker has an approximate play time of 10 hours, before it needs to be recharged. When the battery power is low, you will hear an audible alert every 5 seconds. You should plug in and recharge your Bluetooth speaker straight away.

If you require any technical guidance or find that your product is not operating as intended, a simple solution can often be found in the **Troubleshooting**





This page is left intentionally blank





This page is left intentionally blank



Using your Bluetooth speaker

3

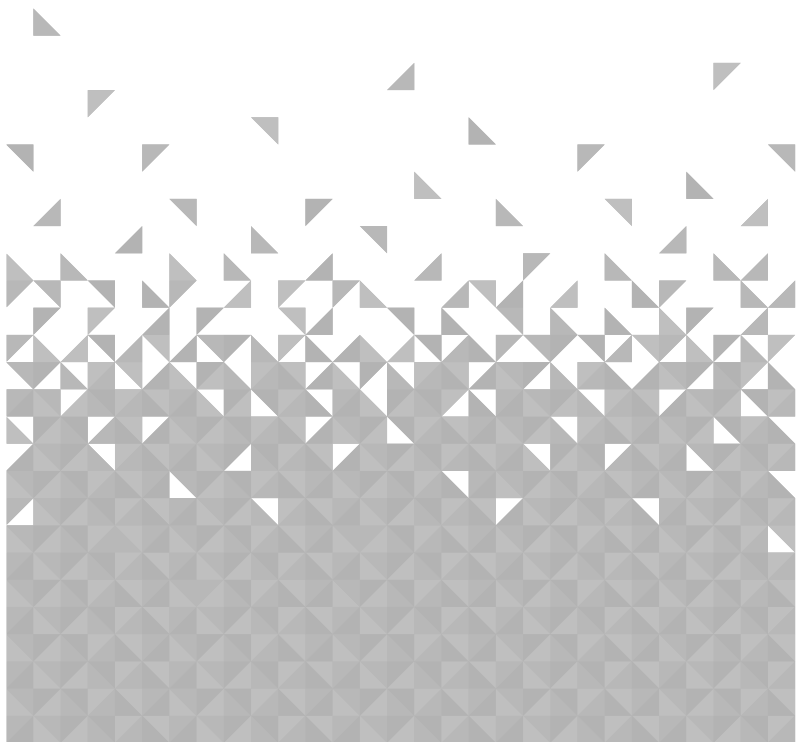



Using your Bluetooth speaker

Let's get started

Power on

Slide the Power switch under the rubber cover on the back of the product to on. Your Bluetooth speaker will switch on in Bluetooth mode. A tone will sound and the blue LED on the top of the product will flash quickly whilst your product searches for Bluetooth devices.

Standby mode

If the Bluetooth speaker does not receive an audio signal for approximately 15 minutes it will go to Standby mode and the blue Bluetooth LED will flash slowly. Press and hold the Play/Pause button to turn the product back on again. Alternatively you can slide the power switch on the back of the product to off and then on again.

Power off

Slide the Power switch under the rubber cover on the back of the product to off.

Note: You will not be able to power off your Bluetooth speaker when you are charging the battery. The red charging LED will remain on until the battery is fully charged.

Connect to a Bluetooth device

1. The blue LED on the top of the product will flash quickly whilst your product searches for Bluetooth devices.
2. On the device that you would like to connect to your Bluetooth speaker via Bluetooth (e.g. iPhone/iPad/Android/other phone/Tablet/Computer), turn on Bluetooth connectivity and ensure that it is 'discoverable'.

Note: If necessary, refer to the instructions for your device to add or set up Bluetooth.

3. Select to 'Add new device', if necessary.

Note: Some products will automatically search for a new device and so the 'Add new device' option is not available.

If you require any technical guidance or find that your product is not operating as intended, a simple solution can often be found in the [Troubleshooting](#)





Using your Bluetooth speaker

Let's get started

4. When found, your Bluetooth speaker will be displayed as 'BUSH BT870S'. Select the device name to begin pairing.

Note: If your device requests a password, please enter '0000' to complete the device pairing.

5. When pairing is complete the blue LED will change to flash slowly.
6. Now that you have paired your device with the Bluetooth speaker, it will connect to it when it is within range, which is about 10 metres or less (33 feet or less), line of sight.
7. Your device will remain paired with the Bluetooth speaker unless you decide to disconnect or 'unpair' it.

Note: You can press and hold the **▶||** button to unpair your current device and search for new devices.

Adjusting the volume

Vol-

- Press and release to decrease the volume in steps.
- Press and hold to progressively decrease the volume.

Vol+

- Press and release to increase the volume in steps.
- Press and hold to progressively increase the volume.

Note: You will hear an audible alert when the minimum or maximum volume level has been reached.

section of these instructions, or online at www.argos-support.co.uk if you still require further assistance, call one of our experts on 0345 600 3021.





Using your Bluetooth speaker

Let's get started

Listening to Music/Audio using Bluetooth

In Bluetooth mode:

1. Select and start the music or audio that you wish to listen to on your paired Bluetooth device, it will now be heard through the Bluetooth speaker. Adjust the volume on the connected device and/or your Bluetooth speaker
2. You can use the controls on your paired Bluetooth device as well as those on your Bluetooth speaker.
 - Play/Pause: ▶|| Press and release to play/pause.

Using as a Mobile handsfree speakerphone



If your mobile phone supports the Hands Free Profile (HFP) or Headset Profile (HSP) you can pair it with your Bluetooth speaker and use it as a handsfree speaker when it is in Bluetooth mode. Follow the steps on page xx to pair your mobile phone with the Bluetooth speaker.

Note: If your mobile supports both the HFP and HSP profiles, set it to HFP.

Make an outgoing call:

1. Dial the number as usual on your mobile phone, you will be able to hear the progress of the call and your caller through your Bluetooth speaker and your caller will also be able to hear you.
2. Press and release the  button on the Bluetooth speaker to end the call, or end the call as usual on your mobile phone.

Receive an incoming call:

1. Press and release the  button on your Bluetooth speaker or answer the call as usual on your mobile phone. You will be able to hear your caller through your Bluetooth speaker and your caller will also be able to hear you.
2. Press and release the  button on the Bluetooth speaker to end the call, or end the call as usual on your mobile phone.

If you require any technical guidance or find that your product is not operating as intended, a simple solution can often be found in the **Troubleshooting**



Using your Bluetooth speaker

Let's get started

Note: If you were listening to music when you receive or make a call, the music will be paused whilst the call is in progress and will resume once the call ends.

Aux in mode

1. Connect one end of a 3.5mm audio cable (not supplied) to the headphone (or auxiliary out) socket of your secondary device. Connect the other end to the Aux in socket under the rubber cover on the back of your Bluetooth speaker. This will switch your bluetooth speaker to Aux in mode.
2. Press the Play button on your external device to start playback through the Bluetooth speaker.
3. To gain optimal volume levels, adjust the volume level on both the secondary device and on the Bluetooth speaker.

Note: After you have finished listening to your external device you must unplug the audio cable from the Aux in socket, to be able to use it as a Bluetooth speaker again.



This page is left intentionally blank





Other information

4

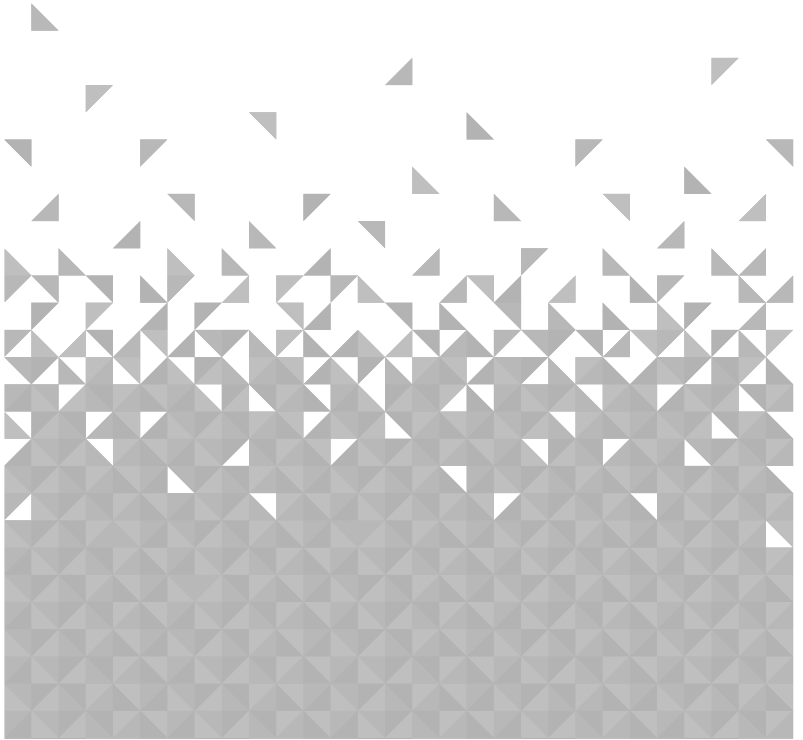

Other information

Helpful technical information

Technical specification

Audio output:	2 x 2W RMS
Micro USB socket:	Input DC 5V 1A
Lithium battery:	2000 mAh
Bluetooth:	Version 2.1 + EDR
Pairing name:	BUSH BT870S
Profiles:	HFPV1.5, A2DPV1.2, AVRCPV1.4, GAVDP1.2, IOP
Frequency range:	2.400GHz-2.480GHz

This product is intended for use within the UK. This equipment complies with the essential requirements of the Radio Equipment Directive 2014/53/EU.

Declaration of Conformance

Hereby, Argos Ltd, declares that this Band II LPD device is in compliance with the essential requirements and other relevant provisions of the Radio Equipment Directive 2014/53/EU. The complete declaration of conformity can be obtained by contacting <http://www.argos-support.co.uk/>

If you require any technical guidance or find that your product is not operating as intended, a simple solution can often be found in the **Troubleshooting**



This page is left intentionally blank







This page is left intentionally blank

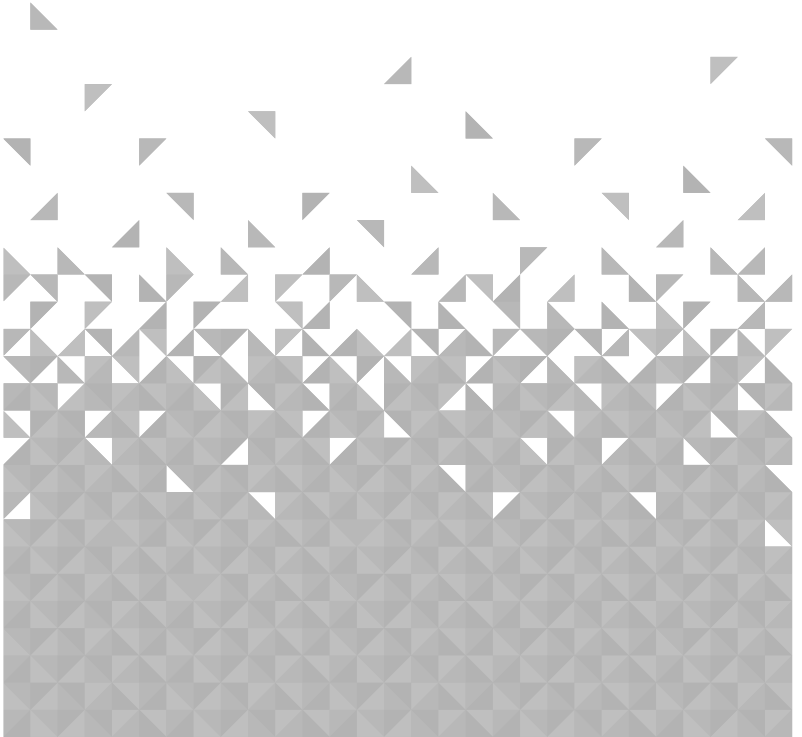

Product support

5





Product support

Help is always at hand

Troubleshooting

Unable to pair with a Bluetooth device:

- Check that you are in Bluetooth mode.
- Ensure that you are within range of the Bluetooth speaker for Bluetooth functionality, 10 metres or less (33 feet or less).
- Check that the device you are attempting to pair with supports A2DP stereo audio transmission.
- Move the Bluetooth speaker and Bluetooth device away from other Bluetooth devices/electrical equipment.
- If possible, turn off other nearby Bluetooth devices or disable their Bluetooth functionality.



No sound / Sound distortion:



- Adjust the volume
- If you are using a Bluetooth connected device, check the volume on the secondary device and on your Bluetooth speaker
- Your Bluetooth speaker may need to be recharged. Please check the small white battery charge status lights on the left hand side of your Bluetooth speaker and recharge if necessary.

If you require any technical guidance or find that your product is not operating as intended, a simple solution can often be found in the **Troubleshooting**

Product support

Help is always at hand

Help and assistance

If you require any technical guidance or find that your Bluetooth speaker is not operating as intended, a simple solution can often be found in the **Troubleshooting** section of these instructions or online at www.argos-support.co.uk

If you still require further assistance, call one of our experts on **0345 600 3021***. To help give us give you a fast and efficient service please have the following information ready:

Model Ref.

Serial number

You can find these on the rating plate - a small information panel (usually a sticker or metal plate) on the rear of your product.

Date of purchase

This will be shown on your receipt

Local call rates applies*

Lines open 8am-7pm Monday to Saturday and
10am-4pm Sunday.

*Calls to Argos enquiry lines may attract a charge and set up fee from residential lines depending on your call plan/tariff. Mobile and other providers costs may vary, see www.bt.com/pricing for details.

For security and training purposes, telephone calls to and from customer service centres may be recorded and monitored. Calls from Republic of Ireland will attract international call charges.

section of these instructions, or online at www.argos-support.co.uk If you still require further assistance, call one of our experts on 0345 600 3021.

Product support

Help is always at hand

Disposal



- This product should not be treated as normal household waste and it should be recycled. Please take it to your nearest collection facility or for further details contact your local council or visit www.recycle-more.co.uk
- Batteries contain substances that may be harmful to the environment and human health. Keep out of the reach of children and seek immediate medical help if swallowed.
- Batteries should not be disposed of in the normal household waste but taken to appropriate local recycling facilities, where and when these are available.
- Never throw batteries in a fire or attempt to open the outer casing.

If you require any technical guidance or find that your product is not operating as intended, a simple solution can often be found in the **Troubleshooting**



Product support

Help is always at hand

BUSH

Call us now and activate your 12 month guarantee

Thank you for choosing Bush. Your new product is guaranteed against faults and breakdowns for 12 months. Don't forget to register it with us today so we can provide you with our best possible after-sales service and useful updates.

www.bushregistration.co.uk

FREEPHONE*

0800 597 8548

Lines are open 8am - 8pm, 365 days a year. *Calls may be recorded and monitored.

Your Bush Guarantee

This product is guaranteed for twelve months from the date of original purchase. Any defect that arises due to faulty materials or workmanship will be repaired free of charge (or if applicable the product will be replaced or the purchase price refunded) where possible during this period by the dealer from who your purchased the unit.

The guarantee is subject to the following provisions:

- The guarantee does not cover accidental damage, misuse, cabinet parts, knobs or consumable items.
- The product must be correctly installed and operated in accordance with the instructions contained in the manual.
- It must be used solely for domestic purposes. The guarantee will be rendered invalid if the product is re-sold or has been damaged by inexpert repair.
- Specifications are subject to change without notice.
- Bush disclaim any liability for loss or damage arising from the breakdown of the product.
- This guarantee is in addition to and does not diminish your statutory or legal rights.

Important Data Protection Information

If you provide us with information about another person, you confirm that they have appointed you to act for them, to consent to the processing of their personal data including sensitive personal data and that you have informed them of our identity and the purposes (as set out in the Important Data Privacy notice displayed overleaf) for which their personal data will be processed.

You are entitled to ask for a copy of the information we hold about you (for which we may charge a small fee) and to have any inaccuracies in your information corrected.

For quality control and training purposes, we may monitor or record your communications with us.

If your personal details change, if you change your mind about any of your marketing preferences or if you have any queries about how we use your information, please let us know by contacting our Data Protection Officer, Domestic & General, Leicester House 17 Leicester Street, Bedworth, Warwickshire CV12 8JP.

Guarantor: Argos Limited - 489 - 499 Avebury Blvd. - Milton Keynes - MK9 2NW

section of these instructions, or online at www.argos-support.co.uk if you still require further assistance, call one of our experts on 0345 600 3021.





This page is left intentionally blank





This page is left intentionally blank



BUSH

Contact:

www.argos-support.co.uk

Helpline: 0345 600 3021