

IXUS 185 Camera User Guide

ENGLISH

- Make sure you read this guide, including the “Safety Instructions” (📖7) section, before using the camera.
- Reading this guide will help you learn to use the camera properly.
- Store this guide safely so that you can use it in the future.
- Click the buttons in the lower right to access other pages.
 - ▶: Next page
 - ◀: Previous page
 - 🔗: Page before you clicked a link
- To jump to the beginning of a chapter, click the chapter title at right.
From chapter title pages, you can access topics by clicking their titles.

Before Use

Basic Guide

Advanced Guide

Camera Basics

Auto Mode

Other Shooting Modes

P Mode

Playback Mode

Setting Menu

Accessories

Appendix

Index



Package Contents

Before use, make sure the following items are included in the package. If anything is missing, contact your camera retailer.



Camera



Battery Pack
NB-11L*

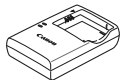

Battery Charger
CB-2LF/CB-2LFE



Wrist Strap

Printed Matter

* Do not peel off the adhesive covering from a battery pack.

- A memory card is not included (📖2).

Compatible Memory Cards

The following memory cards (sold separately) can be used, regardless of capacity.

- SD memory cards*
- SDHC memory cards*
- SDXC memory cards* 
- FlashAir cards
- Eye-Fi cards

* Cards conforming to SD standards. However, not all memory cards have been verified to work with the camera.

Eye-Fi/FlashAir Cards

This product is not guaranteed to fully support functions of Eye-Fi/FlashAir cards (including wireless transfer). In case of any card related issues, please check with the card manufacturer. Also note that approval is required to use Eye-Fi/FlashAir cards in many countries or regions. Without approval, the use of Eye-Fi/FlashAir cards is not permitted.

If it is unclear whether your card is approved for use in your area, please check with the card manufacturer.

Availability of Eye-Fi/FlashAir cards also varies by region.

Before Use

Basic Guide

Advanced Guide

Camera Basics

Auto Mode

Other Shooting Modes

P Mode

Playback Mode

Setting Menu

Accessories

Appendix

Index



Preliminary Notes and Legal Information

- Take and review some test shots initially to make sure the images were recorded correctly. Please note that Canon Inc., its subsidiaries and affiliates, and its distributors are not liable for any consequential damages arising from any malfunction of a camera or accessory, including memory cards, that result in the failure of an image to be recorded or to be recorded in a way that is machine readable.
- The user's unauthorized photographing or recording (video and/or sound) of people or copyrighted materials may invade the privacy of such people and/or may violate others' legal rights, including copyright and other intellectual property rights, even when such photographing or recording is intended solely for personal use.
- For information on camera warranty or Canon Customer Support, please refer to the warranty information provided with your camera User Manual Kit.
- Although the screen (monitor) is produced under extremely high-precision manufacturing conditions and more than 99.99% of the pixels meet design specifications, in rare cases some pixels may be defective or may appear as red or black dots. This does not indicate camera damage or affect recorded images.
- When the camera is used over an extended period, it may become warm. This does not indicate damage.

Before Use

Basic Guide

Advanced Guide

Camera Basics

Auto Mode

Other Shooting Modes

P Mode

Playback Mode

Setting Menu

Accessories

Appendix

Index



Part Names and Conventions in This Guide

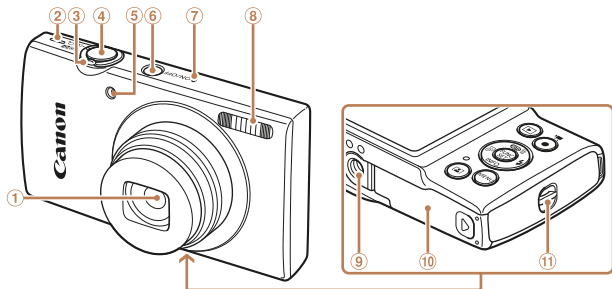

- | | |
|--|-----------------------------|
| ① Lens | ⑤ Lamp |
| ② Speaker | ⑥ ON/OFF button |
| ③ Zoom lever | ⑦ Microphone |
| Shooting: (telephoto) / (wide angle) | ⑧ Flash |
| Playback: (magnify) / (index) | ⑨ Tripod socket |
| ④ Shutter button | ⑩ Memory card/battery cover |
| | ⑪ Strap mount |

- Shooting modes and on-screen icons and text are indicated in brackets.
- ⓘ: Important information you should know
- 📌: Notes and tips for expert camera use
- 📖xx: Pages with related information (in this example, “xx” represents a page number)
- The tabs shown above titles indicate whether the function is used for still images, movies, or both.

Still Images : Indicates that the function is used when shooting or viewing still images.

Movies : Indicates that the function is used when shooting or viewing movies.

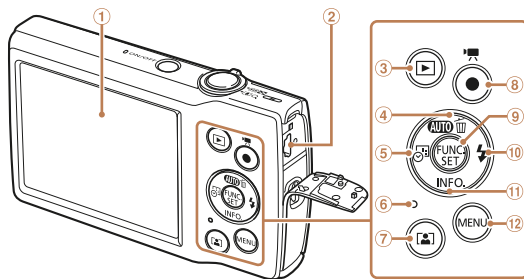

- | | |
|--|---------------------------------|
| ① Screen (monitor) | ⑧ Movie button |
| ② AV OUT (Audio/video output) / DIGITAL terminal | ⑨ FUNC. (Function) / SET button |
| ③ (Playback) button | ⑩ (Flash) / Right button |
| ④ (Auto) / (Single-image erase) / Up button | ⑪ (Information) / Down button |
| ⑤ (Date stamp) / Left button | ⑫ (MENU) button |
| ⑥ Indicator | |
| ⑦ (Auto zoom) button | |

- In this guide, icons are used to represent the corresponding camera buttons on which they appear, or which they resemble.
- The following camera buttons and controls are represented by icons.

	Up button ④ on back		Right button ⑩ on back
	Left button ⑤ on back		Down button ⑪ on back
- Instructions in this guide apply to the camera under default settings.
- For convenience, all supported memory cards are simply referred to as the “memory card”.

Before Use

Basic Guide

Advanced Guide

Camera Basics

Auto Mode

Other Shooting Modes

P Mode

Playback Mode

Setting Menu

Accessories

Appendix

Index



Table of Contents

Package Contents	2	Auto Mode	26
Compatible Memory Cards	2	Shooting with Camera-Determined Settings	27
Preliminary Notes and Legal Information	3	Common, Convenient Features	31
Part Names and Conventions in This Guide	4	Image Customization Features	36
Table of Contents	5	Customizing Camera Operation	37
Common Camera Operations	6	Other Shooting Modes	38
Safety Instructions	7	Specific Scenes	39
Basic Guide	10	Applying Special Effects	40
Initial Preparations	11	Special Modes for Other Purposes	43
Trying the Camera Out	16	P Mode	45
Advanced Guide	20	Shooting in Program AE ([P] Mode)	46
Camera Basics	20	Image Brightness (Exposure)	46
On/Off	21	Adjusting White Balance	48
Shutter Button	22	Shooting Range and Focusing	49
Shooting Display Options	22	Flash	53
Using the FUNC. Menu	23	Other Settings	54
Using the Menu Screen	24		
Indicator Display	25		

Playback Mode	56
Viewing	57
Browsing and Filtering Images	58
Image Viewing Options	60
Protecting Images	61
Erasing Images	64
Rotating Images	66
Editing Still Images	67
Setting Menu	69
Adjusting Basic Camera Functions	70
Accessories	77
System Map	78
Optional Accessories	79
Using Optional Accessories	80
Using the Software	81
Printing Images	84
Using an Eye-Fi/FlashAir Card	92
Appendix	94
Troubleshooting	95
On-Screen Messages	97
On-Screen Information	99
Functions and Menu Tables	101
Handling Precautions	107
Specifications	107
Index	111

Before Use

Basic Guide

Advanced Guide

Camera Basics

Auto Mode

Other Shooting Modes

P Mode

Playback Mode

Setting Menu

Accessories

Appendix

Index



Common Camera Operations

Shoot

- Use camera-determined settings (Auto Mode) 27

Shooting people well



Portraits
(39)

Matching specific scenes



Low Light
(39)



Fireworks
(39)

Applying special effects



Vivid Colors
(40)



Poster Effect
(40)



Fish-Eye Effect
(41)



Miniature Effect
(41)



Toy Camera Effect
(42)



Monochrome
(43)

- Focus on faces..... 27, 39, 50
- Without using the flash (Flash Off)..... 35, 53
- Include yourself in the shot (Self-Timer) 33, 43
- Add a date stamp..... 32

View

- View images (Playback Mode)..... 57
- Automatic playback (Slideshow) 60
- On a TV..... 80
- On a computer 81
- Browse through images quickly 58
- Erase images 64

Record/View Movies

- Record movies 27
- View movies (Playback Mode)..... 57

Print

- Print pictures 84

Save

- Save images to a computer 82

Before Use

Basic Guide

Advanced Guide

Camera Basics

Auto Mode

Other Shooting Modes

P Mode

Playback Mode

Setting Menu

Accessories

Appendix

Index



Safety Instructions

- Be sure to read these instructions in order to operate the product safely.
- Follow these instructions to prevent injury or harm to the operator of the product or others.



WARNING

Denotes the risk of serious injury or death.

- **Keep the product out of the reach of young children.**

A strap wrapped around a person's neck may result in strangulation.

The accessory shoe cover is dangerous if swallowed. If swallowed, seek immediate medical assistance.

- **Use only power sources specified in this instruction manual for use with the product.**
- **Do not disassemble or modify the product.**
- **Do not expose the product to strong shocks or vibration.**
- **Do not touch any exposed internal parts.**
- **Stop using the product in any case of unusual circumstances such as the presence of smoke or a strange smell.**
- **Do not use organic solvents such as alcohol, benzene or paint thinner to clean the product.**
- **Do not get the product wet. Do not insert foreign objects or liquids into the product.**
- **Do not use the product where flammable gases may be present.**

This may cause electric shock, explosion or fire.

- **For products featuring a viewfinder, do not look through the viewfinder at strong light sources such as the sun on a bright day or lasers and other strong artificial light sources.**

This may harm your vision.

- **Observe the following instructions when using commercially available batteries or provided battery packs.**
 - **Use batteries/battery packs only with their specified product.**
 - **Do not heat batteries/battery packs or expose them to fire.**
 - **Do not charge batteries/battery packs using non-authorized battery chargers.**
 - **Do not expose the terminals to dirt or let them come into contact with metallic pins or other metal objects.**
 - **Do not use leaking batteries/battery packs.**
 - **When disposing of batteries/battery packs, insulate the terminals with tape or other means.**

This may cause electric shock, explosion or fire.

If a battery/battery pack leaks and the material contacts your skin or clothing, flush the exposed area thoroughly with running water. In case of eye contact, flush thoroughly with copious amounts of clean running water and seek immediate medical assistance.

Before Use

Basic Guide

Advanced Guide

Camera Basics

Auto Mode

Other Shooting Modes

P Mode

Playback Mode

Setting Menu

Accessories

Appendix

Index



- Observe the following instructions when using a battery charger.
- Observe the following instructions when using a battery charger or AC adapter.
 - Periodically remove any dust buildup from the power plug and power outlet using a dry cloth.
 - Do not plug in or unplug the product with wet hands.
 - Do not use the product if the power plug is not fully inserted into the power outlet.
 - Do not expose the power plug and terminals to dirt or let them come into contact with metallic pins or other metal objects.
 - Do not touch the battery charger or AC adapter connected to a power outlet during lightning storms.
 - Do not place heavy objects on the power cord. Do not damage, break or modify the power cord.
 - Do not wrap the product in cloth or other materials when in use or shortly after use when the product is still warm in temperature.
 - Do not leave the product connected to a power source for long periods of time.

This may cause electric shock, explosion or fire.

- **Do not allow the product to maintain contact with the same area of skin for extended periods of time during use.**

This may result in low-temperature contact burns, including skin redness and blistering, even if the product does not feel hot. The use of a tripod or similar equipment is recommended when using the product in hot places and for people with circulation problems or less sensitive skin.

- **Follow any indications to turn off the product in places where its use is forbidden.**

Not doing so may cause other equipment to malfunction due to the effect of electromagnetic waves and even result in accidents.

CAUTION

Denotes the risk of injury.

- **Do not fire the flash near the eyes.**

It may hurt the eyes.

- **Strap is intended for use on the body only. Hanging the strap with any product attached on a hook or other object may damage the product. Also, do not shake the product or expose the product to strong impacts.**
- **Do not apply strong pressure on the lens or allow an object to hit it.**

This may cause injury or damage to the product.

- **Flash emits high temperatures when fired. Keep fingers, any other part of your body, and objects away from the flash unit while taking pictures.**

This may cause burns or malfunction of the flash.

- **Do not leave the product in places exposed to extremely high or low temperatures.**

The product may become extremely hot/cold and cause burns or injury when touched.

Caution

Denotes the possibility of property damage.

- **Do not aim the camera at intense light sources, such as the sun on a clear day or an intense artificial light source.**

Doing so may damage the image sensor or other internal components.

- **When using the camera on a sandy beach or at a windy location, be careful not to allow dust or sand to enter the camera.**

- **Wipe off any dust, grime, or other foreign matter on the flash with a cotton swab or cloth.**

The heat emitted from the flash may cause foreign matter to smoke or the product to malfunction.

Before Use

Basic Guide

Advanced Guide

Camera Basics

Auto Mode

Other Shooting Modes

P Mode

Playback Mode

Setting Menu

Accessories

Appendix

Index



- **Remove and store the battery pack/batteries when you are not using the product.**

Any battery leakage that occurs may cause product damage.

- **Before you discard the battery pack/batteries, cover the terminals with tape or other insulators.**

Contacting other metal materials may lead to fire or explosions.

- **Unplug any battery charger used with the product when not in use. Do not cover with a cloth or other objects when in use.**

Leaving the unit plugged in for a long period of time may cause it to overheat and distort, resulting in fire.

- **Do not leave any dedicated battery packs near pets.**

Pets biting the battery pack could cause leakage, overheating, or explosion, resulting in product damage or fire.

- **If your product uses multiple batteries, do not use batteries that have different levels of charge together, and do not use old and new batteries together. Do not insert the batteries with the + and – terminals reversed.**

This may cause the product to malfunction.

- **Do not sit down with the camera in your pant pocket.**

Doing so may cause malfunctions or damage the screen.

- **When putting the camera in your bag, ensure that hard objects do not come into contact with the screen. Also close the screen (so that it faces the body), if your product's screen closes.**

- **Do not attach any hard objects to the product.**

Doing so may cause malfunctions or damage the screen.



Before Use

Basic Guide

Advanced Guide

Camera Basics

Auto Mode

Other Shooting Modes

P Mode

Playback Mode

Setting Menu

Accessories

Appendix

Index



Basic Guide

Basic information and instructions, from initial preparations to shooting and playback

Initial Preparations	11	Trying the Camera Out	16
Attaching the Strap.....	11	Shooting.....	16
Holding the Camera.....	11	Viewing.....	18
Charging the Battery Pack.....	11		
Inserting the Battery Pack and Memory Card.....	12		
Setting the Date and Time.....	13		
Display Language.....	15		

Before Use

Basic Guide

Advanced Guide

Camera Basics

Auto Mode

Other Shooting Modes

P Mode

Playback Mode

Setting Menu

Accessories

Appendix

Index



Initial Preparations

Prepare for shooting as follows.

Attaching the Strap

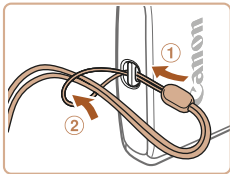

- Thread the end of the strap through the strap mount (①), and then pull the other end of the strap through the loop on the threaded end (②).

Holding the Camera

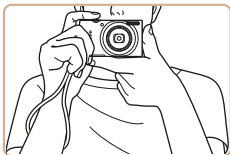

- Place the strap around your wrist.
- When shooting, keep your arms close to your body and hold the camera securely to prevent it from moving. Do not rest your fingers on the flash.

Charging the Battery Pack

Before use, charge the battery pack with the included charger. Be sure to charge the battery pack initially, because the camera is not sold with the battery pack charged.

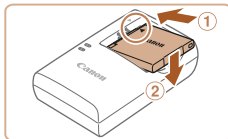

1 Insert the battery pack.

- After aligning the ▲ marks on the battery pack and charger, insert the battery pack by pushing it in (①) and down (②).

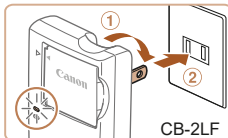

2 Charge the battery pack.

- CB-2LF: Flip out the plug (①) and plug the charger into a power outlet (②).
- CB-2LFE: Plug the power cord into the charger, then plug the other end into a power outlet.
- The charging lamp turns orange, and charging begins.
- When charging is finished, the lamp turns green.

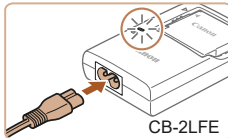

3 Remove the battery pack.

- After unplugging the battery charger, remove the battery pack by pushing it in (①) and up (②).

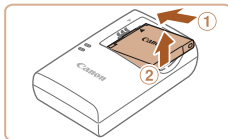

Before Use

Basic Guide

Advanced Guide

Camera Basics

Auto Mode

Other Shooting Modes

P Mode

Playback Mode

Setting Menu

Accessories

Appendix

Index





- To protect the battery pack and keep it in optimal condition, do not charge it continuously for more than 24 hours.
- For battery chargers that use a power cord, do not attach the charger or cord to other objects. Doing so could result in malfunction or damage to the product.



- For details on charging time and the number of shots and recording time possible with a fully charged battery pack, see "Power" (109).
- Charged battery packs gradually lose their charge, even when they are not used. Charge the battery pack on (or immediately before) the day of use.
- The charger can be used in areas with 100 – 240 V AC power (50/60 Hz). For power outlets in a different format, use a commercially available adapter for the plug. Never use an electrical transformer designed for traveling, which may damage the battery pack.

Inserting the Battery Pack and Memory Card

Insert the included battery pack and a memory card (sold separately). Note that before using a memory card that is new or has been formatted in another device, you should format the memory card with this camera (73).

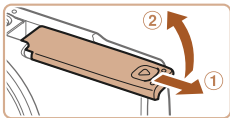

1 Open the cover.

- Slide the cover (1) and open it (2).

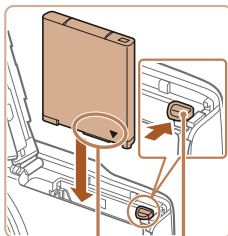

Terminals
Battery Lock

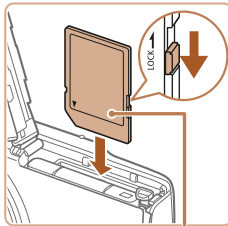

Label

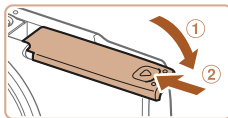

2 Insert the battery pack.

- While pressing the battery lock in the direction of the arrow, insert the battery pack as shown and push it in until it clicks into the locked position.

3 Check your card's write-protect switch and insert the memory card.

- Recording is not possible on memory cards with a write-protect switch when the switch is in the locked position. Slide the switch to the unlocked position.
- Insert the memory card facing as shown until it clicks into the locked position.
- Make sure the memory card is facing the right way when you insert it. Inserting memory cards facing the wrong way may damage the camera.

4 Close the cover.

- Lower the cover (1) and hold it down as you slide it, until it clicks into the closed position (2).
- If the cover will not close, make sure you inserted the battery pack facing the right way in step 2.

Before Use

Basic Guide

Advanced Guide

Camera Basics

Auto Mode

Other Shooting Modes

P Mode

Playback Mode

Setting Menu

Accessories

Appendix

Index





- For guidelines on how many shots or hours of recording can be saved on one memory card, see "Recording" (📖108).

■ Removing the Battery Pack and Memory Card

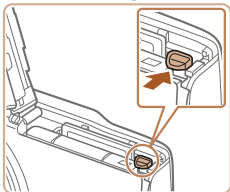

Remove the battery pack.

- Open the cover and press the battery lock in the direction of the arrow.
- The battery pack will pop up.

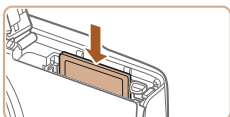

Remove the memory card.

- Push the memory card in until it clicks, and then slowly release it.
- The memory card will pop up.

■ Setting the Date and Time

Set the current date and time correctly as follows if the [Date/Time] screen is displayed when you turn the camera on. Information you specify this way is recorded in image properties when you shoot, and it is used when you manage images by shooting date or print images showing the date. You can also add a date stamp to shots, if you wish (📖32).



1 Turn the camera on.

- Press the ON/OFF button.
- The [Date/Time] screen is displayed.

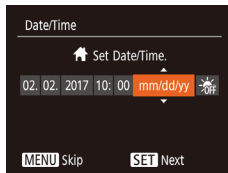

2 Set the date and time.

- Press the [◀][▶] buttons to choose an item.
- Press the [▲][▼] buttons to specify the date and time.
- When finished, press the [⊙] button.



Before Use

Basic Guide

Advanced Guide

Camera Basics

Auto Mode

Other Shooting Modes

P Mode

Playback Mode

Setting Menu

Accessories

Appendix

Index



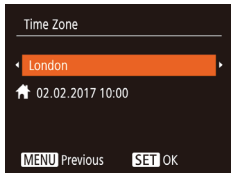

3 Specify your home time zone.

- Press the [◀][▶] buttons to choose your home time zone.

4 Finish the setup process.

- Press the [FUNC SET] button to complete the setting. The setting screen is no longer displayed.
- To turn off the camera, press the ON/OFF button.



- Unless you set the date, time, and home time zone, the [Date/Time] screen will be displayed each time you turn the camera on. Specify the correct information.



- To set daylight saving time (1 hour ahead), choose [☀] in step 2 and then choose [☀] by pressing the [▲][▼] buttons.

Changing the Date and Time

Adjust the date and time as follows.

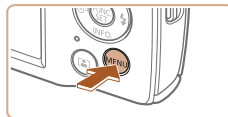

1 Enter Playback mode.

- Press the [▶] button.

2 Access the menu screen.

- Press the [MENU] button.

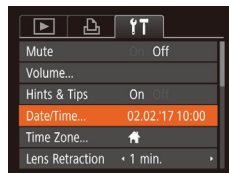

3 Choose [Date/Time].

- Move the zoom lever to choose the [↑] tab.
- Press the [▲][▼] buttons to choose [Date/Time], and then press the [FUNC SET] button.

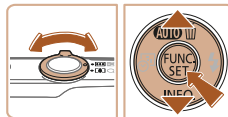

Before Use

Basic Guide

Advanced Guide

Camera Basics

Auto Mode

Other Shooting Modes

P Mode

Playback Mode

Setting Menu

Accessories

Appendix

Index



4 Change the date and time.

- Follow step 2 in “Setting the Date and Time” (📖 13) to adjust the settings.
- Press the [MENU] button to close the menu screen.



- Date/time settings can be retained for about 3 weeks by the camera's built-in date/time battery (backup battery) after the battery pack is removed.
- The date/time battery will be charged in about 4 hours once you insert a charged battery pack, even if the camera is left off.
- Once the date/time battery is depleted, the [Date/Time] screen will be displayed when you turn the camera on. Set the correct date and time as described in “Setting the Date and Time” (📖 13).

Display Language

Change the display language as needed.



1 Enter Playback mode.

- Press the [▶] button.

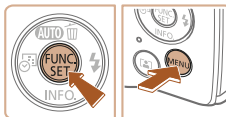

2 Access the setting screen.

- Press and hold the [ⓘ] button, and then press the [MENU] button.

English	Norsk	Română
Deutsch	Svenska	Türkçe
Français	Español	العربية
Nederlands	Ελληνικά	ภาษาไทย
Dansk	Русский	简体中文
Português	Polski	繁體中文
Suomi	Čeština	한국어

3 Set the display language.

- Press the [▲][▼][◀][▶] buttons to choose a language, and then press the [ⓘ] button.
- Once the display language has been set, the setting screen is no longer displayed.



- You can also change the display language by pressing the [MENU] button and choosing [Language] (🗨️) on the [🔧] tab.

Before Use

Basic Guide

Advanced Guide

Camera Basics

Auto Mode

Other Shooting Modes

P Mode

Playback Mode

Setting Menu

Accessories

Appendix

Index



Trying the Camera Out

Try out the camera by turning it on, shooting some still images or movies, and viewing them.

Shooting

For fully automatic selection of the optimal settings for specific scenes, simply let the camera determine the subject and shooting conditions. Note that initially, the FUNC./SET button and some others are disabled to prevent mistakes as you learn how to use the camera (Easy Auto).

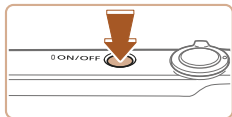

1 Turn the camera on.

- Press the ON/OFF button.
- The startup screen is displayed.



2 Aim the camera at the subject.

- Aim the camera at the subject. The camera will make a slight clicking noise as it determines the scene.
- A scene icon is displayed in the upper right of the screen.
- Frames displayed around any detected subjects indicate that they are in focus.



3 Compose the shot.

- To zoom in and enlarge the subject, move the zoom lever toward **[T]** (telephoto), and to zoom away from the subject, move it toward **[W]** (wide angle).

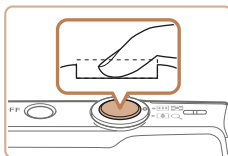
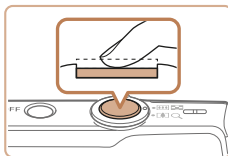

4 Shoot. Shooting Still Images

① Focus.

- Press the shutter button lightly, halfway down. The camera beeps twice after focusing, and AF frames are displayed to indicate image areas in focus.

② Shoot.

- Press the shutter button all the way down.
- As the camera shoots, a shutter sound is played, and in low-light conditions, the flash fires automatically.
- Keep the camera still until the shutter sound ends.
- After displaying your shot, the camera will revert to the shooting screen.





Shooting Time



Recording Movies

① Start recording.

- Press the movie button. The camera beeps once as recording begins, and [●Rec] is displayed with the elapsed time.
- Black bars displayed on the top and bottom edges of the screen indicate image areas not recorded.
- Frames displayed around any detected faces indicate that they are in focus.
- Once recording begins, take your finger off the movie button.

② Finish recording.

- Press the movie button again to stop recording. The camera beeps twice as recording stops.

Disabling Easy Auto

Once you are finished using Easy Auto, you can try configuring common, convenient features (📖31), as by pressing the FUNC./SET button.

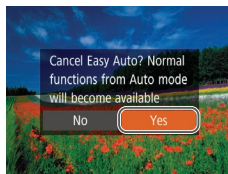

- Press and hold the [▲] button.
- Press the [◀][▶] buttons to choose [Yes], and then press the [⊙] button.
- You can return to Easy Auto mode by pressing and holding the [▲] button to display the setting screen and then choosing [Yes].

Before Use

Basic Guide

Advanced Guide

Camera Basics

Auto Mode

Other Shooting Modes

P Mode

Playback Mode

Setting Menu

Accessories

Appendix

Index



Viewing

After shooting images or movies, you can view them on the screen as follows.



1 Enter Playback mode.

- Press the [▶] button.
- Your last shot is displayed.



2 Choose images.

- To view the previous image, press the [◀] button. To view the next image, press the [▶] button.
- Press and hold the [◀][▶] buttons to browse through images quickly.



- Movies are identified by a [SET ▶] icon. To play movies, go to step 3.

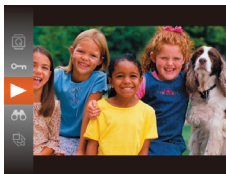

3 Play movies.

- Press the [FUNC/SET] button, press the [▲][▼] buttons to choose [▶], and then press the [FUNC/SET] button again.
- Playback now begins, and after the movie is finished, [SET ▶] is displayed.
- To adjust the volume, press the [▲][▼] buttons during playback.



- To switch to Shooting mode from Playback mode, press the shutter button halfway.

Before Use

Basic Guide

Advanced Guide

Camera Basics

Auto Mode

Other Shooting Modes

P Mode

Playback Mode

Setting Menu

Accessories

Appendix

Index



Erasing Images

You can choose and erase unneeded images one by one. Be careful when erasing images, because they cannot be recovered.

1 Choose an image to erase.

- Press the [◀][▶] buttons to choose an image.

2 Erase the image.

- Press the [▲] button.
- After [Erase?] is displayed, press the [◀][▶] buttons to choose [Erase], and then press the [OK] button.
- The current image is now erased.
- To cancel erasure, press the [◀][▶] buttons to choose [Cancel], and then press the [OK] button.



- You can choose multiple images to erase at once (p.64).

Before Use

Basic Guide

Advanced Guide

Camera Basics

Auto Mode

Other Shooting Modes

P Mode

Playback Mode

Setting Menu

Accessories

Appendix

Index



Camera Basics

Other basic operations and more ways to enjoy your camera, including shooting and playback options

On/Off	21	Using the FUNC. Menu	23
Power-Saving Features (Auto Power Down)	21	Using the Menu Screen	24
Shutter Button	22	Indicator Display	25
Shooting Display Options	22		

Before Use

Basic Guide

Advanced Guide

Camera Basics

Auto Mode

Other Shooting Modes

P Mode

Playback Mode

Setting Menu

Accessories

Appendix

Index



On/Off

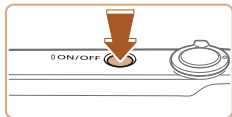



Shooting Mode



- Press the ON/OFF button to turn the camera on and prepare for shooting.
- To turn the camera off, press the ON/OFF button again.



Playback Mode

- Press the  button to turn the camera on and view your shots.
- To turn the camera off, press the  button again.



- To switch to Playback mode from Shooting mode, press the  button.
- To switch to Shooting mode from Playback mode, press the shutter button halfway ([82](#)).
- The lens will be retracted after about one minute once the camera is in Playback mode. You can turn the camera off when the lens is retracted by pressing the  button.

Power-Saving Features (Auto Power Down)

As a way to conserve battery power, the camera automatically deactivates the screen (Display Off) and then turns itself off after a specific period of inactivity.

Power Saving in Shooting Mode

The screen is automatically deactivated after about one minute of inactivity. In about two more minutes, the lens is retracted and the camera turns itself off. To activate the screen and prepare for shooting when the screen is off but the lens is still out, press the shutter button halfway ([82](#)).

Power Saving in Playback Mode

The camera turns itself off automatically after about five minutes of inactivity.



- You can deactivate Auto Power Down and adjust the timing of Display Off, if you prefer ([72](#)).
- Power saving is not active while the camera is connected to a computer ([82](#)).

Before Use

Basic Guide

Advanced Guide

Camera Basics

Auto Mode

Other Shooting Modes

P Mode

Playback Mode

Setting Menu

Accessories

Appendix

Index



Shutter Button

To ensure your shots are in focus, always begin by holding the shutter button halfway down, and once the subject is in focus, press the button all the way down to shoot.

In this guide, shutter button operations are described as pressing the button *halfway* or *all the way down*.

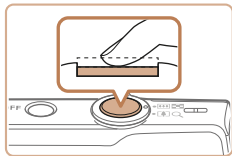

1 Press halfway. (Press lightly to focus.)

- Press the shutter button halfway. The camera beeps twice, and frames are displayed around image areas in focus.

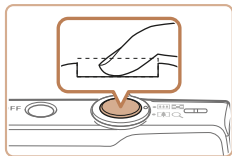

2 Press all the way down. (From the halfway position, press fully to shoot.)

- The camera shoots, as a shutter sound is played.
- Keep the camera still until the shutter sound ends.



- Images may be out of focus if you shoot without initially pressing the shutter button halfway.
- Length of shutter sound playback varies depending on the time required for the shot. It may take longer in some shooting scenes, and images will be blurry if you move the camera (or the subject moves) before the shutter sound ends.

Shooting Display Options

Press the [▼] button to view other information on the screen, or to hide the information. For details on the information displayed, see “On-Screen Information” (📖99).

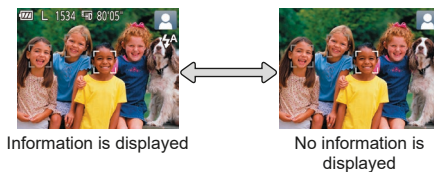

- If the display mode does not change when you press the [▼] button, hold down the [▲] button to disable Easy Auto (📖17).
- Screen brightness is automatically increased by the night view function when you are shooting under low light, making it easier to check how shots are composed. However, on-screen image brightness may not match the brightness of your shots. Note that any on-screen image distortion or jerky subject motion will not affect recorded images.
- For playback display options, see “Switching Display Modes” (📖58).

Before Use

Basic Guide

Advanced Guide

Camera Basics

Auto Mode

Other Shooting Modes

P Mode

Playback Mode

Setting Menu

Accessories

Appendix

Index



Using the FUNC. Menu

Configure commonly used functions through the FUNC. menu as follows. Note that menu items and options vary depending on the shooting mode (📖102 – 103) or playback mode (📖106).



1 Access the FUNC. menu.

- Press the [FUNC.] button.



Menu Items

2 Choose a menu item.

- Press the [▲][▼] buttons to choose a menu item, and then press the [OK] or [▶] button.
- Depending on the menu item, functions can be specified simply by pressing the [OK] or [▶] button, or another screen is displayed for configuring the function.

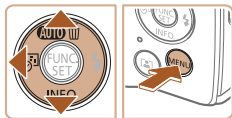

3 Choose an option.

- Press the [▲][▼] buttons to choose an option.
- Items labeled with a [MENU] icon can be configured by pressing the [MENU] button.
- To return to the menu items, press the [◀] button.



4 Confirm your choice and exit.

- Press the [OK] button.
- The screen before you pressed the [OK] button in step 1 is displayed again, showing the option you configured.



- To undo any accidental setting changes, you can restore the camera's default settings (📖76).

Before Use

Basic Guide

Advanced Guide

Camera Basics

Auto Mode

Other Shooting Modes

P Mode

Playback Mode

Setting Menu

Accessories

Appendix

Index



Using the Menu Screen

Configure a variety of camera functions through the menu screen as follows. Menu items are grouped by purpose on tabs, such as shooting [📷], playback [▶], and so on. Note that available menu items vary depending on the selected shooting or playback mode (📖104 – 106).

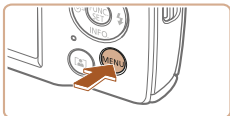

1 Access the menu screen.

- Press the [MENU] button.



2 Choose a tab.

- Move the zoom lever to choose a tab.
- After you have pressed the [▲][▼] buttons to choose a tab initially, you can switch between tabs by pressing the [◀][▶] buttons.

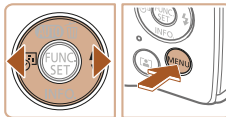
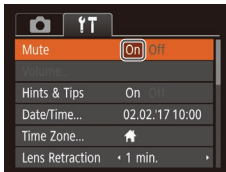
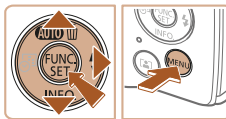
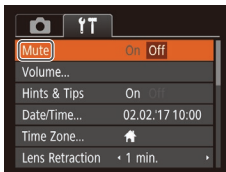
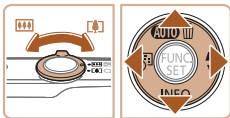

3 Choose a menu item.

- Press the [▲][▼] buttons to choose an item.
- For menu items with options not shown, first press the [⊕] or [⊖] button to switch screens, and then press the [▲][▼] buttons to select the menu item.
- To return to the previous screen, press the [MENU] button.

4 Choose an option.

- Press the [◀][▶] buttons to choose an option.

5 Confirm your choice and exit.

- Press the [MENU] button to return to the screen displayed before you pressed the [MENU] button in step 1.



- To undo any accidental setting changes, you can restore the camera's default settings (📖76).

Before Use

Basic Guide

Advanced Guide

Camera Basics

Auto Mode

Other Shooting Modes

P Mode

Playback Mode

Setting Menu

Accessories

Appendix

Index



Indicator Display

The indicator on the back of the camera (📖4) blinks in green at these times.

- Connected to a computer (📖82)
- Display off (📖21, 71, 72)
- Starting up, recording, or reading
- Communicating with other devices
- Shooting long exposures (📖44)



- When the indicator blinks green, do not turn the camera off, open the memory card/battery cover, or shake or hit the camera, which may corrupt images or damage the camera or memory card.

Before Use

Basic Guide

Advanced Guide

Camera Basics

Auto Mode

Other Shooting Modes

P Mode

Playback Mode

Setting Menu

Accessories

Appendix

Index



Auto Mode

Convenient mode for easy shots with greater control over shooting

Shooting with Camera-Determined

Settings	27
Shooting in Auto Mode.....	27
Disabling Easy Auto.....	28
Scene Icons.....	30
On-Screen Frames.....	30

Common, Convenient Features..... 31

Zooming In Closer on Subjects (Digital Zoom).....	31
Adding a Date Stamp.....	32
Auto Zooming in Response to Subject Movement (Auto Zoom).....	32
Using the Self-Timer.....	33
Deactivating the Flash.....	35
Continuous Shooting.....	35

Image Customization Features..... 36

Changing the Number of Recording Pixels (Image Size).....	36
Changing Movie Image Quality.....	36
Customizing Camera Operation..... 37	
Deactivating the Lamp.....	37
Startup with Easy Auto Disabled.....	37

Before Use

Basic Guide

Advanced Guide

Camera Basics

Auto Mode

Other Shooting
Modes

P Mode

Playback Mode

Setting Menu

Accessories

Appendix

Index



Shooting with Camera-Determined Settings

For fully automatic selection of the optimal settings for specific scenes, simply let the camera determine the subject and shooting conditions. Note that initially, the FUNC./SET button and some others are disabled to prevent mistakes as you learn how to use the camera (Easy Auto).

Still Images

Movies

Shooting in Auto Mode

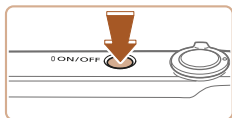

1 Turn the camera on.

- Press the ON/OFF button.
- The startup screen is displayed.



2 Aim the camera at the subject.

- Aim the camera at the subject. The camera will make a slight clicking noise as it determines the scene.
- A scene icon is displayed in the upper right of the screen (see 30).
- Frames displayed around any detected subjects indicate that they are in focus.

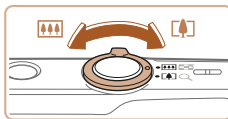

Zoom Bar

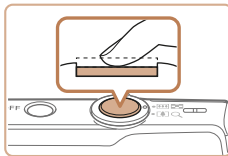

3 Compose the shot.

- To zoom in and enlarge the subject, move the zoom lever toward [] (telephoto), and to zoom away from the subject, move it toward [] (wide angle). (A zoom bar showing the zoom position is displayed.)

4 Shoot.

Shooting Still Images

1 Focus.

- Press the shutter button halfway. The camera beeps twice after focusing, and AF frames are displayed to indicate image areas in focus.
- Several AF frames are displayed when multiple areas are in focus.

Before Use

Basic Guide

Advanced Guide

Camera Basics

Auto Mode

Other Shooting Modes

P Mode

Playback Mode

Setting Menu

Accessories

Appendix

Index



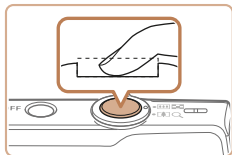

② Shoot.

- Press the shutter button all the way down.
- As the camera shoots, a shutter sound is played, and in low-light conditions, the flash fires automatically.
- Keep the camera still until the shutter sound ends.
- After displaying your shot, the camera will revert to the shooting screen.



Shooting Time



Recording Movies

① Start recording.

- Press the movie button. The camera beeps once as recording begins, and [●Rec] is displayed with the elapsed time.
- Black bars displayed on the top and bottom edges of the screen indicate image areas not recorded.
- Frames displayed around any detected faces indicate that they are in focus.
- Once recording begins, take your finger off the movie button.

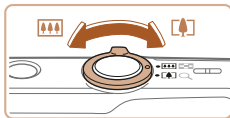

② Resize the subject and recompose the shot as needed.

- To resize the subject, repeat the operations in step 3 (📖27). However, note that the sound of camera operations will be recorded. Note that movies shot at zoom factors shown in blue will look grainy.
- When you recompose shots, the focus, brightness, and colors will be automatically adjusted.

③ Finish recording.

- Press the movie button again to stop recording. The camera beeps twice as recording stops.
- Recording will stop automatically when the memory card becomes full.

Disabling Easy Auto

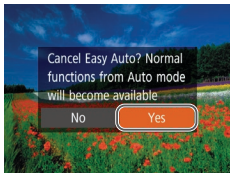

- Press and hold the [▲] button.
- Press the [◀][▶] buttons to choose [Yes], and then press the [OK] button.

Before Use

Basic Guide

Advanced Guide

Camera Basics

Auto Mode

Other Shooting Modes

P Mode

Playback Mode

Setting Menu

Accessories

Appendix

Index



Still Images/Movies

- If the camera makes no operating sounds, it may have been turned on while holding down the [MENU] button. To activate sounds, press the [MENU] button, choose [Mute] on the [Fn] tab, and then press the [Left] [Right] buttons to choose [Off].

Still Images

- A blinking [Shutter] icon warns that images are more likely to be blurred by camera shake. In this case, mount the camera on a tripod or take other measures to keep it still.
- If your shots are dark despite the flash firing, move closer to the subject. For details on the flash range, see “Flash” (108).
- The subject may be too close if the camera only beeps once when you press the shutter button halfway. For details on the range of focus (shooting range), see “Lens” (107).
- To reduce red-eye and to assist in focusing, the lamp may be lit when shooting in low-light conditions.
- A blinking [Flash] icon displayed when you attempt to shoot indicates that shooting is not possible until the flash has finished recharging. Shooting can resume as soon as the flash is ready, so either press the shutter button all the way down and wait, or release it and press it again.
- Although you can shoot again before the shooting screen is displayed, your previous shot may determine the focus, brightness, and colors used.



- You can change how long images are displayed after shots (54).

Movies



- Keep your fingers away from the microphone while recording movies. Blocking the microphone may prevent audio from being recorded or may cause the recording to sound muffled.

- Avoid touching camera controls other than the movie button when recording movies, because sounds made by the camera will be recorded.
- To prevent excessive motion blur when recording movies, mount the camera on a tripod or take other measures to hold it still.



- Audio recording is monaural.

Before Use

Basic Guide

Advanced Guide

Camera Basics

Auto Mode

Other Shooting Modes

P Mode

Playback Mode

Setting Menu

Accessories

Appendix

Index



Scene Icons

In **[AUTO]** mode, shooting scenes determined by the camera are indicated by the icon displayed, and corresponding settings are automatically selected for optimal focusing, subject brightness, and color.

Subject Background	People			Other Subjects			Icon Background Color
	In Motion*1	Shadows on Face*1		In Motion*1	At Close Range		
Bright							Gray
Backlit			—				
With Blue Sky							Light Blue
Backlit			—				
Sunsets	—				—		Orange
Spotlights							Dark Blue
Dark							
Tripod Used		—			—		

*1 Not displayed for movies.

*2 Displayed in dark scenes when the camera is held still, as when mounted on a tripod.



- Try shooting in **[P]** mode (📖45) if the scene icon does not match actual shooting conditions, or if it is not possible to shoot with your expected effect, color, or brightness.

On-Screen Frames

A variety of frames are displayed once the camera detects subjects you are aiming the camera at.

- A white frame is displayed around the subject (or person's face) determined by the camera to be the main subject, and gray frames are displayed around other detected faces. Frames follow moving subjects within a certain range to keep them in focus. However, if the camera detects subject movement, only the white frame will remain on the screen.
- When you are pressing the shutter button halfway and the camera detects subject movement, a blue frame is displayed, and the focus and image brightness are constantly adjusted (Servo AF).



- Try shooting in **[P]** mode (📖45) if no frames are displayed, if frames are not displayed around desired subjects, or if frames are displayed on the background or similar areas.



Common, Convenient Features

Still Images

Movies

Zooming In Closer on Subjects (Digital Zoom)

When distant subjects are too far away to enlarge using the optical zoom, use digital zoom for up to about 32x enlargement.

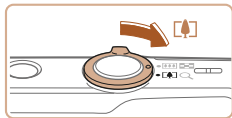

1 Move the zoom lever toward [ZOOM IN].

- Hold the lever until zooming stops.
- Zooming stops at the largest zoom factor before the image becomes noticeably grainy, which is then indicated on the screen.

2 Move the zoom lever toward [ZOOM IN] again.

- The camera zooms in even closer on the subject.

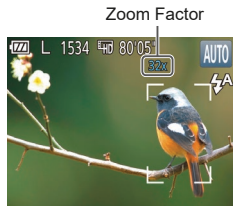

- Moving the zoom lever will display the zoom bar (which indicates the zoom position). The zoom bar is color-coded to indicate the zoom range.
 - White range: optical zoom range where the image will not appear grainy.
 - Yellow range: digital zoom range where the image is not noticeably grainy (ZoomPlus).
 - Blue range: digital zoom range where the image will appear grainy. Because the blue range will not be available at some recording pixel settings (36), the maximum zoom factor can be achieved by following step 1.
- Zoomed images may look grainy under some recording pixel settings (36) and zoom factors. In this case, the zoom factor is shown in blue.

Before Use

Basic Guide

Advanced Guide

Camera Basics

Auto Mode

Other Shooting Modes

P Mode

Playback Mode

Setting Menu

Accessories

Appendix

Index



Adding a Date Stamp

The camera can add the shooting date to images, in the lower-right corner. However, note that date stamps cannot be edited or removed, so confirm beforehand that the date and time are correct (📖13).



1 Configure the setting.

- Press the [◀] button to choose the desired option.
- Once the setting is complete, [📅] or [🕒] is displayed.



2 Shoot.

- As you take shots, the camera adds the shooting date or time to the lower-right corner of images.
- To restore the original setting, choose [🔍] in step 1.



- Date stamps cannot be edited or removed.



- Shots taken without adding a date stamp can be printed with one as follows. However, adding a date stamp this way to images that already have one may cause it to be printed twice.
 - Print using printer functions (📖85)
 - Use camera DPOF print settings (📖88) to print
 - Use the software downloaded from the Canon website (📖81) to print

Auto Zooming in Response to Subject Movement (Auto Zoom)

The camera automatically zooms in and out to keep a detected face (📖27) at a constant size. If the person moves closer, the camera automatically zooms out, and vice versa.

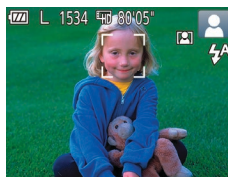
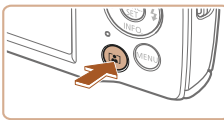

1 Enter Auto Zoom mode.

- Press the [FACE] button.
- [FACE] is displayed.
- A white frame is displayed around the detected face, and the camera zooms in and out to keep the subject on the screen.
- When multiple faces are detected, a white frame is displayed around the main subject's face and up to two gray frames around other faces, as the camera zooms to keep these subjects on the screen.



2 Shoot.

- Auto zooming continues even after you shoot, and the frames are still displayed.
- To cancel auto zooming, press the [] button again. [] is displayed.



- Faces may not be detected at some zoom factors, or if the subject's head is tilted or facing the camera indirectly.
- Auto zooming is deactivated in the following situations.
 - When you change the shooting mode
 - When you press the [MENU] button, movie button, or [] button
 - When you press the [] button



- When a detected subject moves toward the edge of the screen, the camera zooms out to keep the subject on the screen.
- The zoom factor cannot be changed after you press the shutter button all the way down in self-timer mode (33).
- The camera prioritizes zooming to keep subjects on the screen. For this reason, it may not be possible to maintain a constant face display size, depending on subject movement and shooting conditions.
- When no face is detected, the camera zooms to a certain level and stops zooming until a face is detected.

Still Images

Movies

Using the Self-Timer

With the self-timer, you can include yourself in group photos or other timed shots. The camera will shoot about 10 seconds after you press the shutter button.



1 Configure the setting.

- Press the [] button, choose [] in the menu, and then choose [] (23).
- Once the setting is complete, [] is displayed.

2 Shoot.

- For Still Images: Press the shutter button halfway to focus on the subject, and then press it all the way down.
- For Movies: Press the movie button.

Before Use

Basic Guide

Advanced Guide

Camera Basics

Auto Mode

Other Shooting Modes

P Mode

Playback Mode

Setting Menu

Accessories

Appendix

Index



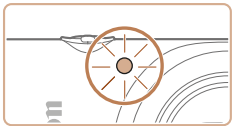

- Once you start the self-timer, the lamp will blink and the camera will play a self-timer sound.
- Two seconds before the shot, the blinking and sound will speed up. (The lamp will remain lit in case the flash fires.)
- To cancel shooting after you have triggered the self-timer, press the [MENU] button.
- To restore the original setting, choose [OFF] in step 1.

Still Images

Movies

Using the Self-Timer to Avoid Camera Shake

This option delays shutter release until about two seconds after you have pressed the shutter button. If the camera is unsteady while you are pressing the shutter button, it will not affect your shot.



- Follow step 1 in “Using the Self-Timer” (33) and choose [ON].
- Once the setting is complete, [ON] is displayed.
- Follow step 2 in “Using the Self-Timer” (33) to shoot.

Customizing the Self-Timer

You can specify the delay (0 – 30 seconds) and number of shots (1 – 10).

Still Images

Movies

1 Choose [ON].

- Following step 1 in “Using the Self-Timer” (33), choose [ON] and press the [MENU] button.

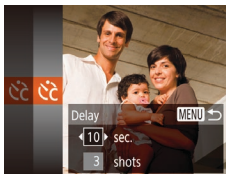

2 Configure the setting.

- Press the [▲][▼] buttons to choose [Delay] or [Shots].
- Press the [◀][▶] buttons to choose a value, and then press the [OK] button.
- Once the setting is complete, [ON] is displayed.
- Follow step 2 in “Using the Self-Timer” (33) to shoot.



- For movies shot using the self-timer, [Delay] represents the delay before recording begins, but the [Shots] setting has no effect.



- When you specify multiple shots, image brightness and white balance are determined by the first shot. More time is required between shots when the flash fires or when you have specified to take many shots. Shooting will stop automatically when the memory card becomes full.
- When a delay longer than two seconds is specified, two seconds before the shot, the lamp blinking and self-timer sound will speed up. (The lamp will remain lit in case the flash fires.)

Before Use

Basic Guide

Advanced Guide

Camera Basics

Auto Mode

Other Shooting Modes

P Mode

Playback Mode

Setting Menu

Accessories

Appendix

Index



Deactivating the Flash

Prepare the camera for shooting without the flash as follows.

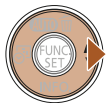

- Press the [▶] button several times until [⚡] is displayed.
- The flash will no longer be activated.
- To activate the flash, press the [▶] button again. ([⚡]) is displayed.) The flash will automatically fire in low-light conditions.



- If a blinking [⚡] icon is displayed when you press the shutter button halfway in camera-shake inducing, low-light conditions, mount the camera on a tripod or take other measures to keep it still.

Continuous Shooting

Hold the shutter button all the way down to shoot continuously.
For details on the continuous shooting speed, see “Shooting” (108).



1 Configure the setting.

- Press the [MENU] button, choose [] in the menu, and then choose [] (23).
- Once the setting is complete, [] is displayed.

2 Shoot.

- Hold the shutter button all the way down to shoot continuously.



- Cannot be used with the self-timer (33).
- Shooting may stop momentarily or continuous shooting may slow down depending on shooting conditions, camera settings, and the zoom position.
- As more shots are taken, shooting may slow down.
- Shooting may slow down if the flash fires.



Image Customization Features

Still Images

Changing the Number of Recording Pixels (Image Size)

Choose the image's number of recording pixels from 5 levels, as follows. For guidelines on how many shots at each recording pixel setting can fit on a memory card, see "Recording" (108).



- Press the **[FUNC.]** button, choose **[L]** in the menu, and choose the desired option (23).
- The option you configured is now displayed.
- To restore the original setting, repeat this process but choose **[L]**.

Guidelines for Choosing Recording Pixel Setting Based on Paper Size

A2 (16.5 x 23.4 in.)	L
A3 – A5 (11.7 x 16.5 – 5.8 x 8.3 in.)	M1
5 x 7 in. Postcard 3.5 x 5 in.	M2

- **[S]**: For e-mailing images.
- **[M]**: For images displayed on widescreen HDTVs or similar display devices, on a 16:9 screen.

Changing Movie Image Quality

Movies

Two image quality settings are available. For guidelines on the total recording time for movies at each level of image quality that will fit on a memory card, see "Recording" (108).



- Press the **[FUNC.]** button, choose **[HD]** in the menu, and choose the desired option (23).
- The option you configured is now displayed.
- To restore the original setting, repeat this process but choose **[HD]**.

Image Quality	Number of Recording Pixels	Frame Rate	Details
[HD]	1280 x 720	25 fps	For shooting in HD.
[VGA]	640 x 480	30 fps	For shooting in standard definition.



- In **[HD]** mode, black bars displayed on the top and bottom edges of the screen indicate image areas not recorded.

Before Use

Basic Guide

Advanced Guide

Camera Basics

Auto Mode

Other Shooting Modes

P Mode

Playback Mode

Setting Menu

Accessories

Appendix

Index



Customizing Camera Operation

Customize shooting functions on the [CAMERA] tab of the menu screen as follows.

For instructions on menu functions, see “Using the Menu Screen” (p.24).

Deactivating the Lamp

You can deactivate the lamp that normally lights up to help you focus in low-light conditions when you press the shutter button halfway, or that lights up to reduce red-eye when you shoot in low-light conditions with the flash.

Still Images

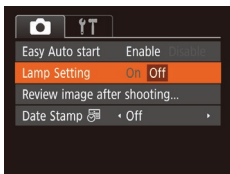

- Press the [MENU] button, choose [Lamp Setting] on the [CAMERA] tab, and then choose [Off] (p.24).
- To restore the original setting, repeat this process but choose [On].

Startup with Easy Auto Disabled

Easy Auto activation at startup can be disabled.

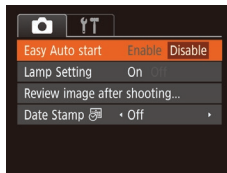

- Press the [MENU] button, choose [Easy Auto start] on the [CAMERA] tab, and then choose [Disable] (p.24).
- To restore the original setting, repeat this process but choose [Enable].

Before Use

Basic Guide

Advanced Guide

Camera Basics

Auto Mode

Other Shooting Modes

P Mode

Playback Mode

Setting Menu

Accessories

Appendix

Index



Other Shooting Modes

Shoot more effectively in various scenes, and take shots enhanced with unique image effects or captured using special functions

Specific Scenes	39	Applying Special Effects	40	Special Modes for Other Purposes	43
Shooting with Reduced Motion Blur (Digital IS)	40	Shooting with a Fish-Eye Lens Effect (Fish-Eye Effect)	41	Auto Shooting after Detecting New Person (Face Self-Timer)	43
		Shots Resembling Miniature Models (Miniature Effect).....	41	Shooting Long Exposures (Long Shutter).....	44
		Shooting with a Toy Camera Effect (Toy Camera Effect)	42		
		Shooting in Monochrome	43		

Before Use

Basic Guide

Advanced Guide

Camera Basics

Auto Mode

Other Shooting
Modes

P Mode

Playback Mode

Setting Menu

Accessories

Appendix

Index



Specific Scenes

Choose a mode matching the shooting scene, and the camera will automatically configure the settings for optimal shots.



1 Choose a shooting mode.

- Press the [▲] button several times until [P] is displayed.
- Press the [⊕] button, choose [P] in the menu, and choose the desired option (📖23).

2 Shoot.



Still Images

Movies

👤 Shooting Portraits (Portrait)

- Take shots of people with a softening effect.



Still Images

🌙 Shooting under Low Light (Low Light)

- Shoot with minimal camera and subject shake even in low-light conditions.



Still Images

Movies

🎆 Shooting Fireworks (Fireworks)

- Vivid shots of fireworks.



- In [📷] mode, mount the camera on a tripod or take other measures to keep it still and prevent camera shake.



- If the shooting mode does not change when you press the [▲] button, hold down the [▲] button to disable Easy Auto (📖28).
- [📷] mode recording pixel setting is [M] (2560 x 1920) and cannot be changed.
- In [📷] mode, although no frames are displayed when you press the shutter button halfway, optimal focus is still determined.

Before Use

Basic Guide

Advanced Guide

Camera Basics

Auto Mode

Other Shooting Modes

P Mode

Playback Mode

Setting Menu

Accessories

Appendix



Index





Shooting with Reduced Motion Blur (Digital IS)

Shoot with minimal camera and subject shake. In scenes where the flash is not fired, consecutive shots are combined to reduce camera shake and noise.

1 Enter mode.

- Follow step 1 in “Specific Scenes” ( 39) and choose .

2 Shoot.

- Press the shutter button halfway.  is displayed on the left side of the screen in scenes where the flash is not fired.
- When  is displayed, press the shutter button all the way down. Images will be shot continuously, and then be combined.
- When the icon is not displayed, press the shutter button all the way down to shoot a single image.

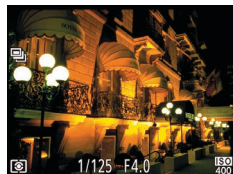

- Because the camera will shoot continuously when  is displayed, hold it steady while shooting.
- In some scenes, images may not look as expected.



- When using a tripod, shoot in [AUTO] mode ( 27).
-  mode recording pixel setting is [M] (2560 x 1920) and cannot be changed.

Applying Special Effects

Add a variety of effects to images when shooting.

1 Choose a shooting mode.

- Follow step 1 in “Specific Scenes” ( 39) to choose a shooting mode.

2 Shoot.



Still Images

Movies

Shooting in Vivid Colors (Super Vivid)

- Shots in rich, vivid colors.





Still Images

Movies

Posterized Shots (Poster Effect)

- Shots that resemble an old poster or illustration.



- In  and  modes, try taking some test shots first, to make sure you obtain the desired results.

Before Use

Basic Guide

Advanced Guide

Camera Basics

Auto Mode

Other Shooting Modes

P Mode

Playback Mode

Setting Menu

Accessories

Appendix

Index



Shooting with a Fish-Eye Lens Effect (Fish-Eye Effect)

Shoot with the distorting effect of a fish-eye lens.

1 Choose [📷].

- Follow step 1 in “Specific Scenes” (📖39) and choose [📷].

2 Choose an effect level.

- Press the [▼] button, press the [◀][▶] buttons to choose an effect level, and then press the [📷] button.
- A preview is shown of how your shot will look with the effect applied.

3 Shoot.

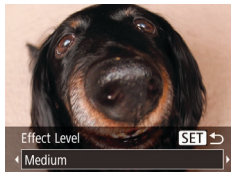

- Try taking some test shots first, to make sure you obtain the desired results.

Shots Resembling Miniature Models (Miniature Effect)

Creates the effect of a miniature model, by blurring image areas above and below your selected area.

You can also make movies that look like scenes in miniature models by choosing the playback speed before the movie is recorded. People and objects in the scene will move quickly during playback. Note that sound is not recorded.

1 Choose [📷].

- Follow step 1 in “Specific Scenes” (📖39) and choose [📷].
- A white frame is displayed, indicating the image area that will not be blurred.

2 Choose the area to keep in focus.

- Press the [▼] button.
- Move the zoom lever to resize the frame, and press the [▲][▼] buttons to move it.



3 For movies, choose the movie playback speed.

- Press the [MENU] button, and then press the [◀][▶] buttons to choose the speed.

4 Return to the shooting screen and shoot.

- Press the [MENU] button to return to the shooting screen, and then shoot.



Playback Speed and Estimated Playback Time (for One-Minute Clips)

Speed	Playback Time
5x	Approx. 12 sec.
10x	Approx. 6 sec.
20x	Approx. 3 sec.



- The zoom is not available when shooting movies. Be sure to set the zoom before shooting.
- Try taking some test shots first, to make sure you obtain the desired results.



- To switch the orientation of the frame to vertical, press the [◀][▶] buttons in step 2. To return the frame to horizontal orientation, press the [▲][▼] buttons.
- To move the frame when it is in horizontal orientation, press the [▲][▼] buttons, and to move the frame when it is in vertical orientation, press the [◀][▶] buttons.
- Holding the camera vertically will change the orientation of the frame.
- Movie image quality is [E][V][GA] when a still image recording pixel setting of [L] is selected and [E][HD] when a still image recording pixel setting of [W] is selected ([36]). These quality settings cannot be changed.

Shooting with a Toy Camera Effect (Toy Camera Effect)

This effect makes images resemble shots from a toy camera by vignetting (darker, blurred image corners) and changing the overall color.



1 Choose [📷].

- Follow step 1 in “Specific Scenes” ([39]) and choose [📷].

2 Choose a color tone.

- Press the [▼] button, press the [◀][▶] buttons to choose a color tone, and then press the [📷] button.
- A preview is shown of how your shot will look with the effect applied.

3 Shoot.

Standard	Shots resemble toy camera images.
Warm	Images have a warmer tone than with [Standard].
Cool	Images have a cooler tone than with [Standard].



- Try taking some test shots first, to make sure you obtain the desired results.



Shooting in Monochrome

Shoot images in black and white, sepia, or blue and white.

1 Choose [📷].

- Follow step 1 in “Specific Scenes” (📖39) and choose [📷].

2 Choose a color tone.

- Press the [▼] button, press the [◀][▶] buttons to choose a color tone, and then press the [📷] button.
- A preview is shown of how your shot will look with the effect applied.

3 Shoot.



B/W	Black and white shots.
Sepia	Sepia tone shots.
Blue	Blue and white shots.

Special Modes for Other Purposes

Auto Shooting after Detecting New Person (Face Self-Timer)

The camera will shoot about two seconds after detecting that the face of another person (such as the photographer) has entered the shooting area (📖50). This is useful when including yourself in group photos or similar shots.

1 Choose [📷].

- Follow step 1 in “Specific Scenes” (📖39) and choose [📷].

2 Compose the shot and press the shutter button halfway.

- Make sure a green frame is displayed around the face you focus on and white frames around other faces.

3 Press the shutter button all the way down.

- The camera now enters shooting standby mode, and [Look straight at camera to start count down] is displayed.
- The lamp blinks and the self-timer sound is played.





4 Join the subjects in the shooting area and look at the camera.

- After the camera detects a new face, the lamp blinking and self-timer sound will speed up. (When the flash fires, the lamp will remain lit.) About two seconds later, the camera will shoot.
- To cancel shooting after you have triggered the self-timer, press the **[MENU]** button.



- Even if your face is not detected after you join the others in the shooting area, the camera will shoot about 15 seconds later.
- To change the number of shots, press the **[▼]** button, press the **[◀]** **[▶]** buttons to choose the number of shots, and then press the **[OK]** button.

Shooting Long Exposures (Long Shutter)

Specify a shutter speed of 1 – 15 seconds to shoot long exposures. In this case, mount the camera on a tripod or take other measures to prevent camera shake.

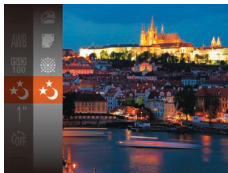

1 Choose [***]**.

- Follow step 1 in “Specific Scenes” (**39**) and choose [***]**.

2 Choose the shutter speed.

- Press the **[OK]** button, choose [**1"**] in the menu, and choose the desired shutter speed (**23**).

3 Check the exposure.

- Press the shutter button halfway to view the exposure for your selected shutter speed.

4 Shoot.



- On-screen image brightness in step 3, when you pressed the shutter button halfway, may not match the brightness of your shots.
- With shutter speeds of 1.3 seconds or slower, there will be a delay before you can shoot again, as the camera processes images to reduce noise.



- If the flash fires, your shot may be overexposed. In this case, set the flash to **[OFF]** and shoot again (**53**).



P Mode

More discerning shots, in your preferred shooting style

- Instructions in this chapter apply to the camera when set to [P] mode.
- [P]: Program AE; AE: Auto Exposure
- Before using a function introduced in this chapter in modes other than [P], make sure the function is available in that mode (📖101 – 105).

Shooting in Program AE ([P] Mode)	46	Adjusting White Balance	48	Flash	53
Image Brightness (Exposure)	46	Shooting Range and Focusing	49	Changing the Flash Mode	53
Adjusting Image Brightness (Exposure Compensation)	46	Shooting Close-Ups (Macro)	49	Other Settings	54
Changing the Metering Method	47	Shooting Distant Subjects (Infinity)	50	Displaying Grid Lines	54
Changing the ISO Speed	47	Changing the AF Frame Mode	50	Deactivating the Digital Zoom	54
Correcting Image Brightness (i-Contrast)	48	Changing the Focus Setting	52	Changing the Image Display Style after Shots	54

Before Use

Basic Guide

Advanced Guide

Camera Basics

Auto Mode

Other Shooting
Modes

P Mode

Playback Mode

Setting Menu

Accessories

Appendix

Index



Shooting in Program AE ([P] Mode)

You can customize many function settings to suit your preferred shooting style.



1 Enter [P] mode.

- Follow step 1 in “Specific Scenes” (📖39) and choose [P].

2 Customize the settings as desired (📖46 – 55), and then shoot.



- If the optimum exposure cannot be obtained when you press the shutter button halfway, the shutter speed and aperture value are displayed in orange. In this case, try adjusting the ISO speed (📖47) or activating the flash (if subjects are dark, 📖53), which may enable optimum exposure.
- Movies can be recorded in [P] mode as well, by pressing the movie button. However, some FUNC. (📖23) and MENU (📖24) settings may be automatically adjusted for movie recording.
- For details on the shooting range in [P] mode, see “Lens” (📖107).

Image Brightness (Exposure)

Adjusting Image Brightness (Exposure Compensation)

The standard exposure set by the camera can be adjusted in 1/3-stop increments, in a range of -2 to +2.



- Press the [Fn] button and choose [±0] in the menu. As you watch the screen, press the [▲][▼] buttons to adjust brightness (📖23).
- When shooting movies, shoot with the exposure compensation bar displayed.
- When shooting still images, press the [Fn] button to display the set exposure compensation amount, and then shoot.



- You can also shoot still images with exposure compensation bar displayed.
- While recording a movie, [AEL] is displayed, and the exposure is locked.



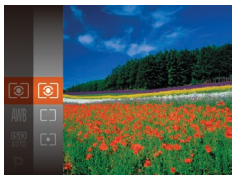

Changing the Metering Method

Adjust the metering method (how brightness is measured) to suit shooting conditions as follows.



- Press the $\left[\text{METER} \right]$ button, choose $\left[\text{METER} \right]$ in the menu, and choose the desired option (📖23).
- The option you configured is now displayed.

 Evaluative	For typical shooting conditions, including backlit shots. Automatically adjusts exposure to match the shooting conditions.
 Center Weighted Avg.	Determines the average brightness of light across the entire image area, calculated by treating brightness in the central area as more important.
 Spot	Metering restricted to within the $\left[\text{AE} \right]$ (Spot AE Point frame), displayed in the center of the screen.

Changing the ISO Speed

Set the ISO speed to [AUTO] for automatic adjustment to suit the shooting mode and conditions. Otherwise, set a higher ISO speed for higher sensitivity, or a lower value for lower sensitivity.

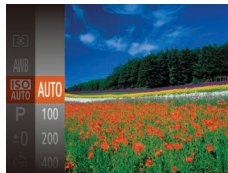

- Press the $\left[\text{ISO} \right]$ button, choose $\left[\text{ISO} \right]$ in the menu, and choose the desired option (📖23).
- The option you configured is now displayed.



- To view the automatically determined ISO speed when you have set the ISO speed to [AUTO], press the shutter button halfway.
- Although choosing a lower ISO speed may reduce image graininess, there may be a greater risk of subject and camera shake in some shooting conditions.
- Choosing a higher ISO speed will increase shutter speed, which may reduce subject and camera shake and increase the flash range. However, shots may look grainy.



Correcting Image Brightness (i-Contrast)

Before shooting, excessively bright or dark image areas (such as faces or backgrounds) can be detected and automatically adjusted to the optimal brightness. Insufficient overall image contrast can also be automatically corrected before shooting to make subjects stand out better.

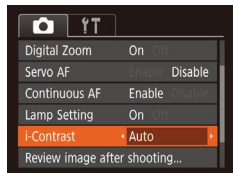

- Press the [MENU] button, choose [i-Contrast] on the [CAMERA] tab, and then choose [Auto] (📖24).
- Once the setting is complete, [C] is displayed.



- Under some shooting conditions, correction may be inaccurate or may cause images to appear grainy.



- You can also correct existing images (📖67).

Adjusting White Balance

By adjusting white balance (WB), you can make image colors look more natural for the scene you are shooting.

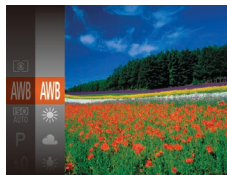

- Press the [WB] button, choose [AWB] in the menu, and choose the desired option (📖23).
- The option you configured is now displayed.

AWB	Auto	Automatically sets the optimal white balance for the shooting conditions.
	Day Light	For shooting outdoors in fair weather.
	Cloudy	For shooting in cloudy conditions, in the shade, or at twilight.
	Tungsten	For shooting under ordinary incandescent (tungsten) lighting and similarly colored fluorescent lighting.
	Fluorescent	For shooting under warm-white (or similarly colored) or cool-white fluorescent lighting.
	Fluorescent H	For shooting under daylight fluorescent and similarly colored fluorescent lighting.
	Custom	For manually setting a custom white balance (📖49).



Custom White Balance

For image colors that look natural under the light in your shot, adjust white balance to suit the light source where you are shooting. Set the white balance under the same light source that will illuminate your shot.

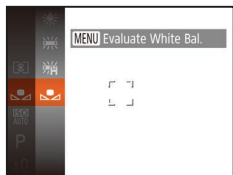

- Follow the steps in “Adjusting White Balance” (📖48) to choose [📷].
- Aim the camera at a plain white subject, so that the entire screen is white. Press the [MENU] button.
- The tint of the screen changes once the white balance data has been recorded.



- Colors may look unnatural if you change camera settings after recording white balance data.

Shooting Range and Focusing

Shooting Close-Ups (Macro)

To restrict the focus to subjects at close range, set the camera to [🌻]. For details on the range of focus, see “Lens” (📖107).

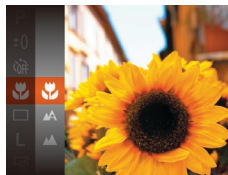

- Press the [📷] button, choose [🌻] in the menu, and then choose [🌻] (📖23).
- Once the setting is complete, [🌻] is displayed.



- If the flash fires, vignetting may occur.
- In the yellow bar display area below the zoom bar, [🌻] will turn gray and the camera will not focus.



- To prevent camera shake, try mounting the camera on a tripod and shooting with the camera set to [🌻] (📖34).



Shooting Distant Subjects (Infinity)

To restrict the focus to distant subjects, set the camera to [∞]. For details on the range of focus, see "Lens" (📖107).



- Press the [∞] button, choose [∞] in the menu, and then choose [∞] (📖23).
- Once the setting is complete, [∞] is displayed.

Changing the AF Frame Mode

Change the AF (auto focus) frame mode to suit the shooting conditions as follows.



- Press the [MENU] button, choose [AF Frame] on the [📷] tab, and then choose the desired option (📖24).

Face AiAF

- Detects people's faces, and then sets the focus, exposure (evaluative metering only), and white balance ([AWB] only).
 - After you aim the camera at the subject, a white frame is displayed around the person's face determined by the camera to be the main subject, and up to two gray frames are displayed around other detected faces.
 - When the camera detects movement, frames will follow moving subjects, within a certain range.
 - After you press the shutter button halfway, up to nine green frames are displayed around faces in focus.
- ⚠️
- If faces are not detected, or when only gray frames are displayed (without a white frame), up to nine green frames are displayed in the areas in focus when you press the shutter button halfway.
 - If faces are not detected when Servo AF (📖51) is set to [Enable], the AF frame is displayed in the center of the screen when you press the shutter button halfway.
 - Examples of faces that cannot be detected:
 - Subjects that are distant or extremely close
 - Subjects that are dark or light
 - Faces in profile, at an angle, or partly hidden
 - The camera may misinterpret non-human subjects as faces.
 - No AF frames are displayed if the camera cannot focus when you press the shutter button halfway.



Choosing Subjects to Focus On (Tracking AF)

Shoot after choosing a subject to focus on as follows.

1 Choose [Tracking AF].

- Follow the steps in “Changing the AF Frame Mode” (📖50) to choose [Tracking AF].
- [☐] is displayed in the center of the screen.

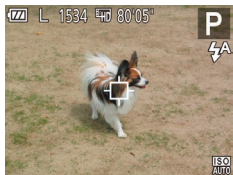

2 Choose a subject to focus on.

- Aim the camera so that [☐] is on the desired subject.
- Press the shutter button halfway. [☐] changes to a blue [■], which follows the subject as the camera continues to adjust the focus and exposure (Servo AF) (📖51).

3 Shoot.

- Press the shutter button all the way down to shoot.

- ⚠ [Servo AF] (📖51) is set to [Enable] and cannot be changed.
- Tracking may not be possible when subjects are too small or move too rapidly, or when subject color or brightness matches that of the background too closely.
- 🌸 and 🏔 are not available.

Center

One AF frame is displayed in the center. Effective for reliable focusing.

- ⚠ A yellow AF frame is displayed with [⦿] if the camera cannot focus when you press the shutter button halfway.

- ✎ To compose shots so that subjects are positioned at the edge or in a corner, first aim the camera to capture the subject in an AF frame, and then hold the shutter button halfway down. As you continue to hold the shutter button halfway, recompose the shot as desired, and then press the shutter button all the way down (Focus Lock).

Still Images

Shooting with Servo AF

This mode helps avoid missing shots of subjects in motion, because the camera continues to focus on the subject and adjust the exposure as long as you press the shutter button halfway.

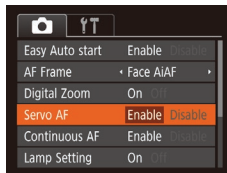

1 Configure the setting.

- Press the [MENU] button, choose [Servo AF] on the [📷] tab, and then choose [Enable] (📖24).

2 Focus.

- The focus and exposure are maintained where the blue AF frame is displayed while you are pressing the shutter button halfway.





- Focusing may not be possible in some shooting conditions.
- In low-light conditions, Servo AF may not be activated (AF frames may not turn blue) when you press the shutter button halfway. In this case, the focus and exposure are set according to the specified AF frame mode.
- If optimum exposure cannot be obtained, the shutter speed and aperture value are displayed in orange. Release the shutter button, and then press it halfway again.
- Not available when using the self-timer (📖33).

Changing the Focus Setting

You can change default camera operation of constantly focusing on subjects it is aimed at, even when the shutter button is not pressed. Instead, you can limit camera focusing to the moment you press the shutter button halfway.

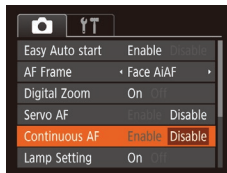

- Press the [MENU] button, choose [Continuous AF] on the [📷] tab, and then choose [Disable] (📖24).

Enable	Helps avoid missing sudden photo opportunities, because the camera constantly focuses on subjects until you press the shutter button halfway.
Disable	Conserves battery power, because the camera does not focus constantly.

Before Use

Basic Guide

Advanced Guide

Camera Basics

Auto Mode

Other Shooting Modes

P Mode

Playback Mode

Setting Menu

Accessories

Appendix

Index



Flash

Still Images

Changing the Flash Mode

You can change the flash mode to match the shooting scene. For details on the flash range, see “Flash” (108).



- Press the [▶] button, press the [◀][▶] buttons to choose a flash mode, and then press the [OK] button.
- The option you configured is now displayed.

[A] Auto

Fires automatically in low-light conditions.

[] On

Fires for each shot.

[] Slow Synchro

Fires to illuminate the main subject (such as people) while shooting at a slower shutter speed to illuminate backgrounds out of flash range.

- ! In [] mode, mount the camera on a tripod or take other measures to keep it still and prevent camera shake.
- ! In [] mode, even after the flash fires, ensure that the main subject does not move until the shutter sound is finished playing.

[] Off

For shooting without the flash.

- ! If a blinking [] icon is displayed when you press the shutter button halfway in camera-shake inducing, low-light conditions, mount the camera on a tripod or take other measures to keep it still.

Before Use

Basic Guide

Advanced Guide

Camera Basics

Auto Mode

Other Shooting Modes

P Mode

Playback Mode

Setting Menu

Accessories

Appendix

Index



Other Settings

Still Images

Movies

Displaying Grid Lines

Grid lines can be displayed on the screen for vertical and horizontal reference while shooting.

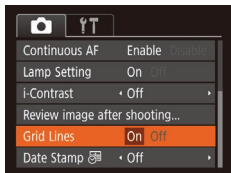

- Press the [MENU] button, choose [Grid Lines] on the [CAMERA] tab, and then choose [On] (📖24).
- Once the setting is complete, grid lines are displayed on the screen.



- Grid lines are not recorded in your shots.

Still Images

Movies

Deactivating the Digital Zoom

If you prefer not to use the digital zoom (📖31), you can deactivate it as follows.

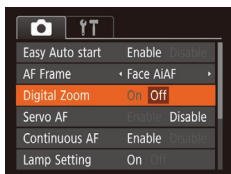

- Press the [MENU] button, choose [Digital Zoom] on the [CAMERA] tab, and then choose [Off] (📖24).

Still Images

Changing the Image Display Style after Shots

You can change how long images are displayed and what information is displayed immediately after shooting.

Changing the Image Display Period after Shots

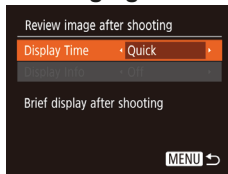

1 Access the [Review image after shooting] screen.

- Press the [MENU] button, choose [Review image after shooting] on the [CAMERA] tab, and then press the [OK] button (📖24).

2 Configure the setting.

- Choose [Display Time], and then choose the desired option (📖24).

Quick	Displays images only until you can shoot again.
2 sec., 4 sec., 8 sec.	Displays images for the specified time. Even while the shot is displayed, you can take another shot by pressing the shutter button halfway again.
Hold	Displays images until you press the shutter button halfway.
Off	No image display after shots.

Before Use

Basic Guide

Advanced Guide

Camera Basics

Auto Mode

Other Shooting Modes

P Mode

Playback Mode

Setting Menu

Accessories

Appendix

Index



Changing the Screen Displayed after Shots

Change the way images are displayed after shots as follows.

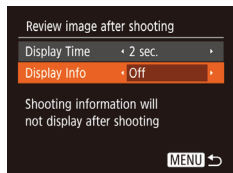

1 Set [Display Time] to [2 sec.], [4 sec.], [8 sec.], or [Hold] (📖54).

2 Configure the setting.

- Choose [Display Info], and then choose the desired option (📖24).

Off	Displays only the image.
Detailed	Displays shooting details (📖100).



- When [Display Time] (📖54) is set to [Off] or [Quick], [Display Info] is set to [Off] and cannot be changed.
- By pressing the [▼] button while an image is displayed after shooting, you can switch the display information. Note that the settings of [Display Info] are not changed. You can also erase images by pressing the [🗑️] button, or protect images (📖61) by pressing the [🔒] button.



Playback Mode

Have fun reviewing your shots, and browse or edit them in many ways

- To prepare the camera for these operations, press the  button to enter Playback mode.



- It may not be possible to play back or edit images that were renamed or already edited on a computer, or images from other cameras.

Viewing	57	Protecting Images	61	Editing Still Images	67
Switching Display Modes	58	Using the Menu	62	Resizing Images.....	67
Browsing and Filtering Images	58	Choosing Images Individually	62	Correcting Image Brightness (i-Contrast).....	67
Navigating through Images in an Index.....	58	Selecting a Range.....	62	Correcting Red-Eye.....	68
Finding Images Matching Specified Conditions	59	Protecting All Images at Once.....	63		
Image Viewing Options	60	Erasing Images	64		
Magnifying Images	60	Erasing Multiple Images at Once	64		
Viewing Slideshows	60	Rotating Images	66		
		Using the Menu	66		
		Deactivating Auto Rotation.....	66		

Before Use

Basic Guide

Advanced Guide

Camera Basics

Auto Mode

Other Shooting Modes

P Mode

Playback Mode

Setting Menu

Accessories

Appendix

Index



Viewing

After shooting images or movies, you can view them on the screen as follows.



1 Enter Playback mode.

- Press the [▶] button.
- Your last shot is displayed.



2 Choose images.

- To view the previous image, press the [◀] button. To view the next image, press the [▶] button.
- Press and hold the [◀][▶] buttons to browse through images quickly.



- Movies are identified by a [SET ▶] icon. To play movies, go to step 3.



Volume Indicator

3 Play movies.

- To start playback, press the [▶] button, press the [▲][▼] buttons to choose [▶], and then press the [⊞] button again.

4 Adjust the volume.

- Press the [▲][▼] buttons to adjust the volume.
- To adjust the volume when the volume indicator is no longer displayed, press the [▲][▼] buttons.

5 Pause playback.

- To pause or resume playback, press the [⊞] button.
- After the movie is finished, [SET ▶] is displayed.



- To switch to Shooting mode from Playback mode, press the shutter button halfway.
- To have the most recent shot displayed when you enter Playback mode, choose MENU (24) > [▶] tab > [Resume] > [Last shot].
- To change the transition shown between images, access MENU (24) and choose your desired effect on the [▶] tab > [Transition].



Switching Display Modes

Press the [▼] button to view other information on the screen, or to hide the information. For details on the information displayed, see “Playback (Detailed Information Display)” (100).



Overexposure Warning (for Image Highlights)

Washed-out highlights in the image flash on the screen in detailed information display (58).

Histogram

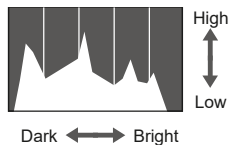

- The graph in detailed information display (58) is a histogram showing the distribution of brightness in the image. The horizontal axis represents the degree of brightness, and the vertical axis, how much of the image is at each level of brightness. Viewing the histogram is a way to check exposure.

Browsing and Filtering Images

Navigating through Images in an Index

By displaying multiple images in an index, you can quickly find the images you are looking for.

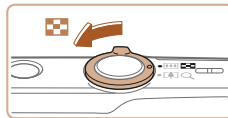

1 Display images in an index.

- Move the zoom lever toward [] to display images in an index. Moving the lever again will increase the number of images shown.
- To display fewer images, move the zoom lever toward [Q]. Fewer images are shown each time you move the lever.



2 Choose an image.

- Press the [▲][▼][◀][▶] buttons to choose an image.
- An orange frame is displayed around the selected image.
- Press the [] button to view the selected image in single-image display.



Finding Images Matching Specified Conditions

Find desired images quickly on a memory card full of images by filtering image display according to your specified conditions. You can also protect (📖61) or delete (📖64) these images all at once.

🕒 Shot Date	Displays the images shot on a specific date.
📷 Still image/Movie	Displays only still images or movies.

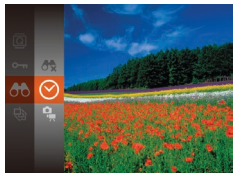

1 Choose the first condition for image display or navigation.

- Press the [📷] button, choose [📷] in the menu, and choose a condition (📖23).

2 Choose the second condition for image display or navigation.

- Press the [▲][▼][◀][▶] buttons to choose a condition, and then press the [📷] button.

3 View the filtered images.

- Images matching your conditions are displayed in yellow frames. To view only these images, press the [◀][▶] buttons.
- To cancel filtered display, choose [📷] in step 1.



- ! When the camera has found no corresponding images for some conditions, those conditions will not be available.



- To show or hide information, press the [▼] button in step 3.
- Options for viewing the images found (in step 3) include "Navigating through Images in an Index" (📖58), "Magnifying Images" (📖60), and "Viewing Slideshows" (📖60). You can protect, erase, or print all images found or add them to a photobook by choosing [Select All Images in Search] in "Protecting Images" (📖61), "Erasing Multiple Images at Once" (📖64), "Adding Images to the Print List (DPOF)" (📖88), or "Adding Images to a Photobook" (📖90).
- If you edit images and save them as new images (📖67 – 68), a message is displayed, and the images that were found are no longer shown.



Image Viewing Options

Still Images

Magnifying Images

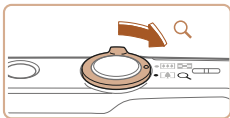

Approximate Position of Displayed Area

1 Magnify an image.

- Moving the zoom lever toward [Q] will zoom in and magnify the image. You can magnify images up to about 10x by continuing to hold the zoom lever.
- To zoom out, move the zoom lever toward [Q]. You can return to single-image display by continuing to hold it.

2 Move the display position and switch images as needed.

- To move the display position, press the [▲][▼][◀][▶] buttons.
- While [SET] is displayed, you can switch to [SET] by pressing the [INFO] button. To switch to other images while zoomed, press the [◀][▶] buttons. Press the [INFO] button again to restore the original setting.



- You can return to single-image display from magnified display by pressing the [MENU] button.

Still Images

Movies

Viewing Slideshows

Automatically play back images from a memory card as follows. Each image is displayed for about three seconds.



- Press the [INFO] button, choose [] in the menu, and choose the desired option (23).
- The slideshow will start after [Loading image] is displayed for a few seconds.
- Press the [MENU] button to stop the slideshow.



- The camera's power-saving functions (21) are deactivated during slideshows.



- To pause or resume slideshows, press the [INFO] button.
- You can switch to other images during playback by pressing the [◀][▶] buttons. For fast-forward or fast-rewind, hold the [◀][▶] buttons down.
- In filtered display (59), only images matching search conditions are played.

Before Use

Basic Guide

Advanced Guide

Camera Basics

Auto Mode

Other Shooting Modes

P Mode

Playback Mode

Setting Menu

Accessories

Appendix

Index



Changing Slideshow Settings

You can set up slideshows to repeat, and you can change the transitions between images and the display duration of each image.



1 Access the setting screen.

- Press the [MENU] button, and then choose [Slideshow] on the [▶] tab (📖24).

2 Configure the settings.

- Choose a menu item to configure, and then choose the desired option (📖24).
- To start the slideshow with your settings, choose [Start] and press the [⏻] button.
- To return to the menu screen, press the [MENU] button.

Protecting Images

Protect important images to prevent accidental erasure (📖64).



- Press the [⏻] button, and then choose [🔒] in the menu (📖23). [Protected] is displayed.
- To cancel protection, repeat this process and choose [🔑] again, and then press the [⏻] button.

! • Protected images on a memory card will be erased if you format the card (📖73).

✎ • Protected images cannot be erased using the camera's erasure function. To erase them this way, first cancel protection.

Before Use

Basic Guide

Advanced Guide

Camera Basics

Auto Mode

Other Shooting Modes

P Mode

Playback Mode

Setting Menu

Accessories

Appendix

Index



Using the Menu

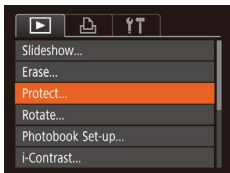

1 Access the setting screen.

- Press the [MENU] button and choose [Protect] on the [▶] tab (📖24).

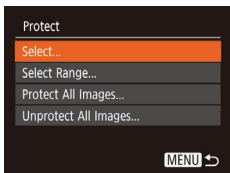

2 Choose a selection method.

- Choose a menu item and an option as desired (📖24).
- To return to the menu screen, press the [MENU] button.



3 Protect the image.

- Press the [MENU] button. A confirmation message is displayed.
- Press the [◀][▶] buttons to choose [OK], and then press the [⏏] button.

- ! Images will not be protected if you switch to Shooting mode or turn the camera off before finishing the setup process in step 3.

Selecting a Range

1 Choose [Select Range].

- Following step 2 in “Using the Menu” (📖62), choose [Select Range] and press the [⏏] button.

2 Choose a starting image.

- Press the [⏏] button.

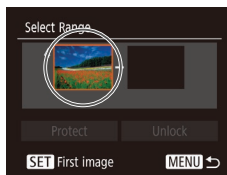

- Press the [◀][▶] buttons to choose an image, and then press the [⏏] button.

Choosing Images Individually

1 Choose [Select].

- Following step 2 in “Using the Menu” (📖62), choose [Select] and press the [⏏] button.

2 Choose an image.

- Press the [◀][▶] buttons to choose an image, and then press the [⏏] button. [OK] is displayed.
- To cancel selection, press the [⏏] button again. [OK] is no longer displayed.
- Repeat this process to specify other images.



Before Use

Basic Guide

Advanced Guide

Camera Basics

Auto Mode

Other Shooting Modes

P Mode

Playback Mode

Setting Menu

Accessories

Appendix

Index



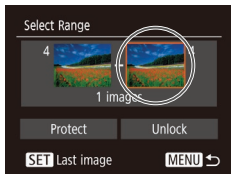

3 Choose an ending image.

- Press the [▶] button to choose [Last image], and then press the [Ⓜ] button.



- Press the [◀][▶] buttons to choose an image, and then press the [Ⓜ] button.
- Images before the first image cannot be selected as the last image.

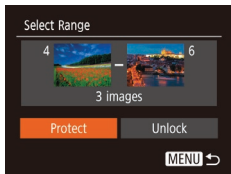

4 Protect the images.

- Press the [▼] button to choose [Protect], and then press the [Ⓜ] button.

Protecting All Images at Once

1 Choose [Protect All Images].

- Following step 2 in “Using the Menu” (62), choose [Protect All Images] and press the [Ⓜ] button.

2 Protect the images.

- Press the [◀][▶] buttons to choose [OK], and then press the [Ⓜ] button.

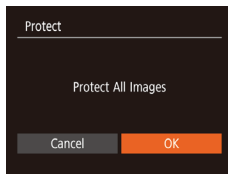

- To cancel protection for groups of images, choose [Unprotect All Images] in step 1.



- To cancel protection for groups of images, choose [Unlock] in step 4.

Before Use

Basic Guide

Advanced Guide

Camera Basics

Auto Mode

Other Shooting Modes

P Mode

Playback Mode

Setting Menu

Accessories

Appendix

Index



Erasing Images

You can choose and erase unneeded images one by one. Be careful when erasing images, because they cannot be recovered. However, protected images (📖61) cannot be erased.

1 Choose an image to erase.

- Press the [◀][▶] buttons to choose an image.

2 Erase the image.

- Press the [🗑️] button.
- After [Erase?] is displayed, press the [◀][▶] buttons to choose [Erase], and then press the [⏏] button.
- The current image is now erased.
- To cancel erasure, press the [◀][▶] buttons to choose [Cancel], and then press the [⏏] button.



Erasing Multiple Images at Once

You can choose multiple images to erase at once. Be careful when erasing images, because they cannot be recovered. However, protected images (📖61) cannot be erased.

Choosing a Selection Method

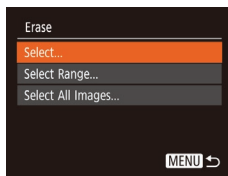
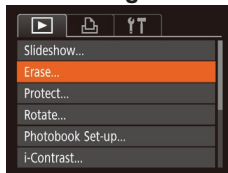

1 Access the setting screen.

- Press the [MENU] button, and then choose [Erase] on the [▶] tab (📖24).

2 Choose a selection method.

- Press the [▲][▼] buttons to choose a selection method, and then press the [⏏] button.
- To return to the menu screen, press the [MENU] button.

Before Use

Basic Guide

Advanced Guide

Camera Basics

Auto Mode

Other Shooting Modes

P Mode

Playback Mode

Setting Menu

Accessories

Appendix

Index



Choosing Images Individually

1 Choose [Select].

- Following step 2 in “Choosing a Selection Method” (📖64), choose [Select] and press the $\left[\text{INFO}\right]$ button.

2 Choose an image.

- Once you choose an image following step 2 in “Choosing Images Individually” (📖62), $\left[\checkmark\right]$ is displayed.
- To cancel selection, press the $\left[\text{INFO}\right]$ button again. $\left[\checkmark\right]$ is no longer displayed.
- Repeat this process to specify other images.

3 Erase the images.

- Press the $\left[\text{MENU}\right]$ button. A confirmation message is displayed.
- Press the $\left[\leftarrow\right]\left[\rightarrow\right]$ buttons to choose [OK], and then press the $\left[\text{INFO}\right]$ button.



Selecting a Range

1 Choose [Select Range].

- Following step 2 in “Choosing a Selection Method” (📖64), choose [Select Range] and press the $\left[\text{INFO}\right]$ button.

2 Choose images.

- Follow steps 2 – 3 in “Selecting a Range” (📖62) to specify images.

3 Erase the images.

- Press the $\left[\blacktriangledown\right]$ button to choose [Erase], and then press the $\left[\text{INFO}\right]$ button.

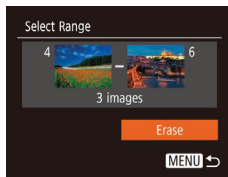

Specifying All Images at Once

1 Choose [Select All Images].

- Following step 2 in “Choosing a Selection Method” (📖64), choose [Select All Images] and press the $\left[\text{INFO}\right]$ button.

2 Erase the images.

- Press the $\left[\leftarrow\right]\left[\rightarrow\right]$ buttons to choose [OK], and then press the $\left[\text{INFO}\right]$ button.

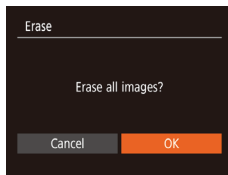

Before Use

Basic Guide

Advanced Guide

Camera Basics

Auto Mode

Other Shooting Modes

P Mode

Playback Mode

Setting Menu

Accessories

Appendix

Index



Rotating Images

Change the orientation of images and save them as follows.



1 Choose [Rotate].

- Press the **[MENU]** button, and then choose **[Rotate]** in the menu ([p23](#)).



2 Rotate the image.

- Press the **[◀]** or **[▶]** button, depending on the desired direction. Each time you press the button, the image is rotated 90°. Press the **[MENU]** button to complete the setting.

Using the Menu

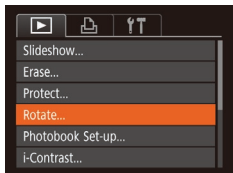

1 Choose [Rotate].

- Press the **[MENU]** button and choose **[Rotate]** on the **[▶]** tab ([p24](#)).



2 Rotate the image.

- Press the **[◀]** or **[▶]** buttons to choose an image.
- The image is rotated 90° each time you press the **[MENU]** button.
- To return to the menu screen, press the **[MENU]** button.

! • Rotation is not possible when [Auto Rotate] is set to [Off] ([p66](#)).

Deactivating Auto Rotation

Follow these steps to deactivate automatic image rotation, which rotates images based on the current camera orientation.



- Press the **[MENU]** button, choose [Auto Rotate] on the **[▶]** tab, and then choose [Off] ([p24](#)).

! • Images cannot be rotated ([p66](#)) when you set [Auto Rotate] to [Off]. Additionally, images already rotated will be displayed in the original orientation.

Before Use

Basic Guide

Advanced Guide

Camera Basics

Auto Mode

Other Shooting Modes

P Mode

Playback Mode

Setting Menu

Accessories

Appendix

Index



Editing Still Images

- Image editing (67 – 68) is only available when the memory card has sufficient free space.

Resizing Images

Still Images

Save a copy of images at a lower number of recording pixels.

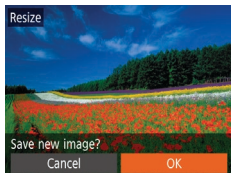
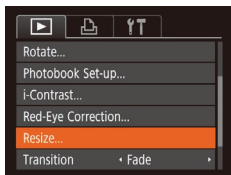

1 Choose [Resize].

- Press the [MENU] button and choose [Resize] on the [] tab (24).

2 Choose an image.

- Press the [][] buttons to choose an image, and then press the [] button.

3 Choose an image size.

- Press the [][] buttons to choose the size, and then press the [] button.
- [Save new image?] is displayed.

4 Save the new image.

- Press the [][] buttons to choose [OK], and then press the [] button.
- The image is now saved as a new file.

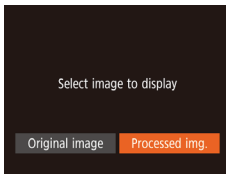

5 Review the new image.

- Press the [MENU] button. [Select image to display] is displayed.
- Press the [][] buttons to choose [Processed img.], and then press the [] button.
- The saved image is now displayed.

- Editing is not possible for images shot at a recording pixel setting of [S] or [W] (36).

- Images cannot be resized to a higher number of recording pixels.

Still Images

Correcting Image Brightness (i-Contrast)

Excessively dark image areas (such as faces or backgrounds) can be detected and automatically adjusted to the optimal brightness. Insufficient overall image contrast is also automatically corrected, to make subjects stand out better. Choose from four correction levels, and then save the image as a separate file.

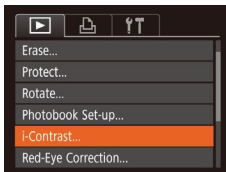

1 Choose [i-Contrast].

- Press the [MENU] button, and then choose [i-Contrast] on the [] tab (24).

2 Choose an image.

- Press the [][] buttons to choose an image, and then press the [] button.

Before Use

Basic Guide

Advanced Guide

Camera Basics

Auto Mode

Other Shooting Modes

P Mode

Playback Mode

Setting Menu

Accessories

Appendix

Index





3 Choose an option.

- Press the [◀][▶] buttons to choose an option, and then press the [OK] button.

4 Save as a new image and review.

- Follow steps 4 – 5 in “Resizing Images” (📖67).



- For some images, correction may be inaccurate or may cause images to appear grainy.
- Images may look grainy after repeated editing using this function.



- If [Auto] does not produce the expected results, try correcting images using [Low], [Medium], or [High].

Still Images

Correcting Red-Eye

Automatically corrects images affected by red-eye. You can save the corrected image as a separate file.

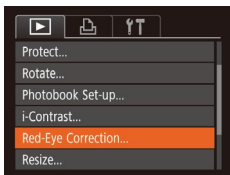

1 Choose [Red-Eye Correction].

- Press the [MENU] button, and then choose [Red-Eye Correction] on the [▶] tab (📖24).

2 Choose an image.

- Press the [◀][▶] buttons to choose an image.



- Some images may not be corrected accurately.
- To overwrite the original image with the corrected image, choose [Overwrite] in step 4. In this case, the original image will be erased.
- Protected images cannot be overwritten.

3 Correct the image.

- Press the [OK] button.
- Red-eye detected by the camera is now corrected, and frames are displayed around corrected image areas.
- Enlarge or reduce images as needed. Follow the steps in “Magnifying Images” (📖60).

4 Save as a new image and review.

- Press the [▲][▼][◀][▶] buttons to choose [New File], and then press the [OK] button.
- The image is now saved as a new file.
- Follow step 5 in “Resizing Images” (📖67).

Before Use

Basic Guide

Advanced Guide

Camera Basics

Auto Mode

Other Shooting Modes

P Mode

Playback Mode

Setting Menu

Accessories

Appendix

Index



Setting Menu

Customize or adjust basic camera functions for greater convenience

Adjusting Basic Camera Functions	70	Using Eco Mode.....	71	Checking Certification Logos	75
Silencing Camera Operations	70	Power-Saving Adjustment.....	72	Display Language	75
Adjusting the Volume	70	Screen Brightness.....	73	Adjusting Other Settings	75
Hiding Hints and Tips	70	Hiding the Start-Up Screen	73	Restoring Default Camera Settings.....	76
Date and Time.....	70	Formatting Memory Cards	73		
World Clock.....	71	File Numbering.....	74		
Lens Retraction Timing	71	Date-Based Image Storage.....	75		

Before Use

Basic Guide

Advanced Guide

Camera Basics

Auto Mode

Other Shooting Modes

P Mode

Playback Mode

Setting Menu

Accessories

Appendix

Index



Adjusting Basic Camera Functions

Basic camera functions are configured on the [Y/T] tab of the MENU (📖24). Customize commonly used functions as desired, for greater convenience.

Silencing Camera Operations

Silence camera sounds and movies as follows.

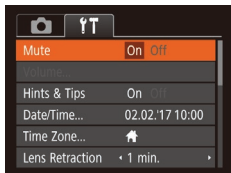

- Choose [Mute], and then choose [On].



- Operation can also be silenced by holding down the [MENU] button as you turn the camera on.
- Sound is not played during movies (📖57) if you mute camera sounds. To restore sound during movies, press the [▲] button. Adjust volume with the [▲][▼] buttons, as needed.

Adjusting the Volume

Adjust the volume of individual camera sounds as follows.

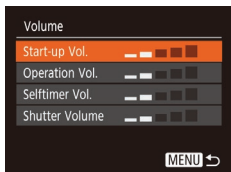

- Choose [Volume], and then press the [🔊] button.
- Choose an item, and then press the [◀][▶] buttons to adjust the volume.

Hiding Hints and Tips

Hints and tips are normally shown when you choose FUNC. (📖23) items. If you prefer, you can deactivate this information.

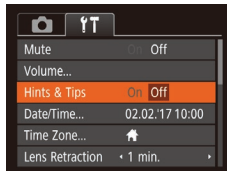

- Choose [Hints & Tips], and then choose [Off].

Date and Time

Adjust the date and time as follows.

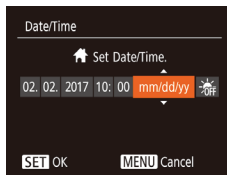

- Choose [Date/Time], and then press the [🕒] button.
- Press the [◀][▶] buttons to choose an option, and then press the [▲][▼] buttons to adjust the setting.

Before Use

Basic Guide

Advanced Guide

Camera Basics

Auto Mode

Other Shooting Modes

P Mode

Playback Mode

Setting Menu

Accessories

Appendix

Index



World Clock

To ensure that your shots will have the correct local date and time when you travel abroad, simply register the destination in advance and switch to that time zone. This convenient feature eliminates the need to change the Date/Time setting manually.

Before using the world clock, be sure to set the date and time and your home time zone, as described in "Setting the Date and Time" (📖13).

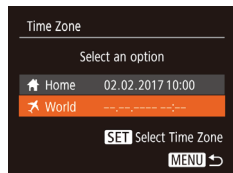

1 Specify your destination.

- Choose [Time Zone], and then press the button.
- Press the buttons to choose [World], and then press the button.
- Press the buttons to choose the destination.
- To set daylight saving time (1 hour ahead), choose by pressing the buttons, and then choose by pressing the buttons.
- Press the button.

2 Switch to the destination time zone.

- Press the buttons to choose [World], and then press the button.
- is now shown on the shooting screen (📖99).

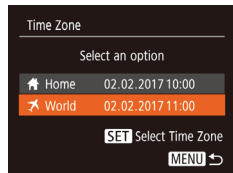

- Adjusting the date or time while in mode (📖14) will automatically update your [Home] time and date.

Lens Retraction Timing

The lens is normally retracted for safety about one minute after you press the button in Shooting mode (📖21). To have the lens retracted immediately after you press the button, set the retraction timing to [0 sec.].

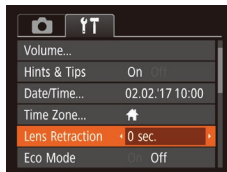

- Choose [Lens Retraction], and then choose [0 sec.].

Using Eco Mode

This function allows you to conserve battery power in Shooting mode. When the camera is not in use, the screen quickly darkens to reduce battery consumption.

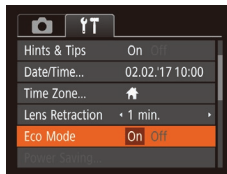

1 Configure the setting.

- Choose [Eco Mode], and then choose [On].
- [ECO] is now shown on the shooting screen (📖99).
- The screen darkens when the camera is not used for approximately two seconds; approximately ten seconds after darkening, the screen turns off. The camera turns off after approximately three minutes of inactivity.

Before Use

Basic Guide

Advanced Guide

Camera Basics

Auto Mode

Other Shooting Modes

P Mode

Playback Mode

Setting Menu

Accessories

Appendix

Index







2 Shoot.

- To activate the screen and prepare for shooting when the screen is off but the lens is still out, press the shutter button halfway.

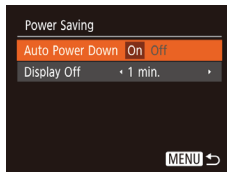
Power-Saving Adjustment

Adjust the timing of automatic camera and screen deactivation (Auto Power Down and Display Off, respectively) as needed (📖21).



- Choose [Power Saving], and then press the  button.
- After choosing an item, press the   buttons to adjust it as needed.

- ⚠️ • To conserve battery power, you should normally choose [On] for [Auto Power Down] and [1 min.] or less for [Display Off].
- ✎ • The [Display Off] setting is applied even if you set [Auto Power Down] to [Off].
- These power-saving functions are not available when you have set Eco mode (📖71) to [On].

Before Use

Basic Guide

Advanced Guide

Camera Basics

Auto Mode

Other Shooting Modes

P Mode

Playback Mode

Setting Menu

Accessories

Appendix

Index



Screen Brightness

Adjust screen brightness as follows.



- Choose [Disp. Brightness], and then press the [◀][▶] buttons to adjust the brightness.



- For maximum brightness, press and hold the [▼] button for at least one second when the shooting screen is displayed or when in single-image display. (This will override the [Disp. Brightness] setting on the [f/T] tab.) To restore the original brightness, press and hold the [▼] button again for at least one second or restart the camera.

Hiding the Start-Up Screen

If you prefer, you can deactivate display of the start-up screen normally shown when you turn the camera on.

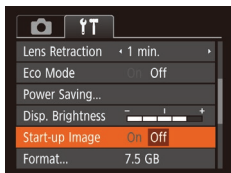

- Choose [Start-up Image], and then choose [Off].

Formatting Memory Cards

Before using a new memory card or a card formatted in another device, you should format the card with this camera.

Formatting erases all data on a memory card. Before formatting, copy images on the memory card to a computer, or take other steps to back them up.

An Eye-Fi card (📖92) contains software on the card itself. Before formatting an Eye-Fi card, install the software on a computer.

1 Access the [Format] screen.

- Choose [Format], and then press the [ⓘ] button.

2 Choose [OK].

- Press the [▲][▼] buttons to choose [Cancel], press the [◀][▶] buttons to choose [OK], and then press the [ⓘ] button.

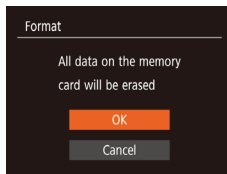
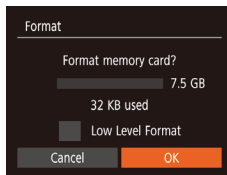

3 Format the memory card.

- To begin the formatting process, press the [▲][▼] buttons to choose [OK], and then press the [ⓘ] button.
- When formatting is finished, [Memory card formatting complete] is displayed. Press the [ⓘ] button.

Before Use

Basic Guide

Advanced Guide

Camera Basics

Auto Mode

Other Shooting Modes

P Mode

Playback Mode

Setting Menu

Accessories

Appendix

Index





- Formatting or erasing data on a memory card only changes file management information on the card and does not erase the data completely. When transferring or disposing of memory cards, take steps to protect personal information if necessary, as by physically destroying cards.



- The total card capacity indicated on the formatting screen may be less than the advertised capacity.

Low-Level Formatting

Perform low-level formatting in the following cases: [Memory card error] is displayed, the camera is not working correctly, card image reading/writing is slower, continuous shooting is slower, or movie recording suddenly stops. Low-level formatting erases all data on a memory card. Before low-level formatting, copy images on the memory card to a computer, or take other steps to back them up.

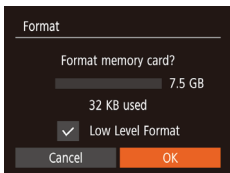

- On the screen in step 2 of “Formatting Memory Cards” (73), press the [▲][▼] buttons to choose [Low Level Format], and then press the [◀][▶] buttons to select this option. A [✓] icon is displayed.
- Follow steps 2 – 3 in “Formatting Memory Cards” (73) to continue with the formatting process.



- Low-level formatting takes longer than “Formatting Memory Cards” (73), because data is erased from all storage regions of the memory card.
- You can cancel low-level formatting in progress by choosing [Stop]. In this case, all data will be erased, but the memory card can be used normally.



File Numbering

Your shots are automatically numbered in sequential order (0001 – 9999) and saved in folders that store up to 2,000 images each. You can change how the camera assigns file numbers.



- Choose [File Numbering], and then choose an option.

Continuous	Images are numbered consecutively (until the 9999th shot is taken/saved) even if you switch memory cards.
Auto Reset	Image numbering is reset to 0001 if you switch memory cards, or when a new folder is created.



- Regardless of the option selected in this setting, shots may be numbered consecutively after the last number of existing images on newly inserted memory cards. To start saving shots from 0001, use an empty (or formatted, 73) memory card.

Before Use

Basic Guide

Advanced Guide

Camera Basics

Auto Mode

Other Shooting Modes

P Mode

Playback Mode

Setting Menu

Accessories

Appendix

Index



Date-Based Image Storage

Instead of saving images in folders created each month, you can have the camera create folders each day you shoot to store shots taken that day.



- Choose [Create Folder], and then choose [Daily].
- Images will now be saved in folders created on the shooting date.

Checking Certification Logos

Some logos for certification requirements met by the camera can be viewed on the screen. Other certification logos are printed in this guide, on the camera packaging, or on the camera body.

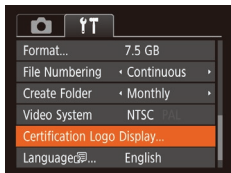

- Choose [Certification Logo Display], and then press the [MENU] button.

Display Language

Change the display language as needed.

English	Norsk	Română
Deutsch	Svenska	Türkçe
Français	Español	العربية
Nederlands	Ελληνικά	ภาษาไทย
Dansk	Русский	简体中文
Português	Polski	繁體中文
Suomi	Čeština	한국어

- Choose [Language], and then press the [MENU] button.
- Press the [▲][▼][◀][▶] buttons to choose a language, and then press the [MENU] button.



- You can also access the [Language] screen in Playback mode by pressing and holding the [MENU] button and immediately pressing the [MENU] button.

Adjusting Other Settings

The following settings can also be adjusted on the [fT] tab.

- [Video System] (81)
- [FlashAir] (92)
- [Eye-Fi Settings] (92)

Before Use

Basic Guide

Advanced Guide

Camera Basics

Auto Mode

Other Shooting Modes

P Mode

Playback Mode

Setting Menu

Accessories

Appendix

Index



Restoring Default Camera Settings

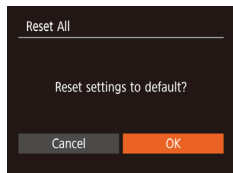

If you accidentally change a setting, you can restore default camera settings.



1 Access the [Reset All] screen.

- Choose [Reset All], and then press the  button.

2 Restore default settings.

- Press the   buttons to choose [OK], and then press the  button.
- Default settings are now restored.



- The following functions are not restored to default settings.
 -  tab settings [Date/Time] (📖70), [Time Zone] (📖71), [Language] (📖75), and [Video System] (📖81)
 - Custom white balance data you have recorded (📖49)
 - Shooting mode (📖39)

Before Use

Basic Guide

Advanced Guide

Camera Basics

Auto Mode

Other Shooting Modes

P Mode

Playback Mode

Setting Menu

Accessories

Appendix

Index



Accessories

Enjoy the camera in more ways with optional Canon accessories and other compatible accessories sold separately

System Map	78	Using the Software	81	Using an Eye-Fi/FlashAir Card	92
Optional Accessories	79	Checking Your Computer Environment	81	Connection Status Display	92
Power Supplies	79	Installing CameraWindow	82	Configuring FlashAir Transfer	93
Flash Unit	79	Saving Images to a Computer.....	82	Checking Eye-Fi Card Connection Information.....	93
Other Accessories	79	Printing Images	84	Disabling Eye-Fi Transfer.....	93
Printers.....	79	Easy Print.....	84		
Photo and Movie Storage.....	80	Configuring Print Settings	85		
Using Optional Accessories	80	Printing Movie Scenes	88		
Playback on a TV	80	Adding Images to the Print List (DPOF).....	88		
		Adding Images to a Photobook.....	90		

Before Use

Basic Guide

Advanced Guide

Camera Basics

Auto Mode

Other Shooting Modes

P Mode

Playback Mode

Setting Menu

Accessories

Appendix

Index



System Map

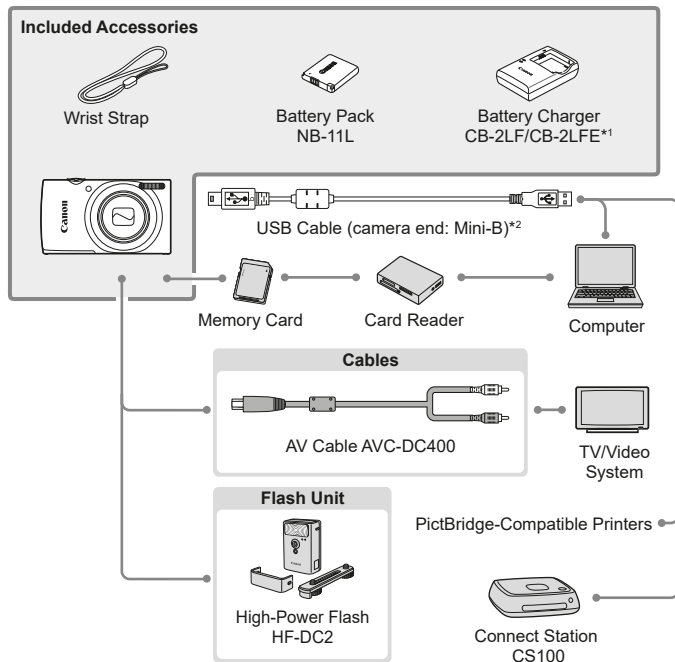

*1 Also available for purchase separately.

*2 A genuine Canon accessory is also available (Interface Cable IFC-400PCU).

Use of genuine Canon accessories is recommended.

This product is designed to achieve excellent performance when used with genuine Canon accessories. Canon shall not be liable for any damage to this product and/or accidents such as fire, etc., caused by the malfunction of non-genuine Canon accessories (e.g., a leakage and/or explosion of a battery pack). Please note that any repairs your Canon product may require as a result of such malfunction are not covered under warranty and will incur a fee.

Before Use

Basic Guide

Advanced Guide

Camera Basics

Auto Mode

Other Shooting Modes

P Mode

Playback Mode

Setting Menu

Accessories

Appendix

Index



Optional Accessories

The following camera accessories are sold separately. Note that availability varies by area, and some accessories may no longer be available.

Power Supplies

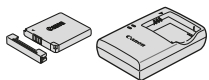

Battery Pack NB-11LH

- Rechargeable lithium-ion battery

Battery Charger CB-2LF/CB-2LFE

- Charger for Battery Pack NB-11LH and NB-11L.



- The battery pack includes a convenient cover which you can attach to know the charge status at a glance. Attach the cover so that ▲ is visible on a charged battery pack, and attach it so that ▲ is not visible on an uncharged battery pack.
- Battery Pack NB-11L is also supported.
- Battery Charger CB-2LD is also supported.



- The battery charger can be used in areas with 100 – 240 V AC power (50/60 Hz).
- For power outlets in a different format, use a commercially available adapter for the plug. Never use an electrical transformer designed for traveling, which may damage the battery pack.

Flash Unit



High-Power Flash HF-DC2

- External flash for illuminating subjects that are out of range of the built-in flash.

Other Accessories

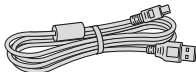

Interface Cable IFC-400PCU

- For connecting the camera to a computer or printer.

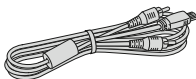

AV Cable AVC-DC400

- Connect the camera to a TV to enjoy playback on the larger TV screen.

Printers



Canon-Brand PictBridge-Compatible Printers

- Even without using a computer, you can print images by connecting the camera directly to a printer.

For details, visit your nearest Canon retailer.

Before Use

Basic Guide

Advanced Guide

Camera Basics

Auto Mode

Other Shooting Modes

P Mode

Playback Mode

Setting Menu

Accessories

Appendix

Index



Photo and Movie Storage



Connect Station CS100

- A media hub for storing camera images, viewing on a connected TV, printing wirelessly on a Wi-Fi-compatible printer, sharing over the Internet, and more.

Using Optional Accessories

Still Images

Movies

Playback on a TV

Still Images

Movies

Connecting the camera to a TV with the AV Cable AVC-DC400 (sold separately) enables you to view your shots on the larger screen of the TV as you control the camera.

For details on connection or how to switch inputs, refer to the TV manual.



- Some information may not be displayed when viewing images on a TV (100).

1 Make sure the camera and TV are off.

2 Connect the camera to the TV.

- On the TV, insert the cable plugs fully into the video inputs as shown.
- On the camera, open the terminal cover and insert the cable plug fully into the camera terminal.

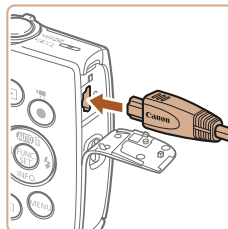
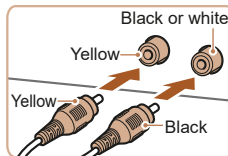

Before Use

Basic Guide

Advanced Guide

Camera Basics

Auto Mode

Other Shooting Modes

P Mode

Playback Mode

Setting Menu

Accessories

Appendix

Index





3 Turn the TV on and switch to video input.

- Switch the TV input to the video input you connected the cable to in step 2.

4 Turn the camera on.

- Press the  button to turn the camera on.
- Images from the camera are now displayed on the TV. (Nothing is displayed on the camera screen.)
- When finished, turn off the camera and TV before disconnecting the cable.

- ! • Correct display is not possible unless the camera video output format (NTSC or PAL) matches the TV format. To change the video output format, press the **[MENU]** button and choose **[Video System]** on the **[P]** tab.

Using the Software

To utilize the features of the following software, download the software from the Canon website and install it on your computer.

- CameraWindow
 - Import images to your computer



- To view and edit images on a computer, use preinstalled or commonly available software compatible with images captured by the camera.

Checking Your Computer Environment

For detailed software system requirements and compatibility information (including support in new operating systems), visit the Canon website.

Before Use

Basic Guide

Advanced Guide

Camera Basics

Auto Mode

Other Shooting Modes

P Mode

Playback Mode

Setting Menu

Accessories

Appendix

Index



Installing CameraWindow

1 Download the software.

- With a computer connected to the Internet, access <http://www.canon.com/icpd/>.
- Choose your country or region, and then follow the instructions displayed to prepare for downloading.

2 Follow the instructions displayed.

- Double-click the downloaded file to install it.



- Internet access is required, and any ISP account charges and access fees must be paid separately.



- To uninstall the software, follow these steps.
 - Windows: Select [Start] menu > [All Programs] > [Canon Utilities], and then choose the software for uninstallation.
 - Mac OS: In the [Canon Utilities] folder within the [Applications] folder, drag the folder of the software for uninstallation to the Trash, and then empty the Trash.

Saving Images to a Computer

Using a USB cable (sold separately; camera end: Mini-B), you can connect the camera to the computer and save images to the computer.

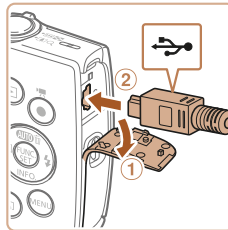

1 Connect the camera to the computer.

- With the camera turned off, open the cover (①). With the smaller plug of the USB cable in the orientation shown, insert the plug fully into the camera terminal (②).

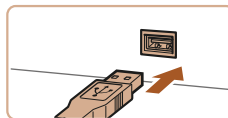

- Insert the larger plug of the USB cable in the computer's USB port. For details about USB connections on the computer, refer to the computer user manual.

Before Use

Basic Guide

Advanced Guide

Camera Basics

Auto Mode

Other Shooting Modes

P Mode

Playback Mode

Setting Menu

Accessories

Appendix

Index





2 Turn the camera on to access CameraWindow.

- Press the button to turn the camera on.
- Mac OS: CameraWindow is displayed when a connection is established between the camera and computer.
- Windows: Follow the steps introduced below.
- In the screen that is displayed, click the change program link of .
- Choose [Downloads Images From Canon Camera] and then click [OK].
- Double-click .

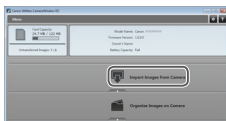
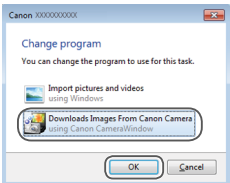

3 Save the images to the computer.

- Click [Import Images from Camera], and then click [Import Untransferred Images].
- Images are now saved to the Pictures folder on the computer, in separate folders named by date.
- After images are saved, close CameraWindow, press the button to turn the camera off, and unplug the cable.
- To view images you save to a computer, use preinstalled or commonly available software compatible with images captured by the camera.

Before Use

Basic Guide

Advanced Guide

Camera Basics

Auto Mode

Other Shooting Modes

P Mode

Playback Mode

Setting Menu

Accessories

Appendix

Index





- Windows 7: If the screen in step 2 is not displayed, click the  icon in the taskbar.
- Mac OS: If CameraWindow is not displayed after step 2, click the [CameraWindow] icon in the Dock.
- Although you can save images to a computer simply by connecting your camera to the computer without using the software, the following limitations apply.
 - It may take a few minutes after you connect the camera to the computer until camera images are accessible.
 - Images shot in vertical orientation may be saved in horizontal orientation.
 - Image protection settings may be cleared from images saved to a computer.
 - Some problems may occur when saving images or image information, depending on the operating system version, the software in use, or image file sizes.

Printing Images

Your shots can easily be printed by connecting the camera to a printer. On the camera, you can specify images to set up batch printing, prepare orders for photo development services, and prepare orders or print images for photobooks.

A Canon SELPHY CP series compact photo printer is used here for the sake of illustration. Screens displayed and available functions vary by printer. Also refer to the printer manual for additional information.

Easy Print

Easily print your shots by connecting the camera to a PictBridge-compatible printer (sold separately) with the USB cable.

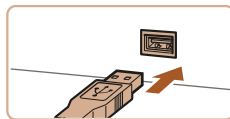
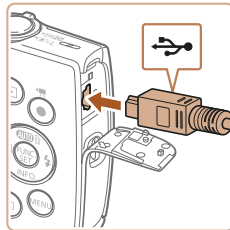

1 Make sure the camera and printer are off.

2 Connect the camera to the printer.

- Open the terminal cover. Holding the smaller cable plug in the orientation shown, insert the plug fully into the camera terminal.
- Connect the larger cable plug to the printer. For other connection details, refer to the printer manual.

Still Images

Movies

Before Use

Basic Guide

Advanced Guide

Camera Basics

Auto Mode

Other Shooting Modes

P Mode

Playback Mode

Setting Menu

Accessories

Appendix

Index





3 Turn the printer on.

4 Turn the camera on.

- Press the button to turn the camera on.

5 Choose an image.

- Press the buttons to choose an image.

6 Access the printing screen.

- Press the button, choose , and press the button again.

7 Print the image.

- Press the buttons to choose [Print], and then press the button.
- Printing now begins.
- To print other images, repeat the above procedures starting from step 5 after printing is finished.
- When you are finished printing, turn the camera and printer off and disconnect the cable.

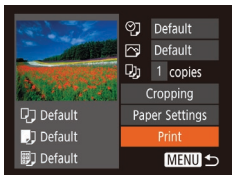

- For Canon-brand PictBridge-compatible printers (sold separately), see "Printers" (86).

Configuring Print Settings

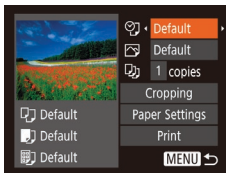

1 Access the printing screen.

- Follow steps 1 – 6 in "Easy Print" (84) to access the screen at left.

2 Configure the settings.

- Press the buttons to choose an item, and then press the buttons to choose an option.

	Default	Matches current printer settings.
	Date	Prints images with the date added.
	File No.	Prints images with the file number added.
	Both	Prints images with both the date and file number added.
	Off	–
	Default	Matches current printer settings.
	Off	–
	On	Uses information from the time of shooting to print under optimal settings.
	Red-Eye 1	Corrects red-eye.
		No. of Copies
Cropping	–	Specify a desired image area to print (86).
Paper Settings	–	Specify the paper size, layout, and other details (86).



Cropping Images before Printing

By cropping images before printing, you can print a desired image area instead of the entire image.

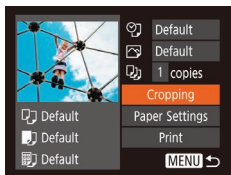

1 Choose [Cropping].

- After following step 1 in “Configuring Print Settings” (85) to access the printing screen, choose [Cropping] and press the $\left[\text{OK}\right]$ button.
- A cropping frame is now displayed, indicating the image area to print.

2 Adjust the cropping frame as needed.

- To resize the frame, move the zoom lever.
- To move the frame, press the $\left[\blacktriangle\right]\left[\blacktriangledown\right]\left[\blacktriangleleft\right]\left[\blacktriangleright\right]$ buttons.
- To rotate the frame, press the $\left[\text{OK}\right]$ button.
- Press the $\left[\text{MENU}\right]$ button, press the $\left[\blacktriangle\right]\left[\blacktriangledown\right]$ buttons to choose [OK], and then press the $\left[\text{OK}\right]$ button.

3 Print the image.

- Follow step 7 in “Easy Print” (85) to print.



- Cropping may not be possible at small image sizes, or at some aspect ratios.
- Dates may not be printed correctly if you crop images shot with date stamping configured.

Choosing Paper Size and Layout before Printing

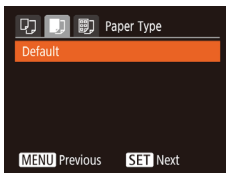
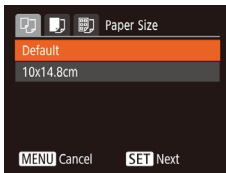
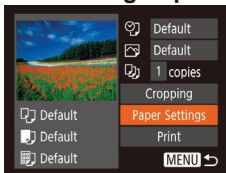

1 Choose [Paper Settings].

- After following step 1 in “Configuring Print Settings” (85) to access the printing screen, choose [Paper Settings] and press the $\left[\text{OK}\right]$ button.

2 Choose a paper size.

- Press the $\left[\blacktriangle\right]\left[\blacktriangledown\right]$ buttons to choose an option, and then press the $\left[\text{OK}\right]$ button.

3 Choose a type of paper.

- Press the $\left[\blacktriangle\right]\left[\blacktriangledown\right]$ buttons to choose an option, and then press the $\left[\text{OK}\right]$ button.



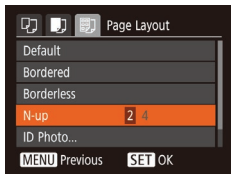

4 Choose a layout.

- Press the [▲][▼] buttons to choose an option.
- When choosing [N-up], press the [◀][▶] buttons to specify the number of images per sheet.
- Press the [⊞] button.

5 Print the image.

Available Layout Options

Default	Matches current printer settings.
Bordered	Prints with blank space around the image.
Borderless	Borderless, edge-to-edge printing.
N-up	Choose how many images to print per sheet.
ID Photo	Prints images for identification purposes. Only available for images with a recording pixel setting of L.
Fixed Size	Choose the print size. Choose from 3.5 x 5 in., postcard, or wide-format prints.

Still Images

Printing ID Photos

1 Choose [ID Photo].

- Following steps 1 – 4 in “Choosing Paper Size and Layout before Printing” (86), choose [ID Photo] and press the [⊞] button.

2 Choose the long and short side length.

- Press the [▲][▼] buttons to choose an item. Choose the length by pressing the [◀][▶] buttons, and then press the [⊞] button.

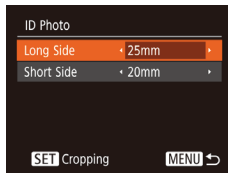

Before Use

Basic Guide

Advanced Guide

Camera Basics

Auto Mode

Other Shooting Modes

P Mode

Playback Mode

Setting Menu

Accessories

Appendix

Index



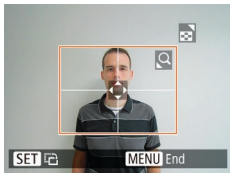

3 Choose the printing area.

- Follow step 2 in “Cropping Images before Printing” (📖86) to choose the printing area.

4 Print the image.

Movies

Printing Movie Scenes

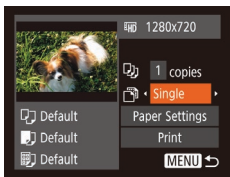

1 Access the printing screen.

- Follow steps 1 – 6 in “Easy Print” (📖84) to choose a movie. The screen at left is displayed.

2 Choose a printing method.

- Press the [▲][▼] buttons to choose [🖨️], and then press the [◀][▶] buttons to choose the printing method.

3 Print the image.

Movie Printing Options

Single	Prints the current scene as a still image.
Sequence	Prints a series of scenes, a certain interval apart, on a single sheet of paper. You can also print the folder number, file number, and elapsed time for the frame by setting [Caption] to [On].



- To cancel printing in progress, press the [🖨️] button, choose [OK], and then press the [🖨️] button again.
- After displaying a scene to print as described in steps 2 – 5 of “Viewing” (📖57), you can also access the screen in step 1 here by pressing the [◀][▶] buttons to choose [🖨️] in the movie control panel and then pressing the [🖨️] button.

Still Images

Adding Images to the Print List (DPOF)

Batch printing (📖90) and ordering prints from a photo development service can be set up on the camera. Choose up to 998 images on a memory card and configure relevant settings, such as the number of copies, as follows. The printing information you prepare this way will conform to DPOF (Digital Print Order Format) standards.

Still Images

Configuring Print Settings

Specify the printing format, whether to add the date or file number, and other settings as follows. These settings apply to all images in the print list.

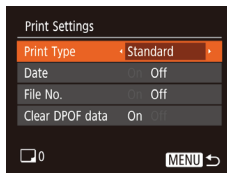

- Press the [MENU] button, and then choose [Print Settings] on the [🖨️] tab. Choose and configure items as desired (📖24).

Before Use

Basic Guide

Advanced Guide

Camera Basics

Auto Mode

Other Shooting Modes

P Mode

Playback Mode

Setting Menu

Accessories

Appendix

Index



Print Type	Standard	One image is printed per sheet.
	Index	Smaller versions of multiple images are printed per sheet.
	Both	Both standard and index formats are printed.
Date	On	Images are printed with the shooting date.
	Off	–
File No.	On	Images are printed with the file number.
	Off	–
Clear DPOF data	On	All image print list settings are cleared after printing.
	Off	–

- ⚠ Not all of your DPOF settings may be applied in printing by the printer or photo development service, in some cases.
- ⚠ may be displayed on the camera to warn you that the memory card has print settings that were configured on another camera. Changing the print settings using this camera may overwrite all previous settings.
- Setting [Date] to [On] may cause some printers to print the date twice.



- Specifying [Index] will prevent you from choosing [On] for both [Date] and [File No.] at the same time.
- Index printing is not available on some Canon-brand PictBridge-compatible printers (sold separately).
- The date is printed in a format matching setting details in [Date/Time] on the [↑↓] tab (13).

Setting Up Printing for Individual Images

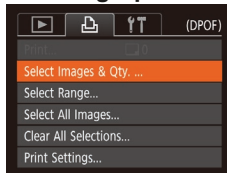

1 Choose [Select Images & Qty.].

- Press the [MENU] button, choose [Select Images & Qty.] on the [🖨] tab, and then press the [OK] button.

2 Choose an image.

- Press the [◀][▶] buttons to choose an image, and then press the [OK] button.
- You can now specify the number of copies.
- If you specify index printing for the image, it is labeled with a [✓] icon. To cancel index printing for the image, press the [OK] button again. [✓] is no longer displayed.

3 Specify the number of prints.

- Press the [▲][▼] buttons to specify the number of prints (up to 99).
- To set up printing for other images and specify the number of prints, repeat steps 2 – 3.
- Printing quantity cannot be specified for index prints. You can only choose which images to print, by following step 2.
- When finished, press the [MENU] button to return to the menu screen.



Setting Up Printing for a Range of Images

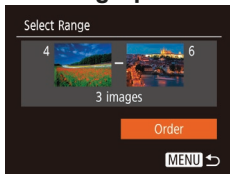

- Following step 1 in “Setting Up Printing for Individual Images” (89), choose [Select Range] and press the [OK] button.
- Follow steps 2 – 3 in “Selecting a Range” (62) to specify images.
- Press the [▲] / [▼] buttons to choose [Order], and then press the [OK] button.

Setting Up Printing for All Images

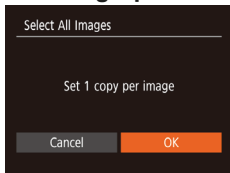

- Following step 1 in “Setting Up Printing for Individual Images” (89), choose [Select All Images] and press the [OK] button.
- Press the [◀] / [▶] buttons to choose [OK], and then press the [OK] button.

Clearing All Images from the Print List

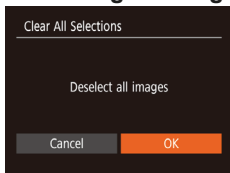

- Following step 1 in “Setting Up Printing for Individual Images” (89), choose [Clear All Selections] and press the [OK] button.
- Press the [◀] / [▶] buttons to choose [OK], and then press the [OK] button.

Printing Images Added to the Print List (DPOF)

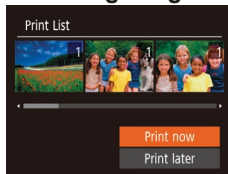

- When images have been added to the print list (88 – 90), the screen at left is displayed after you connect the camera to a PictBridge-compatible printer. Press the [▲] / [▼] buttons to choose [Print now], and then simply press the [OK] button to print the images in the print list.
- Any DPOF print job that you temporarily stop will be resumed from the next image.

Adding Images to a Photobook

Photobooks can be set up on the camera by choosing up to 998 images on a memory card and transferring them into the software on your computer, where they are stored in their own folder. This is convenient when ordering printed photobooks online or printing photobooks with your own printer.

Choosing a Selection Method

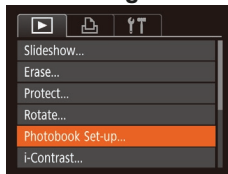

- Press the [MENU] button, choose [Photobook Set-up] on the [▶] tab, and then choose how you will select images.



- [!] may be displayed on the camera to warn you that the memory card has print settings that were configured on another camera. Changing the print settings using this camera may overwrite all previous settings.



Adding Images Individually

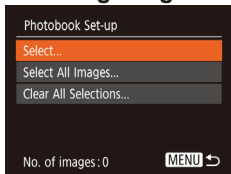

1 Choose [Select].

- Following the procedure in “Choosing a Selection Method” (90), choose [Select] and press the $\left(\frac{\text{OK}}{\text{MENU}}\right)$ button.

2 Choose an image.

- Press the $\left[\left\langle\right\rangle\right]$ buttons to choose an image, and then press the $\left(\frac{\text{OK}}{\text{MENU}}\right)$ button.
- $\left[\checkmark\right]$ is displayed.
- To remove the image from the photobook, press the $\left(\frac{\text{OK}}{\text{MENU}}\right)$ button again. $\left[\checkmark\right]$ is no longer displayed.
- Repeat this process to specify other images.
- When finished, press the $\left[\text{MENU}\right]$ button to return to the menu screen.



Adding All Images to a Photobook

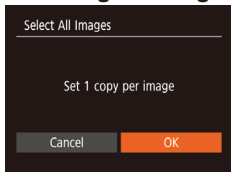

- Following the procedure in “Choosing a Selection Method” (90), choose [Select All Images] and press the $\left(\frac{\text{OK}}{\text{MENU}}\right)$ button.
- Press the $\left[\left\langle\right\rangle\right]$ buttons to choose [OK], and then press the $\left(\frac{\text{OK}}{\text{MENU}}\right)$ button.

Removing All Images from a Photobook

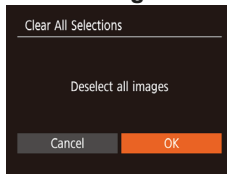

- Following the procedure in “Choosing a Selection Method” (90), choose [Clear All Selections] and press the $\left(\frac{\text{OK}}{\text{MENU}}\right)$ button.
- Press the $\left[\left\langle\right\rangle\right]$ buttons to choose [OK], and then press the $\left(\frac{\text{OK}}{\text{MENU}}\right)$ button.



Using an Eye-Fi/FlashAir Card

Before using an Eye-Fi/FlashAir card, always confirm that local use is permitted.

You can send images from the camera to Wi-Fi compatible smartphones, tablets, or computers by inserting a FlashAir card in the camera. Inserting a prepared Eye-Fi card enables automatic wireless transfer of images to a computer or uploading to a photo-sharing website.

Images are transferred by the Eye-Fi/FlashAir card. Refer to the card's user manual or contact the manufacturer for instructions on preparing and using cards or resolving transfer problems.



- When using an Eye-Fi/FlashAir card, keep the following points in mind.
 - Cards may continue to emit radio waves even after [FlashAir] is set to [Off] (📖93) or [Eye-Fi trans.] is set to [Disable] (📖93). Remove the card before entering hospitals, aircraft, or other areas where transmission is prohibited.
 - When troubleshooting image transfer issues, check the card and computer settings. For details, refer to the card's user manual.
 - Poor network connections may delay or interrupt image transfer.
 - Cards may become hot, due to their transfer functions.
 - Battery power will be consumed faster than in normal use.
 - Camera operation may become sluggish. To resolve this, try setting [Eye-Fi trans.] to [Disable].

Connection Status Display

Connection status can be checked on the shooting screen (in regular information display mode) or playback screen (in simple information display mode).

With a FlashAir Card in the Camera

 On*1	 Off
 Starting up	 Shutting down
 Transmission control error*2	

*1 Power saving on the camera is disabled while the card is on.

*2 Restart the camera. Repeated display of this icon may indicate a problem with the card.

With an Eye-Fi Card in the Camera

 (Gray)	Disconnected	 Interrupted
 (Blinking white)	Connecting	 Not communicating
 (White)	Connected	 Error acquiring Eye-Fi card information*2
 (Animated)	Transfer in progress*1	

*1 Power saving (📖21) on the camera is temporarily disabled during image transfer.

*2 Restart the camera. Repeated display of this icon may indicate a problem with the card.

Images labeled with a  icon have been transferred.



Configuring FlashAir Transfer

Enable transfer using the FlashAir card.

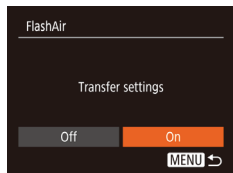

- Press the [MENU] button, choose [FlashAir] on the [F1] tab, and then press the [OK] button.
- Press the [◀][▶] buttons to choose [On], and then press the [OK] button.

! • [FlashAir] is not displayed unless a FlashAir card is in the camera.

Checking Eye-Fi Card Connection Information

Check the access point SSID used by the Eye-Fi card or the connection status, as needed.

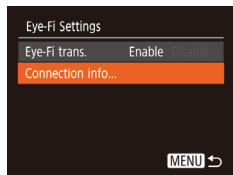

- Press the [MENU] button, choose [Eye-Fi Settings] on the [F1] tab, and then press the [OK] button.
- Choose [Connection info], and then press the [OK] button.
- The connection information screen is displayed.

Disabling Eye-Fi Transfer

Configure the setting as follows to disable Eye-Fi transfer by the card, if necessary.

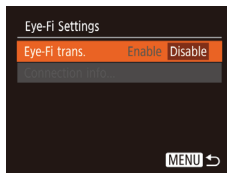

- Press the [MENU] button, choose [Eye-Fi Settings] on the [F1] tab, and then press the [OK] button.
- Choose [Eye-Fi trans.], and then choose [Disable].

! • [Eye-Fi Settings] is not shown unless an Eye-Fi card is in the camera with its write-protect tab in the unlocked position. For this reason, you cannot change settings for an inserted Eye-Fi card if the write-protect tab is in the locked position.

Before Use

Basic Guide

Advanced Guide

Camera Basics

Auto Mode

Other Shooting Modes

P Mode

Playback Mode

Setting Menu

Accessories

Appendix

Index



Appendix

Helpful information when using the camera

Troubleshooting	95	Functions and Menu Tables	101	Handling Precautions	107
On-Screen Messages	97	Functions Available in Each Shooting Mode	101	Specifications	107
On-Screen Information	99	FUNC. Menu	102		
Shooting (Information Display)	99	📷 Shooting Tab	104		
Playback (Detailed Information Display)	100	⚙️ Set Up Tab	106		
		▶️ Playback Tab	106		
		🖨️ Print Tab	106		
		Playback Mode FUNC. Menu	106		

Before Use

Basic Guide

Advanced Guide

Camera Basics

Auto Mode

Other Shooting Modes

P Mode

Playback Mode

Setting Menu

Accessories

Appendix

Index



Troubleshooting

If you think there is a problem with the camera, first check the following. If the items below do not solve your problem, contact a Canon Customer Support Help Desk.

Power

Nothing happens when the ON/OFF button is pressed.

- Confirm that the battery pack is charged (📖11).
- Confirm that the battery pack is inserted facing the correct way (📖12).
- Confirm that the memory card/battery cover is fully closed (📖12).
- Dirty battery terminals reduce battery performance. Try cleaning the terminals with a cotton swab and reinserting the battery pack a few times.

The battery pack runs out of power quickly.

- Battery performance decreases at low temperatures. Try warming the battery pack a little by putting it in your pocket, for example, ensuring that the terminals do not touch any metal objects.
- If these measures do not help and the battery pack still runs out of power soon after charging, it has reached the end of its life. Purchase a new battery pack.

The lens is not retracted.

- Do not open the memory card/battery cover while the camera is on. Close the cover, turn the camera on, and then turn it off again (📖12).

The battery pack is swollen.

- Battery swelling is normal and does not pose any safety concerns. However, if battery swelling prevents the battery pack from fitting in the camera, contact a Canon Customer Support Help Desk.

Display on a TV

Camera images look distorted or are not displayed on a TV (📖81).

Shooting

Cannot shoot.

- In Playback mode (📖56), press the shutter button halfway (📖22).

Strange display on the screen under low light (📖22).

Strange display on the screen when shooting.

Note that the following display problems are not recorded in still images but are recorded in movies.

- The screen may darken under bright light.
- The screen may flicker under fluorescent or LED lighting.
- Purplish banding may appear on the screen if you compose a shot that includes a bright light source.

No date stamp is added to images.

- By itself, the [Date/Time] setting (📖13) does not add date stamps to images. Configure the [Date Stamp] setting (📖32).
- Date stamps are not added in shooting modes (📖101) in which date stamping cannot be configured (📖32).

[📷] flashes on the screen when the shutter button is pressed, and shooting is not possible (📖29).

[📷] is displayed when the shutter button is pressed halfway (📖29).

- Set the flash mode to [📷] (📖53).
- Increase the ISO speed (📖47).
- Mount the camera on a tripod or take other measures to keep it still.

Shots are out of focus.

- Press the shutter button halfway to focus on subjects before pressing it all the way down to shoot (📖22).
- Make sure subjects are within focusing range (📖107).
- Set [Lamp Setting] to [On] (📖37).
- Confirm that unneeded functions such as macro are deactivated.
- Try shooting with focus lock (📖51).

No AF frames are displayed and the camera does not focus when the shutter button is pressed halfway.

- To have AF frames displayed and the camera focus correctly, try composing the shot with higher-contrast subject areas centered before you press the shutter button halfway. Otherwise, try pressing the shutter button halfway repeatedly.

Before Use

Basic Guide

Advanced Guide

Camera Basics

Auto Mode

Other Shooting Modes

P Mode

Playback Mode

Setting Menu

Accessories

Appendix

Index



Subjects in shots look too dark.

- Set the flash mode to [F] (📖53).
- Adjust brightness by using exposure compensation (📖46).
- Adjust contrast by using i-Contrast (📖48, 67).
- Use spot metering (📖47).

Subjects look too bright, highlights are washed-out.

- Set the flash mode to [S] (📖35).
- Adjust brightness by using exposure compensation (📖46).
- Use spot metering (📖47).
- Reduce the lighting on subjects.

Shots look too dark despite the flash firing (📖29).

- Shoot within flash range (📖108).
- Increase the ISO speed (📖47).

Subjects in flash shots look too bright, highlights are washed-out.

- Shoot within flash range (📖108).
- Set the flash mode to [S] (📖35).

White spots appear in flash shots.

- This is caused by light from the flash reflecting off dust or airborne particles.

Shots look grainy.

- Lower the ISO speed (📖47).
- High ISO speeds in some shooting modes may cause grainy images (📖47).

Subjects are affected by red-eye.

- Set [Lamp Setting] to [On] (📖37) to light the red-eye reduction lamp (📖4) for flash shots. Note that while the red-eye reduction lamp is lit (for about one second), it is not possible to shoot, because the lamp is counteracting red-eye. For best results, have subjects look at the red-eye reduction lamp. Also try increasing the lighting in indoor scenes and shooting at closer range.
- Edit images using red-eye correction (📖68).

Recording to the memory card takes too long, or continuous shooting is slower.

- Use the camera to perform low-level formatting of the memory card (📖74).

Shooting settings or FUNC. menu settings are not available.

- Available setting items vary by shooting mode. Refer to “Functions Available in Each Shooting Mode”, “FUNC. Menu”, and “Shooting Tab” (📖101 – 105).

Shooting Movies

The elapsed time shown is incorrect, or recording is interrupted.

- Use the camera to format the memory card, or switch to a card that supports high-speed recording. Note that even if the elapsed time display is incorrect, the length of movies on the memory card corresponds to the actual recording time (📖73, 108).

[🔴] is displayed and shooting stops automatically.

The camera’s internal memory buffer filled up as the camera could not record to the memory card quickly enough. Try one of the following measures.

- Use the camera to perform low-level formatting of the memory card (📖74).
- Lower the image quality (📖36).
- Switch to a memory card that supports high-speed recording (📖108).

Playback

Playback is not possible.

- Image or movie playback may not be possible if a computer is used to rename files or alter the folder structure.

Playback stops, or audio skips.

- Switch to a memory card that you have performed low-level formatting on with the camera (📖74).
- There may be brief interruptions when playing movies copied to memory cards that have slow read speeds.
- When movies are played on a computer, frames may be dropped and audio may skip if computer performance is inadequate.

Sound is not played during movies.

- Adjust the volume (📖57) if you have activated [Mute] (📖70) or the sound in the movie is faint.

Before Use

Basic Guide

Advanced Guide

Camera Basics

Auto Mode

Other Shooting Modes

P Mode

Playback Mode

Setting Menu

Accessories

Appendix

Index



Memory Card

The memory card is not recognized.

- Restart the camera, with the memory card in it (📖21).

Computer

Cannot transfer images to a computer.

When attempting to transfer images to the computer via a cable, try reducing the transfer speed as follows.

- Press the [▶] button to enter Playback mode. Hold the [MENU] button down as you press the [▲] and [⊕] buttons at the same time. On the next screen, press the [◀][▶] buttons to choose [B], and then press the [⊕] button.

Eye-Fi/FlashAir Card

Cannot transfer images (📖92).

On-Screen Messages

If an error message is displayed, respond as follows.

Shooting or Playback

No memory card

- The memory card may be inserted facing the wrong way. Reinsert the memory card facing the correct way (📖12).

Memory card locked

- The write-protect switch of the memory card is set to the locked position. Switch the write-protect switch to the unlocked position (📖12).

Cannot record!

- Shooting was attempted without a memory card in the camera. To shoot, insert a memory card facing the correct way (📖12).

Memory card error (📖74)

- If the same error message is displayed even after you have formatted a supported memory card (📖2) and have inserted it facing the correct way (📖12), contact a Canon Customer Support Help Desk.

Insufficient space on card

- There is not enough free space on the memory card to shoot (📖26, 38, 45) or edit images (📖67 – 68). Either erase unneeded images (📖64) or insert a memory card with enough free space (📖12).

Charge the battery (📖11)

No Image.

- The memory card does not contain any images that can be displayed.

Protected! (📖61)

Unidentified Image/Incompatible JPEG/Image too large./Cannot play back MOV/Cannot play back MP4

- Unsupported or corrupt images cannot be displayed.
- It may not be possible to display images that were edited or renamed on a computer, or images shot with another camera.

Before Use

Basic Guide

Advanced Guide

Camera Basics

Auto Mode

Other Shooting Modes

P Mode

Playback Mode

Setting Menu

Accessories

Appendix

Index



Cannot magnify!/Cannot rotate/Cannot modify image/Cannot modify/Unselectable image.

- The following functions may be unavailable for images that were renamed or already edited on a computer, or images shot with another camera. Note that starred (*) functions are not available for movies.
Magnify* (📖60), Rotate* (📖66), Edit* (📖67 – 68), Print List* (📖88), and Photobook Set-up* (📖90).

Exceeded selection limit

- More than 998 images were selected for Print List (📖88) or Photobook Set-up (📖90). Choose 998 images or less.
- Print List (📖88) or Photobook Set-up (📖90) settings could not be saved correctly. Reduce the number of selected images and try again.
- You attempted to choose more than 500 images in Protect (📖61), Erase (📖64), Print List (📖88), or Photobook Set-up (📖90).

Naming error!

- The folder could not be created or images could not be recorded, because the highest supported folder number (999) for storing images on the card has been reached and the highest supported image number (9999) for images in folders has been reached. On the [📁] tab, change [File Numbering] to [Auto Reset] (📖74), or format the memory card (📖73).

Lens Error

- This error may occur if the lens is held while it is moving, or when the camera is used in dusty or sandy locations.
- Frequent display of this error message may indicate camera damage. In this case, contact a Canon Customer Support Help Desk.

A camera error was detected (error number)

- If this error message is displayed immediately after a shot, the image may not have been saved. Switch to Playback mode to check for the image.
- Frequent display of this error message may indicate camera damage. In this case, write down the error number (Exx) and contact a Canon Customer Support Help Desk.

File Error

- Correct printing (📖84) may not be possible for photos from other cameras or images that have been altered using computer software, even if the camera is connected to the printer.

Print error

- Check the paper size setting (📖86). If this error message is displayed when the setting is correct, restart the printer and complete the setting on the camera again.

Ink absorber full

- Contact a Canon Customer Support Help Desk to request assistance with ink absorber replacement.

Before Use

Basic Guide

Advanced Guide

Camera Basics

Auto Mode

Other Shooting Modes

P Mode

Playback Mode

Setting Menu

Accessories

Appendix

Index



On-Screen Information

Shooting (Information Display)

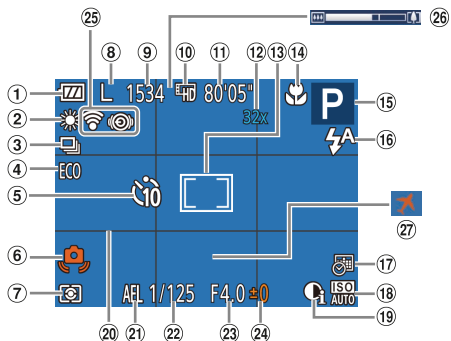

- | | | |
|--------------------------------|--|---|
| 1 Battery level (199) | 9 Recordable shots (108) | 15 Shooting mode (101), Scene icon (30) |
| 2 White balance (48) | 10 Movie quality (36) | 16 Flash mode (35, 53) |
| 3 Drive mode (35) | 11 Remaining time (108) | 17 Date stamp (32) |
| 4 Eco mode (71) | 12 Digital zoom magnification (31) | 18 ISO speed (47) |
| 5 Self-timer (33) | 13 AF frame (50), Spot AE point frame (47) | 19 i-Contrast (48) |
| 6 Camera shake warning (29) | 14 Focus range (49, 50) | 20 Grid lines (54) |
| 7 Metering method (47) | | 21 AE lock (46) |
| 8 Recording pixel setting (36) | | 22 Shutter speed |
| | | 23 Aperture value |

- | | | |
|-------------------------------------|---|-------------------|
| 24 Exposure compensation level (46) | 25 Eye-Fi/FlashAir connection status (92) | 26 Zoom bar (27) |
| | | 27 Time zone (71) |

Battery Level

An on-screen icon or message indicates the battery charge level.

Display	Details
	Sufficient charge
	Slightly depleted, but sufficient
 (Blinking red)	Nearly depleted—charge the battery pack soon
[Charge the battery]	Depleted—charge the battery pack immediately

Before Use

Basic Guide

Advanced Guide

Camera Basics

Auto Mode

Other Shooting Modes

P Mode

Playback Mode

Setting Menu

Accessories

Appendix

Index



Playback (Detailed Information Display)

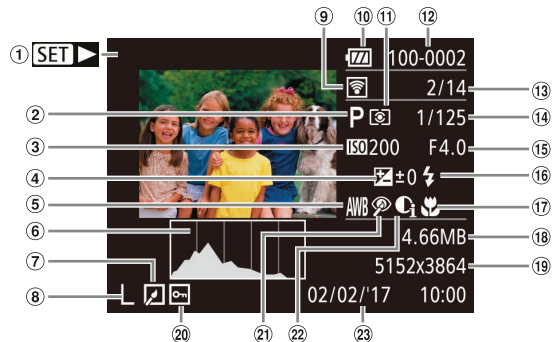

- | | | |
|---|---|---|
| <p>① Movies (pp27, 57)</p> <p>② Shooting mode (pp101)</p> <p>③ ISO speed (pp47), Playback speed (pp42)</p> <p>④ Exposure compensation level (pp46)</p> <p>⑤ White balance (pp48)</p> <p>⑥ Histogram (pp58)</p> <p>⑦ Image editing (pp67 – 68)</p> | <p>⑧ Recording pixel setting (pp36), MOV (movies)</p> <p>⑨ Transferred via Eye-Fi (pp92)</p> <p>⑩ Battery level (pp99)</p> <p>⑪ Metering method (pp47)</p> <p>⑫ Folder number – File number (pp74)</p> <p>⑬ Current image no. / Total no. of images</p> <p>⑭ Shutter speed (still images), Image quality / Frame rate (movies) (pp36)</p> | <p>⑮ Aperture value</p> <p>⑯ Flash (pp53)</p> <p>⑰ Focus range (pp49, 50)</p> <p>⑱ File size</p> <p>⑲ Still images: Recording pixel setting (pp108) Movies: Playback time (pp108)</p> <p>⑳ Protection (pp61)</p> <p>㉑ Red-eye correction (pp68)</p> |
|---|---|---|

㉒ i-Contrast (pp48, 67)

㉓ Shooting date/time (pp13)



- Some information may not be available when using a TV as the display (pp80).

Summary of Movie Control Panel in “Viewing” (pp57)

	Exit
	Play
	Slow Motion (Press the [◀][▶] buttons to adjust the playback speed. No sound is played.)
	Skip Backward* (To continue skipping backward, keep holding down the [⏮] button.)
	Previous Frame (For fast-rewind, keep holding down the [⏪] button.)
	Next Frame (For fast-forward, keep holding down the [⏩] button.)
	Skip Forward* (To continue skipping forward, keep holding down the [⏭] button.)
	Shown when the camera is connected to a PictBridge-compatible printer (pp84).

* Displays the frame approx. 4 sec. before or after the current frame.



- To skip forward or back during movie playback, press the [◀][▶] buttons.

Before Use

Basic Guide

Advanced Guide

Camera Basics

Auto Mode

Other Shooting Modes

P Mode

Playback Mode

Setting Menu

Accessories

















Appendix

Index



Functions and Menu Tables

Functions Available in Each Shooting Mode

Function	Shooting Mode														
	AUTO	P													
Flash (35 , 53)	 ^A	○	○	○	○	○	○	○	○	○	○	○	○	○	○
		–	○	–	○	○	–	○	○	○	○	○	○	○	○
	 *	*1	○	–	–	–	–	–	–	–	–	–	–	–	–
	 *	○	○	○	○	○	○	○	○	○	○	○	○	○	○
Date Stamp  (32)	Off	○	○	○	○	○	○	○	○	○	○	○	○	○	○
	Date / Date & Time	○	○	–	○	○	–	–	–	–	–	–	–	○	○
Screen Display (22)	No Information Display	○	○	○	○	–	○	–	–	–	–	○	○	○	○
	Information Display	○	○	○	○	○	○	○	○	○	○	○	○	○	○

*1 Not available, but switches to  in some cases.

○ Available or set automatically. – Not available.

Before Use

Basic Guide

Advanced Guide

Camera Basics

Auto Mode

Other Shooting Modes

P Mode

Playback Mode

Setting Menu

Accessories

Appendix

Index



FUNC. Menu

Function	Shooting Mode														
	AUTO	P	(P)	(A)	(S)	(M)	(L)	(B)	(C)	(V)	(A)	(S)	(M)	(L)	(B)
Light Metering (p47)		O	O	O	O	O	O	O	O	O	O	O	O	O	O
		-	O	-	-	-	-	-	-	-	-	-	-	-	-
White Balance (p48)	AWB	O	O	O	O	O	O	O	O	O	O	O	O	O	O
		-	O	O	-	O	O	-	-	-	-	-	-	-	O
ISO Speed (p47)	AUTO	O	O	O	O	O	O	O	O	O	O	O	O	O	-
	100, 200, 400, 800, 1600	-	O	-	-	-	-	-	-	-	-	-	-	-	O
Exposure Compensation (p46)		-	O	O	O	O	O	O	O	O	O	O	O	-	O
Self-Timer (p33)	Off	O	O	O	O	O	O	O	O	O	O	O	O	O	O
		O	O	O	O	-	O	O	O	O	O	O	O	O	O
Self-Timer Settings (p34)	Delay*1	O	O	O	O	-	O	O	O	O	O	O	O	O	O
	Shots*2	O	O	O	O	-	O	O	O	O	O	O	O	O	O
Focus Range (p49, 50)		O	O	O	O	O	O	O	O	O	O	O	O	O	O
		-	O	O	O	-	O	O	O	O	O	O	O	-	O
Drive Mode (p35)		O	O	*3	O	O	O	O	O	O	O	O	O	O	O
		O	O	*3	O	-	O	O	O	O	O	O	O	O	-

*1 Cannot be set to 0 seconds in modes without selection of the number of shots.

*2 One shot (cannot be modified) in modes without selection of the number of shots.

*3 Depending on the scene, consecutive shots may be combined (p40).

O Available or set automatically. - Not available.

Before Use

Basic Guide

Advanced Guide

Camera Basics

Auto Mode

Other Shooting Modes

P Mode

Playback Mode

Setting Menu

Accessories

Appendix

Index



Function	Shooting Mode															
	AUTO	P														
Recording Pixels (36)	L	<input type="radio"/>	<input type="radio"/>	–	<input type="radio"/>	<input type="radio"/>	–	<input type="radio"/>	<input type="radio"/>	<input type="radio"/>	<input type="radio"/>	<input type="radio"/>	<input type="radio"/>	<input type="radio"/>	<input type="radio"/>	<input type="radio"/>
	M1M2S	<input type="radio"/>	<input type="radio"/>	–	<input type="radio"/>	<input type="radio"/>	–	–	–	–	–	–	–	–	<input type="radio"/>	<input type="radio"/>
	M	–	–	<input type="radio"/>	–	–	<input type="radio"/>	–	–	–	–	–	–	–	–	–
	W	<input type="radio"/>	<input type="radio"/>	–	<input type="radio"/>	<input type="radio"/>	–	–	<input type="radio"/>	–	–	–	–	–	<input type="radio"/>	<input type="radio"/>
Movie Quality (36)		<input type="radio"/>	<input type="radio"/>	<input type="radio"/>	<input type="radio"/>	<input type="radio"/>	<input type="radio"/>	<input type="radio"/>	<input type="radio"/>	*1	<input type="radio"/>	<input type="radio"/>	<input type="radio"/>	<input type="radio"/>	<input type="radio"/>	<input type="radio"/>

*1 Synchronizes with the recording pixel setting and is automatically set [\(42\)](#).

Available or set automatically. – Not available.

Before Use

Basic Guide

Advanced Guide

Camera Basics

Auto Mode

Other Shooting Modes

P Mode

Playback Mode

Setting Menu

Accessories

Appendix

Index



Shooting Tab

		Shooting Mode													
		AUTO	P												
Function															
Easy Auto start (p37)															
Enable		O	O	O	O	O	O	O	O	O	O	O	O	O	O
Disable		O	O	O	O	O	O	O	O	O	O	O	O	O	O
AF Frame (p50)															
Face AiAF		O	O	O	O	O	O	-	-	O	O	O	O	-	O
Tracking AF		-	O	O	O	-	O	-	-	-	O	O	O	-	O
Center		-	O	O	O	-	O	O	-	O	O	O	O	O	O
Digital Zoom (p31, 54)															
On		O	O	-	O	O	-	-	-	-	-	-	-	O	O
Off		-	O	O	O	O	O	O	O	O	O	O	O	O	O
Servo AF (p51)															
Enable		-	O	O	O	-	O	-	-	-	O	O	O	-	-
Disable		*1	O	O	O	O	O	O	O	O	O	O	O	O	O
Continuous AF (p52)															
Enable		O	O	O	O	O	-	O	O	O	O	O	O	-	O
Disable		-	O	O	O	-	O	O	O	O	O	O	O	O	O
Lamp Setting (p37)															
On		O	O	O	O	O	O	O	O	O	O	O	O	-	O
Off		O	O	O	O	O	O	O	O	O	O	O	O	O	O
i-Contrast (p48)															
Auto		O	O	-	-	-	O	-	-	-	-	-	-	-	-
Off		-	O	O	O	O	-	O	O	O	O	O	O	O	O
Review image after shooting (p54)															
Display Time	Off/Quick/2 sec./4 sec./8 sec./Hold	O	O	O	O	O	O	O	O	O	O	O	O	O	O
Display Info	Off	O	O	O	O	O	O	O	O	O	O	O	O	O	O
	Detailed	-	O	O	O	O	O	O	O	O	O	O	O	O	O

*1 [Enable] when subject movement is detected.

O Available or set automatically. - Not available.

Before Use

Basic Guide

Advanced Guide

Camera Basics

Auto Mode

Other Shooting Modes

P Mode

Playback Mode

















Setting Menu

Accessories

Appendix

Index



Function	Shooting Mode														
	AUTO	P													
Grid Lines  54															
On	–	○	○	○	○	○	○	○	○	○	○	○	○	○	○
Off	○	○	○	○	○	○	○	○	○	○	○	○	○	○	○
Date Stamp  32	See "Functions Available in Each Shooting Mode"  101.														

○ Available or set automatically. – Not available.

Before Use

Basic Guide

Advanced Guide

Camera Basics

Auto Mode

Other Shooting Modes

P Mode

Playback Mode

Setting Menu

Accessories

Appendix

Index



⏏ Set Up Tab

Item	Reference Page	Item	Reference Page
Mute	70	Format	73
Volume	70	File Numbering	74
Hints & Tips	70	Create Folder	75
Date/Time	70	Video System	81
Time Zone	71	FlashAir	92
Lens Retraction	71	Eye-Fi Settings	92
Eco Mode	71	Certification Logo Display	75
Power Saving	21, 72	Language	15
Disp. Brightness	73	Reset All	76
Start-up Image	73		

▶ Playback Tab

Item	Reference Page	Item	Reference Page
Slideshow	60	Red-Eye Correction	68
Erase	64	Resize	67
Protect	61	Transition	57
Rotate	66	Auto Rotate	66
Photobook Set-up	90	Resume	57
i-Contrast	67		

🖨 Print Tab

Item	Reference Page	Item	Reference Page
Print	–	Select All Images	90
Select Images & Qty.	89	Clear All Selections	90
Select Range	90	Print Settings	88

▶ Playback Mode FUNC. Menu

Item	Reference Page	Item	Reference Page
Rotate	66	Play Movie	57
Protect	61	Image Search	59
Print	84	Slideshow	60

Before Use

Basic Guide

Advanced Guide

Camera Basics

Auto Mode

Other Shooting Modes

P Mode

Playback Mode

Setting Menu

Accessories

Appendix

Index



Handling Precautions

- The camera is a high-precision electronic device. Avoid dropping it or subjecting it to strong impact.
- Never bring the camera near magnets, motors, or other devices that generate strong electromagnetic fields, which may cause malfunction or erase image data.
- If water droplets or dirt adheres to the camera or screen, wipe with a dry soft cloth, such as an eyeglass cloth. Do not rub hard or apply force.
- Never use cleaners containing organic solvents to clean the camera or screen.
- Use a blower brush to remove dust from the lens. If cleaning is difficult, contact a Canon Customer Support Help Desk.
- To prevent condensation from forming on the camera after sudden temperature changes (when the camera is transferred from cold to warm environments), put the camera in an airtight, resealable plastic bag and let it gradually adjust to the temperature before removing it from the bag.
- If condensation does form on the camera, stop using it immediately. Continuing to use the camera in this state may damage it. Remove the battery pack and memory card, and wait until the moisture has evaporated before resuming use.
- Store unused battery packs in a plastic bag or other container. To maintain battery performance if you will not use the battery pack for some time, about once a year charge it and then use the camera until it runs out of power before storing the battery pack.

Specifications





Image Sensor

Image size	1/2.3 type
Camera Effective Pixels (Pixels may decrease due to image processing.).....	Approx. 20.0 megapixels
Total Pixels	Approx. 20.5 megapixels

Lens

Focal Length (35mm film equivalent).....	5.0 – 40.0 mm (28 – 224 mm)
Zoom Magnification	8x

Shooting Range (measured from the tip of the lens)

Shooting Mode	Focus Range	Maximum Wide Angle 	Maximum Telephoto 
AUTO	–	1 cm (0.4 in.) – infinity	1.3 m (4.3 ft.) – infinity
Other than the above		5 cm (2.0 in.) – infinity	1.3 m (4.3 ft.) – infinity
		1 – 50 cm (0.4 in. – 1.6 ft.)	–
		3.0 m (9.8 ft.) – infinity	3.0 m (9.8 ft.) – infinity

Before Use

Basic Guide

Advanced Guide

Camera Basics

Auto Mode

Other Shooting Modes

P Mode

Playback Mode

Setting Menu

Accessories

Appendix

Index



Shutter

Shutter Speed

Auto Mode (automatic settings)

Max. Tv.....	1 sec.
Min. Tv.....	1/2000 sec.

Range in all shooting modes

Max. Tv.....	15 sec.
Min. Tv.....	1/2000 sec.

Available Tv values

Shooting mode	Long Shutter mode
	15, 13, 10, 8, 6, 5, 4, 3.2, 2.5, 2,
	1.6, 1.3, 1

Aperture

F number

Wide angle	3.2 / 9.0
Telephoto	6.9 / 20.0

Flash

Built-in Flash

Flash Range (Max. wide angle)

closest point	50.0 cm (1.6 ft.)
farthest point.....	3.0 m (9.8 ft.)

Flash Range (Telephoto end)

closest point	1.3 m (4.3 ft.)
farthest point.....	1.5 m (4.9 ft.)

Monitor

Type.....TFT color liquid crystal

Screen Size

6.8 cm (2.7 in.)

Effective Pixels

Approx. 230,000 dots

Shooting

Digital zoom

Magnification	Approx. 4x
Maximum with Optical Zoom	Approx. 32x
Focal Length (Telephoto end, 35mm film equivalent).....	Approx. 896 mm equivalent
ZoomPlus (Number of recording pixels L).....	Approx. 16x

Continuous Shooting

Shooting speed*

Auto/P Normal Continuous

Continuous shooting speed..... Max approx. 0.8 shots/sec.

Low light Mode

Continuous shooting speed..... Max approx. 2.2 shots/sec.

* Continuous shooting speed may become slower due to the following factors:

Tv value/Av value/Subject conditions/Lighting conditions/Use of flash/Zoom position

Recording

File Format

DCF-compliant DPOF compatible (Version 1.1)
--

Data Type

Still Images

Recording Format.....Exif 2.3 (DCF 2.0)

Image

JPEG only

Movies

Recording Format.....MOV

Video

MPEG-4 AVC/H.264

Audio

MPEG-4 AAC-LC (monaural)

Before Use

Basic Guide

Advanced Guide

Camera Basics

Auto Mode

Other Shooting
Modes

P Mode

Playback Mode

Setting Menu

Accessories

Appendix

Index



Recorded Pixels, Number of shots per a memory card

Still Image

Using a 16 GB memory card (approx. shots)

L	3017
M	10798
M1	5925
M2	16755
S	80988
W	4015

Movie

Using a 16 GB memory card

Pixels	Recording file size	Recordable Time per 16 GB Memory Card (Approx.)	Single Clip Recording Time (Approx.)
HD (1280 x 720)	1781 KB/sec.	2 hr. 21 min. 58 sec.	29 min. 59 sec.
VGA (640 x 480)	607 KB/sec.	6 hr. 44 min. 38 sec.	1 hr.

- Continuous shooting is possible until the memory card becomes full or the recording length for one movie reaches approx. 29 minutes 59 seconds.

Power

Battery PackNB-11L

Number of Still Image Shots (CIPA compliant)	Approx. 210 shots
Number of Still Image Shots (Eco Mode On)	Approx. 285 shots
Movie Recording Time (CIPA compliant)	Approx. 55 min.
Playback Time*	Approx. 4 hr.

* Time when playing back a slideshow of still images.

Interface

Wired

Digital terminal

(Hi-Speed USB compliant).....Mini-B

Analog Video Output (NTSC/PAL)

Analog Audio OutputMonaural

Operating Environment

TemperatureMin. 0 °C (32 °F),
Max. 40 °C (104 °F)

Dimensions (CIPA compliant)

W95.2 mm (3.75 in.)

H54.3 mm (2.14 in.)

D22.1 mm (0.87 in.)

Weight (CIPA compliant)

Camera Body OnlyApprox. 111 g (approx. 3.92 oz.)

Including Battery Pack, Memory CardApprox. 126 g (approx. 4.44 oz.)

Before Use

Basic Guide

Advanced Guide

Camera Basics

Auto Mode

Other Shooting Modes

P Mode

Playback Mode

Setting Menu

Accessories

Appendix

Index



Battery Pack NB-11L

Type:	Rechargeable lithium-ion battery
Nominal Voltage:	3.6 V DC
Nominal Capacity:	680 mAh
Charging Cycles:	Approx. 300 times
Operating Temperatures:	0 – 40 °C (32 – 104 °F)

Battery Charger CB-2LF/CB-2LFE

Rated Input:	100 – 240 V AC (50/60 Hz)
Rated Output:	4.2 V DC, 0.41 A
Charging Time:	Approx. 2 hours
Operating Temperatures:	5 – 40 °C (41 – 104 °F)

- Size, weight, and number of shots available are based on measurement guidelines of the Camera & Imaging Products Association (CIPA).
- Under some shooting conditions, the number of shots and recording time may be less than mentioned above.
- Number of shots/time with a fully charged battery pack.

Before Use

Basic Guide

Advanced Guide

Camera Basics

Auto Mode

Other Shooting Modes

P Mode

Playback Mode

Setting Menu

Accessories

Appendix

Index



Index

A	
Accessories	79
AE lock	46
AF frames	50
Auto mode (shooting mode)	16, 27
AV cable	79, 80
B	
Batteries → Date/time (date/time battery)	
Battery charger	2, 79
Battery pack	
Charging	11
Eco mode	71
Level	99
Power saving	21
C	
Camera	
Reset all	76
Center (AF frame mode)	51
Color (white balance)	48
Continuous shooting	35
Cropping	86
Custom white balance	49
D	
Date/time	
Adding date stamps	32
Changing	14
Date/time battery	15
Settings	13
World clock	71
E	
Defaults → Reset all	
Digital IS (shooting mode)	40
Digital zoom	31, 54
Display language	15
DPOF	88
Drive mode	35
F	
Face AiAF (AF frame mode)	50
Face self-timer (shooting mode)	43
File numbering	74
Fireworks (shooting mode)	39
Fish-eye effect (shooting mode)	41
Flash	
Deactivating flash	35, 53
On	53
Slow synchro	53
FlashAir cards	2, 92

Focusing	
AF frames	50
Servo AF	51
Focus lock	51
Focus range	
Infinity	50
Macro	49
FUNC. menu	
Basic operations	23
Table	102, 106

G	
Grid lines	54

I	
i-Contrast	48, 67
Images	
Display period	54
Erasing	64
Playback → Viewing	
Protecting	61
Indicator	25, 37
Infinity (focus range)	50
ISO speed	47

L	
Long shutter (shooting mode)	44
Low light (shooting mode)	39

M	
Macro (focus range)	49
Magnified display	60
Memory cards	2
Recording time	108

Menu	
Basic operations	24
Table	101
Metering method	47
Miniature effect (shooting mode)	41
Monochrome (shooting mode)	43
Movies	
Recording time	108

P	
P (shooting mode)	46
Package contents	2
Photobook set-up	90
PictBridge	79, 84
Playback → Viewing	
Portrait (shooting mode)	39
Poster effect (shooting mode)	40
Power	79
→ Battery pack	
→ Battery charger	
Power saving	21
Printing	84
Program AE	46
Protecting	61

R	
Recording pixels (image size)	36
Red-eye correction	68
Reset all	76
Resizing images	67
Rotating	66

Before Use

Basic Guide

Advanced Guide

Camera Basics

Auto Mode

Other Shooting Modes

P Mode

Playback Mode

Setting Menu

Accessories

Appendix

Index



S	
Saving images to a computer	82
Screen	
Display language	15
Icons	99, 100
Menu → FUNC. menu, Menu	
SD/SDHC/SDXC memory cards	
→ Memory cards	
Searching	59
Self-timer	33
2-second self-timer	34
Servo AF	51
Shooting	
Shooting date/time → Date/time	
Shooting information	99
Slideshow	60
Software	
Installation	82
Saving images to a computer	82
Sounds	70
Strap	2, 11
Super vivid (shooting mode)	40

T

Terminal	80, 84
Toy camera effect (shooting mode)	42
Tracking AF	51
Traveling with the camera	71
Troubleshooting	95
TV display	80

V

Viewing	18, 57
Image search	59
Index display	58
Magnified display	60
Single-image display	18, 57
Slideshow	60
TV display	80

W

White balance (color)	48
Widescreen (recording pixel setting) ...	36
World clock	71
Wrist strap → Strap	

Z

Zoom	16, 27, 31
------------	------------

Before Use

Basic Guide

Advanced Guide

Camera Basics

Auto Mode

Other Shooting Modes

P Mode

Playback Mode

Setting Menu

Accessories

Appendix

Index



■ Trademarks and Licensing

- Microsoft and Windows are trademarks or registered trademarks of Microsoft Corporation in the United States and/or other countries.
- Macintosh and Mac OS are trademarks of Apple Inc., registered in the U.S. and other countries.
- The SDXC logo is a trademark of SD-3C, LLC.
- All other trademarks are the property of their respective owners.
- This device incorporates exFAT technology licensed from Microsoft.
- This product is licensed under AT&T patents for the MPEG-4 standard and may be used for encoding MPEG-4 compliant video and/or decoding MPEG-4 compliant video that was encoded only (1) for a personal and non-commercial purpose or (2) by a video provider licensed under the AT&T patents to provide MPEG-4 compliant video. No license is granted or implied for any other use for MPEG-4 standard.

■ Disclaimer

- Unauthorized reproduction of this guide is prohibited.
- All measurements based on Canon testing standards.
- Information subject to change without notice, as are product specifications and appearance.
- Illustrations and screenshots in this guide may differ slightly from the actual equipment.
- The above items notwithstanding, Canon cannot be held liable for any loss arising from the use of this product.

Before Use

Basic Guide

Advanced Guide

Camera Basics

Auto Mode

Other Shooting Modes

P Mode

Playback Mode

Setting Menu

Accessories

Appendix

Index

