

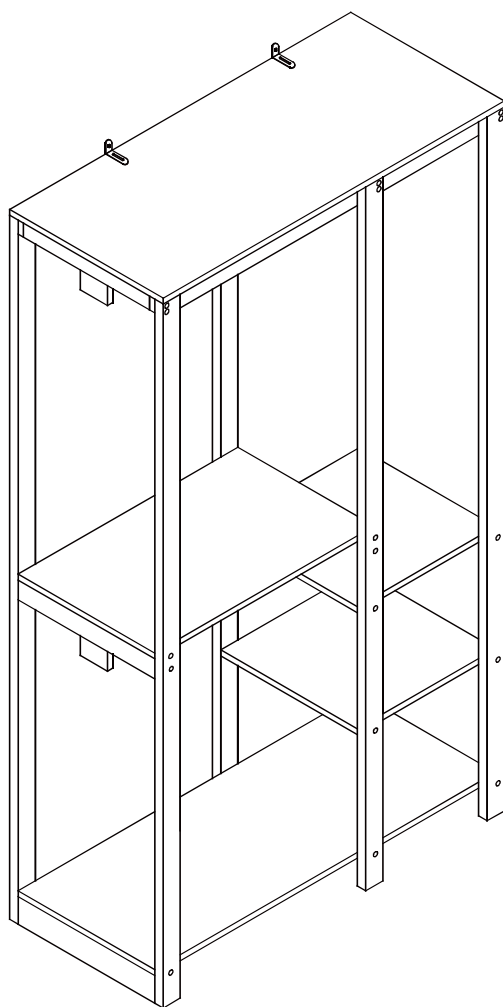

Open Decorative Wardrobe Unit White

HOME



Spare Parts

 www.argos-support.co.uk

 Help@ClickSpares.co.uk

 0370 112 1928

Customer Support

 0345 640 2020

Safety and Care Advice

Product Details

White 731/0913

IMPORTANT, RETAIN FOR FUTURE REFERENCE: READ CAREFULLY.

- Keep children and animals away from the work area, small parts could choke if swallowed.
- Make sure you have enough space to layout the parts before starting.
- This product has been constructed to be used in the domestic environment only and not for commercial purposes.

- Assemble the item as close to its final position (in the same room) as possible.
- Assemble on a soft level surface to avoid damaging the unit or your floor.



- We do not recommend the use of power drill/drivers for inserting screws as this could damage the unit.

Only use hand screwdrivers.

- Parts of the assembly will be easier with 2 people.
- Dispose of all packaging carefully and responsibly.

Care and maintenance

- Only clean using a damp cloth and mild detergent. Do not use abrasive cleaners.
- Use a dry cloth to clean the product, furniture polish is not recommended.

- From time to time check that there are no loose screws, nuts or bolts. If there are please re-tighten.

- This product should not be discarded with household waste. Take to your local authority waste disposal centre.

Additional Guidance

- Assemble all parts and bolts loosely during assembly, only once the product is complete should you fully tighten the bolts.
- Regularly check and ensure that all bolts and fittings are tightened properly.

Sainsbury's Argos is a trading name of both: Argos Limited, Registered office: 489-499 Avebury Boulevard, Milton Keynes, United Kingdom, MK9 2NW, registered number: 01081551 (England and Wales); and Sainsbury's Supermarkets Limited, Registered office: 33 Holborn, London, EC1N 2HT, registered number: 03261722 (England and Wales). Both companies are subsidiaries of J Sainsbury's plc.

Fittings

Bag 1

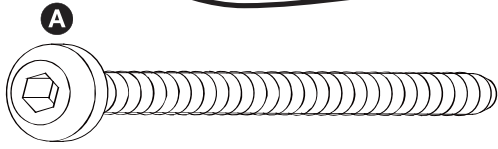

65mm Machine Screw x 12

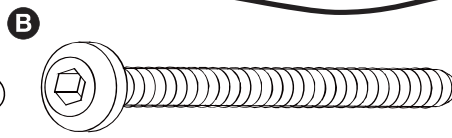

55mm Machine Screw x 22



10mm Barrel Nut x 34

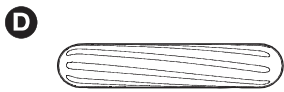

30mm Dowel x 16

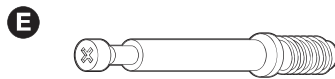

35mm Male Camlocks x 3

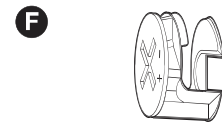

Female Camlocks x 3



40mm Screw x 12

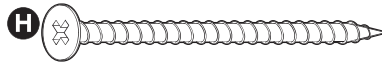

45mm Screw x 10



25mm Screw x 20



Rail Bracket x 4



12mm Screw x 8

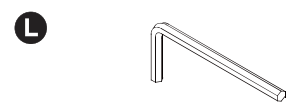

Hex Head Key x 1



Wall bracket x 2



12mm Screw x 2

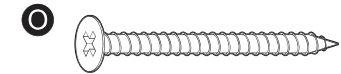

35mm Screw x 2

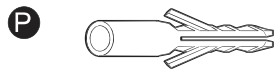

30mm Wall plug x 2



Screw Caps x 34

Tools required

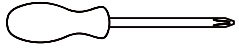

Phillips screwdriver
(small & medium)

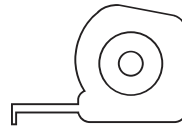

Ruler/tape
measure



Mallet

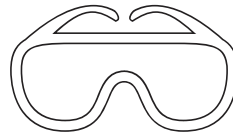

Eye protection
(when using a hammer
or glue)

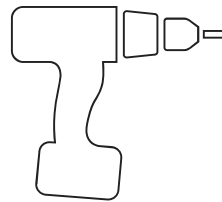

Power drill

Panels

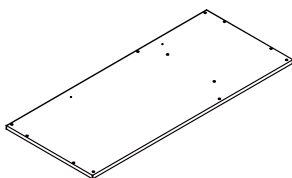

1 Top Panel x 1
(100(w)x45(d)cm)

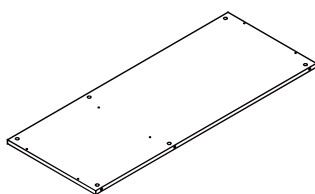

2 Base Panel x 1
(99.7(w)x39.9(d)cm)

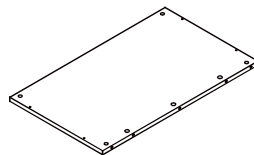

3 Middle Shelf Panel x 1
(66.7(w)x39.9(d)cm)

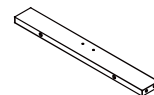

4 Middle Cross Bar x 2
(40(w)x4.9(d)cm)

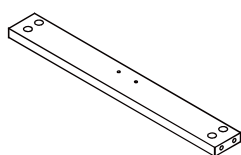

5 Upper Cross Bar x 2
(36.8(w)x4.9(d)cm)

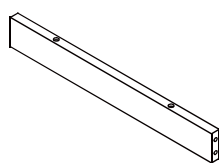

6 Base Cross Bars x 3
(39.9(w)x4.9(d)cm)

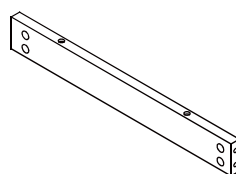

7 Central Cross Bar x 1
(36.8(w)x4.9(d)cm)

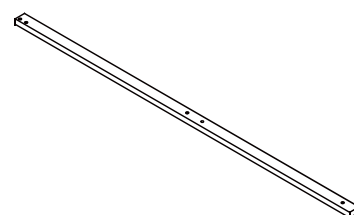

8 Front Left Upright x 1
(178.5(w)x4.9(d)cm)

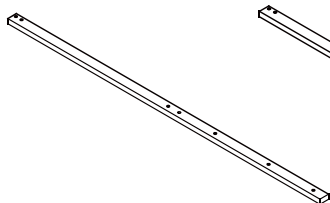

9 Front Middle Upright x 1
(178.5(w)x4.9(d)cm)

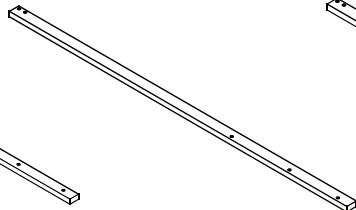

10 Front Right Upright x 1
(178.5(w)x4.9(d)cm)

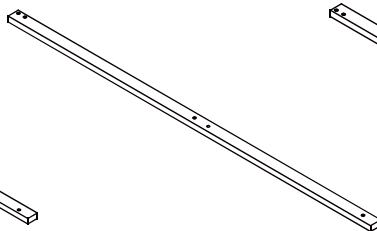

11 Back left Upright x 1
(178.5(w)x4.9(d)cm)

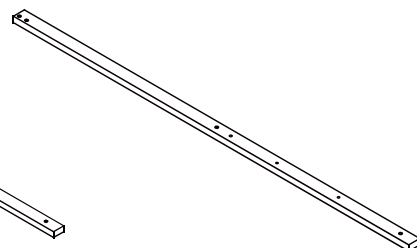

12 Back Middle Upright x 1
(178.5(w)x4.9(d)cm)

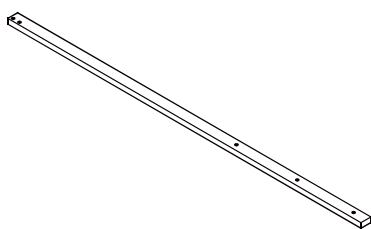

13 Back Right Upright x 1
(178.5(w)x4.9(d)cm)

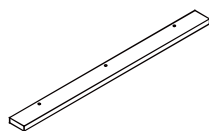

14 Back Cross Bar x 1
(57(w)x6.4(d)cm)

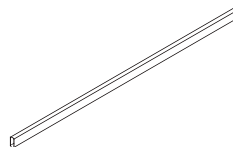

15 Long Rail x 1
(93(w)x3(d)cm)

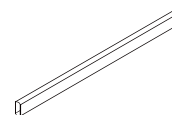

16 Short Rail x 1
(60.5(w)x3(d)cm)

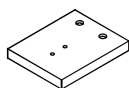

17 Rail Plinth x 1
(10(w)x8(d)cm)

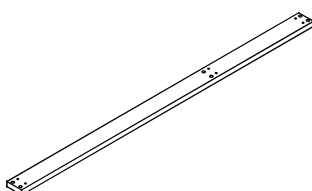

18 Front Top Bar x 1
(99.8(w)x4.9(d)cm)

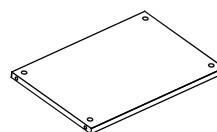

19 Lower Shelf Panels x 2
(39.9(w)x37.5(d)cm)

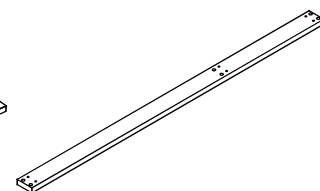

20 Back Top Bar x 1
(99.8(w)x4.9(d)cm)

1

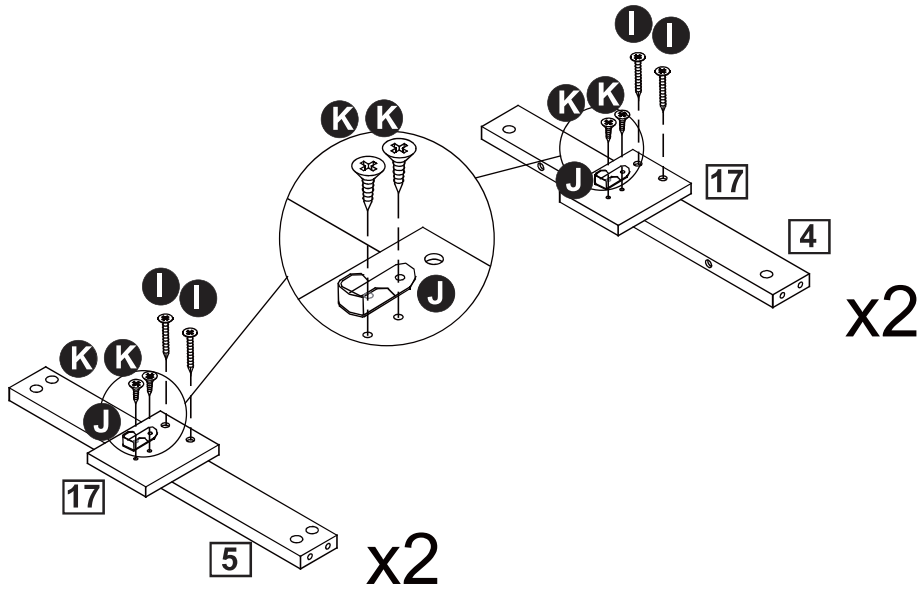
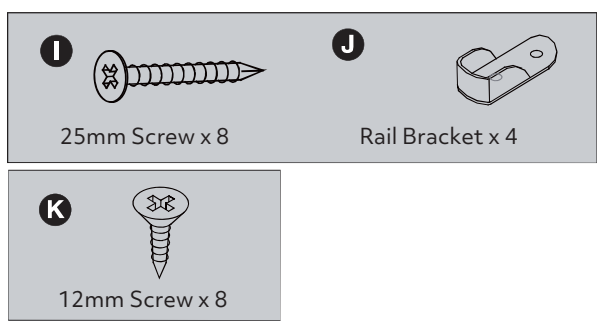
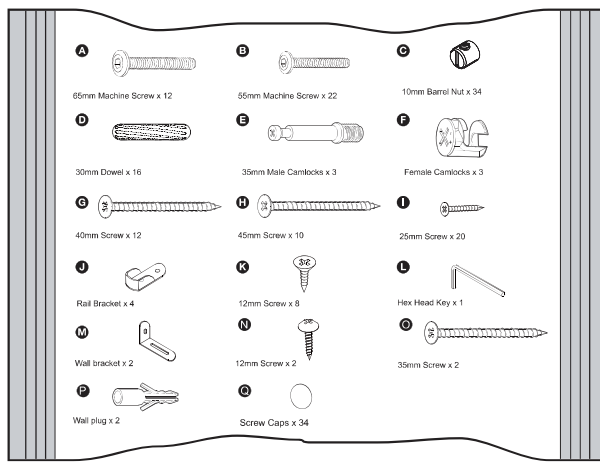

2

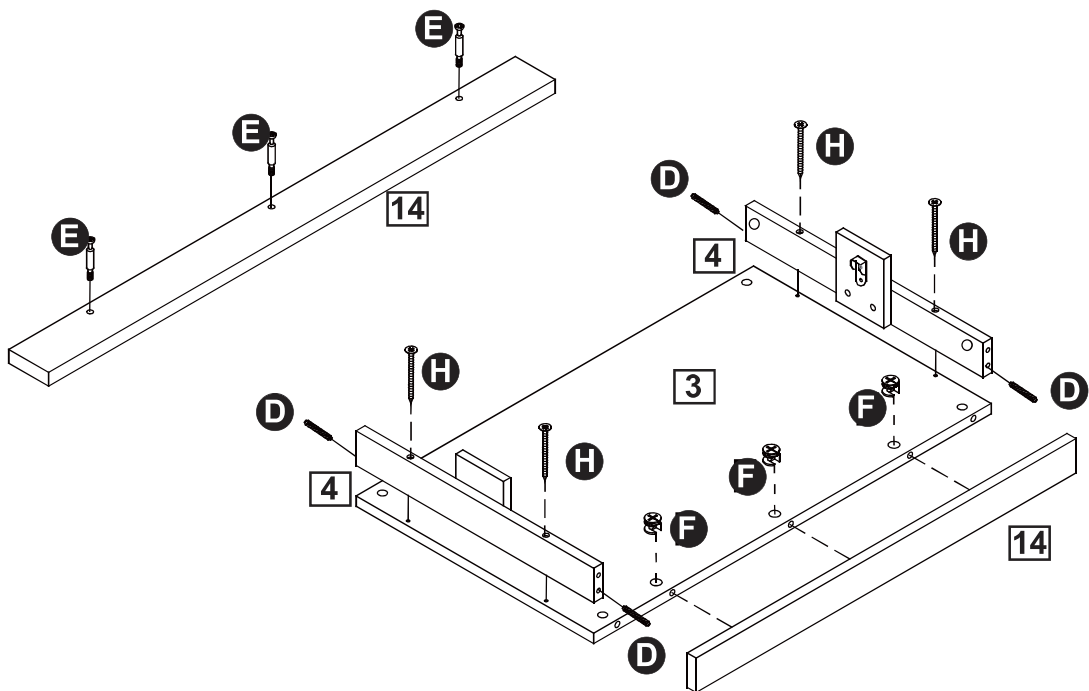
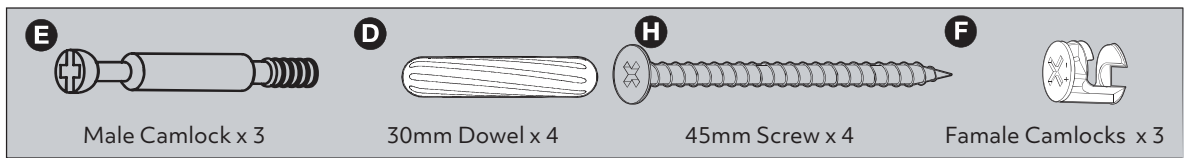

3

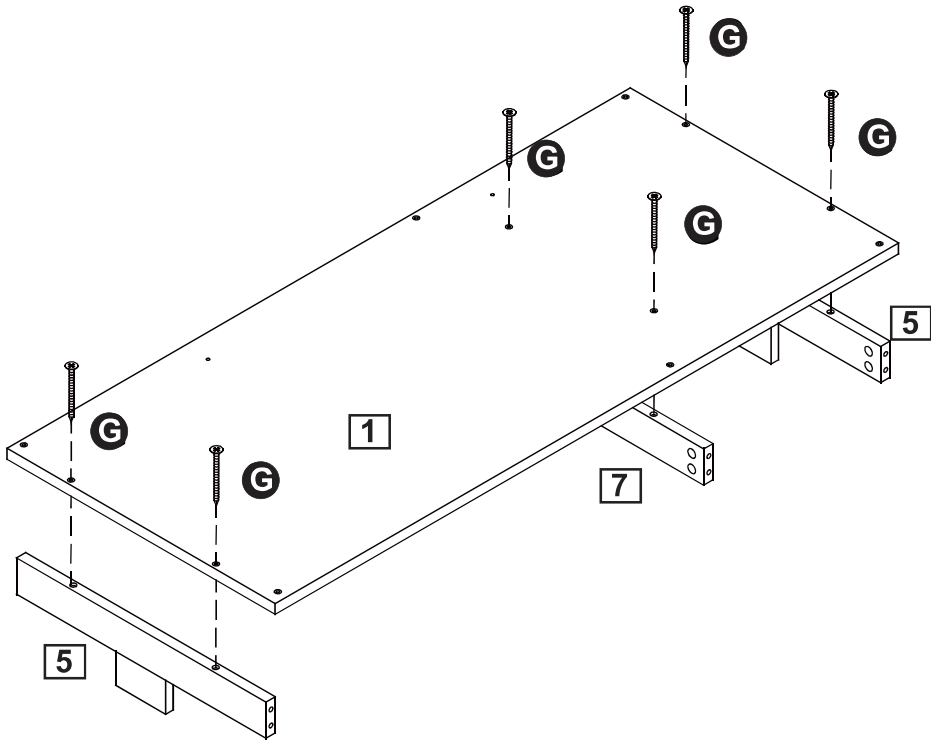
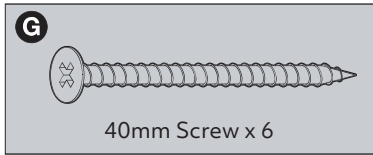

4

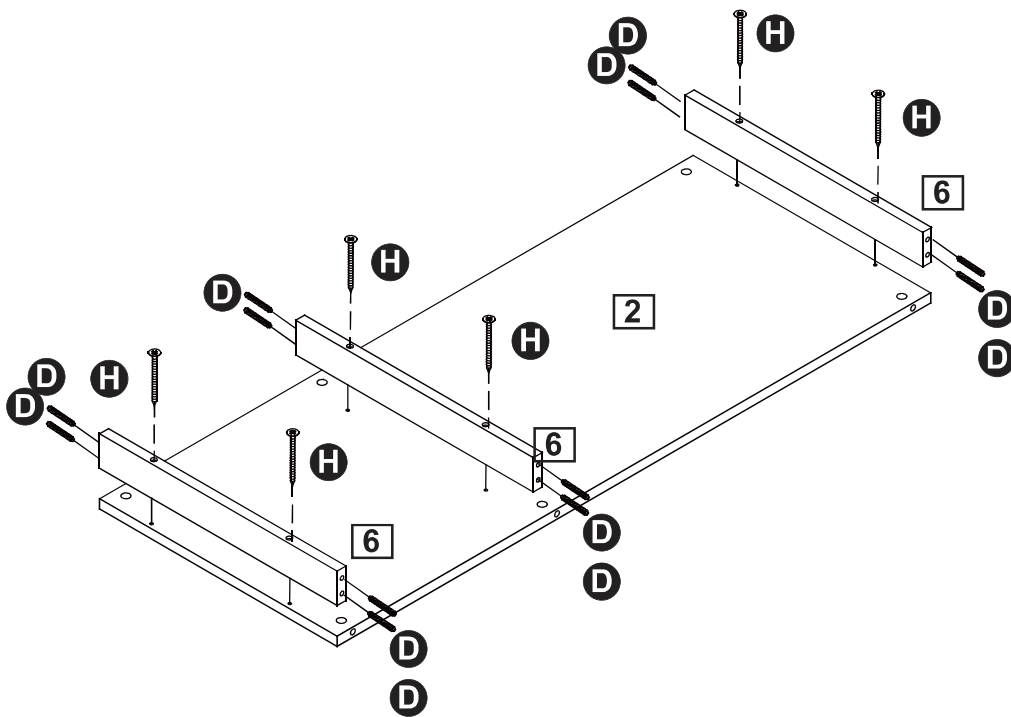
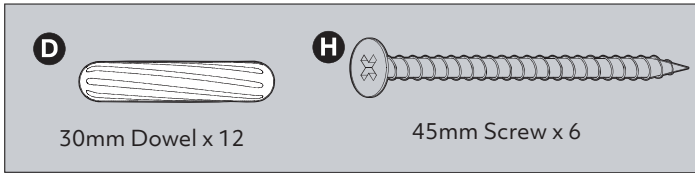

5

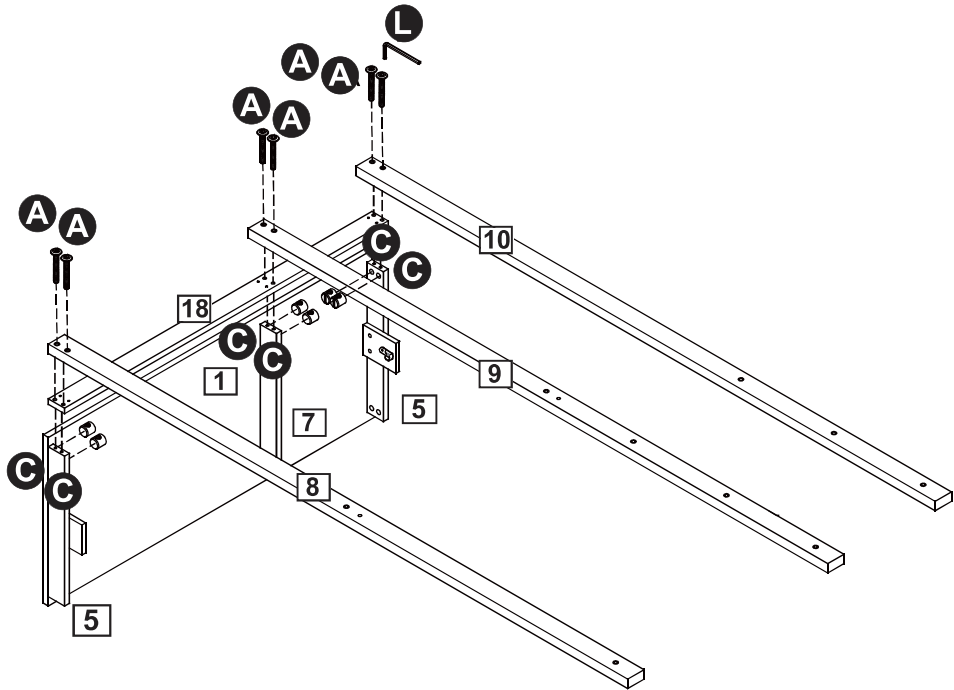
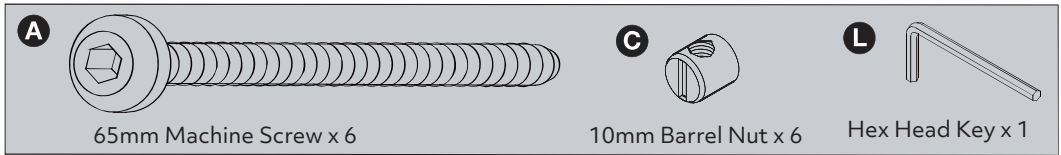

6

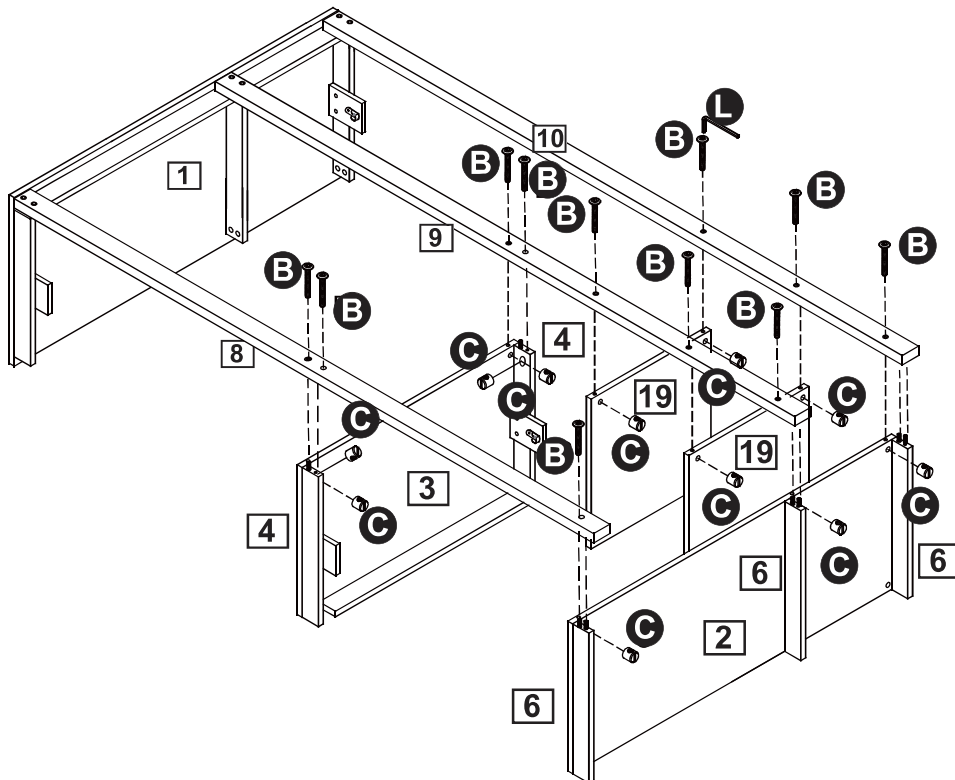
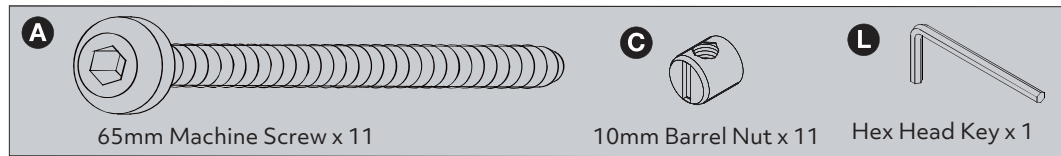

7

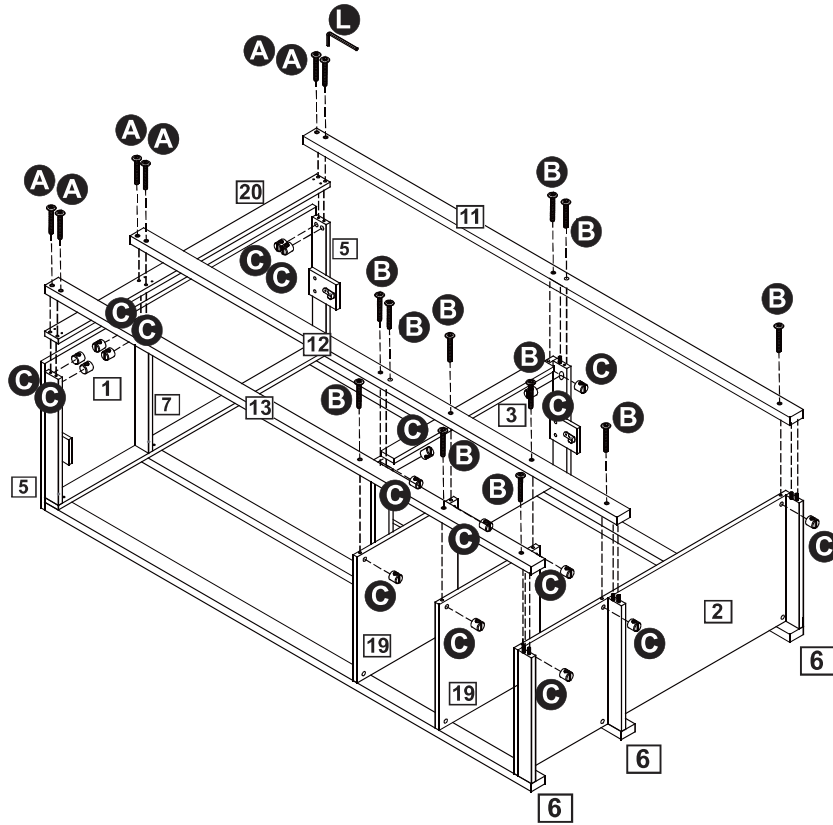
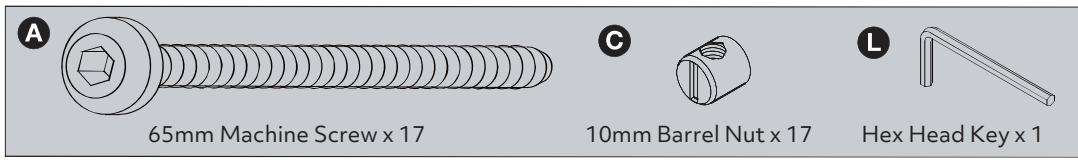

8

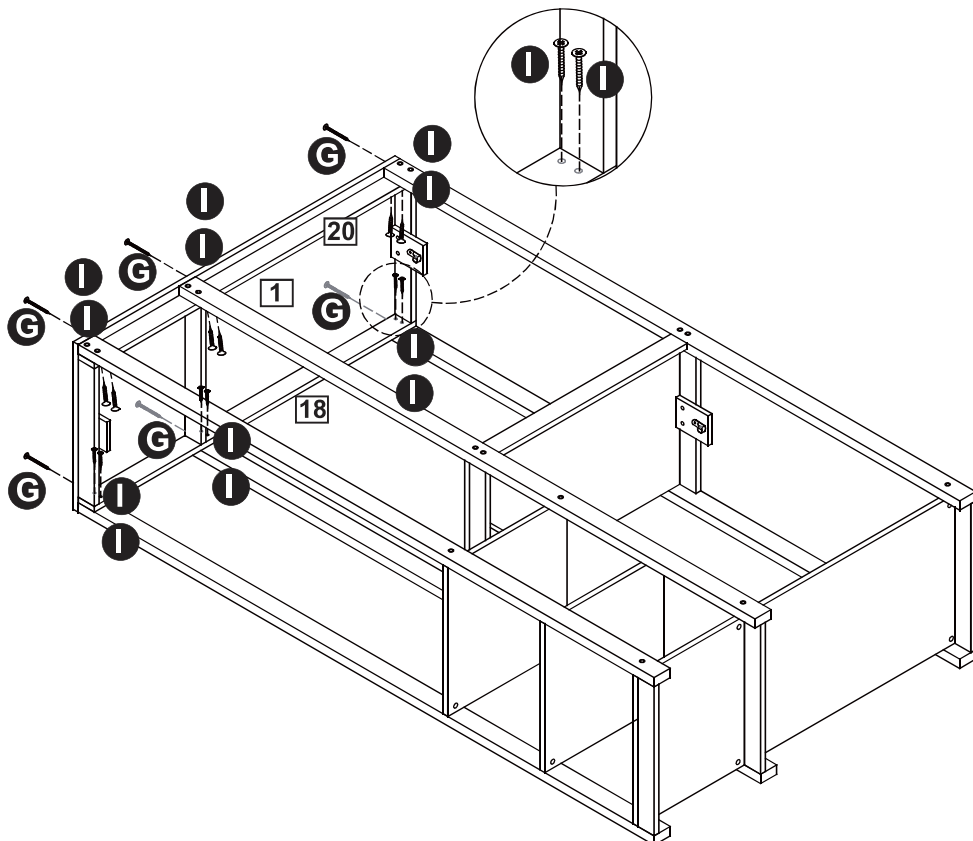
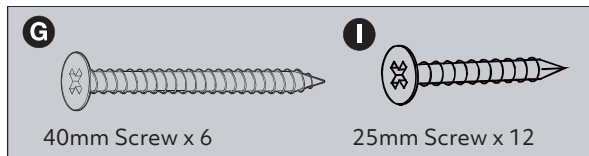

9

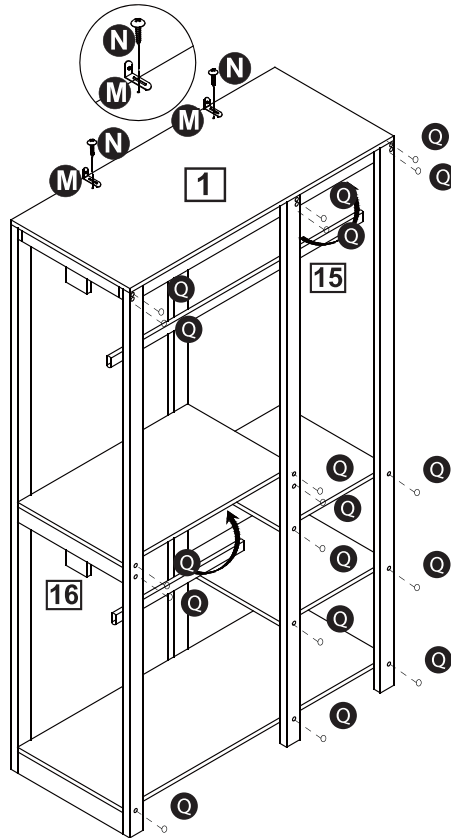
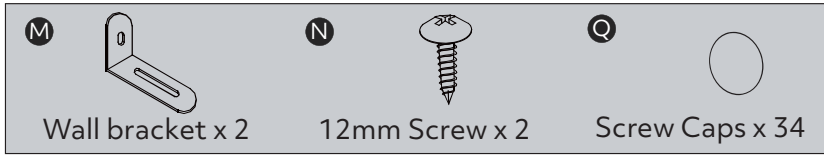

10

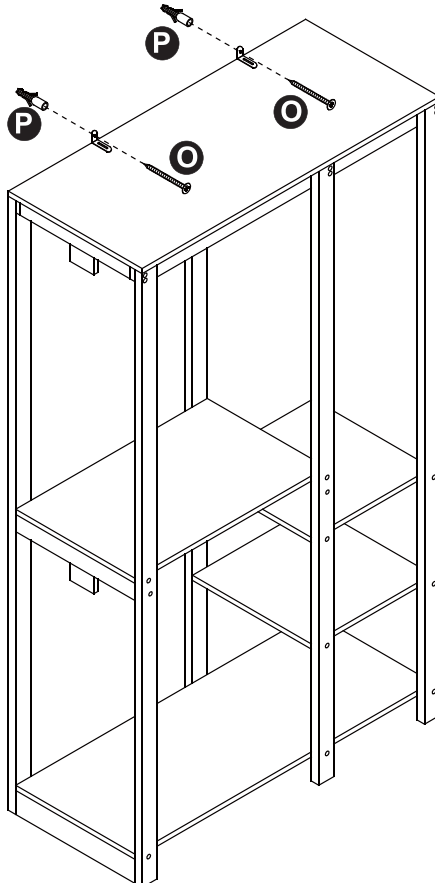
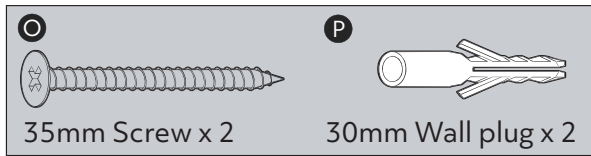

A Guide to Wall Mounting & Fixings

Important note:

If plastic wall plugs (rawl plugs) are supplied with your product, eg:



- these are suitable for use in masonry walls

If you are in any doubt about the correct wall plugs for your wall, seek professional advice.

Failure of the product due to using the incorrect fixings is the responsibility of the installer.



Important: when drilling into walls always check that there are no hidden wires or pipes etc.



Hints:

1. General rule: always use a larger screw and wall plug if you are not sure.
2. Ensure you use the recommended drill bit to match the wall plug and hole size.
3. Ensure you drill the hole horizontally; do not force the drill or enlarge the hole.
4. Take extra care when drilling high walls, ceilings and ceramic tiles. Ensure wall plugs are inserted beyond the thickness of the ceramic tiles to avoid the tiles splitting or cracking.
5. Ensure wall plugs are well fitted and are a tight fit in the drilled hole.

Types of walls

You can use one of the following types of wall plug if your walls are made of brick, breeze block, concrete, stone or wood.

No. 1 "General Purpose" wall plug

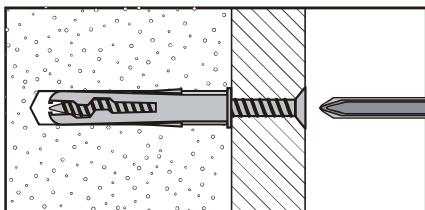

Generally aerated blocks should not be used to support heavy loads, use a specialist fitting in this case. For light loads, general purpose wall plugs can be used.

No. 3 "Cavity Fixing" wall plug

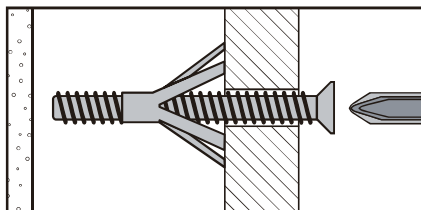

For use with plasterboard partitions or hollow wooden doors.

No. 5 "Hammer Fixing" wall plug

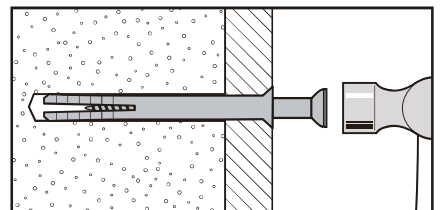

For use with walls stuck with plasterboard. The hammer fixing allows it to be fixed to the wall rather than the plasterboard. Always check the fixing is secure to the retaining wall.

No. 2 "Plasterboard" wall plug

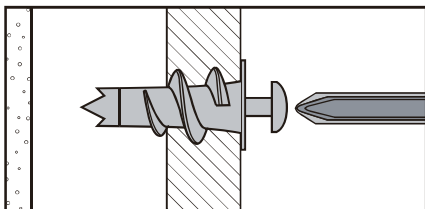

For use when attaching light loads onto plasterboard partitions.

No. 4 "Cavity Fixing - Heavy Duty" wall plug

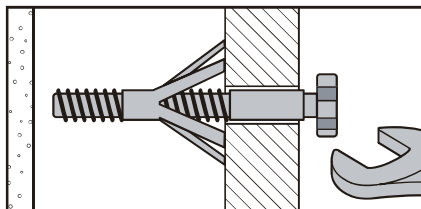

For use when fitting or supporting heavy loads such as shelving, wall cabinets and coat racks.

No. 6 "Shield Anchor" wall plug - heavy loads

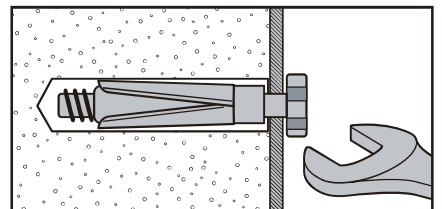

For use with heavier loads such as TV and HiFi speakers and satellite dishes etc.



Care & Maintenance

Safety: Always check the fitting and location to ensure your safety in and around the home.

Fitting: From time to time check the fitting to ensure the wall plugs or screws do not become loose.

Your 1 Year Guarantee

Peace Of Mind

Knowing Your Furniture Is Protected

Protection received within the Manufacturer's Guarantee	Optional Added Protection with Furniture Care
Covers you for manufacturing defects for 1 year.	Covers you for up to 2 years for specific structural defects following the expiry of the manufacturer's guarantee.
In the event of a problem within this time please call 0345 640 0800 , or visit an Argos store. Please retain your receipt and order number as proof of purchase.	Plus - covers you for accidental damage up to 3 years for incidents such as household spills, rips, tears and burns. Accidental damage cover begins from the moment your plan starts.
	If you want to purchase Furniture Care visit https://argos.productaftercare.co.uk or go into an Argos store.
Key exclusions applying to both the Manufacturer's Guarantee and Furniture Care include where the fault is due to misuse, abuse, deliberate damage, wear and tear, neglect, use in contravention with the instructions, or if the product has been the subject of unauthorised alterations or commercial use (for full list of exclusions please visit https://argos.productaftercare.co.uk or visit an Argos store for more information). You have up to 45 days post purchase to take out Furniture Care. Terms and conditions apply. Your statutory rights remain unaffected.	

Register

For Your Manufacturer's Guarantee

Thank you for choosing Argos Home.
We hope you love your shiny new things!

To provide you with the best possible after sales service, don't forget to visit **<https://argos.productaftercare.co.uk>** where you can **register** for your guarantee.

Once you've registered, you can upload your receipt to store safely online, alongside details of our after sales support service, ready at hand should you need it.

You can also take out Furniture Care which protects you against accidental damage, from the moment you take the plan out, to keep your new furniture looking newer for longer.

Register Today

<https://argos.productaftercare.co.uk>