

# Hisense

life reimagined

## **USER'S OPERATION MANUAL**

Before operating this unit, please read this manual thoroughly, and retain for future reference

**FT5K310GSFC**

**EN**

**English**

# Contents

**Thank you for choosing Hisense. We are sure you will find your new refrigerator a pleasure to use. However, before you use the appliance, we recommend that you carefully read the instructions, which provide details about installing and using the product. Please keep this manual for future reference.**

Safety and warning information .....	01
Installing your new appliance.....	13
Description of the appliance.....	16
Display controls.....	17
Using your appliance.....	22
Reverse the door .....	23
Cleaning and care.....	27
Helpful hints and tips.....	29
Troubleshooting.....	30
Disposal of the appliance.....	34

## Safety and warning information

For your safety and correct usage before installing and first using the appliance, read this user manual carefully, including its hints and warnings. To avoid unnecessary mistakes and accidents, it is important to make sure that all people using the appliance are thoroughly familiar with its operation and safety features. Save these instructions and be sure that they remain with the appliance if it is moved or sold, so that anyone using it throughout its life, will be properly informed on its usage and safety notices. For the safety of life and property, keep the precautions of these user's instructions as the manufacturer is not responsible for damages caused by omission.



### **Safety for children and others who are vulnerable people**

#### **According to EN standard**

This appliance can be used by children aged from 8 years and above and persons with reduced physical, sensory or mental capabilities or lack of experience and knowledge if they have been given supervision or instruction concerning use of the appliance in a safe way and understand the hazards involved. Children shall not play with the appliance. Cleaning and user maintenance shall not be made by children without supervision.

# Safety and warning information



## Safety for children and others who are vulnerable people

### According to IEC standard

This appliance is not intended for use by persons (including children) with reduced physical, sensory or mental capabilities, or lack of experience and knowledge, unless they have been given supervision or instruction concerning use of the appliance by a person responsible for their safety.

Keep all packaging away from children as there is risk of suffocation.

If you are discarding the appliance, pull the plug out of the socket, cut the connection cable (as close to the appliance as you can) and remove the door to prevent children playing from suffering an electric shock or from closing themselves inside it.

If this appliance, featuring a magnetic door seals, is to replace an older appliance having a spring lock (latch) on the door or lid, be sure to make the spring lock unusable before you discard the old appliance. This will prevent it from becoming a death trap for a child.

# Safety and warning information



## General safety

- **WARNING**

This appliance is intended to be used in residential household and similar applications such as 1.staff kitchen areas in shops, offices and other working environments; 2.farm houses and by clients in hotels, motels and other residential type environments;

1. bed and breakfast type environments;
2. catering and similar non-retail applications.

- **WARNING**

Fill with potable water only.

- **WARNING**

Do not store explosive substances such as aerosol cans with a flammable propellant in this appliance.

- **WARNING**

If the supply cord is damaged, it must be replaced by the manufacturer, its service agent or similarly qualified persons in order to avoid a hazard.

- **WARNING**

Keep ventilation openings, in the appliance enclosure or in the built-in structure, clear of obstruction.

# Safety and warning information



## General safety

- **WARNING**

Do not use mechanical devices or other means to accelerate the defrosting process, other than those recommended by the manufacturer.

- **WARNING**

Do not damage the refrigerant circuit.

- **WARNING**

Do not use electrical appliances inside the food storage compartments of the appliance, unless they are of the type recommended by the manufacturer.

- **WARNING**

The refrigerant and insulation blowing gas are flammable. When disposing of the appliance, do so only at an authorized waste disposal centre. Do not expose to flame.

- **WARNING**

When positioning the appliance, ensure the supply cord is not trapped or damaged.

# Safety and warning information

## General safety

- **WARNING**

Do not locate multiple portable socket-outlets or portable power supplies at the rear of the appliance.

## Replacing the illuminating lamps

- **WARNING**

The illuminating lamps must not be replaced by the user! If the illuminating lamps is damaged, contact the customer helpline for assistance. This warning is only for refrigerators that contain illuminating lamps.

## Refrigerant

The refrigerant isobutene (R600a) is contained within the refrigerant circuit of the appliance, a natural gas with a high level of environmental compatibility, which is nevertheless flammable. During transportation and installation of the appliance, ensure that none of the components of the refrigerant circuit becomes damaged. The refrigerant (R600a) is flammable.

# Safety and warning information

## Refrigerant

- **WARNING**

Refrigerators contain refrigerant and gases in the insulation. Refrigerant and gases must be disposed of professionally as they may cause eye injuries or ignition. Ensure that tubing of the refrigerant circuit is not damaged prior to proper disposal.



### **WARNING**

Risk of fire/flammable materials

If the refrigerant circuit should be damaged:

1. Avoid opening flames and sources of ignition.
2. Thoroughly ventilate the room in which the appliance is situated.

It is dangerous to alter the specifications or modify this product in any way.

Any damage to the cord may cause a short circuit, fire, and/or electric shock.



# Safety and warning information

## **Electrical safety**

1. The power cord must not be lengthened.
2. Make sure that the power plug is not crushed or damaged. A crushed or damaged power plug may overheat and cause a fire.
3. Make sure that you can access the main plug of the appliance.
4. Do not pull the main cable.
5. If the power plug socket is loose, do not insert the power plug. There is a risk of electric shock or fire.
6. You must not operate the appliance without the interior lighting lamp cover.
7. The fridge is only applied with power supply of single phase alternating current of 220~240V/50Hz. If fluctuation of voltage in the district of user is so large that the voltage exceeds the above scope, for safety sake, be sure to apply A. C. Automatic voltage regulator of more than 350W to the fridge. The fridge must employ a special power socket instead of common one with other electric appliances. Its plug must match the socket with ground wire.

# Safety and warning information

## Daily use

- Do not store flammable gas or liquids in the appliance, There is a risk of an explosion.
- Do not operate any electrical appliances in the appliance (e. g. electric ice cream makers, mixers etc.).
- When unplugging always pull the plug from the mains socket, do not pull on the cable.
- Do not place hot items near the plastic components of this appliance.
- This refrigerating appliance is not intended to be used as a built-in appliance.
- Do not place food products directly against the air outlet on the rear wall.
- Store pre-packed frozen food in accordance with the frozen food manufacture's instructions.
- The appliances manufactures storage recommendations should be strictly adhered to. Refer to relevant instructions for storage.
- Do not place carbonated or fizzy drinks in the freezer compartment as it creates pressure on the container, which may cause it to explode, resulting in damage to the appliance.

## Safety and warning information

- Do not place food products directly against the air outlet on the rear wall.
- Store pre-packed frozen food in accordance with the frozen food manufacture's instructions.
- The appliances manufactures storage recommendations should be strictly adhered to. Refer to relevant instructions for storage.
- Do not place carbonated or fizzy drinks in the freezer compartment as it creates pressure on the container, which may cause it to explode, resulting in damage to the appliance.
- Frozen food can cause frost burns if consumed straight from the freezer compartment.
- Do not place the appliance in direct sunlight.
- Keep burning candles, lamps and other items with naked flames away from the appliance so that do not set the appliance on fire.
- The appliance is intended for keeping food stuff and/or beverages in normal household as explained in this instruction booklet. The appliance is heavy. Care should be taken when moving it.
- Do not remove nor touch items from the freezer compartment if your hands are damp/wet, as this could cause skin abrasions or frost/freezer burns.
- Never use the base, drawers, doors etc. to stand on or as supports.

## Safety and warning information

- Frozen food must not be refrozen once it has been thawed out.
- Do not consume ice popsicles or ice cubes straight from the freezer as this can cause freezer burn to the mouth and lips. ,
- To avoid items falling and causing injury or damage to the appliance, do not overload the door racks or put too much food in the crisper drawers.
- In order to sense the temperature near the appliance and make the appliance run better, add temperature sensor outside the box of appliance.
- The WiFi module is installed in the control box at the top of appliance. In order to avoid interference and cause weak signal, it is recommended to cancel large-area metal products or water-containing drinks around the top of the box.

### **Caution! Care and cleaning**

- Before maintenance, switch off the appliance and disconnect the mains plug from the mains socket.
- Do not clean the appliance with metal objects, steam cleaner, ethereal oils, organic solvents or abrasive cleansers.
- Do not use sharp objects to remove frost from the appliance. Use a plastic scraper.

# Safety and warning information

## Installation Important

- For electrical connection carefully, follow the instructions given in this manual. Unpack the appliance and check if there are damages on it.
- Do not connect the appliance if it is damaged. Report possible damages immediately to the place you bought it. In this case retain packing.
- It is advisable to wait at least four hours before connecting the appliance to allow the oil to flow back in the compressor.
- Adequate air circulation should be around the appliance, lacking this leads to overheating. To achieve sufficient ventilation, follow the instructions relevant to installation.
- Wherever possible the back of the product should not be too close to a wall to avoid touching or catching warm parts (compressor, condenser) to prevent the risk of fire, follow the instructions relevant to installation.
- The appliance must not be locate close to radiators or cookers.
- Make sure that the mains plug is accessible after the installation of the appliance.

# Safety and warning information

- The appliance must not be located close to radiators or cookers.
- Make sure that the mains plug is accessible after the installation of the appliance.
- Transmitting frequency band(s) and max allowed transmitting power in the operating frequency band(s): 2400-2483.5MHz, less than or equal to 20dbm.
- This equipment should be installed and operated with minimum distance 20cm between the radiator & your body.

## Service

- Any electrical work required to do the servicing of the appliance should be carried out by qualified electrician or competent person.
- This product must be serviced by an authorized Service Center, and only genuine spare parts must be used.
  1. If the appliance is Frost Free.
  2. If the appliance contains freezer compartment.

### Note

Children aged from 3 to 8 years are allowed to load and unload refrigerating appliances. (This clause applies only to the EU region.)

# Installing your new appliance

Before using the appliance for the first time, you should be aware of the following tips.

## Ventilation of appliance

In order to improve efficiency of the cooling system and save energy, it is necessary to maintain good ventilation around the appliance for the dissipation of heat. For this reason, sufficient clear space should be available around the refrigerator.

### Suggest:

It is advisable for there to be 50-70mm of space from the back to the wall, at least 100mm from its top, at least 100mm from its side to the wall and a clear space upfront to allow the refrigerator door to open 105°. See in follow diagrams. Please refer to the diagrams below.

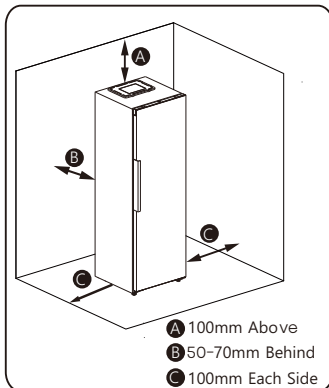

In the non-built-in status

Reserve a gap of more than 5mm on the top side

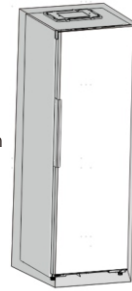

Reserve a gap of more than 2.5mm on the left side

Reserve a gap of more than 2.5mm on the right side

Product size(mm) : 595\*600\*1856

In the built-in status

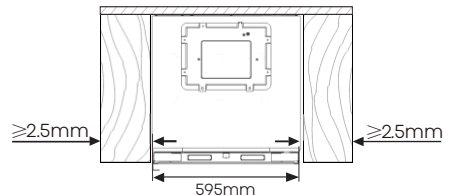

Door closing status for refrigerator in the built-in status

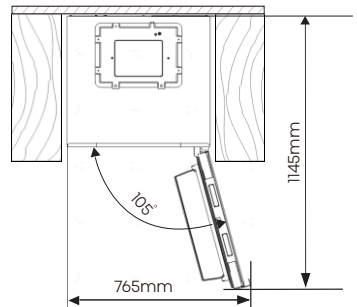

The total space required for the refrigerator to fully open the door in the built-in status

## Note

In the built-in status, energy consumption will increase significantly.

# Installing your new appliance

Relevant information (mm)

W	W1	D	D1	D2
595	170	600	627	1160

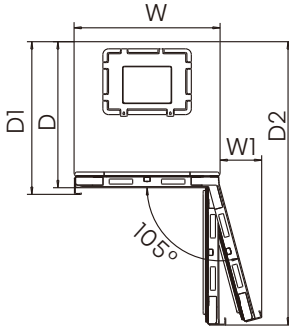

## Note

This appliance performs well in the climate class from SN to ST. It may not work properly if being left at a temperature above or below the indicated range for a long period.

Climate class	Ambient temperature
SN	+10°C to +32°C
N	+16°C to +32°C
ST	+16°C to +38°C
T	+16°C to +43°C

Stand your appliance in a dry place to avoid high moisture damage. Keep the appliance out of direct sunlight, rain or frost. Stand the appliance away from heat sources such as stoves, fires or heaters.

## Leveling of appliance

- For sufficient leveling and air circulating in the lower rear section of the appliance, the bottom feet may need to be adjusted. Please use a suitable spanner.
- To allow the doors to self-close, tilt back the top backwards at about 15mm or 0.5° by turning the adjustable feet.
- Whenever you want to move the appliance, remember to turn the feet back up, so that the appliance can roll freely. Reinstall the appliance when relocating.

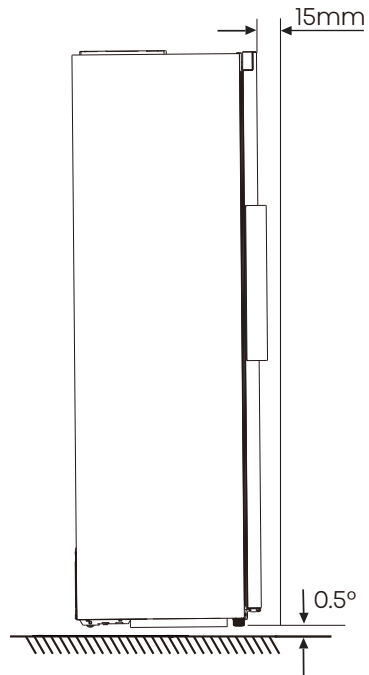



# Installing your new appliance



adjustable bottom feet

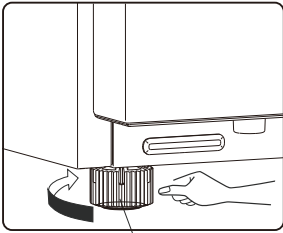

adjustable bottom feet

## Warning

- For proper installation, this refrigerator must be placed on a level surface of hard material that is the same height as the rest of the flooring. This surface should be strong enough to support a fully loaded refrigerator.
- The rollers, which are not castors, should be only used for forward or backward movement. Moving the refrigerator sideways may damage your floor and the rollers.

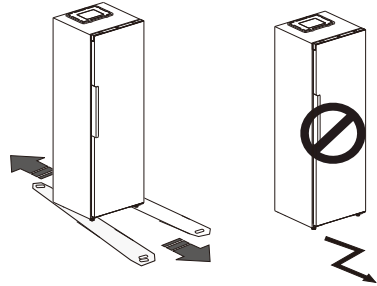

# Description of the appliance

## View of the appliance

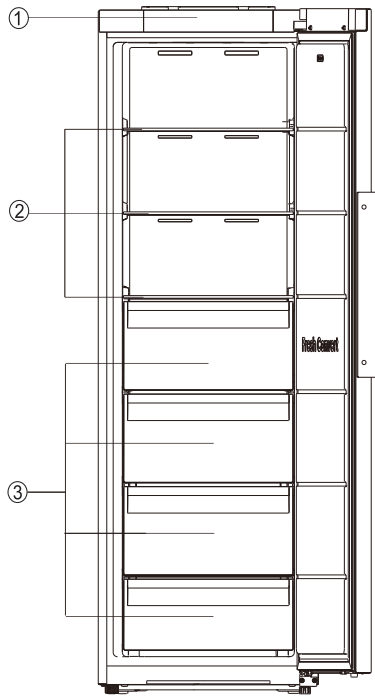

- ① Electronic control
- ② Storage shelves
- ③ drawer

### Note

Due to constant development of our products, your refrigerator may be slightly different from this instruction manual, but its functions and usage remain the same.

To get the best energy efficiency of this product, please place all shelves, drawers on their original position as the illustration above.

# Display controls

All functions and controls of the unit are accessible from a control panel conveniently located on the roof of the cabinet. A display circuit board allows easy configuration of features and settings in a simple and intuitive manner.

## Display Controls

Use your appliance according to the following control regulations, your appliance has the corresponding functions and models as the display panels showed in the pictures below. When the appliance is powered on for the first time, the backlighting of the icons on display panel starts working. If no button have been pressed and the doors are closed after one minute, the backlighting will turn off.



Electronic Control (located at the top of appliance)

### 1. Power



If you want to stop using it, you can turn the appliance off by pressing “Power” button for 3 seconds.

Press and hold “Power” button for 3 seconds to turn the standby function on or off.

When the standby function is on, the display panel will show “--”.

### Important!

Do not store any food in the refrigerator during this time. If you will not use the refrigerator for a long time, please pull the plug.





### Note

When the standby function is on, the refrigerator stops cooling and the light is off.

### 2. Eco



Press the “Eco”  button to turn on the energy saving function, the  icon will be illuminated.

When the Eco function is on, the temperature of the refrigerator is  $-17^{\circ}\text{C}$  when the refrigerator is in the freeze state, or the temperature of the refrigerator is  $6^{\circ}\text{C}$  when the refrigerator is in the fridge state. When Eco function is on, you can turn it off by pressing the “Temp” button or pressing the “Eco” button and the refrigerator temperature setting will revert back to the previous setting.

### 3. Super Cool/Freeze



Press the “Super Cool/ Freeze”  button to turn on Super Cool function or Super Freeze function.

# Display controls

► The Super Cool feature helps to keep food stored in the refrigerator at the setting temperature during periods of high usage, large grocery loads, or temporarily warm room temperatures. The Super Cool feature lowers the temperature in the fridge compartment.

1. When the refrigerator is in the fridge state, press the “Super Cool/Freeze” button to activate this function, then the temperature indicator will display 2°C. The “❄️” icon will be illuminated.

2. Super cool will automatically turn off after about 6 hours.

3. When super cool function is on, you can turn it off by pressing the “Super Cool/Freeze” button or pressing the “Temp” button. When the Super Cool function is manually turned off, the setting temperature will revert back to the previous setting.

► Super Freeze will quickly lower the temperature within the freezer so food will freeze faster than usual. This feature also helps to keep vitamins and nutrition of fresh food fresh for longer period.

1. When the refrigerator is in the freeze state, press the “Super Cool/Freeze” button to activate this function, then the temperature indicator will display -28°C. The “❄️” icon will be illuminated.

2. Super freezer will automatically turn off after about 52 hours.

3. When Super Freeze function is on, you can turn it off by pressing the “Super Cool/Freeze” button or pressing the “Temp” button. When the Super Freeze function is manually turn off, the setting temperature will revert back to the previous setting.



## Note

When you select the Super Freeze function, ensure there are no bottled or canned drinks (especially carbonated drinks) in the freezer compartment. Bottles and cans may explode.

## 4. Refrigerator Compartment Temperature

 Press the “Temp” button repeatedly to cycle from -14°C to -24°C when the refrigerator is in the freeze state.

If there is no operation, the setting temperature will take affect after 10 seconds.



## Note

Each press of the button decrease the setting temperature by one degree.

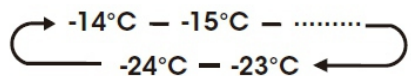

# Display controls

When the refrigerator is in the fridge state, the temperature will cycle from 8°C to 2°C .

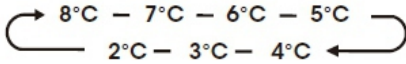



**NOTE:** Setting Compartment Temperatures: When you set a temperature, you are setting an average temperature for the entire compartment. The actual compartment temperatures may vary from the temperatures displayed depending on the amount and placement of stored food, and the surrounding room temperature. Recommended Temperature Settings When the refrigerator is in the freeze state, the recommended temperature is -18°C. When the refrigerator is in the fridge state, the recommended temperature is 4°C.

## 5. Alarm



**High temperature alarm:**  
Alarm If the temperature inside the appliance is too high, an alarm will sound to alert you and the “” icon will illuminated.

**Switching off the alarm:**  
If you want to switch off the acoustic alarm, briefly press the “Alarm” button. The “” icon will remain illuminated until the actual temperature in the appliance drops below the alarm level.

When the appliance reaches an adequate temperature, then the “” icon will extinguished, high temperature alarm cleared. If you have not cancelled the high temperature alarm, the “” icon will remain illuminated, and the buzzer will sound three times per minute. After more than 10 minutes, the alarm will stop.

## 6. Door Open Alarm

If a door is open for longer than 1 minutes, an alarm will sound to alert you. The alarm will sound 5 times every minute in the first and second minutes. Starting from the third minute, the alarm will sound once per second. If the alarm beeps for a long time, the buzzer will stop after 10 minutes of opening the door.

Press any button to cancel the door alarm, which makes the buzzer sound stop. Also the door alarm can be stopped by closing the door. When the door has been closed, open the door again will restart the timer of door open alarm.



## 7. Demo mode

Demo mode is for store display, and it prevents the refrigerator from generating cool air. In this of Cooling off Mode, the refrigerator may seem like it is working but it will not make cool air. If there is no button operation for 10

# Display controls

seconds, it will keep display "OF", otherwise it will display the set temperature. To switch off demo mode, press and hold "Power" And "Wi-Fi" buttons at same time for three seconds and the buzzer beeps 3 times.

## 8. Convert

 Press and hold "Convert"  button for 5 seconds to turn the Convert function on or off.

### Caution!

Before changing the compartment setting, make sure that the stored food is suitable for new setting mode. If not, please empty it first. When the freezer mode is changed to fridge mode, please open the door about 30 minutes before putting in the food that needs to be refrigerated.

When the fridge mode is changed to freezer mode, please close the door and run about 200 minutes before putting in the food that needs to be frozen.

Activating the Convert function: Press the "Convert" button for 5 seconds. A beep will be sounded, and the "  " indicator will light up.

- When this function is activated, the temperature in the compartment will be set to 4°C.
- Setting the temperature in the Fridge zone compartment: use the "Temp" button to set the temperature between +2°C and +8°C.

- Deactivating the Convert function press the "Convert" button for 5 seconds again. A beep will be sounded, and the Convert indicator will no longer be lit. When the Convert function is deactivated, the temperature in the freezer compartment will be set to -18°C.

## 9. Connecting your refrigerator to Wi-Fi

 ConnectLife app is a smart home app that allows you to communicate with your smart appliances using a smartphone or tablet.

Installation

1. Open the Apple App Store (iOS) or Google Play Store (Android) on your smartphone.
2. Search for the "ConnectLife" app. You will see an app with the following icon:



APP Version

Current Android&IOS Version: V2.2.0

The version of the App is constantly being changed and upgraded, please refer to the version that is actually downloaded from the App Store, AppGallery or Google Play store.

# Display controls

3. Download and install the ConnectLife app provided by Connect Life, LLC. Alternatively, you can scan the following QR code with your smart phone or tablet to find the ConnectLife app:



## Note

- The distance between your appliance and the Wi-Fi router can impact the performance. If they are too far apart pairing your appliance might fail or take longer.
- The appliance supports 2.4 GHz Wi-Fi networks only. The Wi-Fi network SSID must be visible.
- The surrounding wireless environment (other connected devices) can affect the performance of your network.
- Your appliance Wi-Fi connection may experience interruptions due to external factors such as your home network environment or Internet service provider.

## Connecting your refrigerator

After installing the Connectlife app, sign in or create an account and follow these steps:

1. Ensure the appliance is powered on and the display panel is active. You'll know it's ready when the panel lights up.



2. Press and hold the Wi-Fi button for 3 seconds until you hear a beep and see the "Wi-Fi" light flashing after it constantly on for a few seconds.

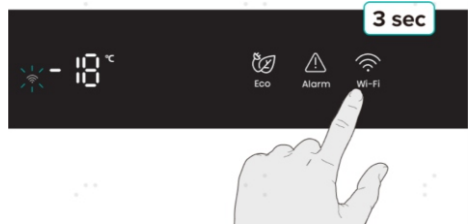

3. Ensure Bluetooth is enabled on your phone and open the ConnectLife app. Look for the pop-up indicating that a new appliance has been found. Tap the button on the pop-up and follow the instructions to proceed.

4. If a pop-up doesn't appear, tap the button called "Add appliance" or "+" in the app.

# Display controls

5. Locate "Refrigerator" in the device list and select it.

6. Follow the instructions in the app connect your refrigerator. Once the setup is complete, your refrigerator will appear on your home screen.



## Note

- The appliance will remain in pairing mode for a maximum of 5 minutes.
- The factory reset your network settings, press and hold the Wi-Fi button for 6 seconds. You will hear two beeps once the appliance is reset.
- After resetting, the appliance will automatically go into pairing mode.
- A solid Wi-Fi light indicates the appliance is successfully connected to the home network.

# Using your appliance

Your appliance has the accessories as the "Description of the appliance" showed in general, with this part instruction you can have the right way to use them. We recommend that you read them carefully before using the appliance.

## Storage shelves

- The storage shelves can be taken out to be cleaned.

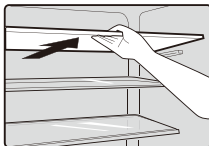

## drawer

- When the refrigerator is in the freeze

state, it is used to store food which need to be frozen, including meat, fish and ice cream, etc.

- When the refrigerator is in the fridge state, it is suitable for storage of vegetables and fruit, etc.

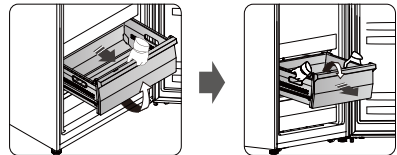

- To remove the drawer, tilt up the front of the drawer and pull forward, then tilt the drawer downwards, and remove it forward with both hands.



# Reverse the door

The side in which the door opens can be changed from the right side (as supplied) to the left side, if the installation site allows for it.

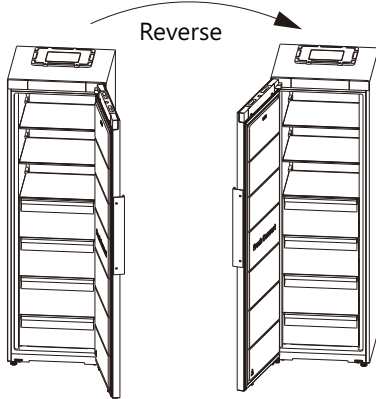

## WARNING

When reversing the door, the appliance must not be connected to the mains. Ensure that the plug is removed from the mains socket.

The parts you will need (provided):

Provided	
Case Corner Cover(left)	Case Corner Cover(right)
1	1
Door Corner Cover(left)	Door Corner Cover(right)
1	1
left upper hinge part	4mm Allen Wrench
1	1
hole cover	
1	



## Note

You should rest the appliance on soft foam packaging or similar material to avoid damage. If required you may lay the refrigerator on its back in order to gain access to the base.

The tools you will need (Not provided):

Not provided	
8mm socket driver	Thin-blade screwdriver
Cross-shaped screwdriver	Adjustable Wrench
Putty knife	

1. Stand the refrigerator upright, open the door, use a thin-blade screwdriver to pry off the Door Corner cover(right), the Door Corner cover(left), the Case cover(right) and the Case cover(left), and then put the corner covers in the accessory bag for backup.

**NOTE:** you should need to pad the pry area with cloth towel to avoid scratching the top of the refrigerator.

# Reverse the door

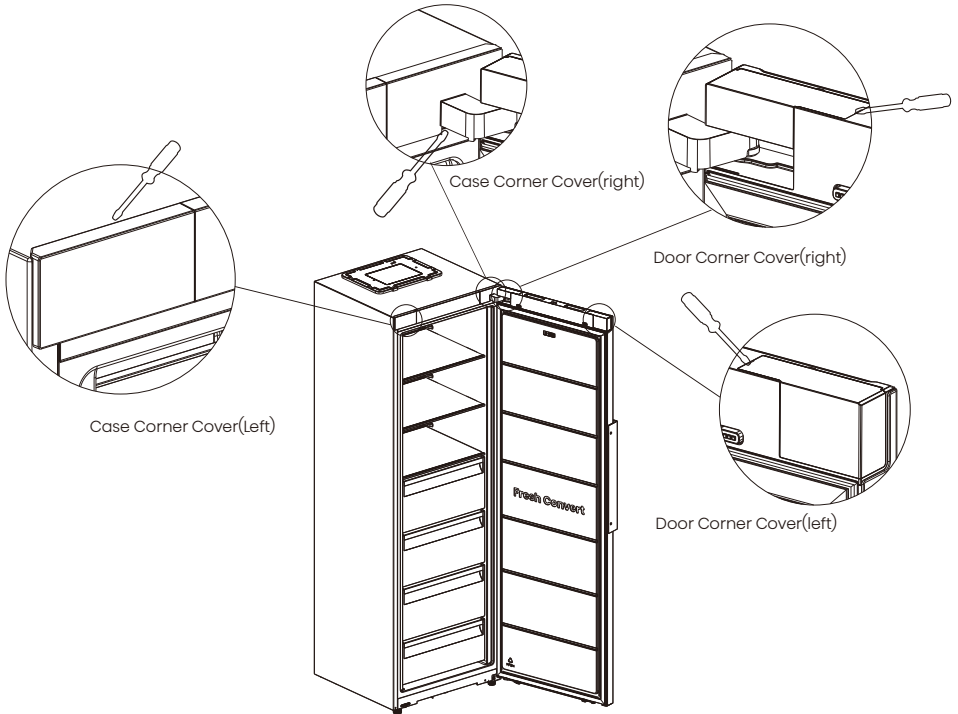

2.Using the 4mm Allen Wrench to remove the two screws on the right side that hold the right upper hinge part in place and the screw on the left side.(Please support the door when you doing it.)

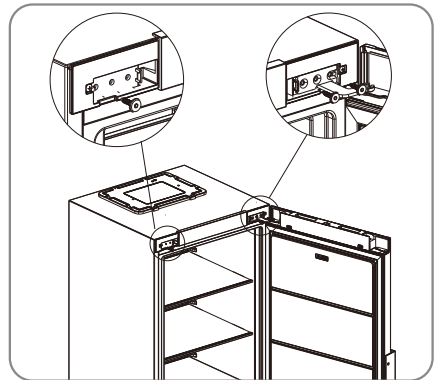

# Reverse the door

3.Remove the door and place it on a smooth surface with its panel upwards.Loose 2 self-tapping screws , detach the stopper,the door backstop and the shaft sleeve, then install the stopper , the door backstop and the shaft sleeve to the left side with 2 self-tapping screws .

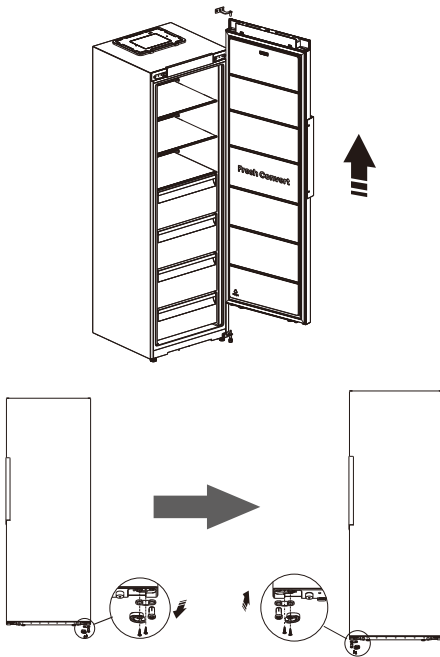

4.Using a cross-shaped screwdriver to unscrew the screws on the handle.And using a putty knife to remove the screw hole covers on the other side of the door .

Then install the screw hole covers to the left side of the door. Finally, using a cross-shaped screwdriver to install the screws on the handle.

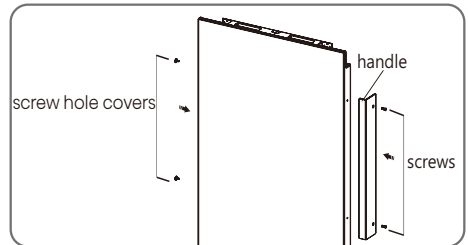
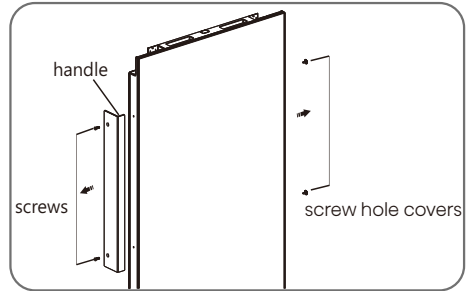

5.Lay the refrigerator on soft foam packaging or similar material. Remove the adjustable bottom feet parts, then remove the lower hinge part by unscrewing the screws .Finally unscrew the bottom hinge axis and remove it to the hole which is other side and screw it.

# Reverse the door

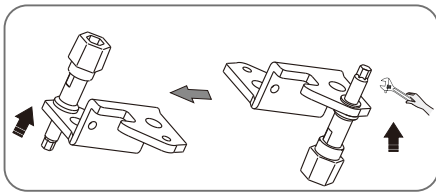
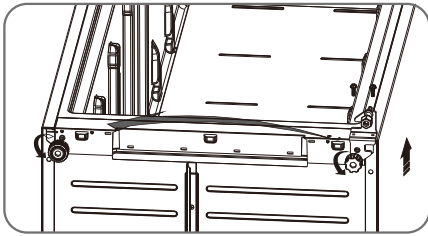

6. Replace the lower hinge part to the left side and fixing it with the special flange screws. Replace the adjustable bottom feet part to another side and fixing it. Install the hole cover (provided in the accessory bag) to hole of lower cover plate.

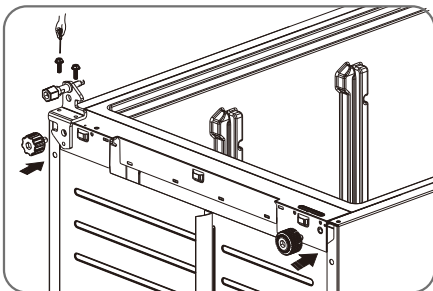

7. Transfer the door to appropriate position. Align the lower hole of the door with the upper hinge shaft of the lower hinge, then align the upper hole of the door with the hinge shaft of the left upper hinge. Finally adjust the left upper hinge to the appropriate position and then install it with 2 screws.

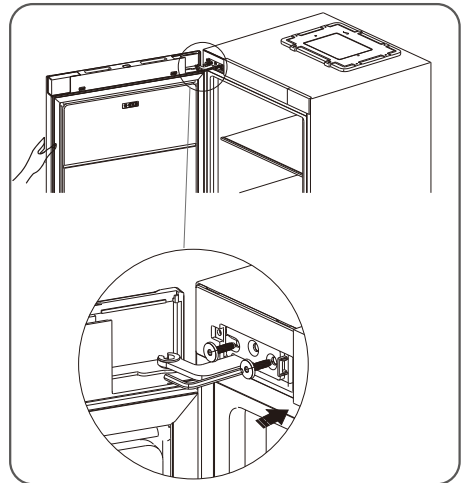

8. Reinstall the Door Corner cover (right), the Door Corner cover (left), the Case Corner cover (right) and the Case Corner cover (left) which are taken from the accessory bag.

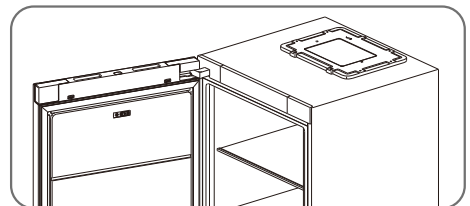

# Cleaning and care

- For hygienic reasons the appliance (including exterior and interior accessories) should be cleaned regularly (at least every two months).

## Warning

- The appliance must not be connected to the mains during cleaning. Danger of electrical shock! Before cleaning switch the appliance off and remove the plug from the mains socket.

## Exterior cleaning

To maintain good appearance of your appliance, you should clean it regularly.

- Wipe the digital panel and display panel with a clean, soft cloth.
- Spray water onto the cleaning cloth instead of spraying directly on the surface of the appliance. This helps ensure an even distribution of moisture to the surface.
- Clean the doors, handles and cabinet surfaces with a mild detergent and then wiped dry with a soft cloth.

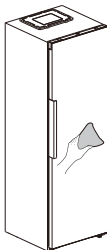

## Warning

- Do not use sharp objects as they are likely to scratch the surface.
- Do not use Thinner, Car detergent Clorox, ethereal oil, abrasive cleansers or organic solvent such as Benzene for cleaning. They may damage the surface of the appliance and may cause fire.

## Interior cleaning

- You should clean the appliance interior regularly. It will be easier to can remove the drawers and shelves for a more thorough clean.
- Wipe the inside of the freezer with a weak solution of bicarbonate of soda, and then rinse with warm cloth. Wipe completely dry before replacing the shelves and baskets.
- Thoroughly dry all surfaces and removable parts before putting them back into place.

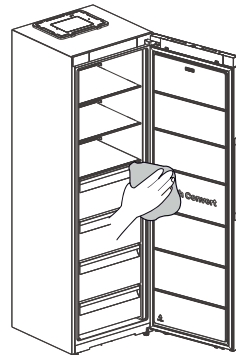

# Cleaning and care

- Although this appliance automatically defrosts, a layer of frost may occur on the freezer compartment's interior walls if the freezer door is opened frequently or kept open too long.
- If the frost is too thick, choose a time when the freezer is nearly empty and proceed as follow:
  - 1.Remove existing food and accessories baskets, unplug the appliance from the mains power and leave the doors open. Ventilate the room thoroughly to accelerate the process.
  2. When defrosting is completed, clean your freezer as described above.



## Warning

- Do not use sharp objects to remove frost from the freezer compartment.
- Only after the interior is completely dry should the appliance be switched back on and plugged back into the mains socket.

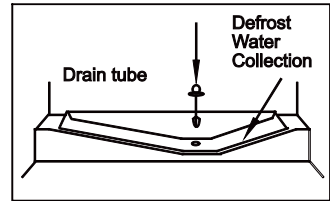

This compartment defrosts automatically

## Door seals cleaning

- Take care to keep door seals clean. Sticky food and drinks can cause seals to stick to the cabinet and tear when you open the door. Wash the seals with a mild detergent and warm water. Rinse and dry them thoroughly after cleaning.
- This product contains a light source of energy efficiency class G on the top of the refrigerating chamber.
- To replace the LED light, the below steps can be followed:

Replacing the LED light

  - 1.Unplug your appliance.
  - 2.Remove light cover by pushing up and out.
  - 3.Hold the LED cover with one hand and pull it with the other hand while pressing the connector latch.
  - 4.Replace LED light and snap it

## Defrosting



## Warning

The LED light must not be replaced by the user! If damaged, contact the customer helpline for assistance.

# Helpful hints and tips

## Energy saving tips

- We recommend that you follow the tips to save energy.
- Try to avoid keeping the door open for long periods in order to conserve energy.
  - Ensure the appliance is away from any sources of heat (Direct sunlight, electric oven or cooker etc.)
  - Don't set the temperature colder than necessary.
  - Don't store warm food or evaporating liquid in the appliance.
  - Place the appliance in a well ventilated, humidity free room. Please refer to the installing your new appliance chapter.
  - The description of appliance diagram shows the correct combination for the drawers, crisper and shelves, do not adjust the combination as this is designed to be the most energy efficient configuration.

## Hints for fresh food refrigeration

- Do not place hot food directly into the refrigerator or freezer, the internal temperature will increase resulting in the compressor having to work harder and will consume more energy.
- Do cover or wrap the food, particularly if it has a strong flavor.
- Place food properly so that air can circulate freely around it.

## Hints for refrigeration

- Meat (all Types) Wrap in polythene food: wrap and place on the glass shelf above the vegetable drawer. Always follow food storage times and use by dates suggested by manufacturers.
- Cooked food, cold dishes, etc: They should be covered and may be placed on any shelf.
- Fruit and vegetables: They should be stored in the special drawer provided.
- Butter and cheese: Should be wrapped in airtight foil or plastic film wrap.
- Milk bottles: Should have a lid and be stored in the door racks.

## Hints for freezing

- When first starting-up or after a period out of use, let the appliance run at least 2 hours on the higher settings before putting food in the compartment.
- Prepare food in small portions to enable it to be rapidly and completely frozen and make it possible to subsequently thaw only the quantity required.
- Wrap up the food in aluminum foil or polyethylene food wraps which are airtight.
- Do not allow fresh, unfrozen food to touch the food which is already frozen to avoid partial defrosting.

# Helpful hints and tips

- It is recommended to label and date each frozen package in order to keep track of the storage time.

## Hints for fresh food refrigeration

- Ensure that frozen food has been stored correctly by the food retailer .
- Once defrosted, food will deteriorate rapidly and should not be re-frozen.
- Do not exceed the storage period indicated by the food manufacturer.

## Switching off your appliance

- If the appliance needs to be switched off for an extended period, the following steps should be taken to prevent mould on the appliance.
  1. Remove all food.
  2. Remove the power plug from the mains socket.
  3. Clean and dry the interior thoroughly.
  4. Ensure that all the doors are wedged open slightly to allow air to circulate.

# Troubleshooting

If you experience a problem with your appliance or are concerned that the appliance is not functioning correctly, you can carry out some easy checks before calling for service, please see below. You can carry out some easy checks according to this section before calling for service.



## Warning

Don't try to repair the appliance yourself. If the problem persists after you have made the checks mentioned below, contact a qualified electrician, authorized service engineer or the shop where you purchased the product.

Problem	Possible cause & Solution
Appliance is not working correctly	Check whether the power cord is plugged into the power outlet properly.
	Check the fuse or circuit of your power supply, replace if necessary.



# Troubleshooting

Problem	Possible cause & Solution
Appliance is not working correctly	The ambient temperature is too low. Try setting the chamber temperature to a colder level to solve this problem.
	It is normal that the refrigerator is not operating during the automatic defrost cycle, or for a short time after the appliance is switched on to protect the compressor.
Odours from the compartments	The interior may need to be cleaned.
	Some food, containers or wrapping cause odours.
Noise from the appliance	<p>The sounds below are quite normal:</p> <ul style="list-style-type: none"> <li>• Compressor running noises.</li> <li>• Air movement noise from the small fan motor in the freezer compartment or other compartments.</li> <li>• Gurgling sound similar to water boiling. Popping noise during automatic defrosting.</li> <li>• Clicking noise before the compressor starts.</li> </ul>
	<p>Other unusual noises are due to the reasons below and may need you to check and take action:</p> <ul style="list-style-type: none"> <li>• The cabinet is not level.</li> <li>• The back of appliance touches the wall.</li> <li>• Bottles or containers knocking against each other.</li> </ul>
The motor runs continuously	<p>It is normal to frequently hear the sound of the motor, it will need to run more when in following circumstances:</p> <ul style="list-style-type: none"> <li>• Temperature setting is set colder than necessary.</li> <li>• Large quantity of warm food has recently been stored within the appliance.</li> <li>• The temperature outside the appliance is too high.</li> <li>• Doors are kept open too long or too often.</li> <li>• After your installing the appliance or it has been switched off for a long time.</li> </ul>

# Troubleshooting

Problem	Possible cause & Solution
A layer of frost occurs in the compartment	<p>Check that the air outlets are not blocked by food and ensure food is placed within the appliance to allow sufficient ventilation.</p> <ul style="list-style-type: none"> <li>• Ensure the door can be fully closed . To remove the frost, please refer to the cleaning and care chapter.</li> </ul>
Temperature inside is too warm	<p>You may have left the doors open too long or too frequently;</p> <ul style="list-style-type: none"> <li>• Or the doors are kept open by some obstacle;</li> <li>• Or the appliance is located with insufficient clearance at the sides, back and top.</li> </ul>
Temperature inside is too cold	<p>Increase the temperature by following the “Display controls” chapter.</p>
Doors can't be closed easily	<p>Check whether the top of the refrigerator is tilted back by 10-15mm to allow the doors to self close, or if something inside is preventing the doors from closing.</p>
Water drips on the floor	<p>The water pan (located at the rear bottom of the cabinet) may not be properly leveled, or the draining spout underneath the top of the compressor depot may not be properly positioned to direct water into this pan, or the water spout is blocked , or the water is not fully inserted into the connector.</p> <ul style="list-style-type: none"> <li>• You may need to pull the refrigerator away from the wall to check the pan and spout and connector.</li> <li>• Check if the refrigerator is power-off for a long time, this may cause the ice in the bucket to melt into water, and flow to the floor.</li> </ul>
The light is not working	<ul style="list-style-type: none"> <li>• the LED light may be damaged. Refer to replace LED lights in cleaning and care chapter.</li> <li>• the control system has disabled the lights due to the door being kept open too long, close and reopen the door to reactivate the lights.</li> </ul>

# Troubleshooting

<b>Problem</b>	<b>Possible cause &amp; Solution</b>
Unable to connect appliance to Wi-Fi network	<ul style="list-style-type: none"><li>• Is the password for home Wi-Fi network was entered correctly? Make sure the password is correct and connect again.</li><li>• Is the home Wi-Fi router frequency is 2.4GHz? The appliance only supports 2.4GHz radio frequency. Set up a dedicated 2.4GHz Wi-Fi SSID and connect the appliance to it.</li><li>• Are the router and appliance kept far apart causing the poor network? Consider either moving the router closer to the appliance or purchasing Wi-Fi range extender and installing it.</li></ul>
You can hear water bubbling in the refrigerator	<ul style="list-style-type: none"><li>• This is normal. The bubbling comes from the refrigerant coolant liquid circulating through the refrigerator.</li></ul>

# Disposal of the appliance

It is prohibited to dispose of this appliance as household waste.

## Packaging materials

Packaging materials with the recycle symbol are recyclable. Dispose of the packaging into a suitable waste collection container to recycle it.

## Before disposal of the appliance

1. Pull out the mains plug from the mains socket.
2. Cut off the power cord and discard with the mains plug



### Warning

- Refrigerators contain refrigerant and gases in the insulation. Refrigerant and gases must be disposed of professionally as they may cause eye injuries or ignition. Ensure that tubing of the refrigerant circuit is not damaged prior to proper disposal.
- Food needs to be packed in bags before putting into the refrigerator, and liquids need to be packed in bottles or capped containers to avoid the problem that the product design structure is not easy to clean.

	<b>Correct Disposal of this product</b>
	<p>This marking indicates that this product should not be disposed of with other household wastes throughout the EU. To prevent possible harm to the environment or human health from uncontrolled waste disposal, recycle it responsibly to promote the sustainable reuse of material resources. To return your used device, please use the return and collection systems or contact the retailer where the product was purchased. They can take this product for environmental safe recycling.</p>

# Disposal of the appliance

To avoid contamination of food, please respect the following instructions

- Opening the door for long periods can cause a significant increase of the temperature in the compartments of the appliance.
- Clean regularly surfaces that can come in contact with food and accessible draining systems.
- Store raw meat and fish in suitable containers in the refrigerator, so that it is not in contact with or drip onto other food.
- Two-star frozen-food compartments are suitable for storing pre-frozen food, storing or making ice cream and making ice cubes.
- One-, two- and three-star compartments are not suitable for the freezing of fresh food.

Order	Compartments type	Target storage temp.[°C]	Appropriate food
1	Fridge	+2~+8	Eggs, cooked food, packaged food, fruits and vegetables, dairy products, cakes, drinks and other foods which are not suitable for freezing.
2	***-Freezer	≤-18	Seafood (fish, shrimp, shellfish), freshwater aquatic products and meat products (recommended for 3 months, the longer the storage time, the worse the taste and nutrition), are not suitable for frozen fresh food.



## Note

please store different foods according to the compartments or target storage temperature of your purchased products.

- If the refrigerating appliance is left empty for long periods, switch off, defrost, clean, dry, and leave the door open to prevent mould developing within the appliance.

**Customer support line (for UK mainland and Northern Ireland only) : 0191 387 0804,**  
**Southern Ireland customers please contact your Retailer.**



**Hisense UK Ltd**

Ground floor Munroe Court

White Rose Office Park

Millshaw Park Lane

Leeds LS11 0EA