

Battery Replacement, Removal and Disposal

Battery Replacement

For battery replacement the entire, intact clipper/ trimmer should be sent to: Wahl (UK) Ltd Customer Services (the address can be found on the reverse of this booklet) or taken to a suitably qualified professional. The battery should only be replaced by the original manufacturers spare.

Battery Removal and Recycling

At the end of its life, when it will no longer take a full charge, the battery in your clipper/ trimmer must be removed and recycled/disposed of correctly. Batteries should be disposed of at an official collection point separately from the clipper/ trimmer. If you are having trouble removing the battery you can also return the product to Wahl (UK) Ltd Customer Services who will dispose of it in an environmentally safe way.

To remove the battery follow these steps:

1. Unplug the transformer from the outlet, disconnect from trimmer and allow the batteries to completely run down before disassembly.
2. Remove the blade by pushing on the teeth away from the trimmer head
3. Use a Philips screwdriver to remove the 2 screws from the housing under the blade. (Fig A)
4. Using a small flat bladed screwdriver prise the on off switch and white cover plate away from the top housing of the clipper, this will reveal 3 screws, remove the 3 Philips screws. (Fig B)
5. Using a flat bladed screwdriver prise the housing apart
6. Cut the two tags on the end of the battery and remove the battery
7. Apply tape to both terminals of the battery before recycling/disposing.

WAHL CLIPPER CORPORATION
World Headquarters
P.O. Box 578. Sterling, IL 61081

Wahl (UK) Ltd.
Heme Bay Trade Park
Sea Street Heme Bay, Kent
CT6 8JZ England

© 2016 Printed in China
Wahl® is a registered trademark
of Wahl Clipper Corporation

95820-301
Rev0 09-16

WAHL®

Model/Type 9649



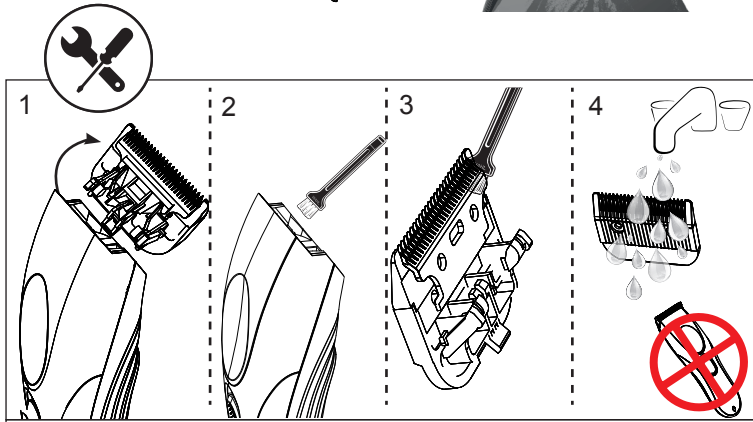
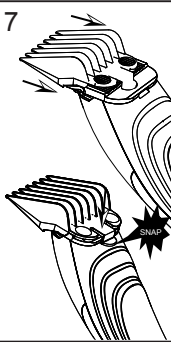
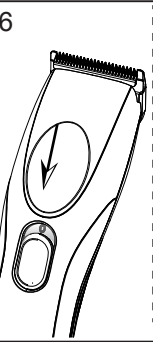
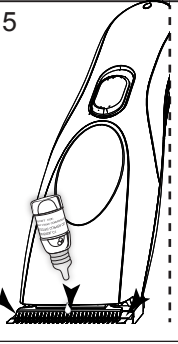
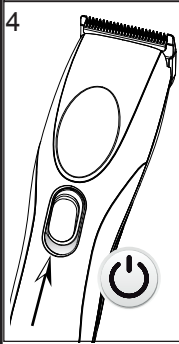
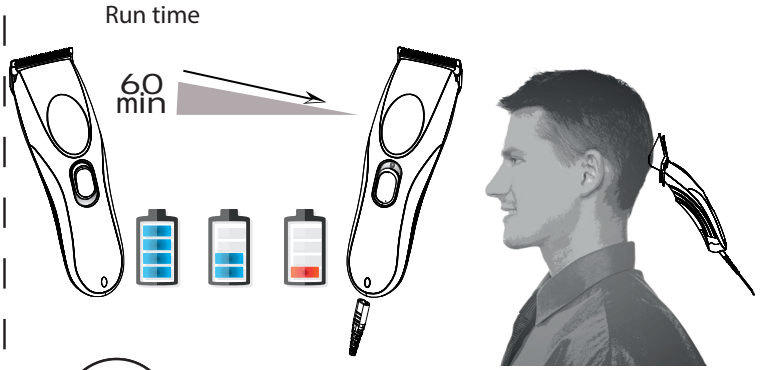
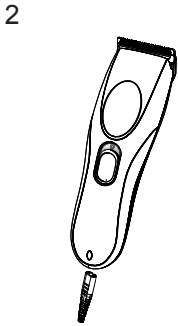
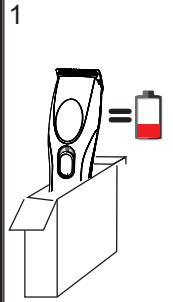

Cutting lengths

