



# WICKED

75681



LEGO® Builder



LEGO.com/sustainable-packaging



FR  
**DONNEZ**  
OU  
**RECYCLEZ**



OU



OU



ASSOCIATION

MAGASIN

DÉCHÈTERIE

Adresses sur [quefairedemesdechets.fr](http://quefairedemesdechets.fr)

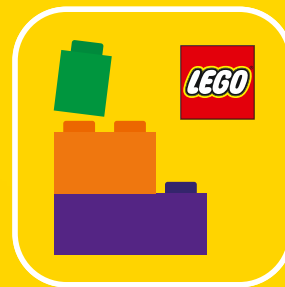

🔍 LEGO® Builder

# BUILDER

Download on the  
App Store

GET IT ON  
Google Play

腾讯应用宝  
安卓应用商店

Apple and the Apple logo are trademarks of Apple Inc., registered in the U.S. and other countries and regions. App Store is a service mark of Apple Inc. Google Play and the Google Play logo are trademarks of Google LLC. Tencent and the Tencent logo are trademarks of Tencent Inc.

🔍 [LEGO.com/devicecheck](https://LEGO.com/devicecheck)

EN Ask parents' permission before going online | DE Eltern um Erlaubnis bitten, bevor du online gehst | FR Demande l'autorisation d'un parent avant d'aller en ligne | IT Chiedi il permesso ai tuoi genitori prima di andare online | ES Pídeles permiso a tus papás antes de conectarte a Internet | PT Peça autorização aos pais antes de acederes online | ZH 上网前应先征得父母的同意 | PL Poproś rodziców o zgodę, zanim wejdiesz do Internetu | CS Než půjdeš na internet, požádej rodiče o svolení | SK Skôr než pôjdeš na internet, vypýtaj si povolenie od rodičov | HU Kérj szülői engedélyt, mielőtt online csatlakoznál! | RO Cere permisiunea părinților înainte de a te conecta online | BG Поискайте разрешение от родител, преди да влезете онлайн | LV Pirms došanās tiešsaistē palūdz atļauju vecākiem | ET Enne Interneti kasutamist küsi vanematelt luba | LT Prieš prisijungdami prie interneto, atsklauskite tėvų

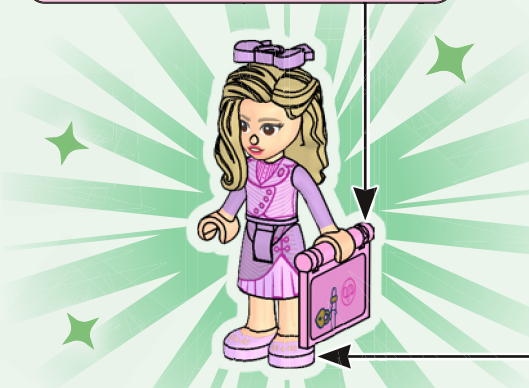
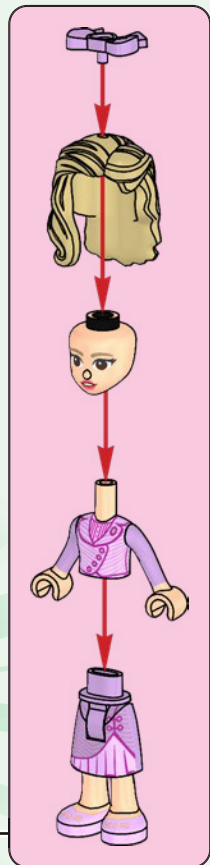
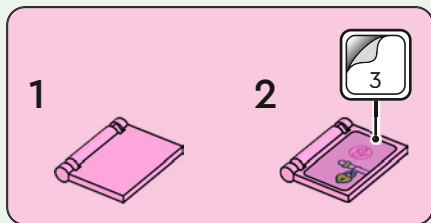
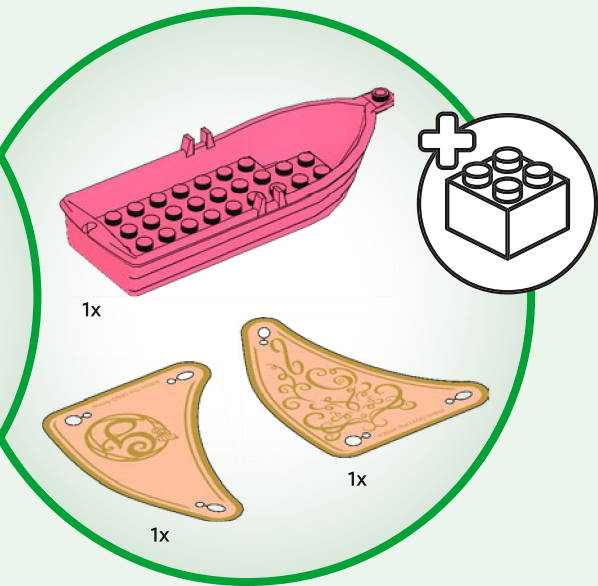

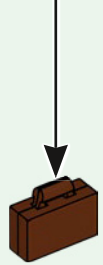
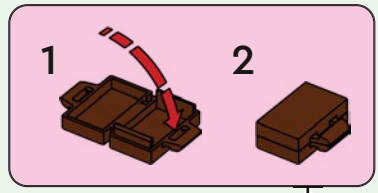
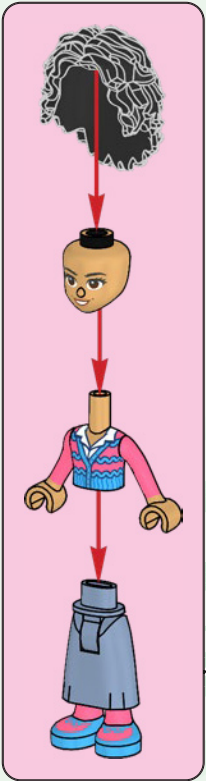
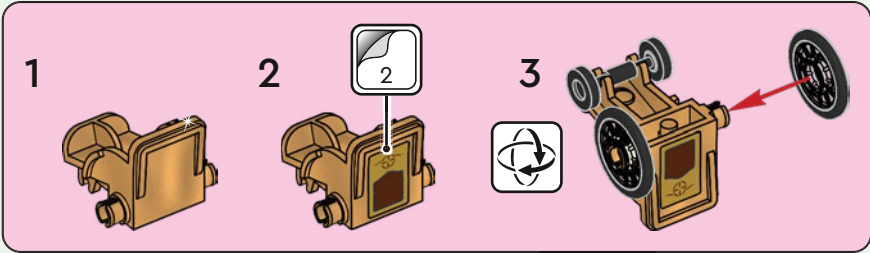

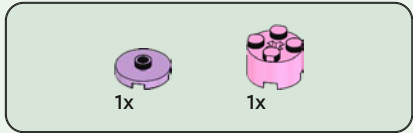
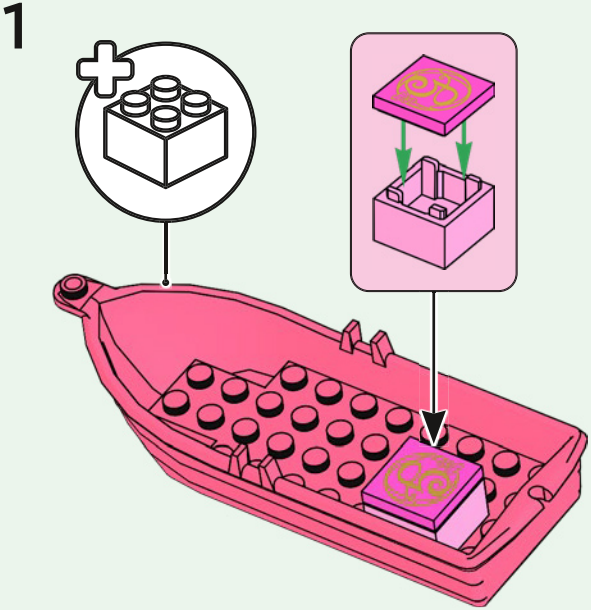
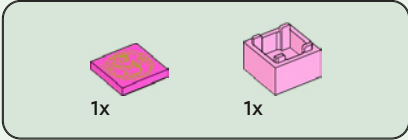
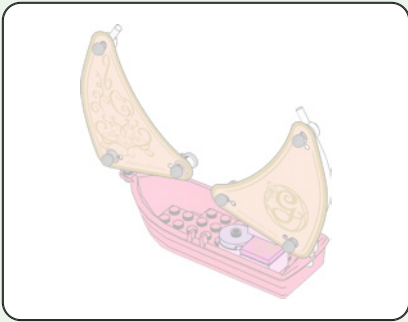

2

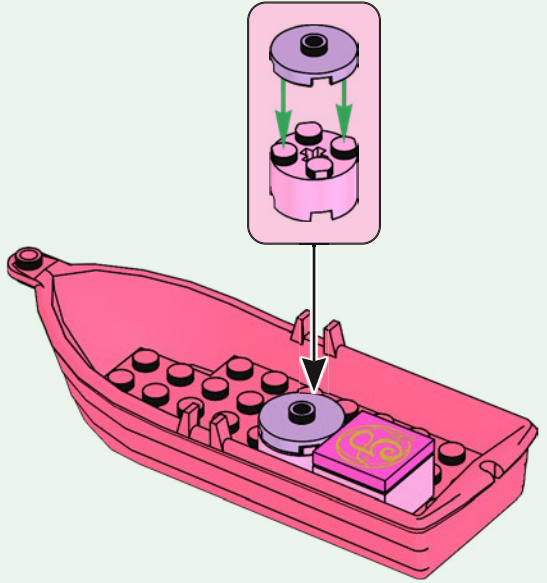

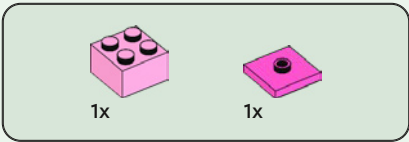

3

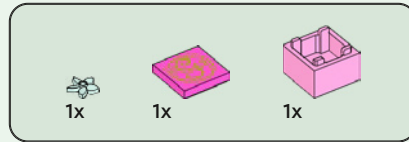
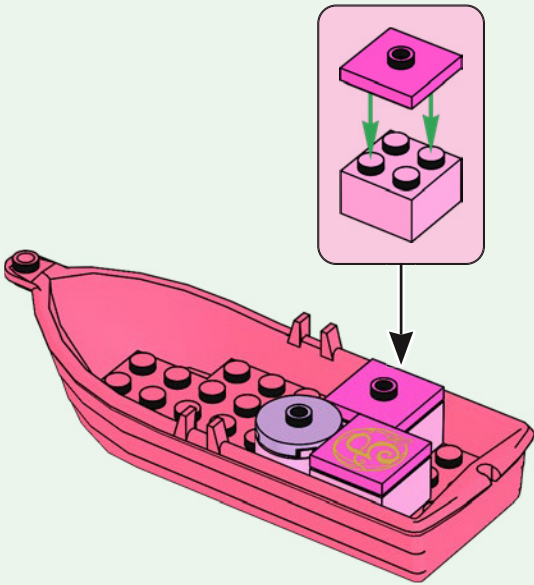

4

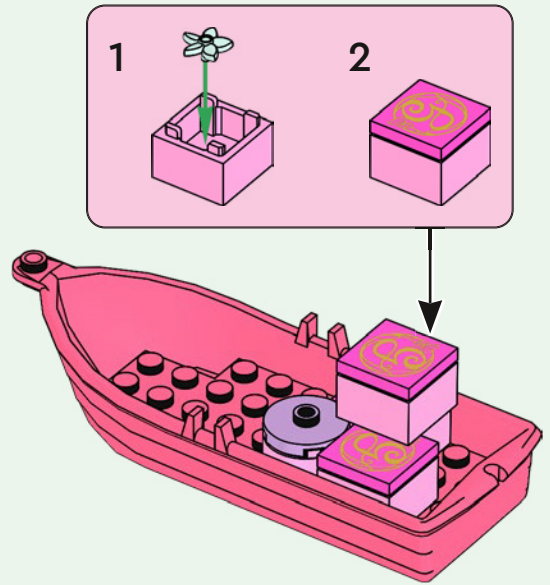

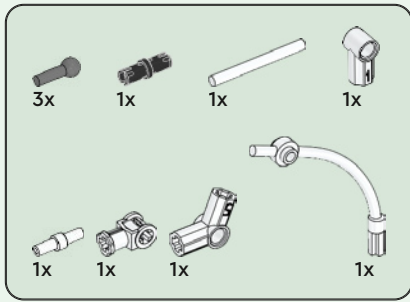

5

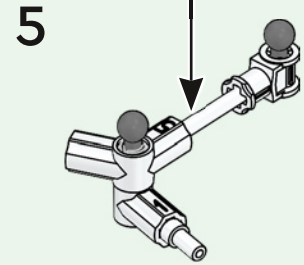
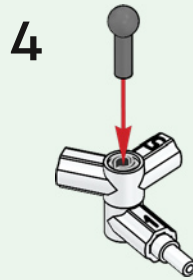
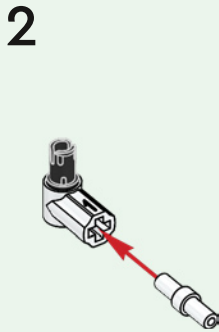
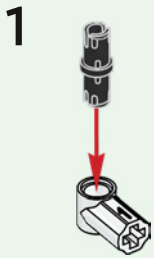
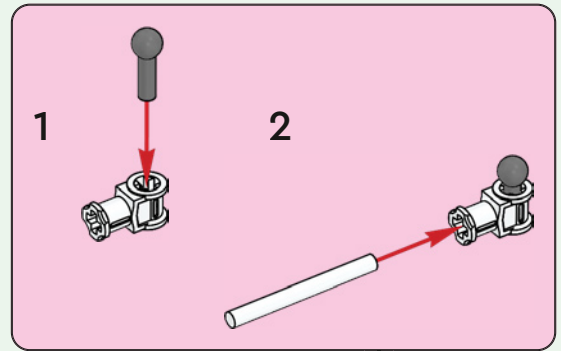



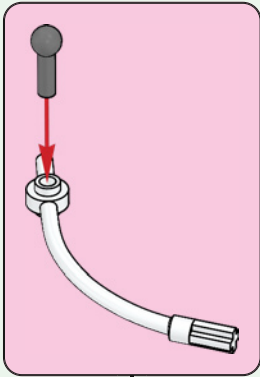

6

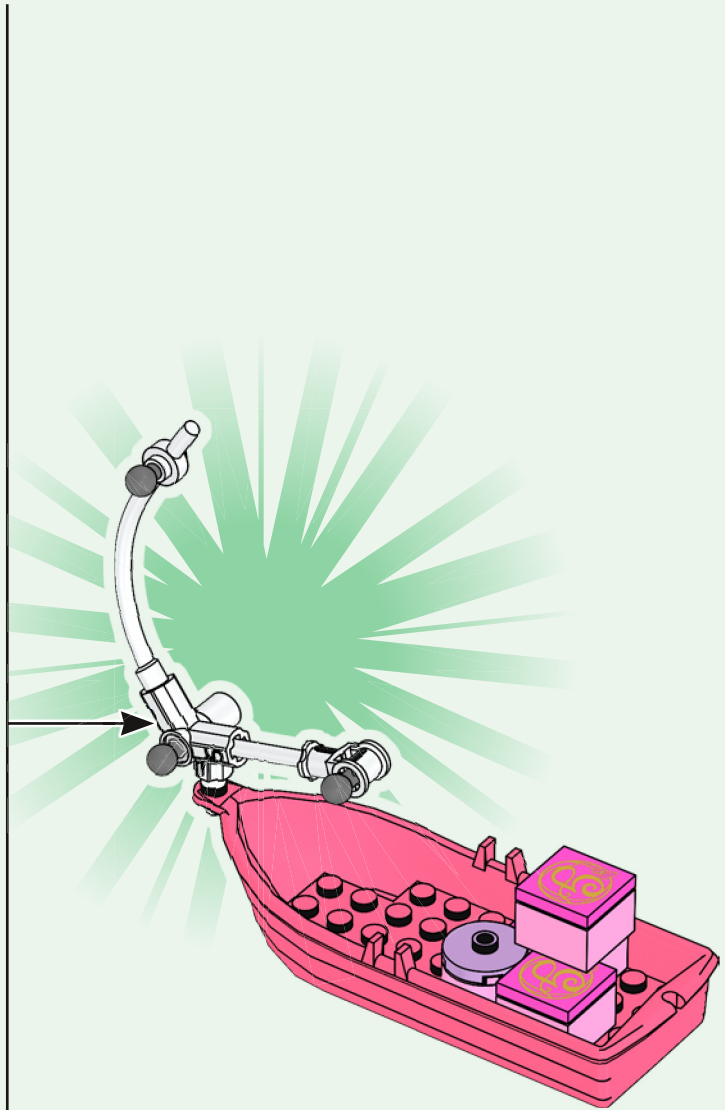
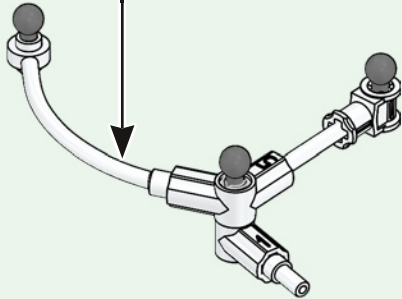

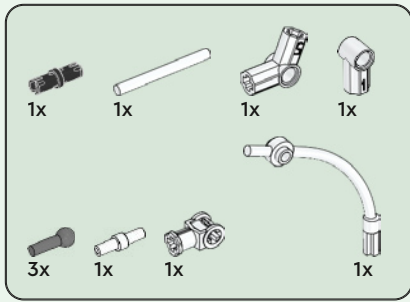

6

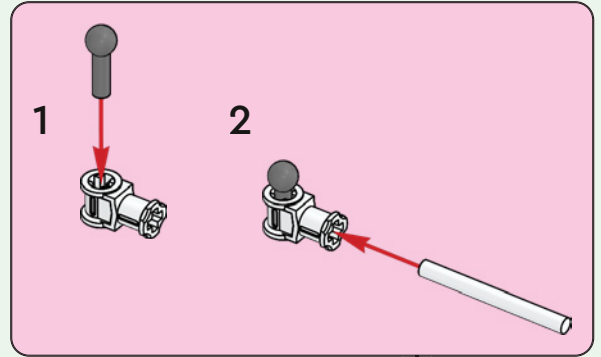

1



2

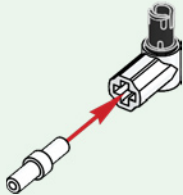

3

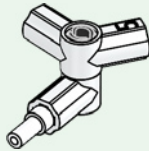

4

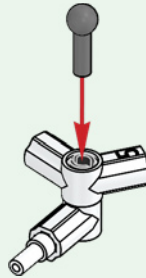

5

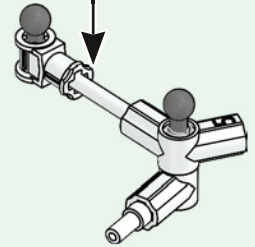

6

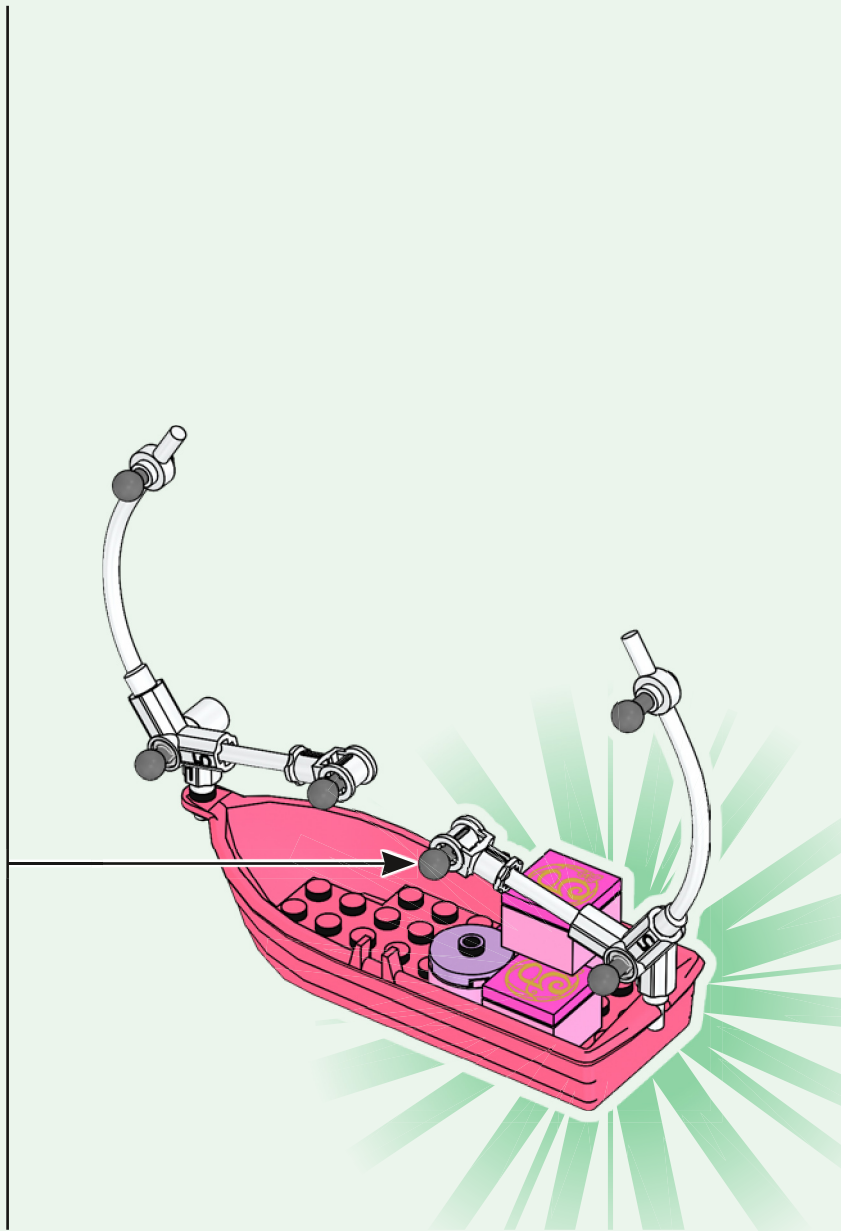
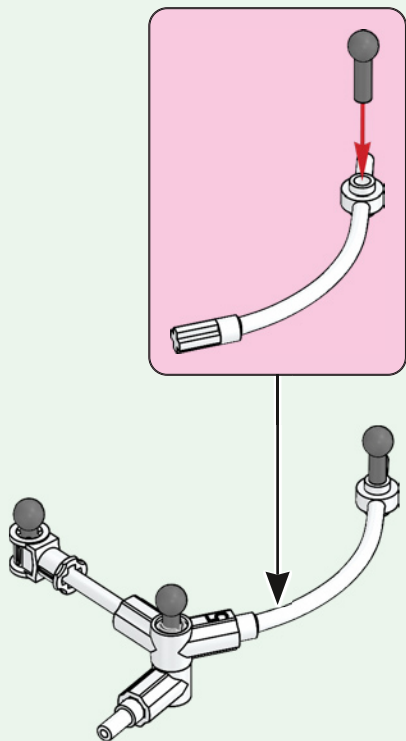

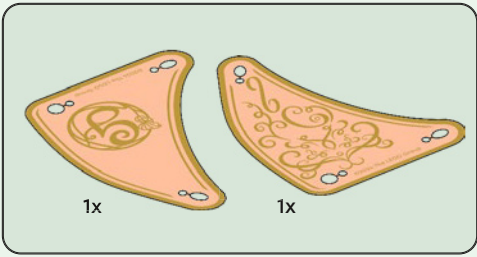

7

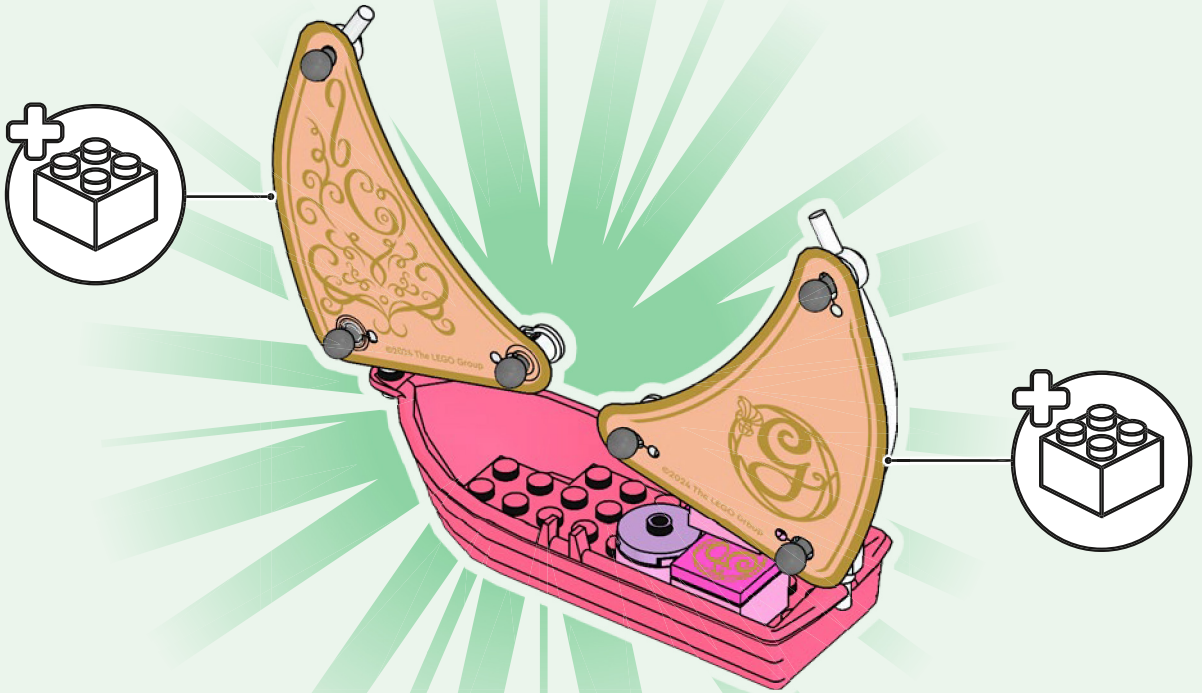

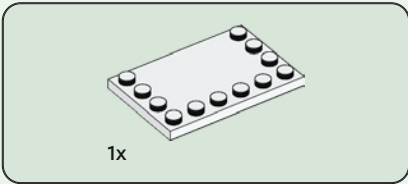
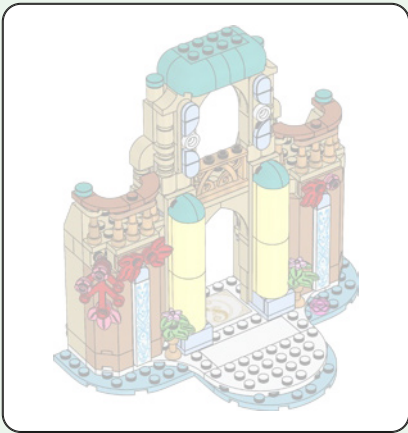

1

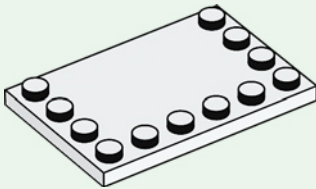

2



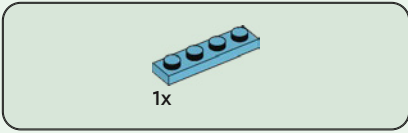

3

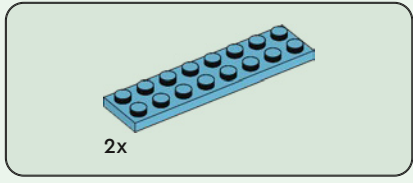
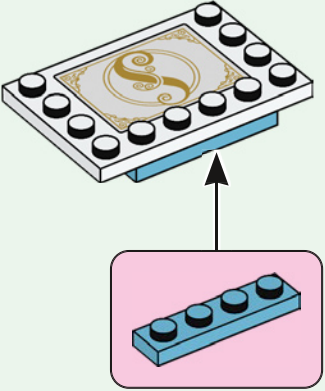

4

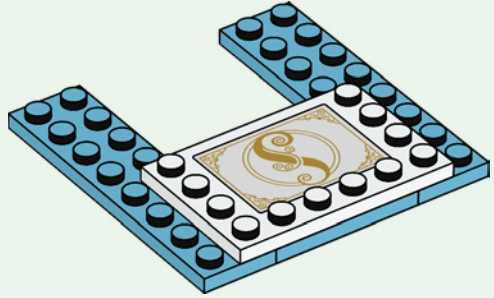

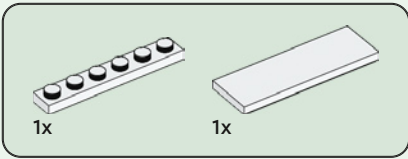

5

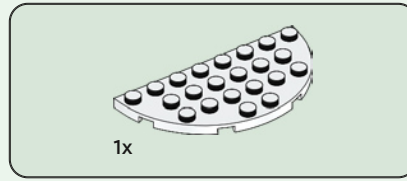
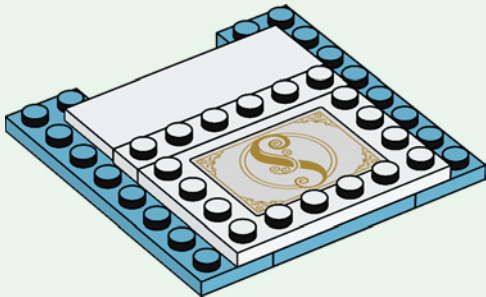

6

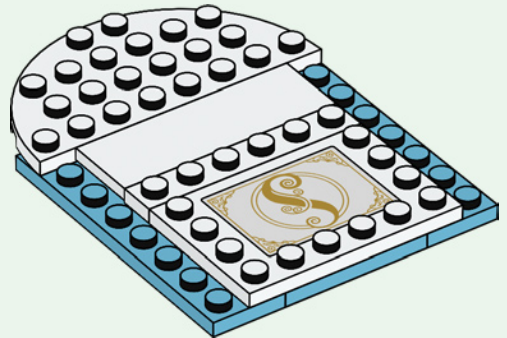

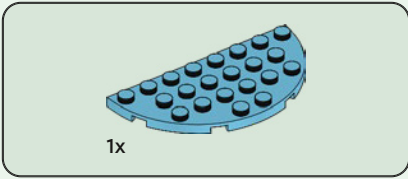

7

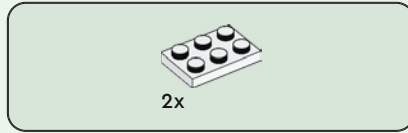
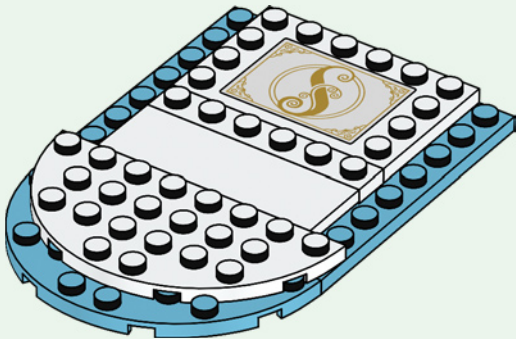

8

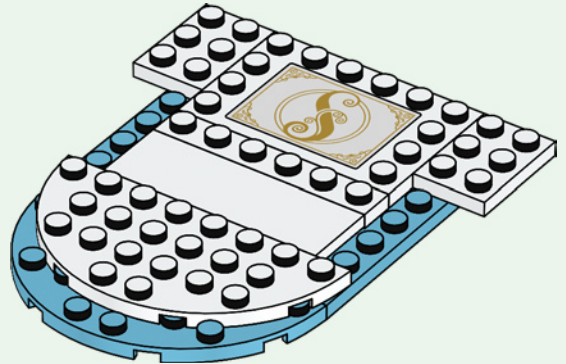



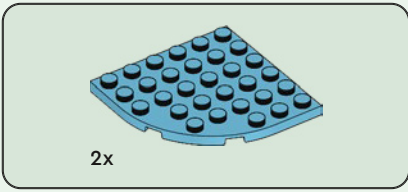

9

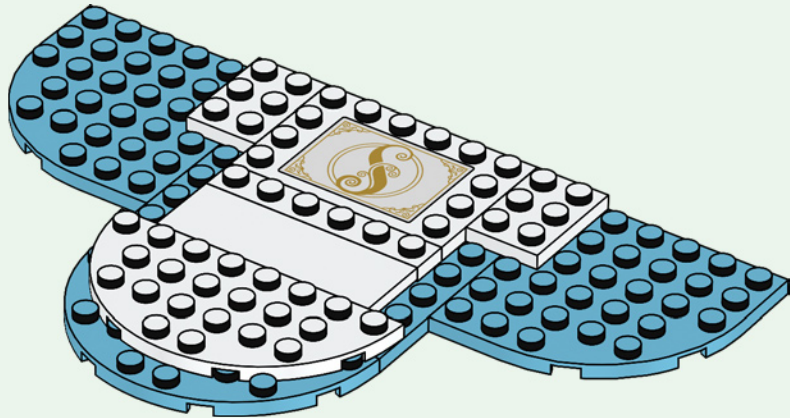



2x

10

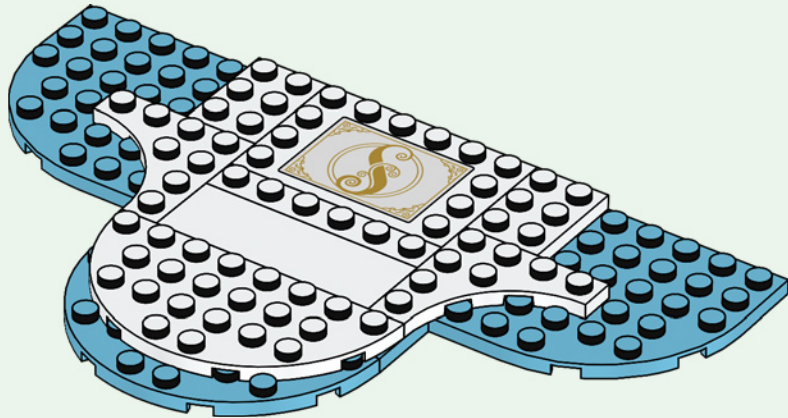

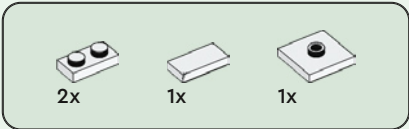

11

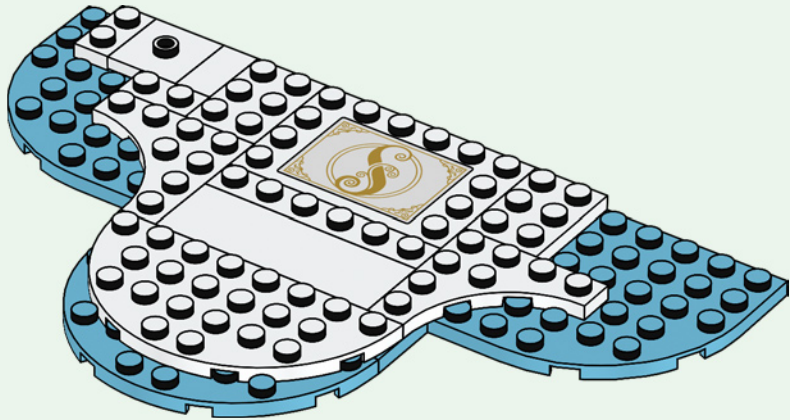



1x

12

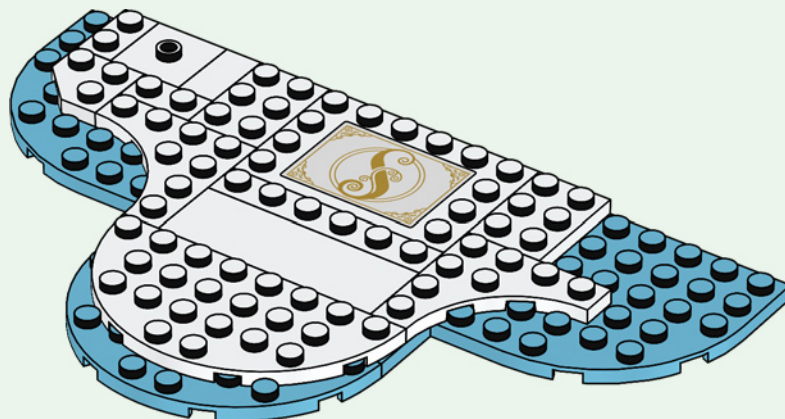

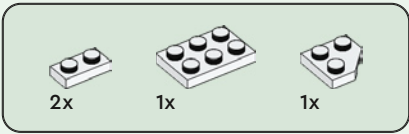

13

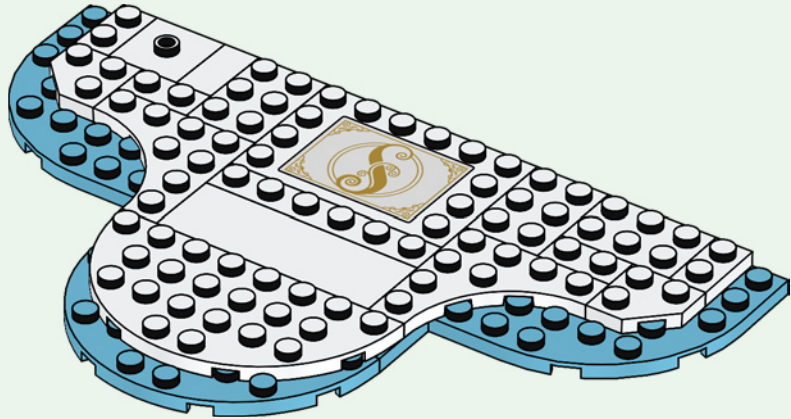

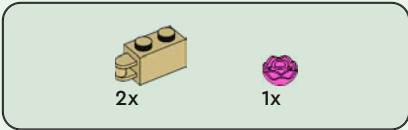

14

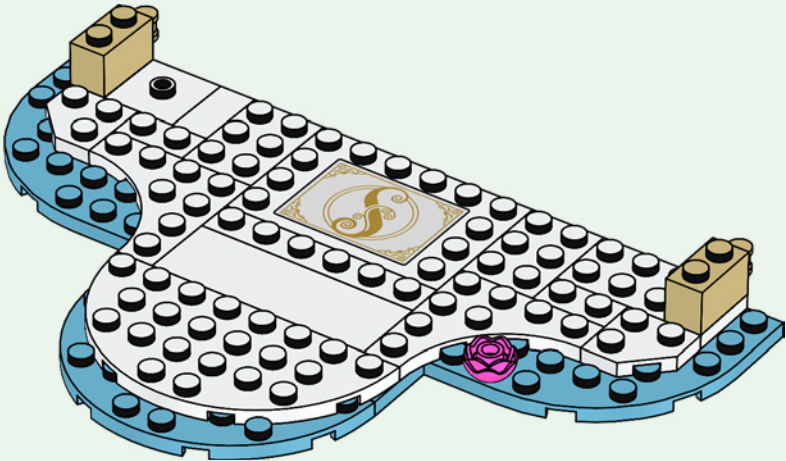



2x



4x

15

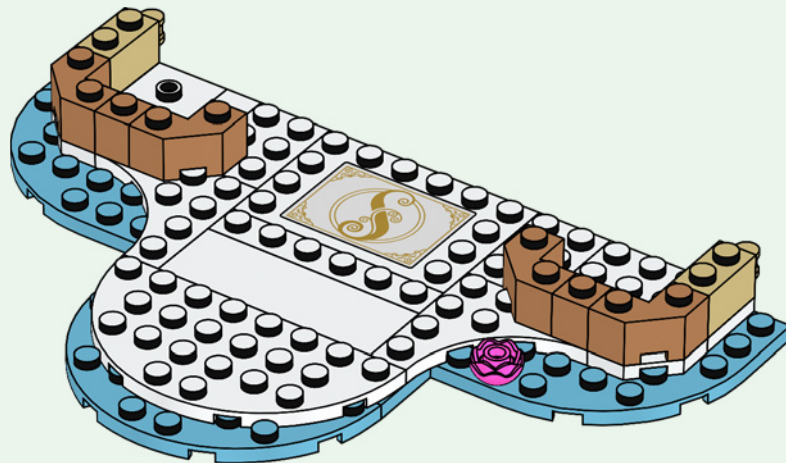

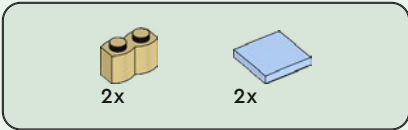

16

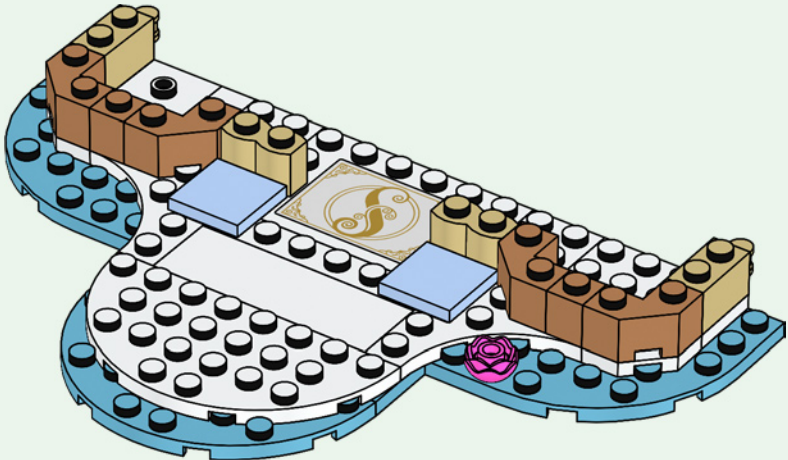





2x

17

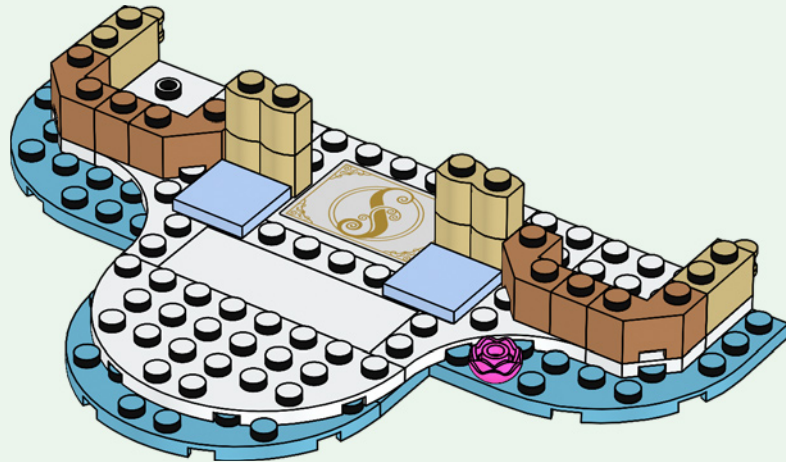



2x

18





2x



2x

19

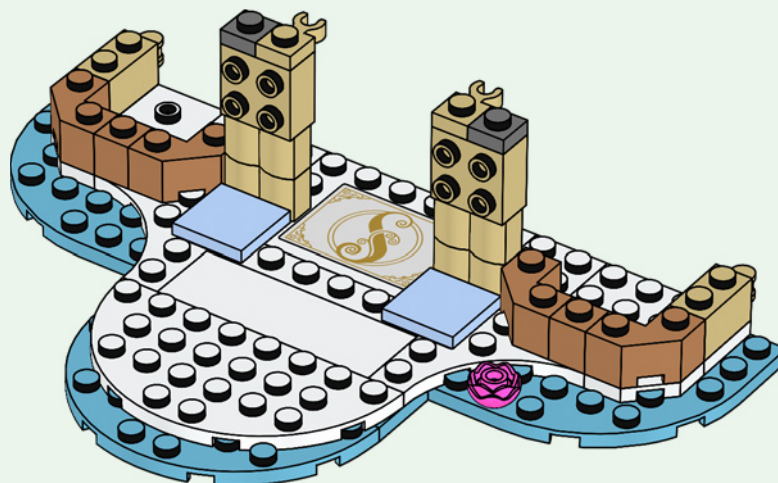

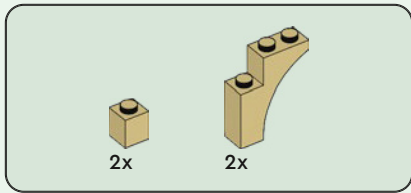

20

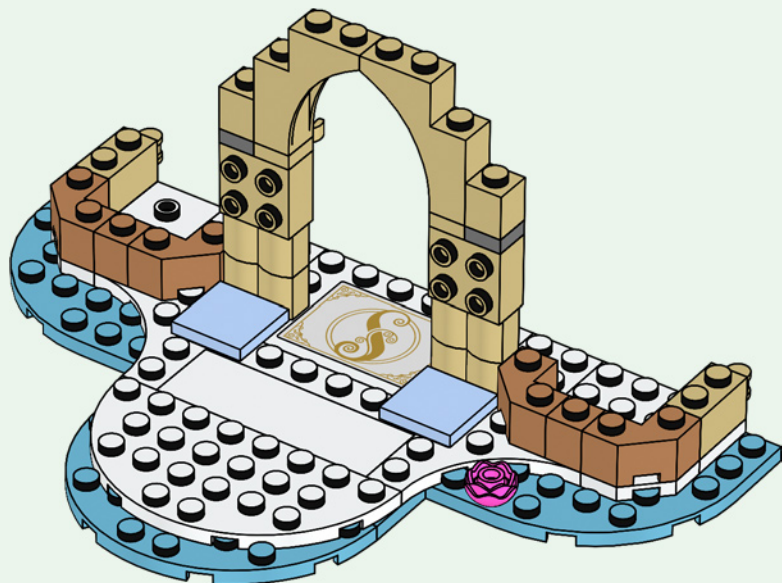



1x

21

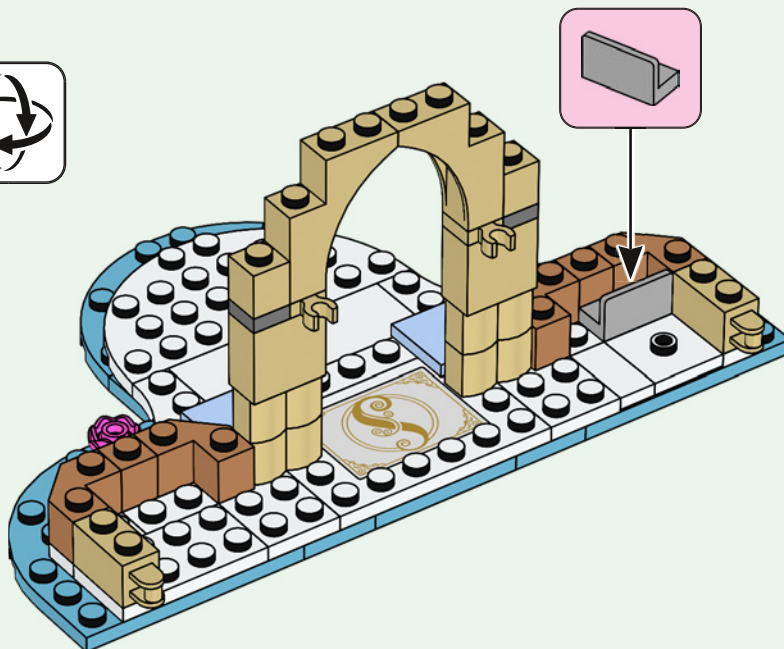

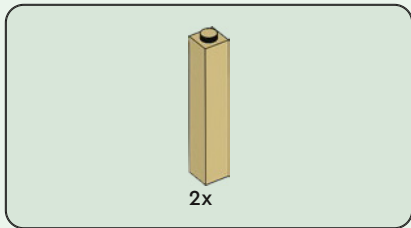

22

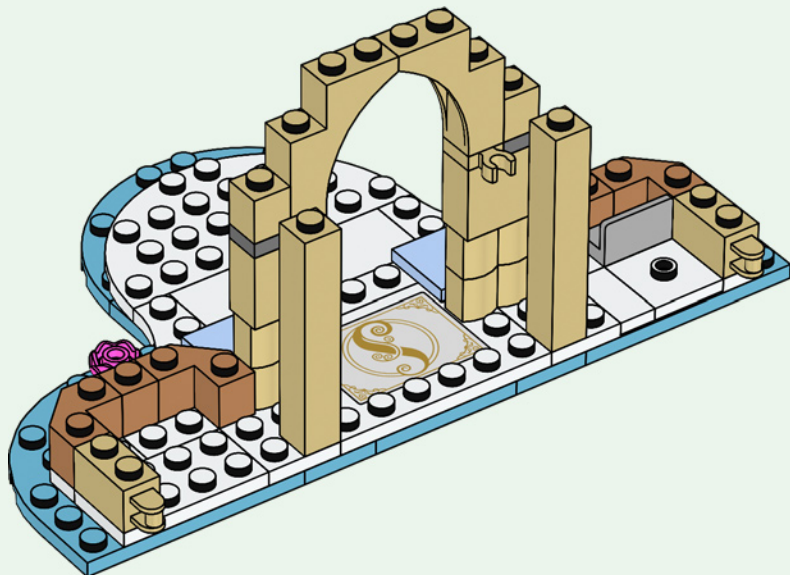



2x

23

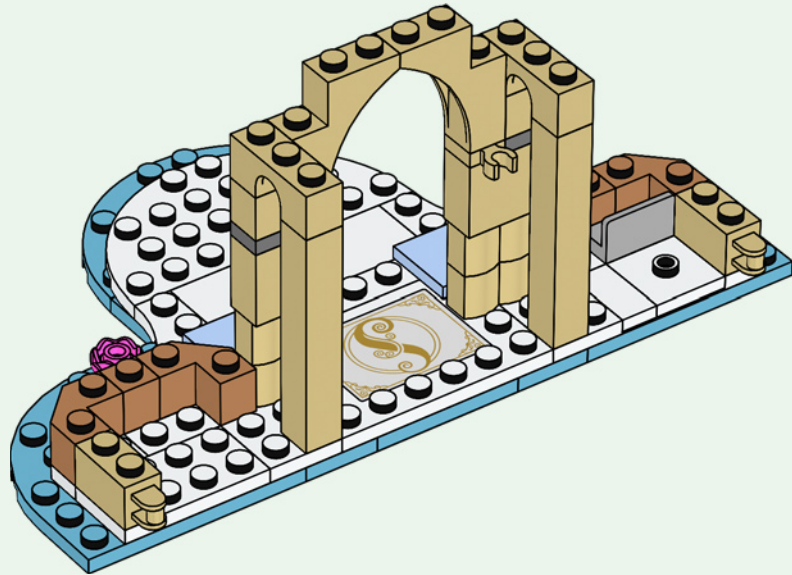



2x

24

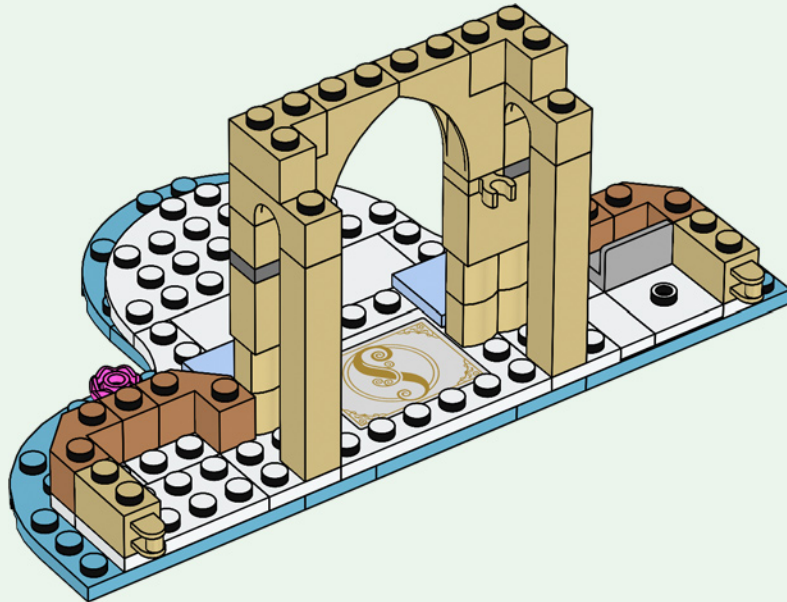



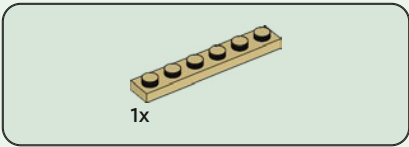

25

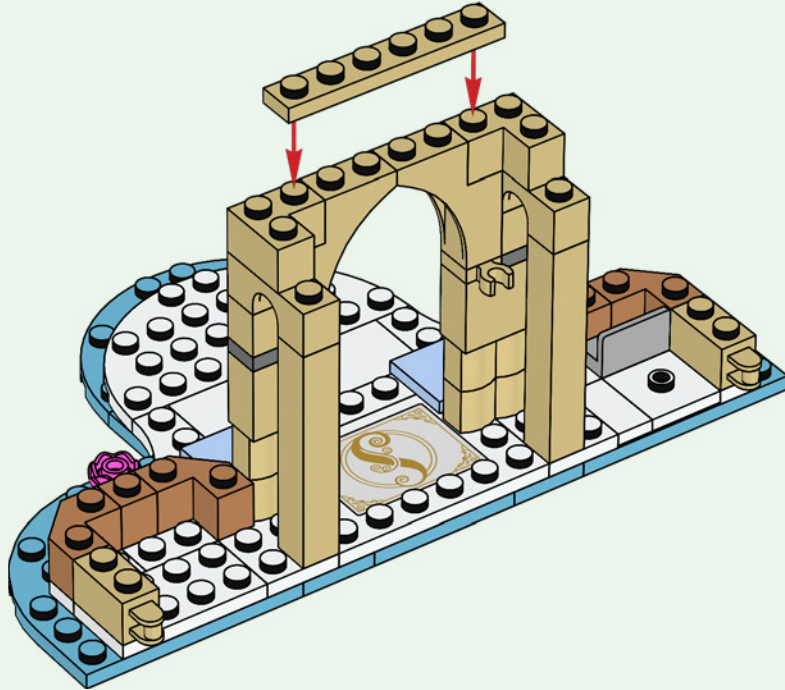



2x



2x

26

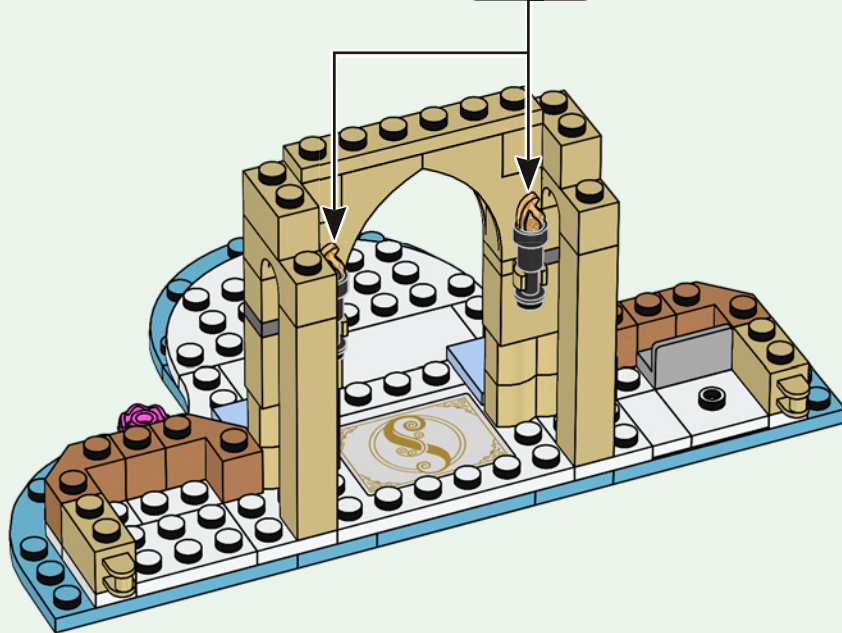
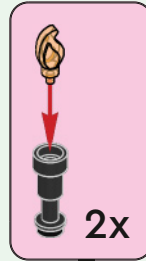



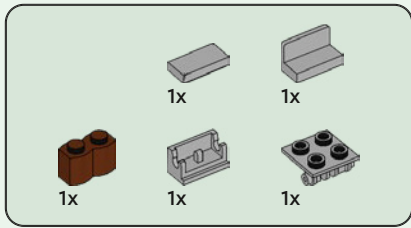

27

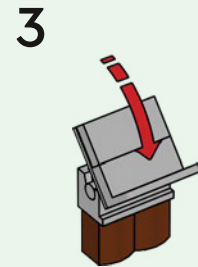
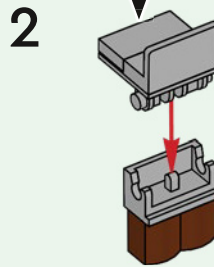
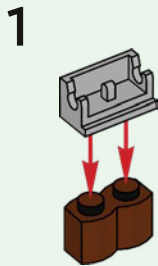
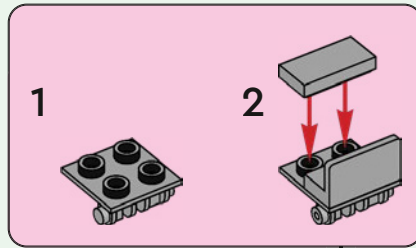

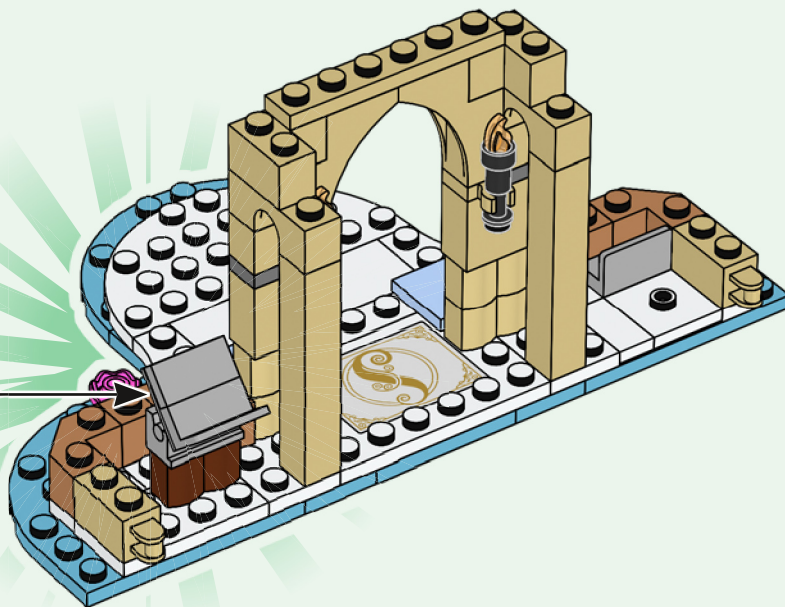



1x

28



2x

29

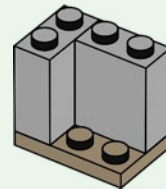



30

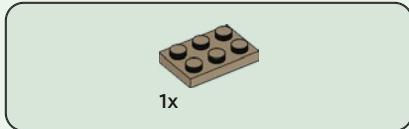
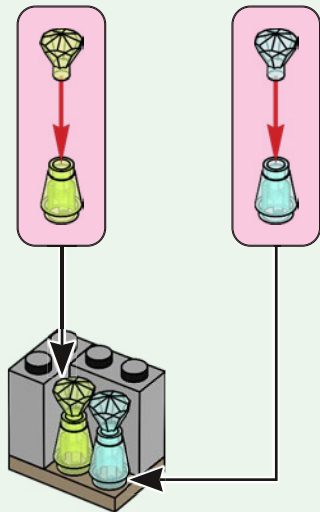

31





1x

32





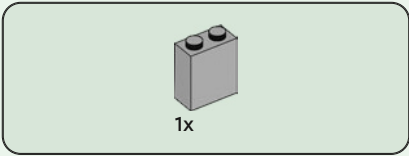

33

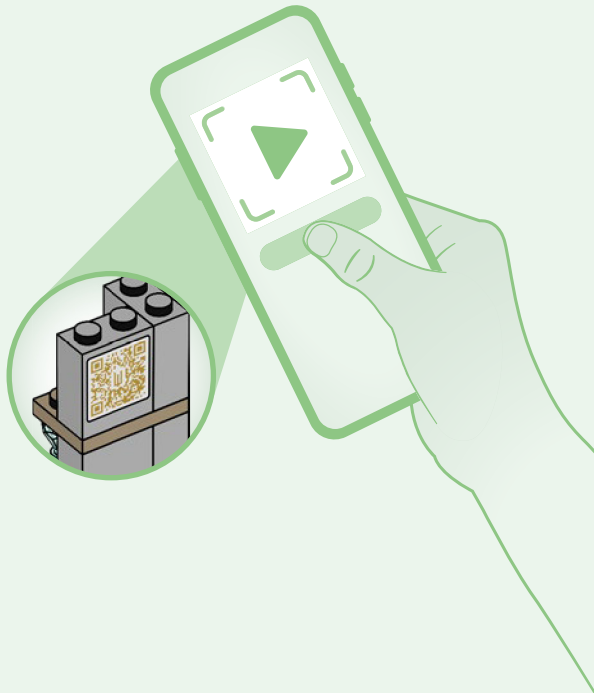
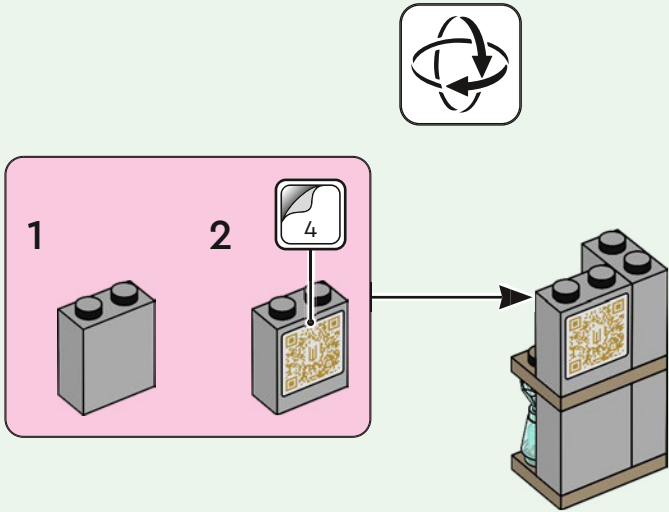

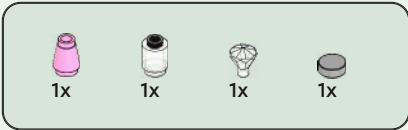

34

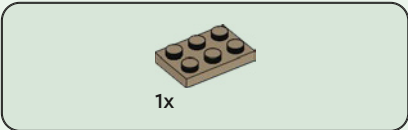
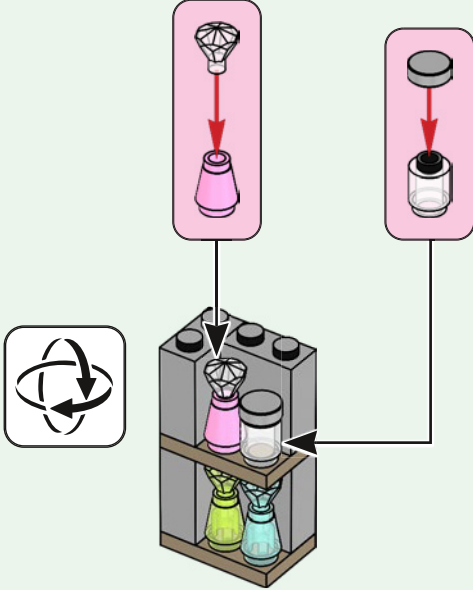

35



36

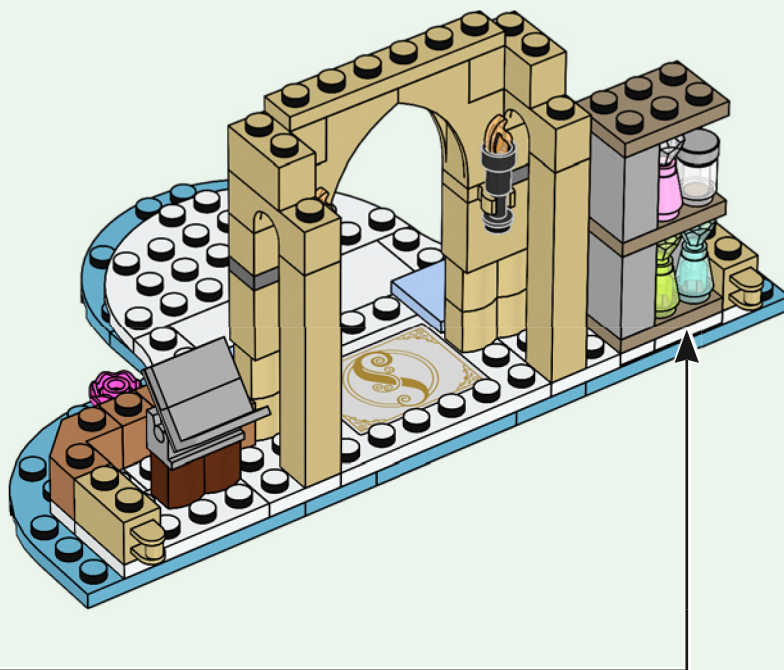

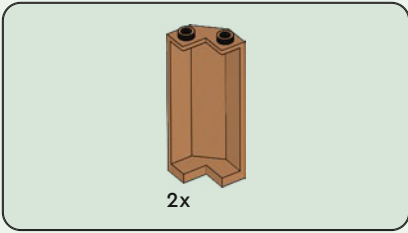

37

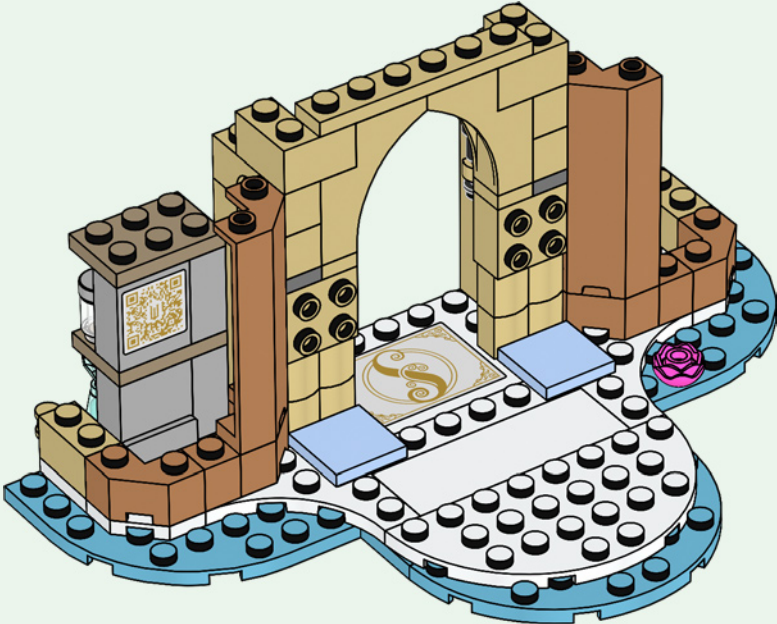

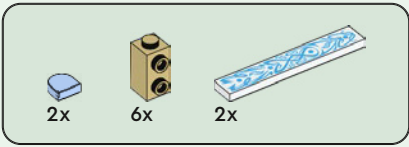

38

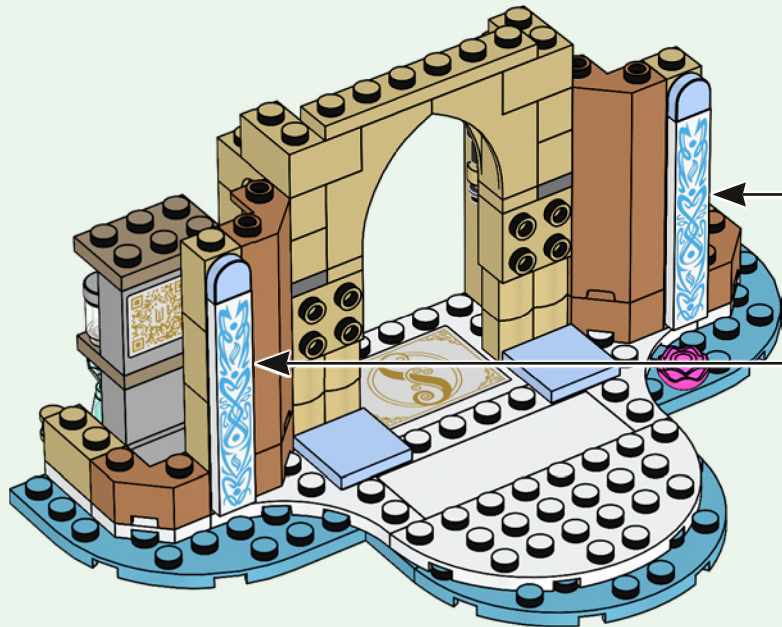
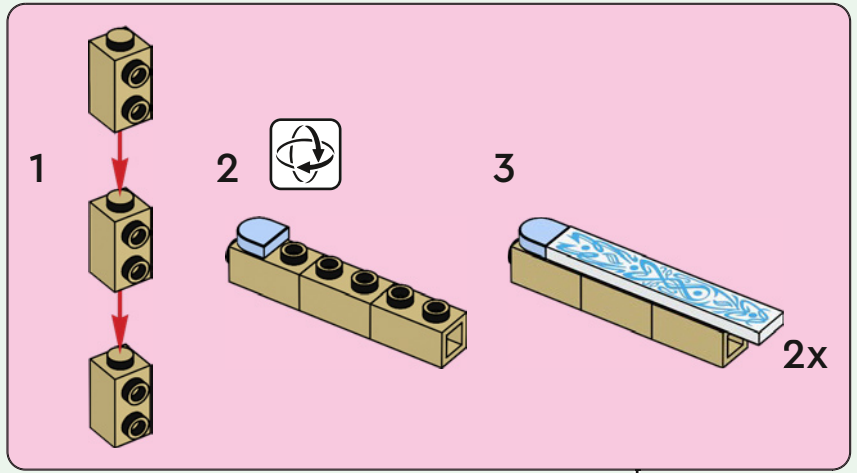

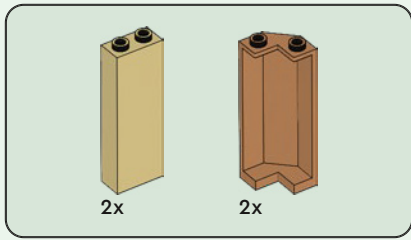

39

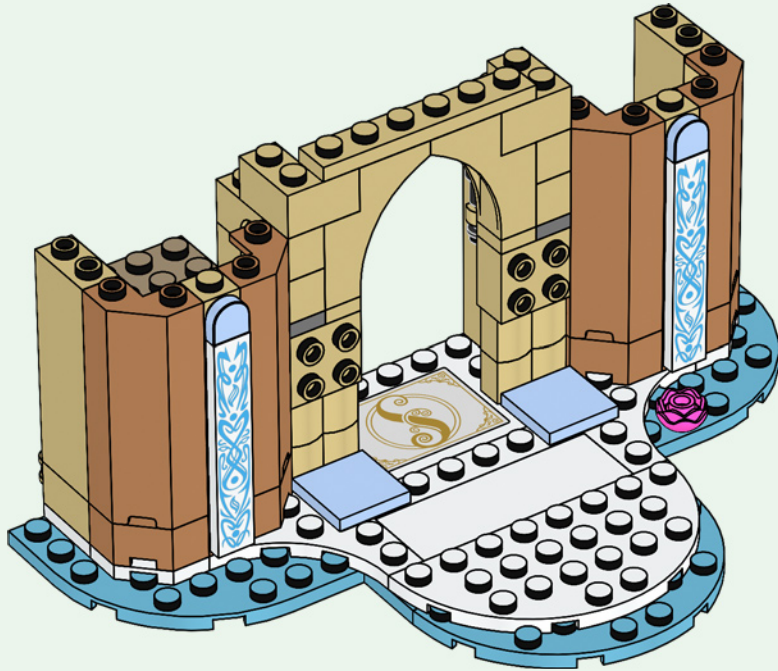

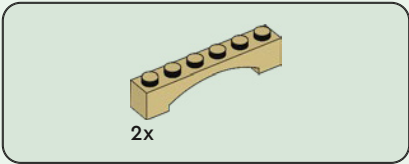

40

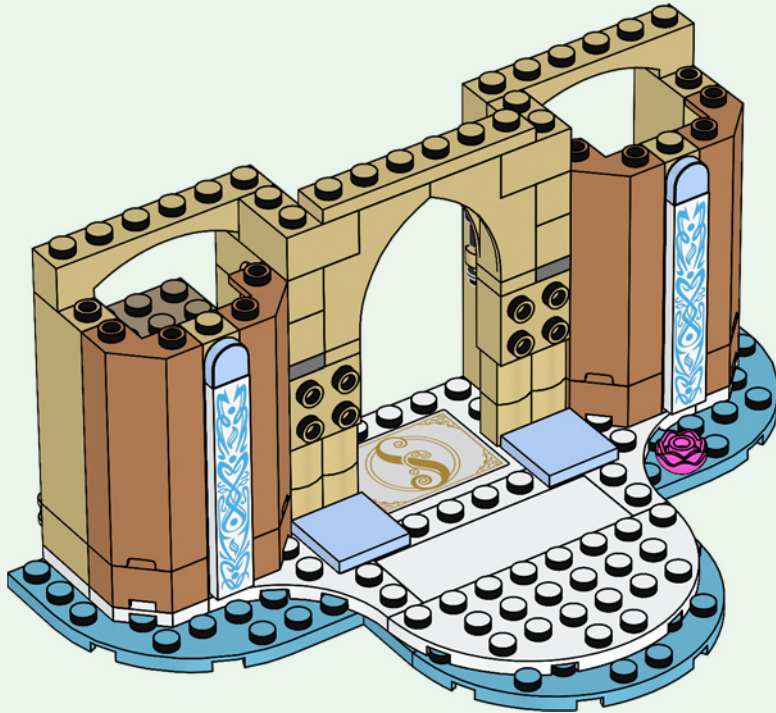



2x

41

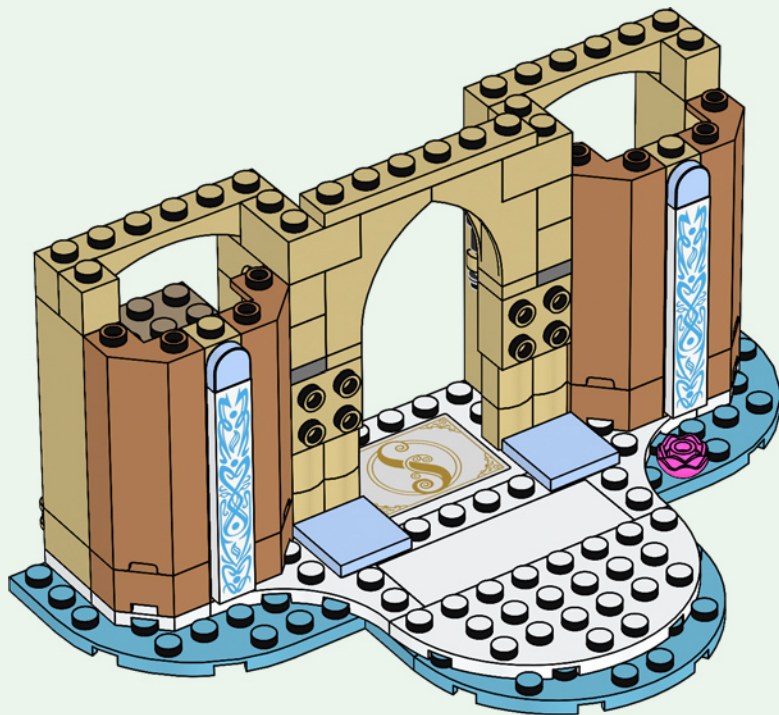





4x

42

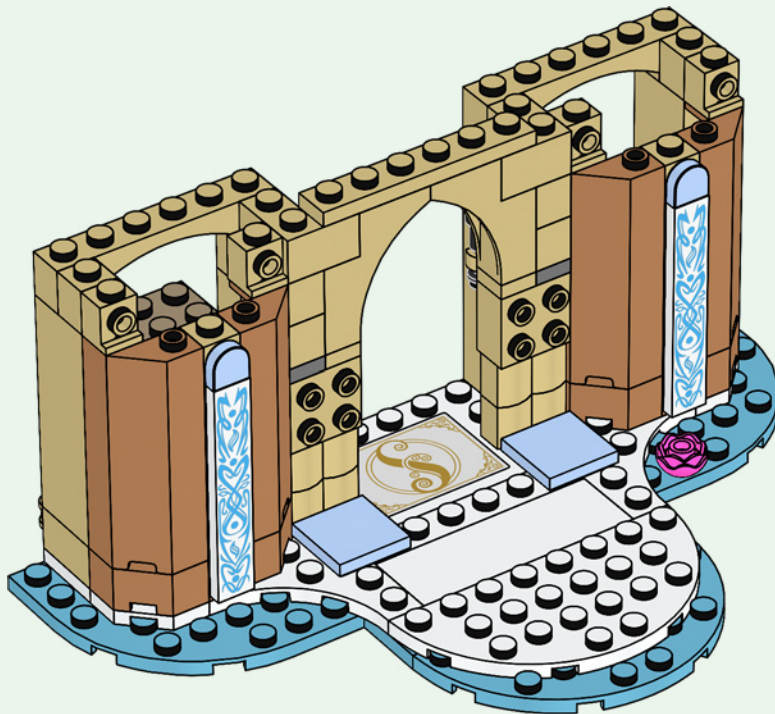



6x

43

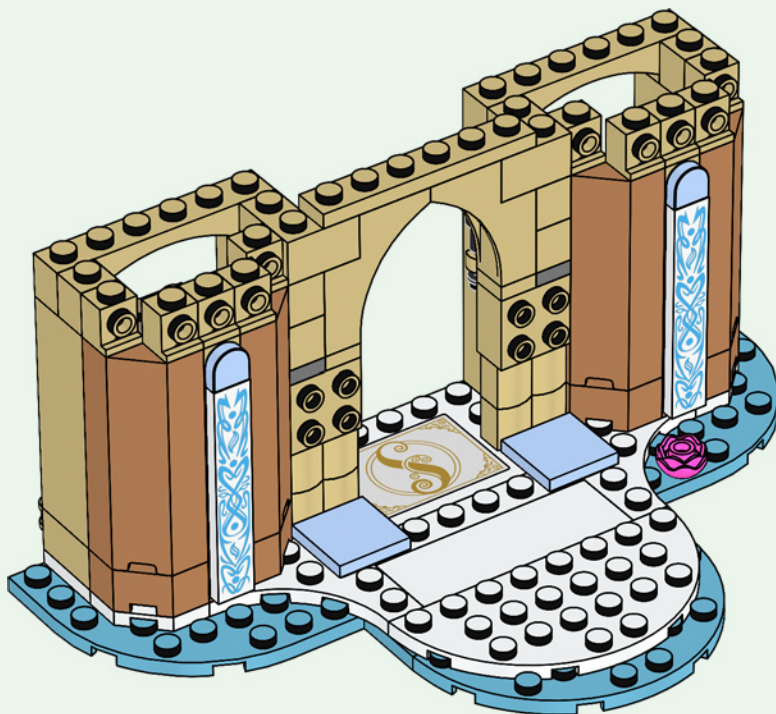

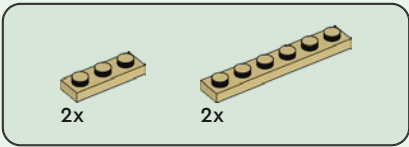

44

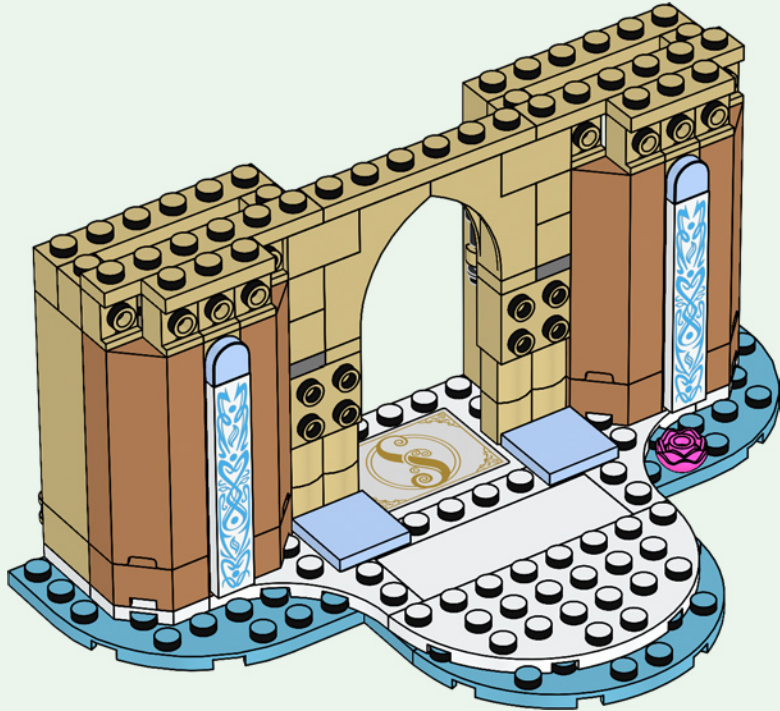

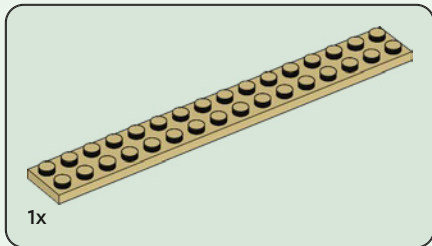

45

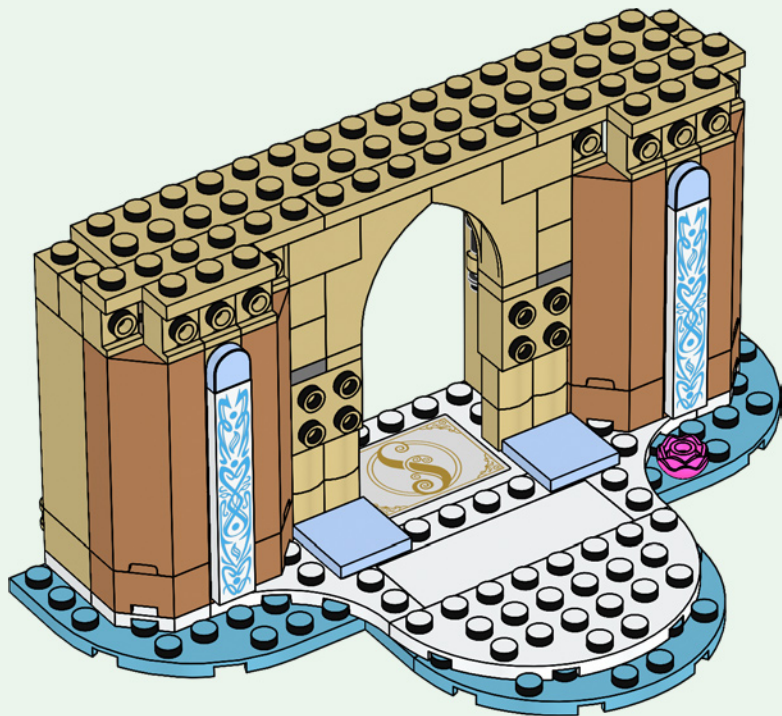



3x

# 46



3x

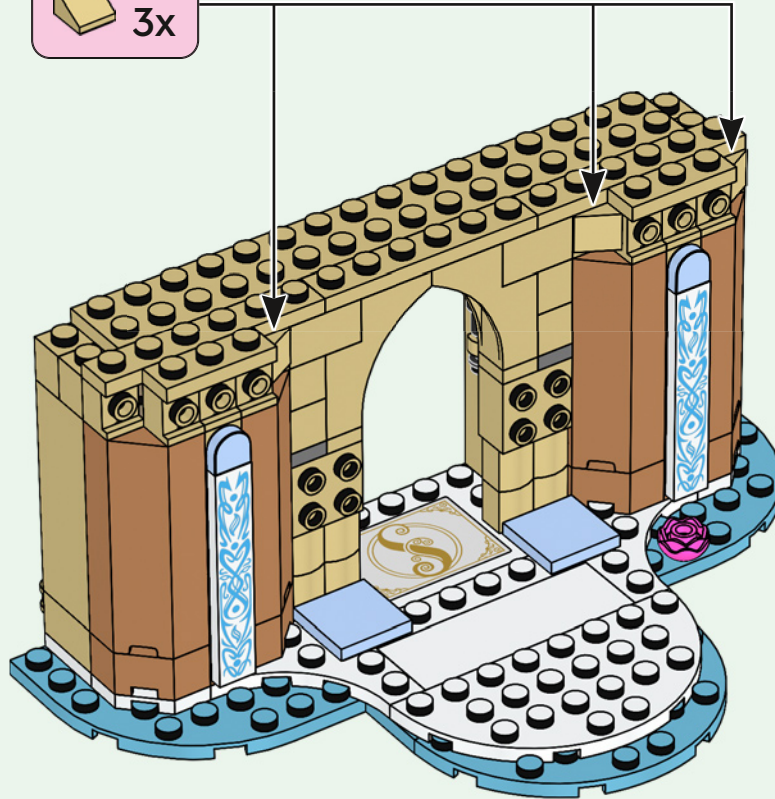

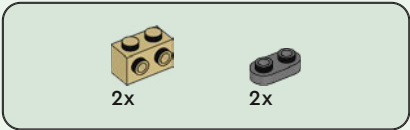

47

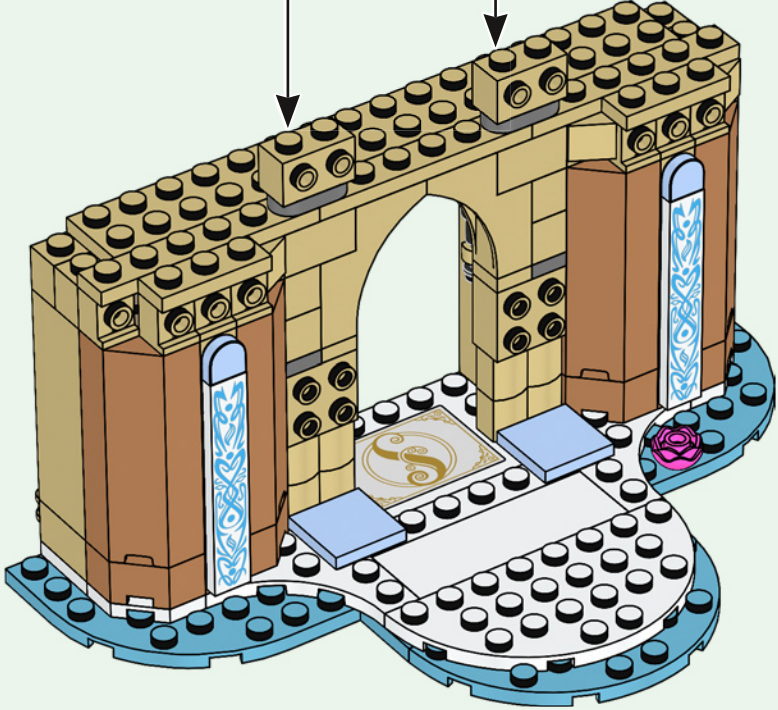
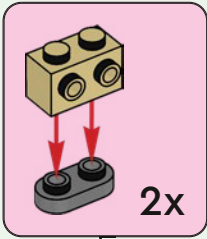



2x

48

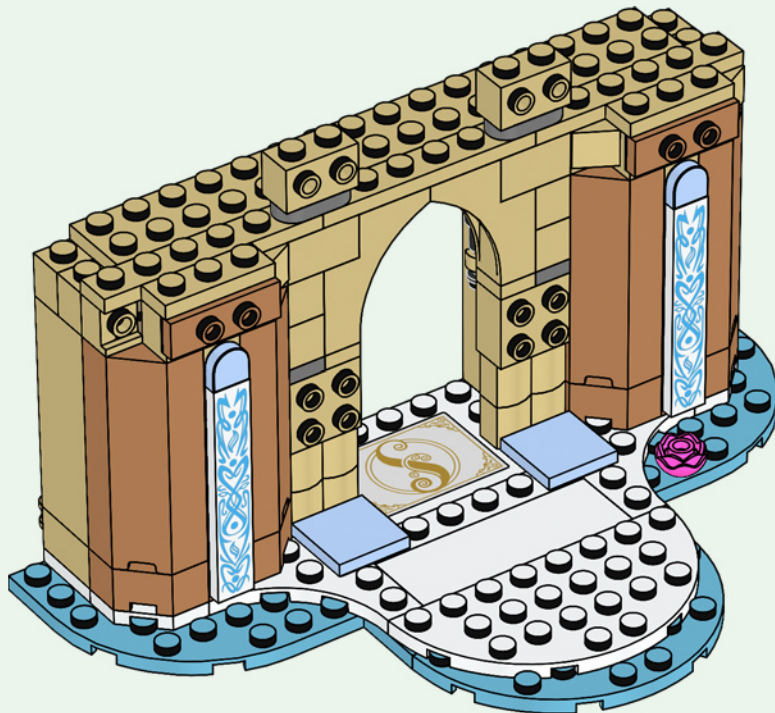

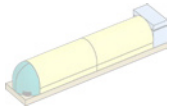

2x

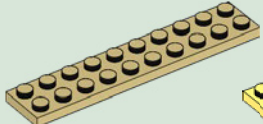

2x

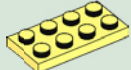

4x



2x



2x

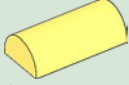

4x



4x

49

1

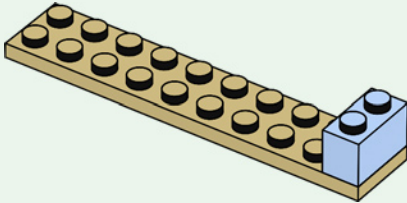

2

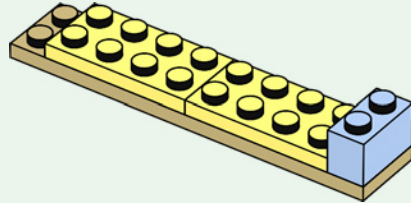



3

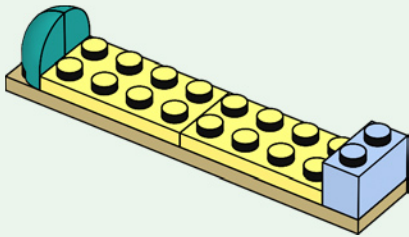

4

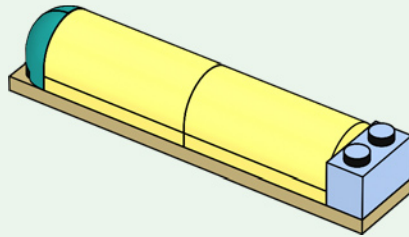

5

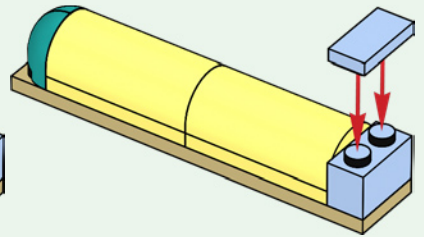

2x



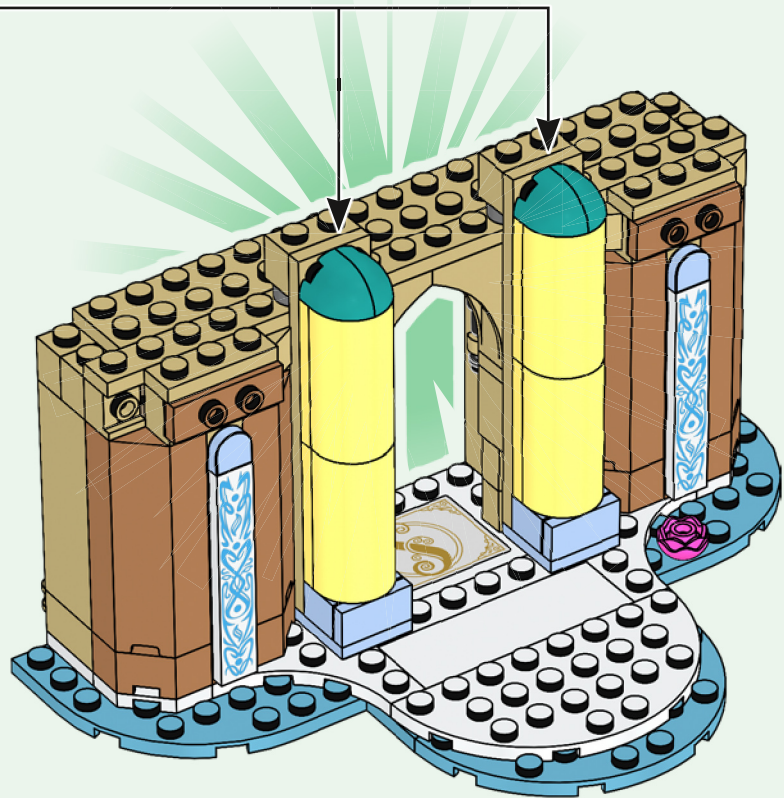

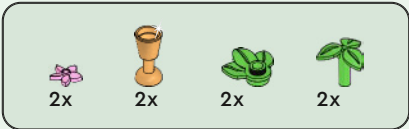

50

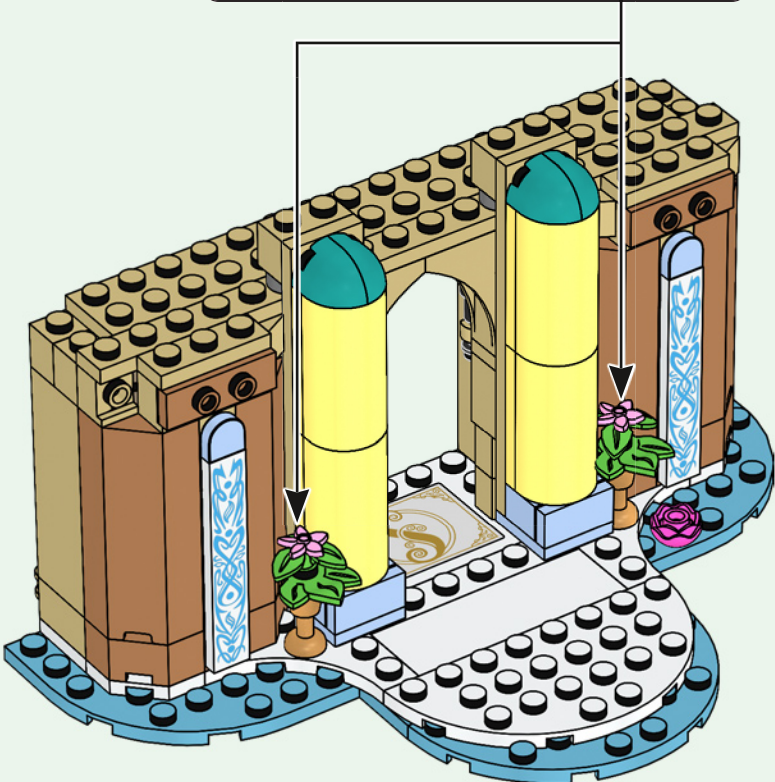
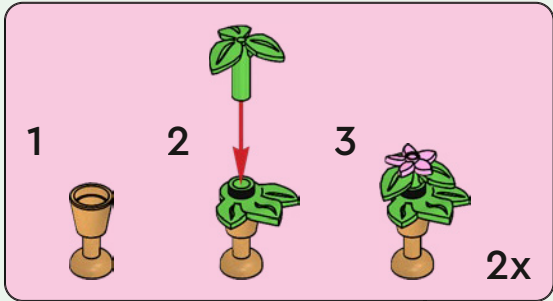



1x



3x

51

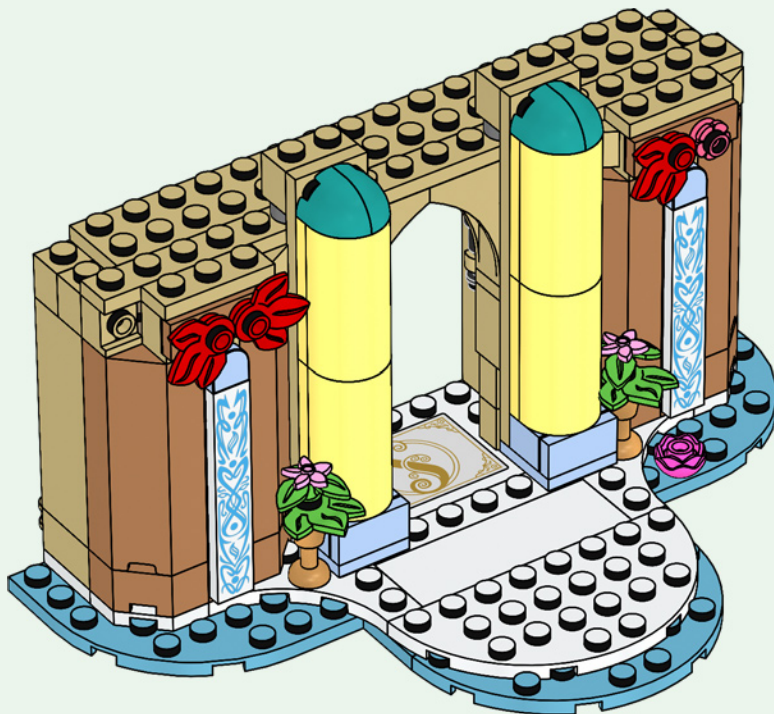



# 52

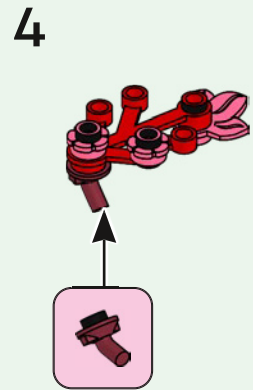
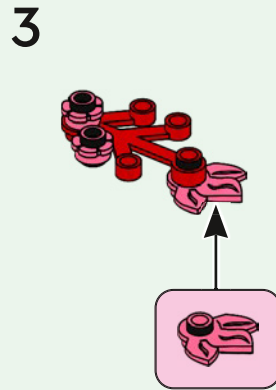
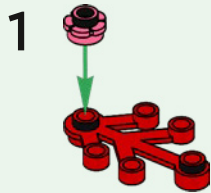



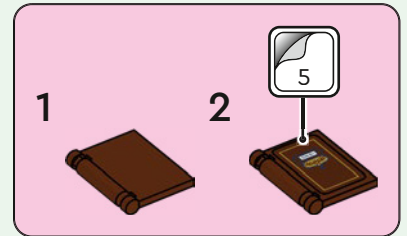
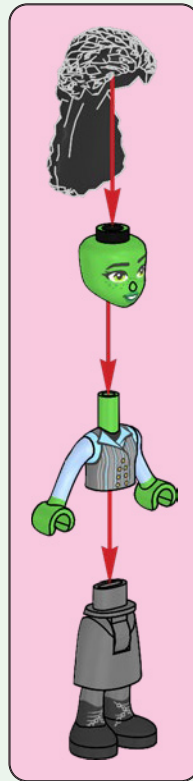



2x

53

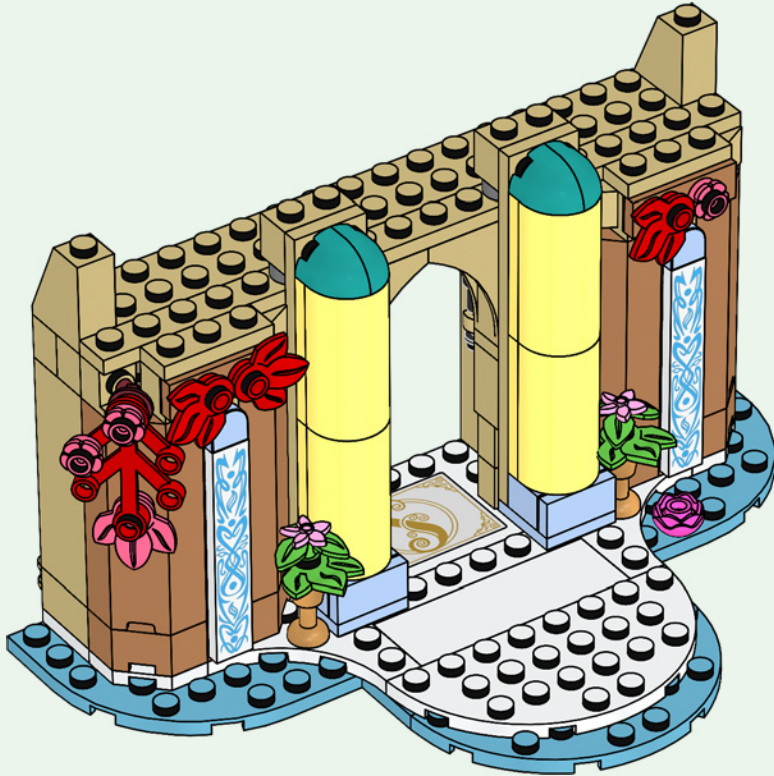



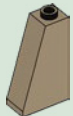

2x

54

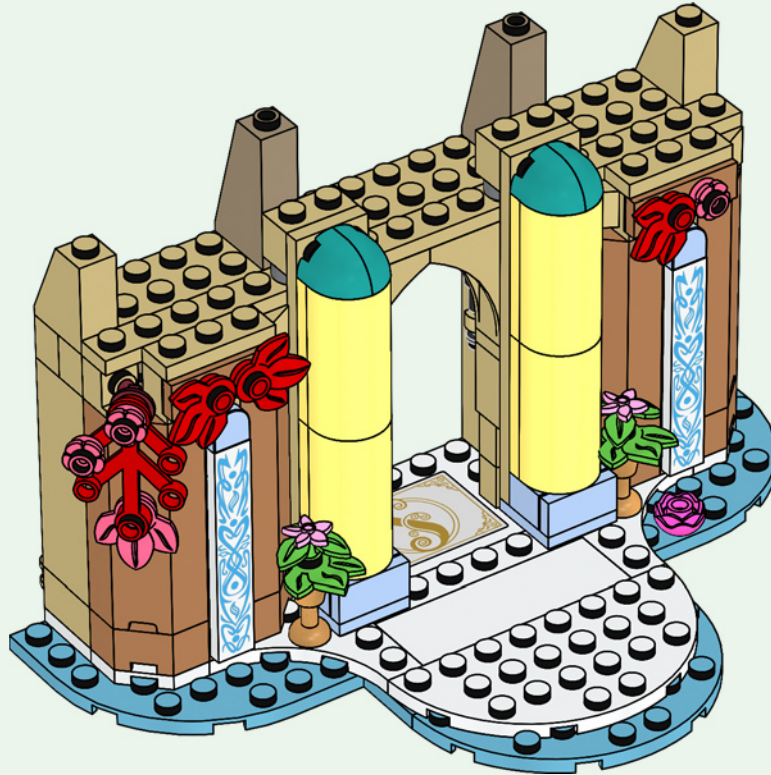



55

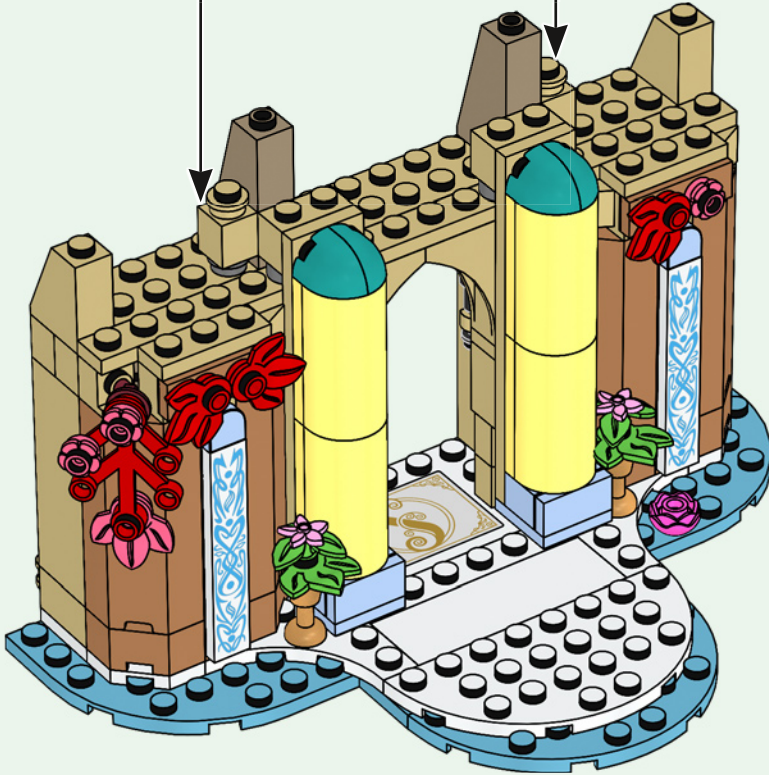
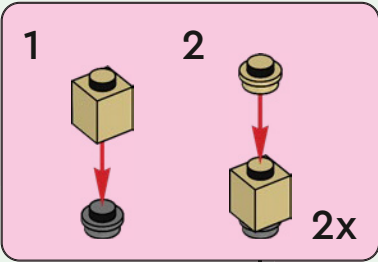



10x

56

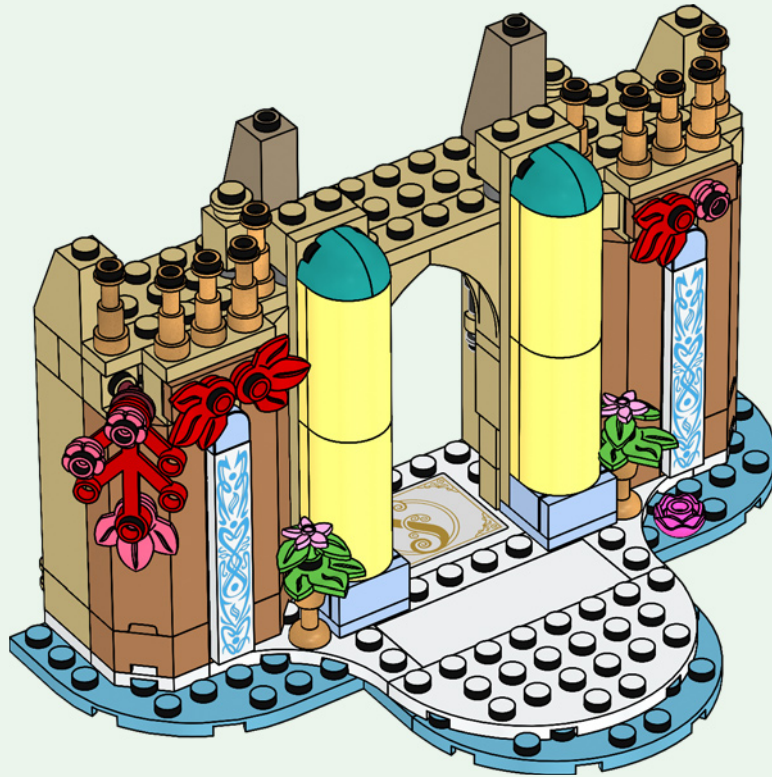



4x



2x

57

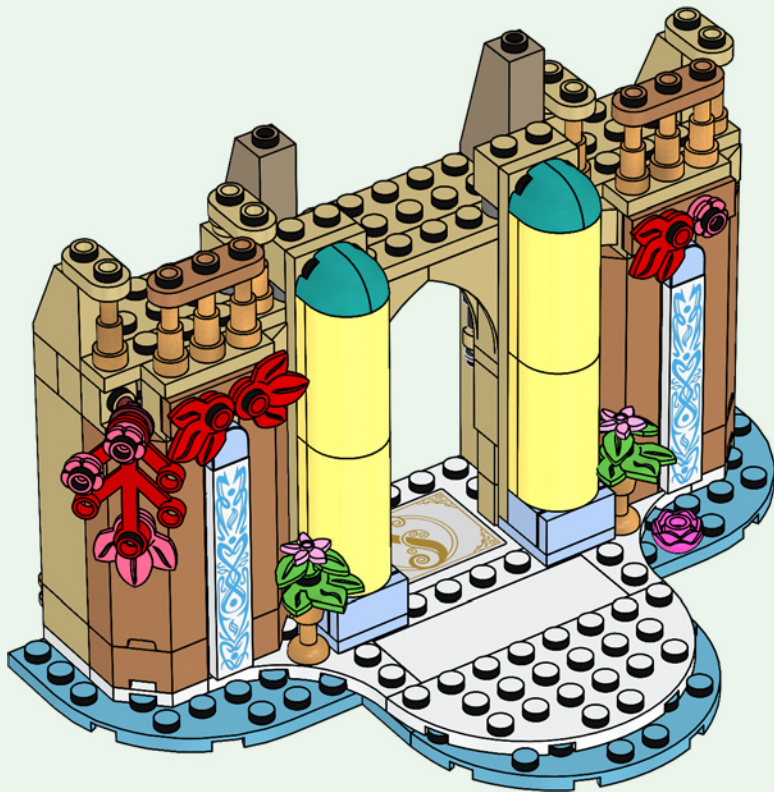

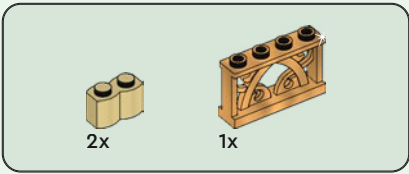

58

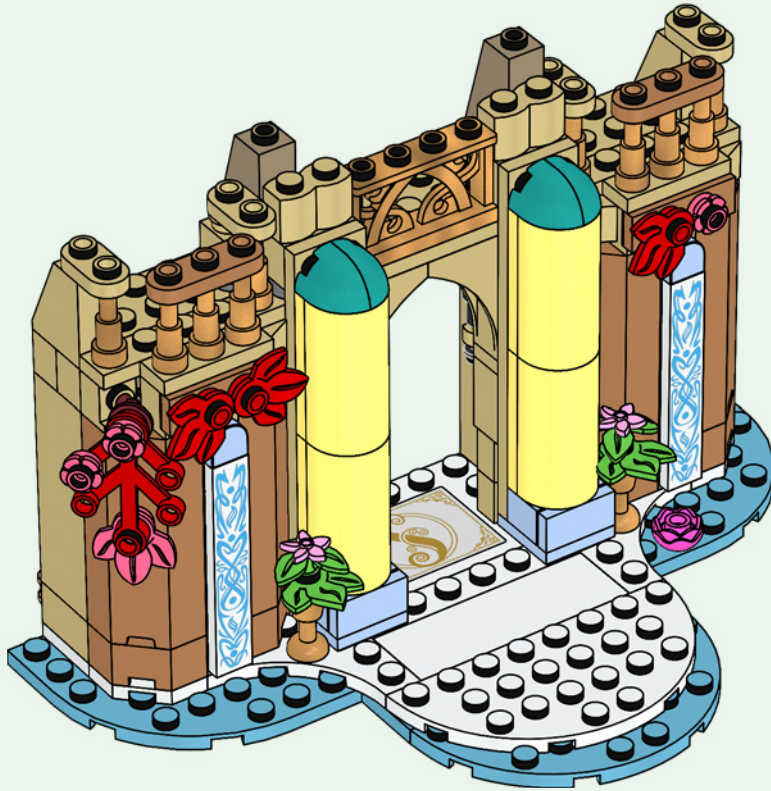



2x



4x

59

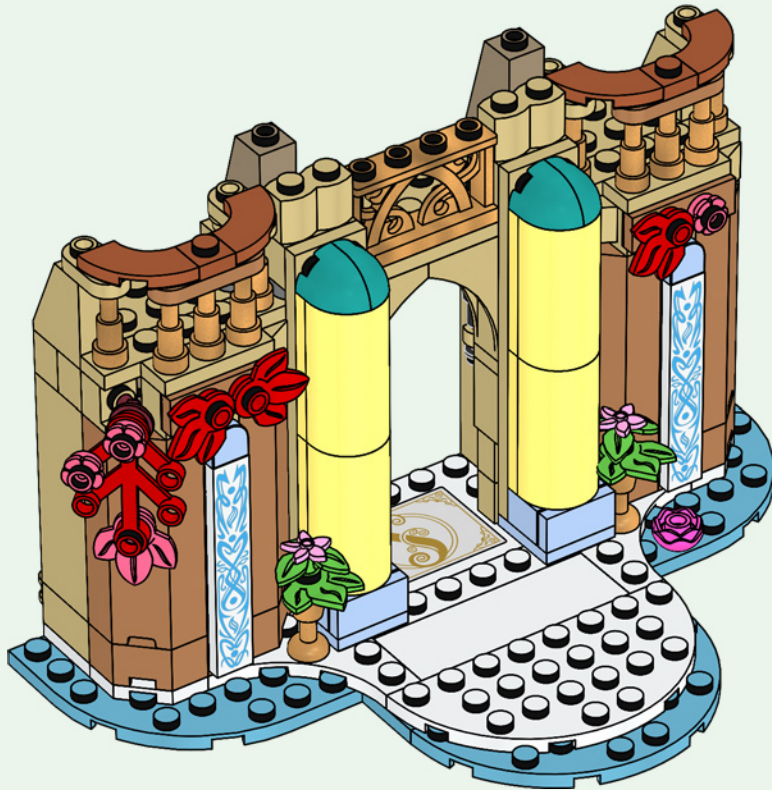



2x



2x

60

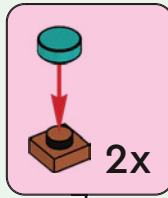



8x

61

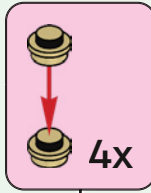

4x

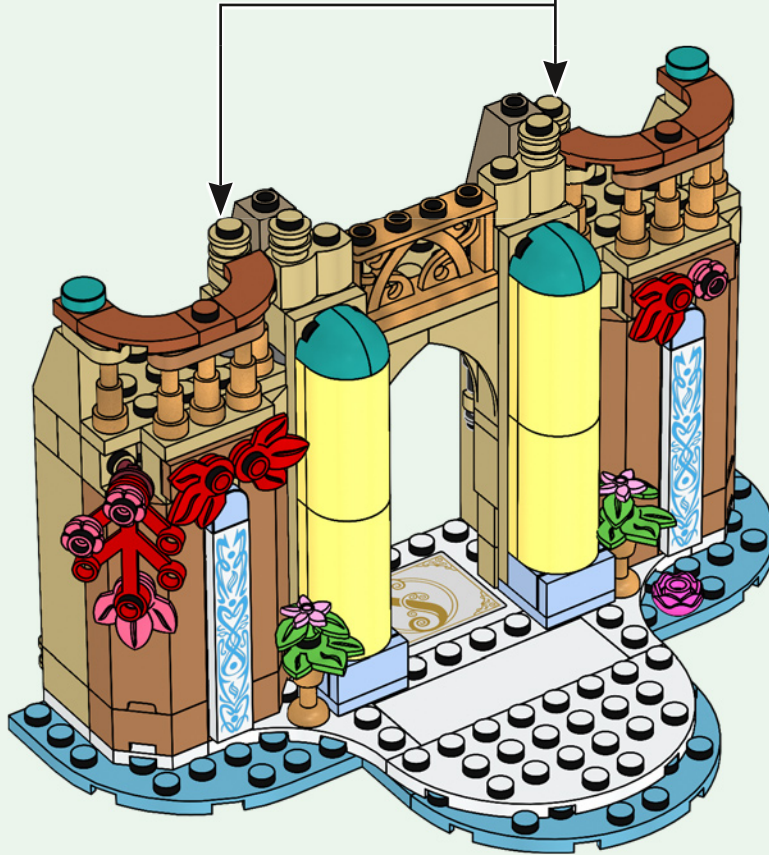





2x

62

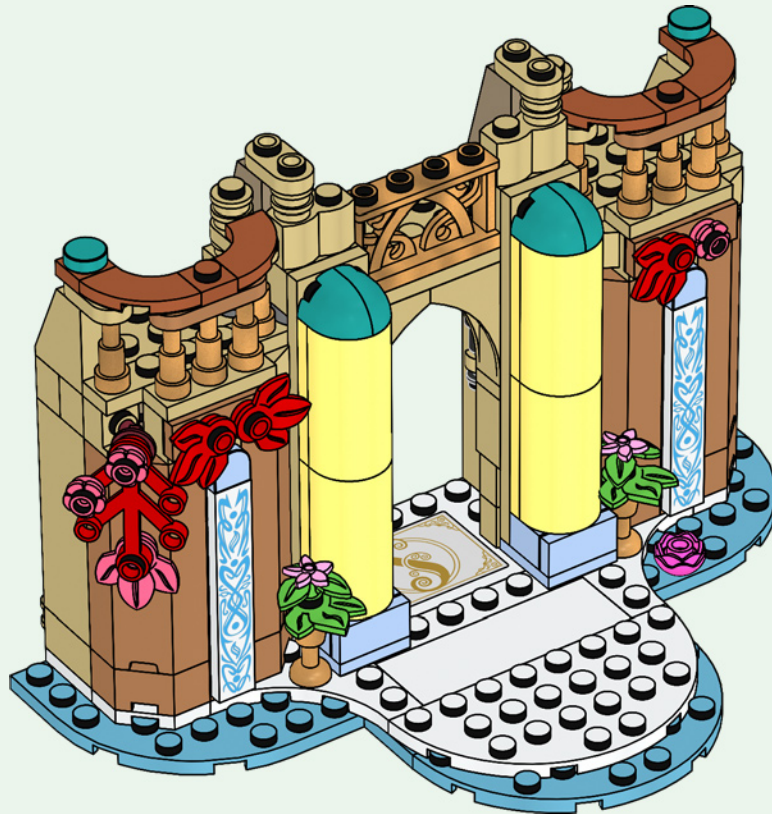



2x



2x

63





2x

64

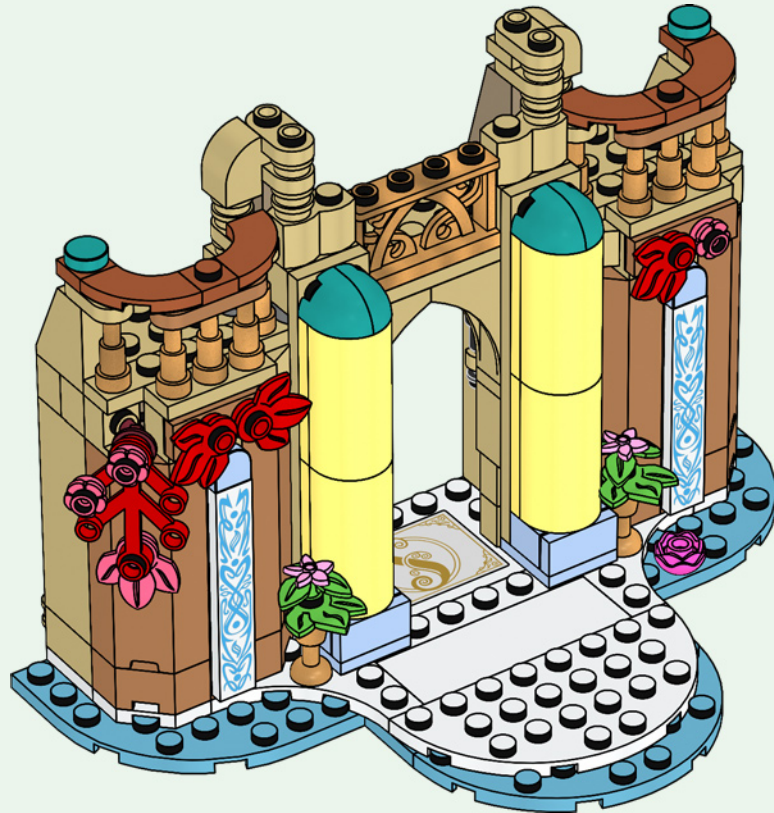



2x

65

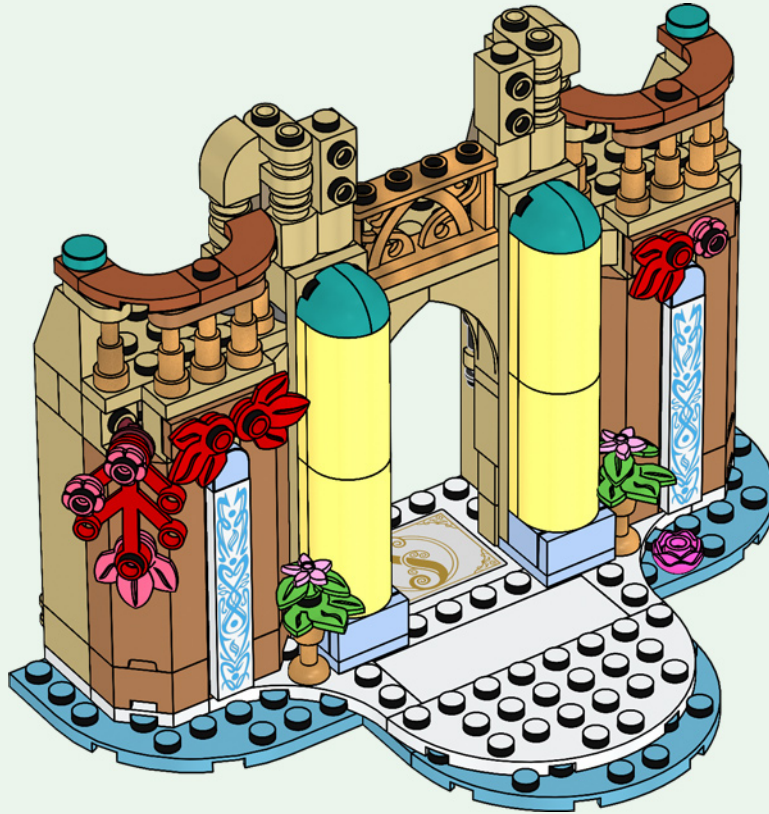

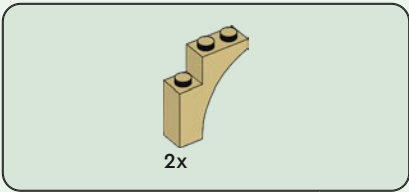

66





4x

67

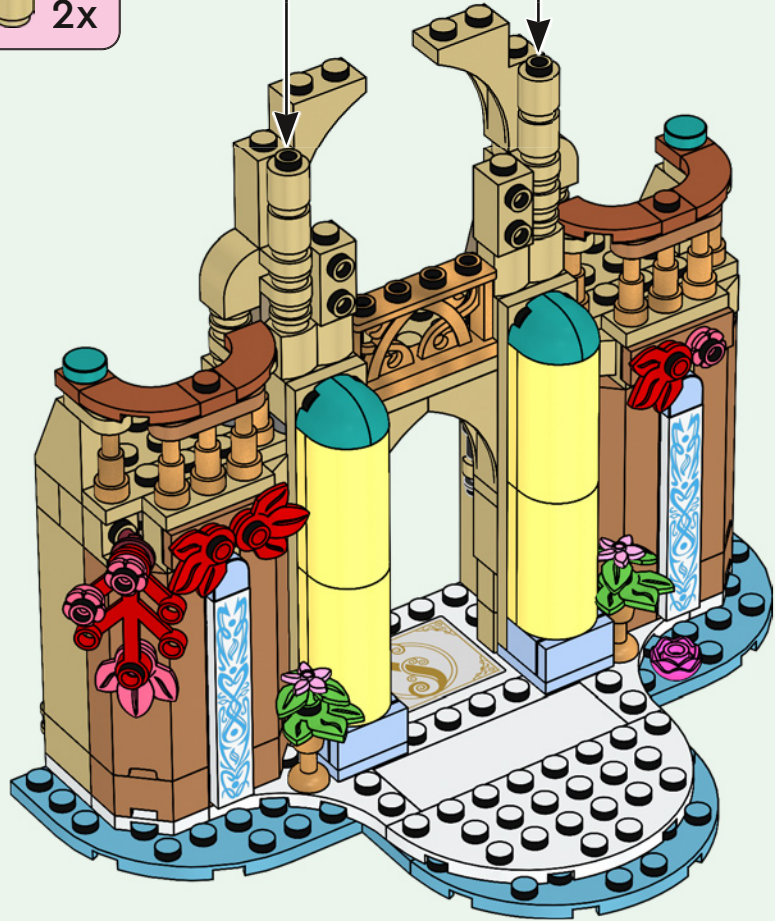
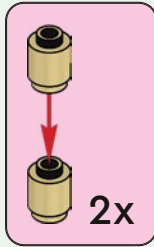

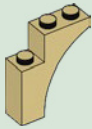

2x

68

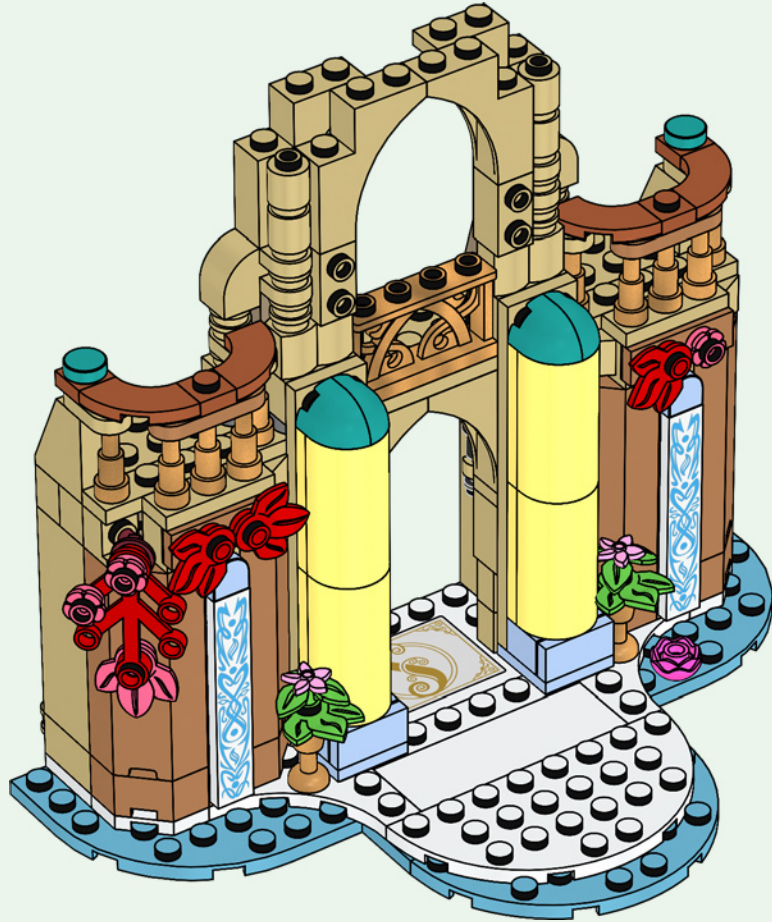



2x

69







2x

70

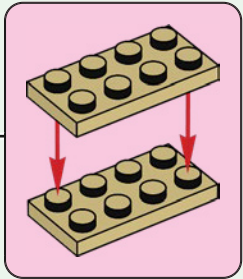



2x



2x

71

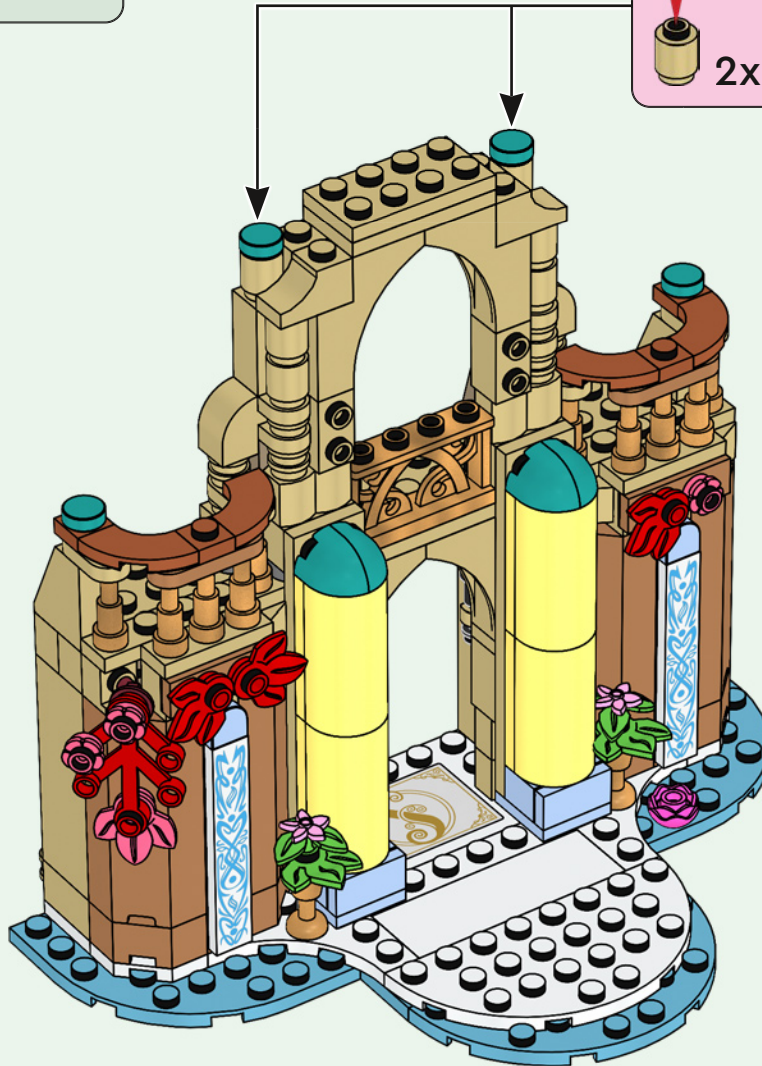
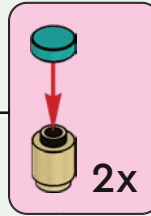



1x



2x

72





2x



2x

73

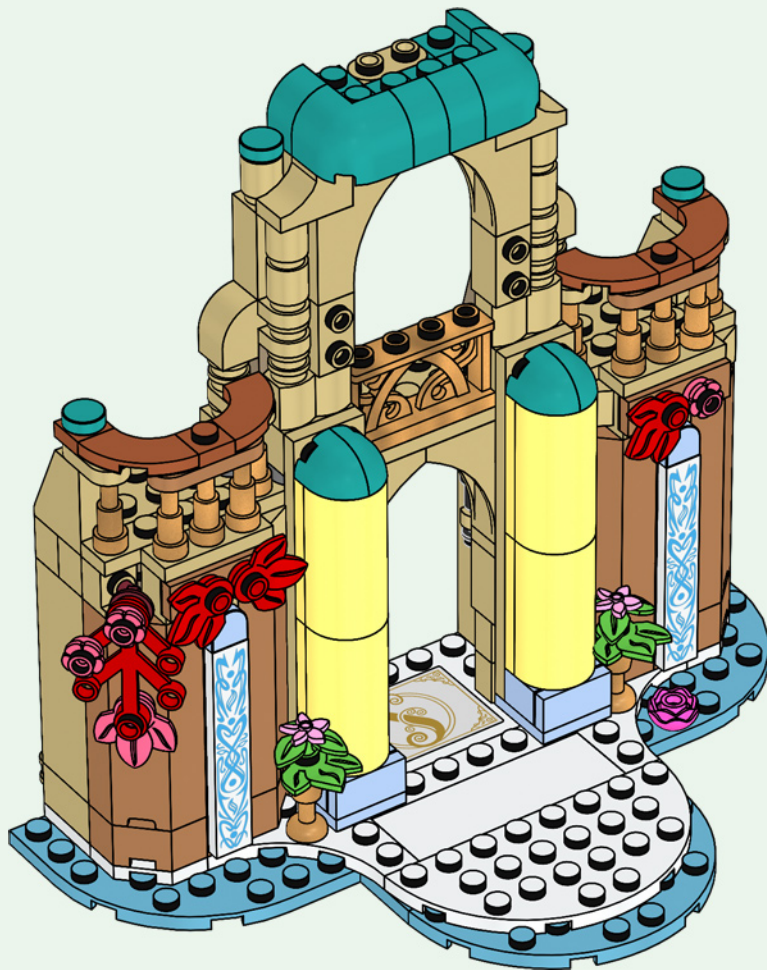

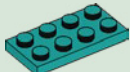

1x

74

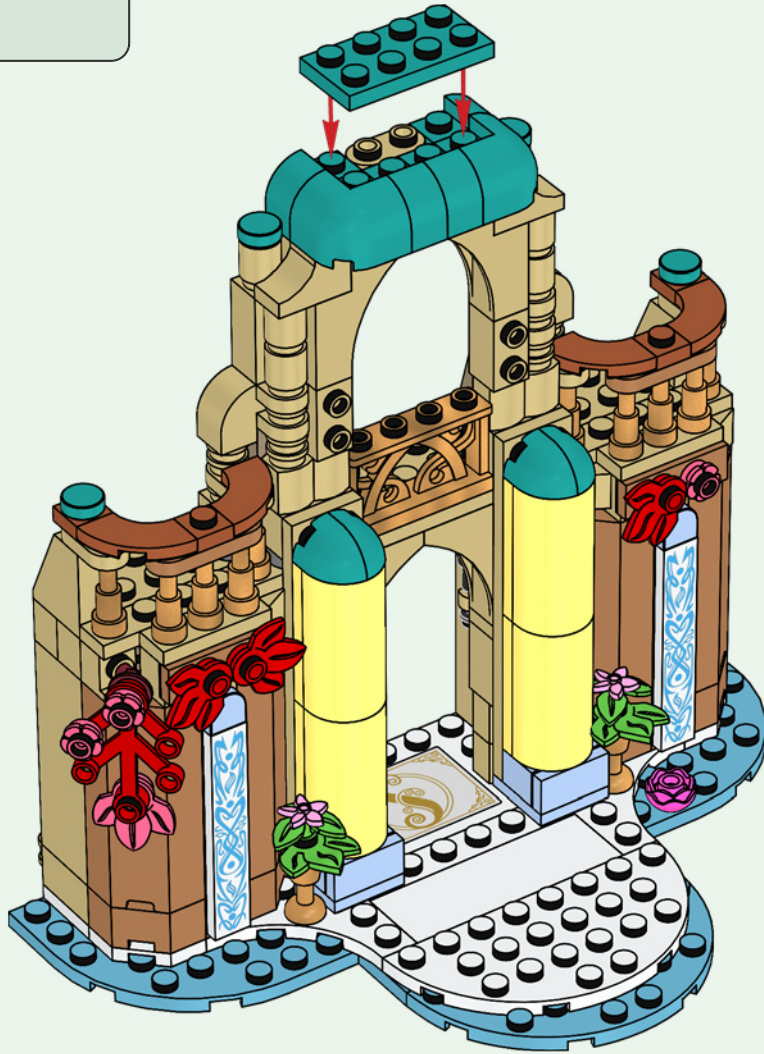

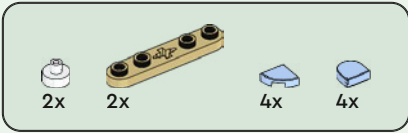

75

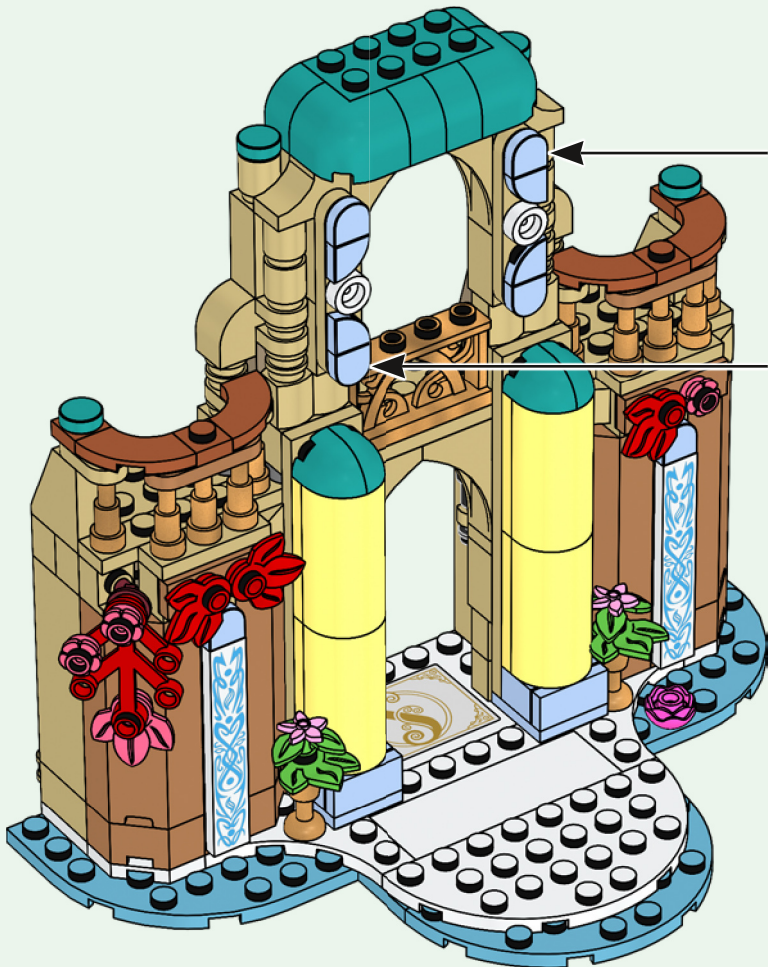
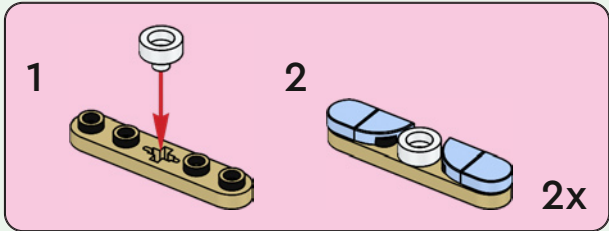





# WICKED

75681



75683



75684



75682







1x  
306901

4x  
302301

1x  
6126046

3x  
302101

1x  
366601

2x  
6510452

1x  
6332042

1x  
4163986

2x  
6186681

2x  
6176240

2x  
6254335

1x  
6138699

2x  
6357680

2x  
6116602

1x  
6518025

1x  
6518130

2x  
6332573

2x  
6375684

2x  
6271349

2x  
6515510

2x  
4112980

6x  
4218749

2x  
4114064

6x  
4113915

2x  
4124455

10x  
4118793

8x  
6232135

2x  
6214334

2x  
6024495

2x  
6226564

6x  
4117070

3x  
4516055

2x  
4626200

2x  
6383295

2x  
6411329

6x  
6058093

2x  
6352222

12x  
4161734

9x  
6212758

1x  
6512662

2x  
4618651

2x  
4121921

2x  
6311104

2x  
4618876

2x  
4114309

3x  
4124067

2x  
4249019

1x  
6030980

1x  
6172658

3x  
6372723

1x  
6512663

1x  
6527286

2x  
4538456

1x  
249626

2x  
6279875

2x  
6503251

2x  
6235080

2x  
6182261

1x  
6510386

4x  
6186012

4x  
6340042

1x  
6512372

1x  
6223655

1x  
6247798

1x  
6514027

1x  
6247792

4x  
6519763

4x  
6399564

2x  
6393823

1x  
6338181

4x  
6311437

1x  
6518095

2x  
4653509

3x  
6035540

1x  
6510194

2x  
6514274

1x 4211180  
1x 6174229  
1x 6268857  
4x 4211564  
1x 4211414  
1x 6284071  
2x 6146223  
1x 4211469  
1x 4211881  
2x 4210719  
2x 4210633  
2x 6221607  
1x 6517952  
6x 6364352

2x 6097861  
2x 6100322  
2x 6162894  
6x 6372233  
4x 6316571  
2x 6510453  
1x 6134285  
1x 6513737  
1x 4550359  
1x 6381793  
1x 6498748  
2x 6517936  
2x 6096990  
1x 6519761

1x 6510390  
1x 6097234  
2x 4505990  
10x 4538126  
1x 6510628  
1x 6514024  
1x 6247800  
2x 6057986  
4x 6469952  
2x 6292145  
2x 6492538  
4x 6499103

1x 6500671  
1x 6518131  
1x 6510448  
1x 6070757  
2x 6253666  
1x 6138571  
2x 6133693  
4x 6301838  
4x 6296524

1x 6223598  
1x 6518152  
1x 6023826  
3x 6295242  
1x 6375789

1x 6519762



 [LEGO.com/service](https://LEGO.com/service)

YOU COULD **WIN**



Scan this QR code or go to  
**LEGO.COM/PRODUCTFEEDBACK** and give us  
your short feedback about this LEGO® set for a  
chance to win a cool LEGO prize.

Terms and Conditions apply\*

**EN: YOU COULD WIN.** Terms and Conditions apply\* **DE: Du könntest GEWINNEN.** Es gelten die Teilnahmebedingungen\* **FR: Tu pourrais GAGNER.** Des conditions s'appliquent\* **IT: Potresti VINCERE tu.** Termini e condizioni sono applicabili\* **ES: Puedes GANAR.** Aplican términos y condiciones\* **PT: Poderá GANHAR.** Aplicam-se termos e condições\* **ZH: 轻松获奖. 条款和条件适用\*** **PL: Szansa na WYGRANĄ.** Obowiązują warunki korzystania\* **CS: Máte šanci VYHRÁT.** Platí všeobecné smluvní podmínky\* **SK: Máte šancu VYHRAŤ.** Platia všeobecné zmluvné podmienky\* **HU: TE IS NYERHETSZ.** Felhasználási feltételek érvényesek\* **RO: Ai putea CÂȘTIGA.** Se aplică termeni și condiții\* **BG: Можете да СПЕЧЕЛИТЕ.** Има определени правила и условия\* **LV: Tu vari LAIMĒT.** Ir spēkā noteikumi un nosacījumi.\* **ET: Sul on võimalus VÕITA.** Kehtivad tingimused\* **LT: Jūs galite LAIMĖTI.** Taikomos sąlygos\*

\*[LEGO.com/productfeedback-terms](https://www.lego.com/productfeedback-terms)

LEGO and the LEGO logo are trademarks of the LEGO Group. ©2024 The LEGO Group.

© Universal City Studios LLC. All Rights Reserved.