

4000 Series

UK User Manual



Here at Ebac, we love hearing
what our customers think
of our products!

How did we do? Review us

on  Trustpilot

You can leave a review at
www.trustpilot.com/review/www.ebac.com



CONTENTS

Introduction.....	4
Unpacking your dehumidifier.....	4
Technical and safety information.....	5
Warnings for using R290 refrigerant only.....	6
Setting up your dehumidifier.....	7
SMART Control™.....	7
4000 series parts.....	8
Settings & controls.....	9
Cleaning the filter.....	11
App control	12
Emptying the water container.....	15
Troubleshooting.....	16
Warranty information.....	19

Introduction

At Ebac we pride ourselves on being the dehumidifier experts. With over 50 years experience we have helped over 1 million customers remove excess moisture from their homes. Our range of products (all designed and manufactured in the UK) reflects our years of expertise and provides an option for every home.

The first time you plug in your new Ebac dehumidifier you'll begin to realise the difference it will make to your home. You'll be amazed at just how much water this quiet, yet powerful unit extracts and stores in its container. It's sure to get you thinking where it all comes from and where it's been going all those years.

Incredibly, the average family produces 20 pints/12 litres of moisture a day. However, that's one fact you needn't worry about now. Your Ebac dehumidifier is designed to cope with everything you do that adds even more moisture to the British climate. Everything from showering to washing up, boiling a kettle to breathing; they all add moisture to the air.

This manual will help you get the very best out of your Ebac and not only protect your home from the damaging effects of condensation and damp, but also improve the quality of your air.

During installation and maintenance, respect the precautions indicated in the manual, and on the labels applied inside the units.

Unpacking your dehumidifier

Please ensure that all packaging is disposed of or stored safely where it will not be a danger to children or pets.

In the unlikely event of having to return your dehumidifier for repair, cardboard packaging will be required. You may wish to consider this before disposing of the packaging.

Stand your dehumidifier upright for a minimum of 2 hours before switching on.

Technical & safety information

Min Operating Temperature 3°C

Max Operating Temperature 35°C

Fuse Rating 13A

- Do not use the machine if the power cord or cabinet are damaged.
- If the machine is damaged or in need of repair please contact Ebac.
- Do not poke objects into any grilles on the machine.
- This machine complies with EMC/RFI directive EN60555 (BS800).
- Ebac has a policy of constant development and, therefore, reserves the right to change specifications without prior notice.
- Do not use the machine without the permanent drainage bung in place on the back of the machine.
- Your dehumidifier should not be located in such a way that it will become an obstacle or hazard.
- Your dehumidifier should not be placed directly at the top of the stairs.
- To protect against electrical shocks, do not immerse unit, plug or cord in water, or spray with liquids.
- Ebac would always recommend plugging the appliance directly into the mains where possible however an extension lead may be used if required. The extension lead should be rated at the correct current for the appliance, fuse protected and electrically safe. The extension must not be overloaded. It is the responsibility of the user to ensure all of these conditions are met. Ebac won't accept responsibility for malfunction due to the use of an extension.
- Ensure Power supply is RCD protected at 30mA.
- Do not put the unit close to heat-generating devices or near flammable and dangerous materials. (e.g. electrical fires, fireplaces, etc.)

Please note: This appliance can be used by children aged from 8 years and above and persons with reduced physical, sensory or mental capabilities or lack of experience and knowledge if they have supervision or have been given instruction concerning the use of the appliance in a safe way, and understand the hazards involved. Children should not play with the appliance. Cleaning and user maintenance shall not be made by children without supervision.

WARNING! THIS PRODUCT CONTAINS R290 FLAMMABLE REFRIGERANT GAS. READ THE SPECIFIC WARNINGS GIVEN IN THIS MANUAL.

Warnings for using R290 refrigerant only

- The appliance contains R290 gas (A3 flammability classification).
- Do not use any means to accelerate the defrosting process.
- When cleaning the appliance this should be limited to the exterior panels and filter, following the guidelines within this manual. If the appliance is installed, used or stored in an unventilated room, the room must be such as to prevent stagnation of possible leaks of refrigerant gas as there could be a danger of fire or explosion should the refrigerant come into contact with electric heaters, stoves or other sources of ignition.
- The appliance shall be stored in a well-ventilated area where the room size corresponds to the room area as specified for operation. (4m² - this equates to a 2 meter by 2 meter room)
- The appliance shall be stored in a room without continuously operating ignition sources (for example: open flames, an operating gas appliance or an operating electric heater).
- Do not pierce or burn.
- Be aware that the refrigerants may not contain an odour.
- Appliance should be installed, operated and stored in a room with a floor area larger than 4m² (this equates to a 2 meter by 2 meter room).
- This appliance contains ≤90g of R290 refrigerant gas
- R290 is a refrigerant gas that complies with the European directives on the environment. Do not puncture any part of the refrigerant circuit.
- Compliance with national gas regulations shall be observed.
- Keep ventilation openings clear of obstruction.
- The appliance shall be stored so as to prevent mechanical damage from occurring.
- The appliance must be returned to the manufacturer Ebac for service or repair.
- This dehumidifier must not be used in spaces where there is a high concentration of gases, solvent or other volatile organic compounds; in very dusty environments; in any domestic, commercial or industrial environment where the air composition is flammable.



CAUTION





Risk of fire/flammable materials (Required for R290 units only)



IMPORTANT NOTICE

Read this manual carefully before installing or operating your new dehumidifier unit. Make sure to save this manual for future reference.

EXPLANATION OF SYMBOLS DISPLAYED ON THE UNIT

	WARNING	This symbol shows that this appliance uses a flammable refrigerant. If the refrigerant is leaked and exposed to an external ignition source, there is a risk of fire.
	CAUTION	This symbol shows that the operation manual should be read carefully.
	CAUTION	This symbol shows that service personnel should be handling this equipment with reference to the installation manual.
	CAUTION	This symbol shows that information is available such as the operating manual or installation manual.

Setting up your dehumidifier for maximum performance

LOCATION

Unless you have a particular area in need, we suggest that you place your dehumidifier in the coldest, dampest part of the home or alternatively in a central location ensuring that safety is paramount.

Since moisture rises, first floor location is preferable.

Place the dehumidifier away from direct heat source. As the unit uses a cold surface to collect moisture, direct heat will reduce its ability to do so. Doors should be kept ajar to ensure good air flow throughout the home.

Your dehumidifier will not operate should the temperature drop below 3^oc.

OPERATION

Unless you have a severe problem with excess moisture or damp, we recommend plugging in the dehumidifier and running on SMART Control. Your dehumidifier should run on this setting continuously for 6 hours when switching on for the first time.

It will then switch on and off automatically at the most economical times to keep the humidity at the correct level.

In the event of needing to increase air flow and water collection, the dehumidifier can be run on BOOST for a set period of time.

COMFORT

The compressor will make a humming noise similar to that of your fridge freezer. We recommend that the dehumidifier is not placed directly onto a hard floor as this will increase and amplify the sound.

To ensure that your sleep pattern is not disturbed, the dehumidifier is best suited to be located away from your bedroom door.

Smart Control

Set your Ebac 4000 series to Smart Control and let it do all the hard work. Ebac's patented SmartControl™ technology continuously monitors and learns about environmental factors in and around your home so that it knows when it needs to work and when it doesn't. This reduces running time and ensures lower running costs.

Throughout this manual Smart Control™ will be referred to as SMART Mode.

4000 Series parts

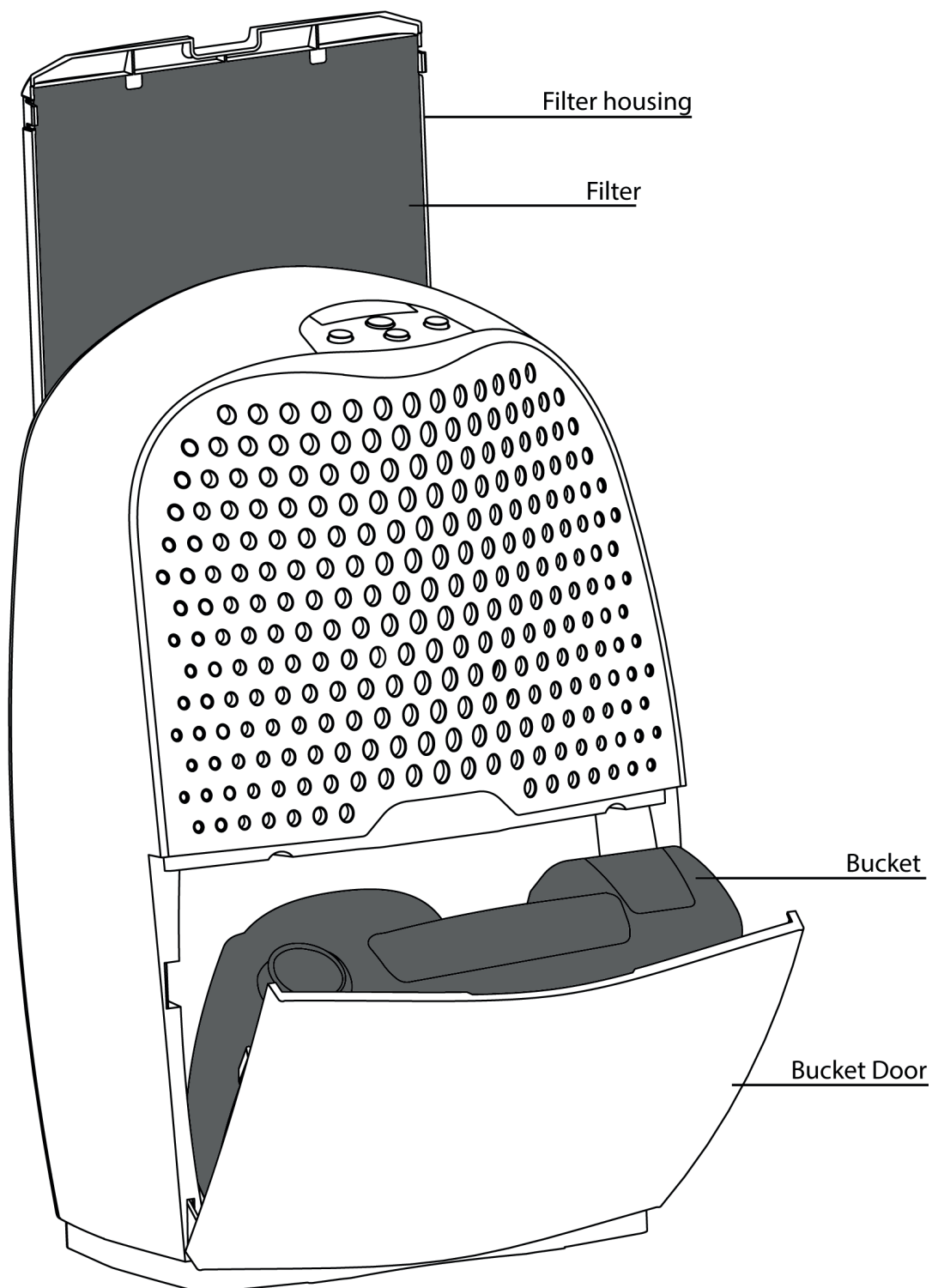

Settings & controls

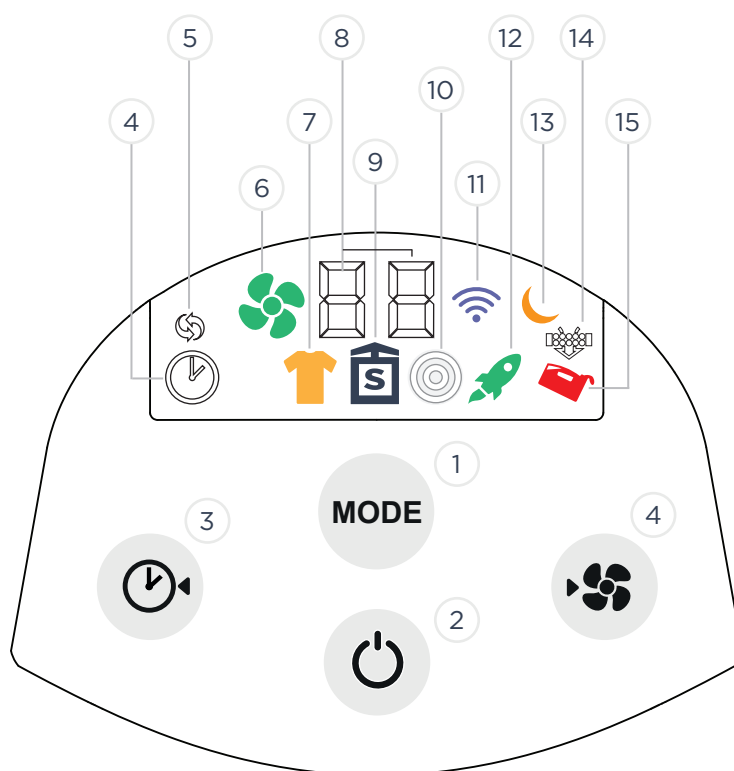

Please refer to the image above when numbers are indicated within the instructions

SWITCHING ON YOUR DEHUMIDIFIER

Stand your dehumidifier upright for a minimum of 2 hours before switching on.

Remove the bucket and plug the unit in



Note that the red bucket icon (15) is illuminated to indicate that the water bucket is not present. Note the same icon will also illuminate to indicate that the bucket is full.

Place the bucket in the unit and close the door



The SMART icon (9) will now be illuminated blue; the unit is now operating and running in SMART mode.

We recommend that you use this setting permanently unless you have a problem with damp or would like to dry laundry (see 'Using the Laundry Drying Mode' section).

The digital display (8) is also illuminated to show the relative humidity.

Settings & controls cont.

SELECTING DIFFERENT MODES

Press the **MODE** button (1) to cycle through the available modes



Although we recommend using SMART mode to regulate the humidity other options available include LAUNDRY mode (7) TARGET mode (10) and BOOST (12).

USING THE LAUNDRY MODE

Press the **MODE** button (1) to cycle to LAUNDRY mode and the laundry symbol (7) will illuminate



The unit is now set to operate at the highest fan speed and at optimal capacity for clothes drying It automatically changes to SMART mode after 8 hours operation.



USING THE TARGET MODE

Press the **MODE** button (1) to cycle to TARGET mode and the TARGET symbol (10) will illuminate and the digital display will flash.

Use the left and right buttons (3)(4) to adjust the target humidity.



Target mode should only be used to maintain a specific humidity, Smart mode should be in all other instances.

The unit is now in TARGET mode. The dehumidifier will operate until the target humidity is reached.

When the target humidity has been set for 3 seconds the display will revert to displaying the current humidity. To display the target humidity in target mode press the mode button (1). To leave target mode press MODE button (1) twice.



USING BOOST MODE

Press the **MODE** button (1) to cycle to BOOST mode



The unit is now set to continuously operate at the highest fan speed and at maximum capacity.

Settings & controls cont.

USING THE TIMER FUNCTION

Press and hold the **TIMER** button (3) to cycle through the options. Use  to scroll.

Select 0hrs option to operate continuously (without timer)



The timer function dictates how long the unit will operate.

The order the times will cycle through is as follows:

1hr - 2hrs - 3hrs - 4hrs - 5hrs - 6hrs - 7hrs - 8hrs - 0hrs

If modes are switched the timer will still operate unless reduced to 0hrs

SWITCHING UNIT TO STANDBY

Press the **POWER** button (2)



The STANDBY light (13) will now be illuminated orange; the unit is now in STANDBY mode.

CHANGING THE FAN SPEED

Press the **FAN** button (4) to cycle through the fan speeds



The fan symbol (6) will flash slowly or fast.

USING NIGHT MODE

NIGHT mode can only be activated by the app.

On activation of NIGHT mode the unit runs at reduced fan speed.

FILTER CHANGE

The filter change icon indicates that the filter is ready to be changed.



On changing the filter the 'fan' button needs to be pressed for 4 seconds to turn off/ reset the indicator.

App Control

Your 4000 series dehumidifier has the ability to be controlled over Wi-Fi from your smart phone or tablet. The app is available from the Itunes or Android play store by searching for 'Smart Life'.

APP REGISTRATION

- 1 Ensure your device is connected to the local 2.4 GHz Wi-Fi network. Turn off your mobile data and ensure your dehumidifier is in an area which receives good reception from your WIFI Router. Press the power button so that the dehumidifier is switched on and working.

- 2 If not yet registered click the Smart Life app and enter the login screen. If it is your first time, please click the "Sign Up" key. Please input your email address (compulsory to enable password recovery) accept the user agreement click the "Get Verification Code" key. The verification code will be sent to the email address registered and you will have 60 seconds to enter the verification code.

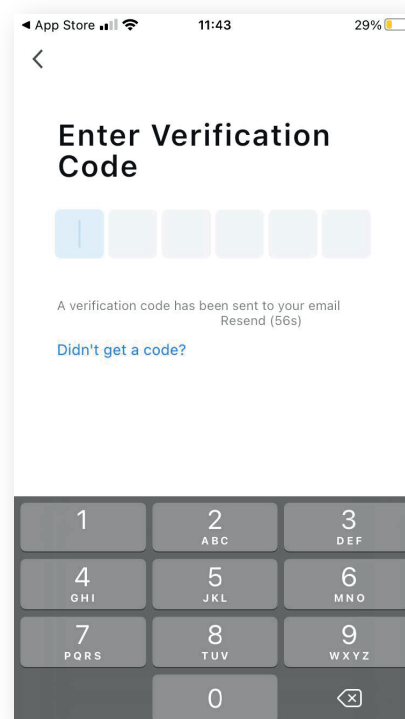
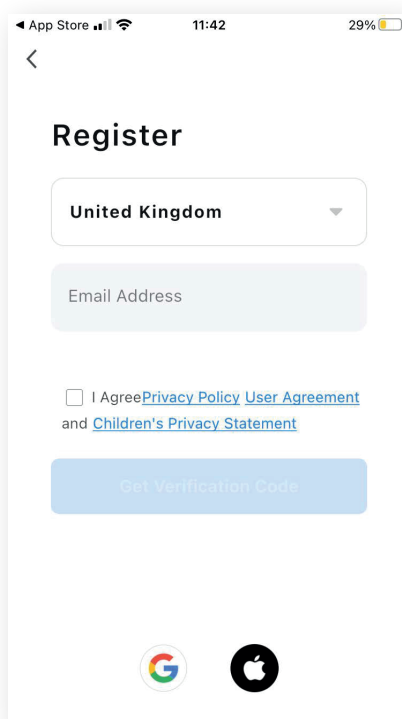
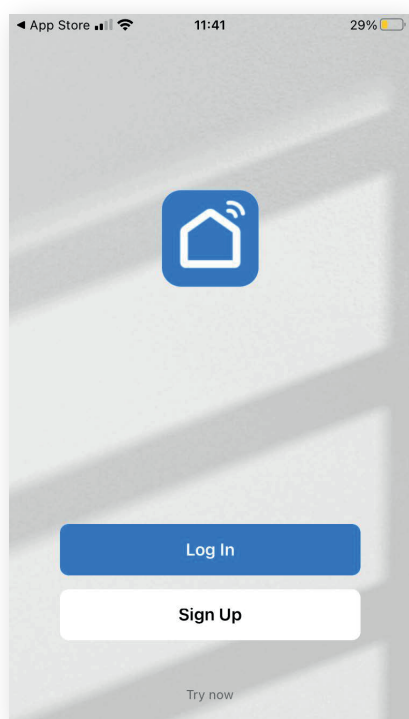

App Control

SETTING A PASSWORD

3 Set a password and select “Done”.

If you wish to benefit from the full functionality of the app accept the access permissions and allow the use of Bluetooth if prompted.

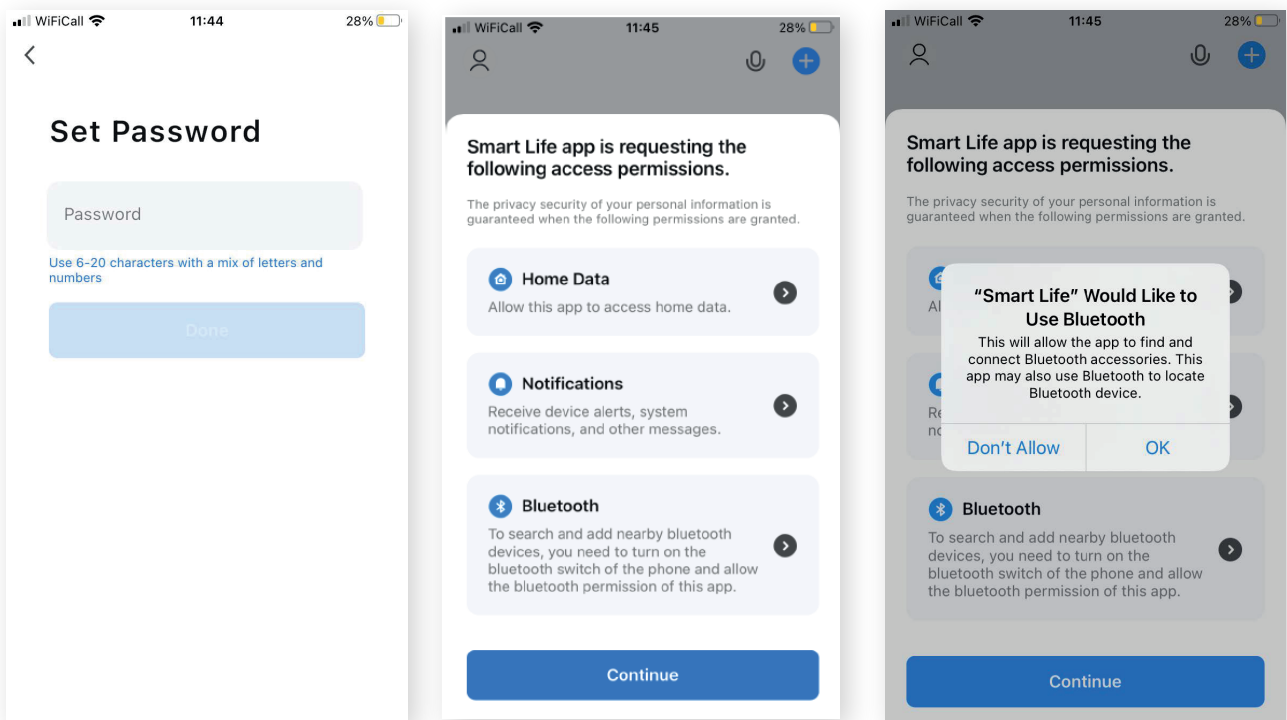

App Control

PAIRING YOUR DEVICE

- 4 You will now arrive at the Add Device screen. To put the Dehumidifier into pairing mode press the power button for 4 seconds. The blue Wi-Fi indicator will flash to indicate it is in pairing mode. On the app press “Add device”.

After a few seconds the Ebac 4000 dehumidifier should show up - click add.

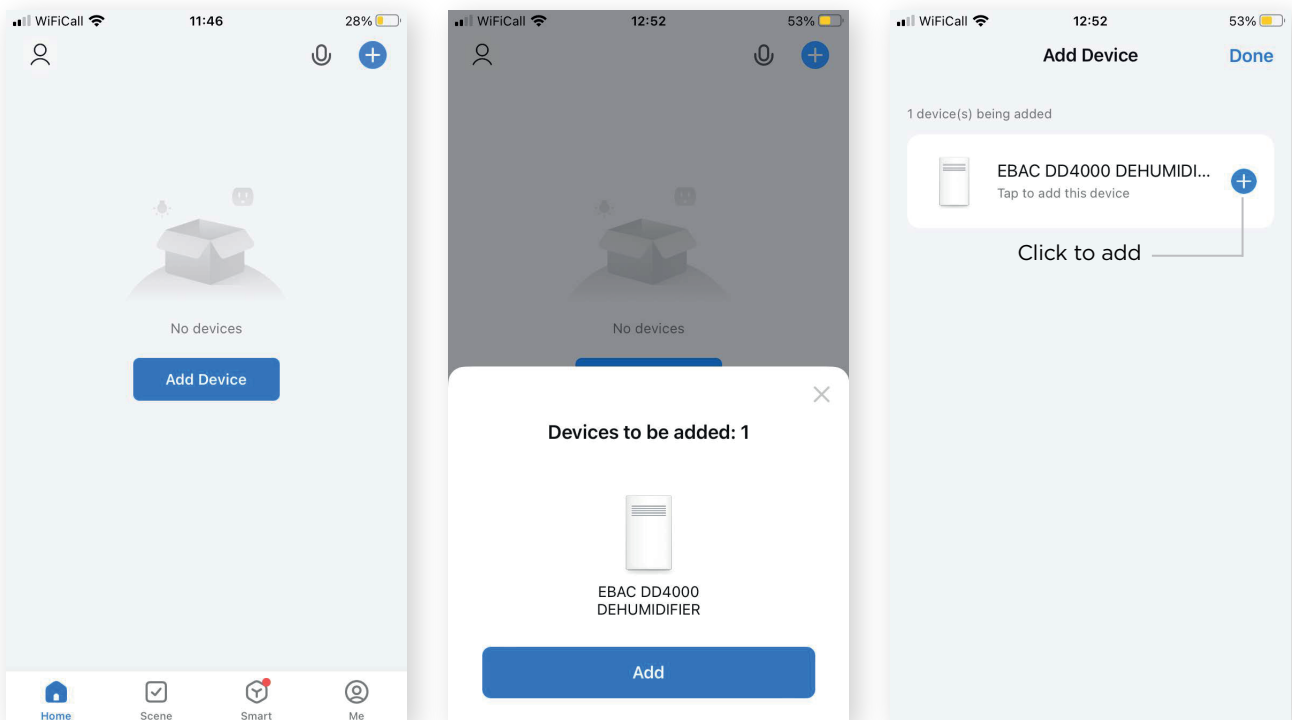

App Control

LOCATION SERVICES

- 5 Accept location services to get the Wi-Fi name automatically and if prompted allow location services whilst using the app.

Choose the local 2.4 GHz network and enter the password.

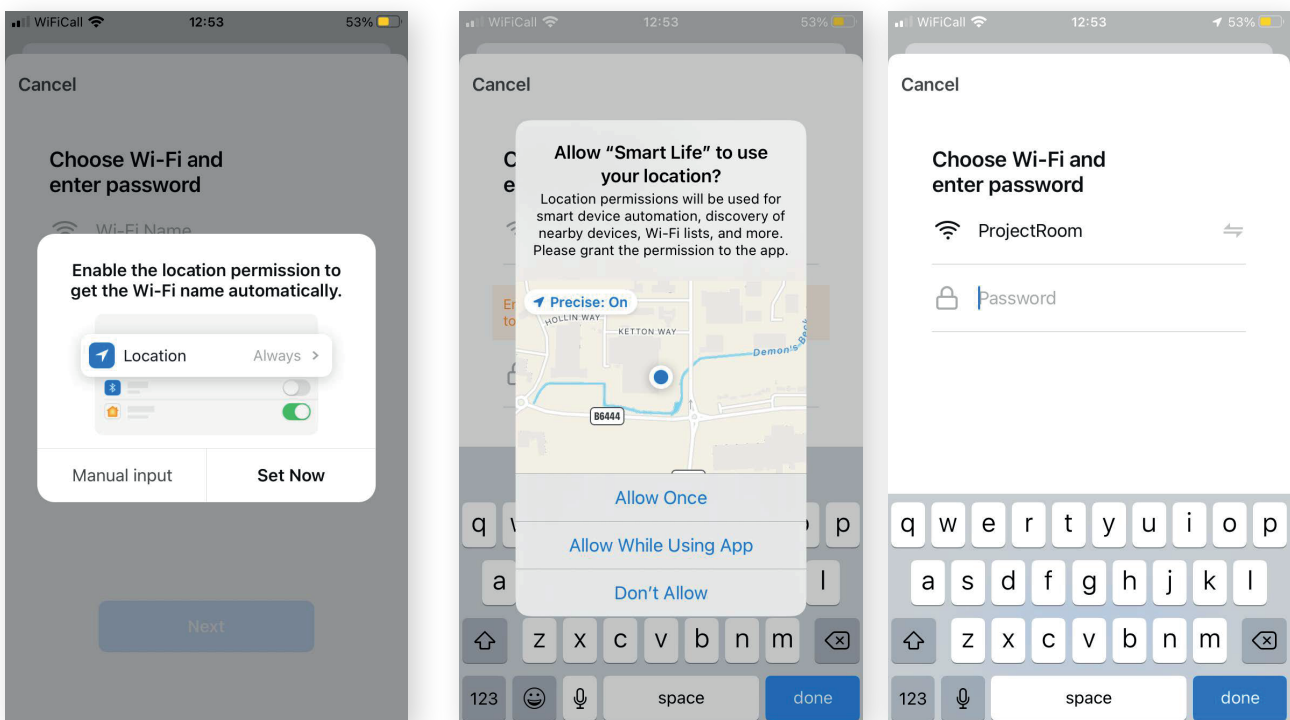

App Control

GETTING CONNECTED

6 Within 2 minutes the dehumidifier should be connected. Once connected you will have full access to the control interface.

If the dehumidifier fails to connect, turn off the dehumidifier for ten seconds and repeat the pairing process (step 4).

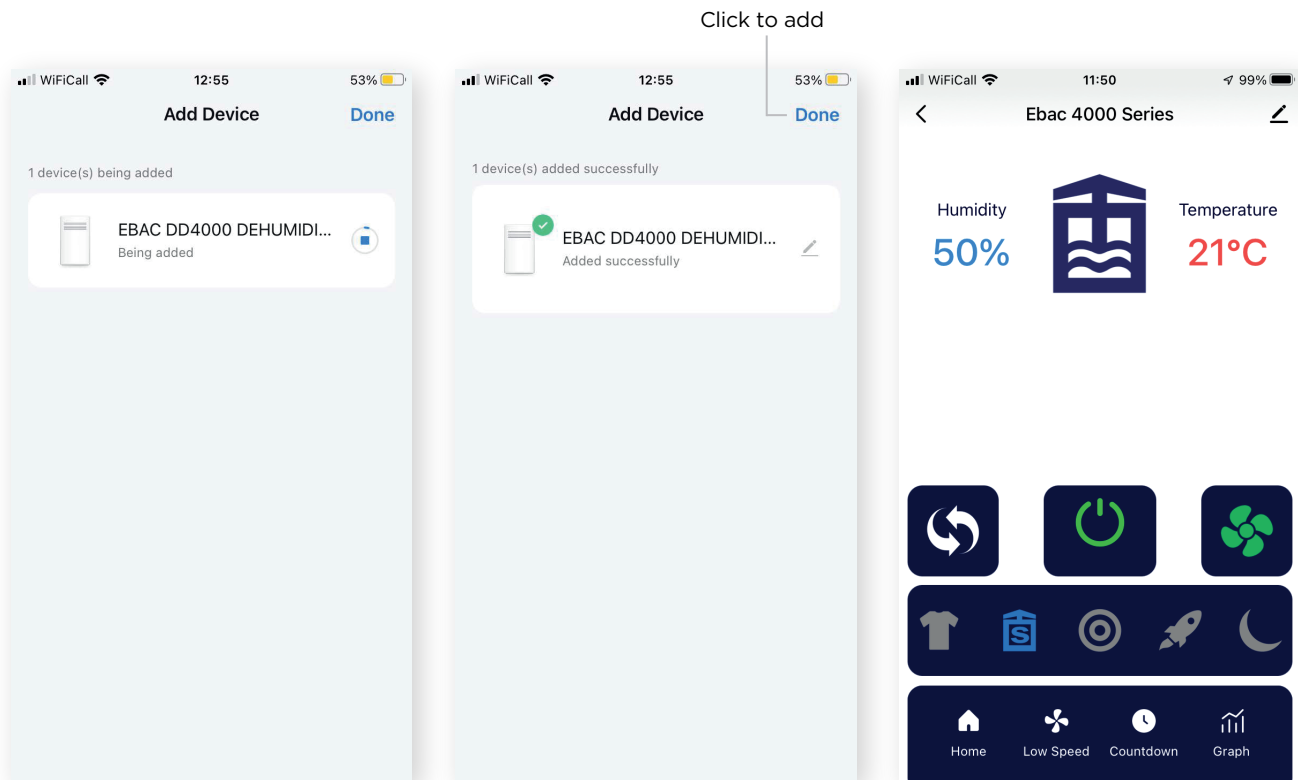

App control

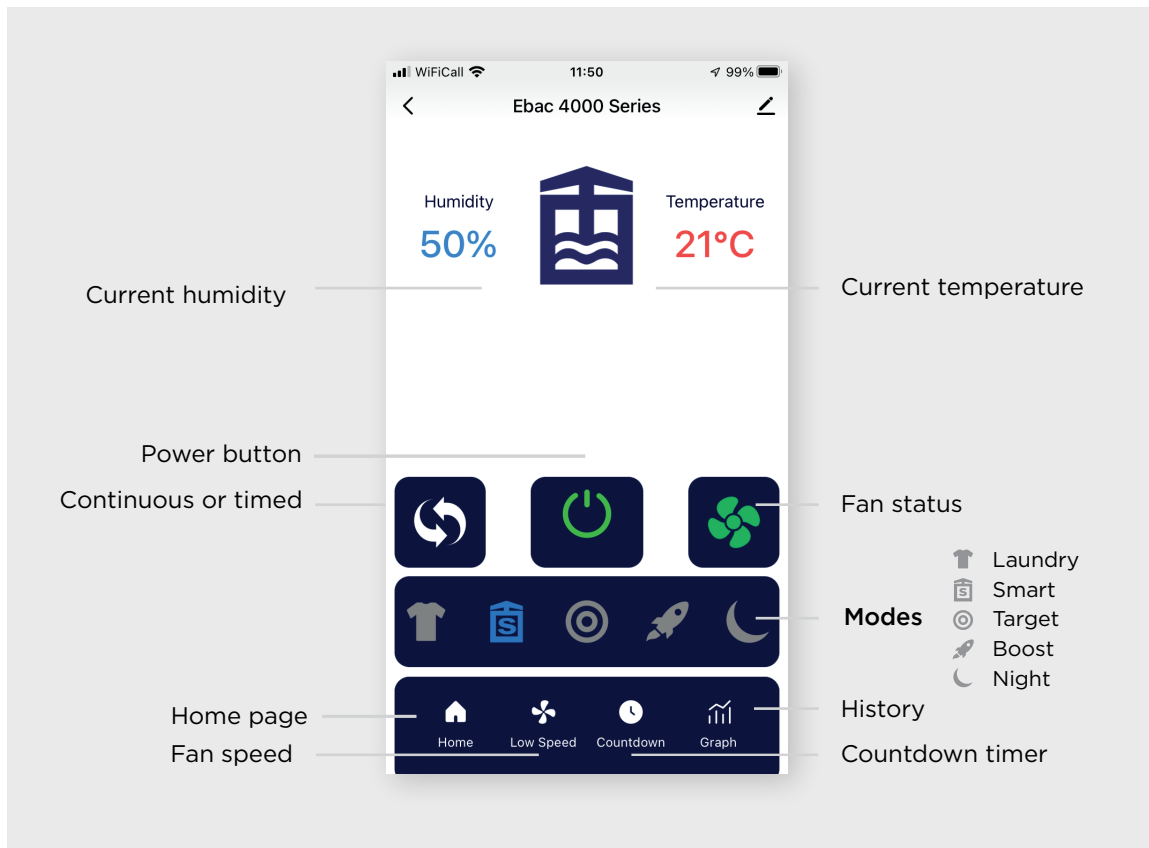

App troubleshooting and FAQ

The dehumidifier won't show during the pairing process

Check the following:

1. Did the App download successfully
2. Is your device (phone/tablet) connected to local Wi-Fi
3. Is the dehumidifier close to the Wi-Fi router, is it in range?
4. Is the dehumidifier switched on and working (does display show the green fan turning?)
5. Does the WiFi have a 2.4Ghz signal and is it available?

The dehumidifier shows during the pairing process but won't connect

If the dehumidifier shows up using the EZ pairing process but will not connect, AP pairing can be used to connect instead. Turn off the dehumidifier for 10 seconds then power on. Hold the power button for 4 seconds to enter EZ pairing mode (the WiFi icon flashes quickly). Press the power button again for 4 seconds to enter AP pairing mode (the WiFi icon flashes slowly). Open the app, select 'Add Device' when the dehumidifier shows up select add. Within 2 minutes the dehumidifier should be connected.

Smart Life FAQ's can be accessed by selecting the Me icon in the bottom right hand corner of the app.

Emptying the water container

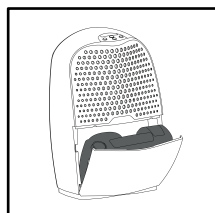

The red bucket icon on the control panel will illuminate when the container is full.

When this occurs, water collection stops.



The container can then be removed and emptied as shown. Replace the container back into the dehumidifier with the outlet on the left hand side and gently close the door.

Cleaning the Filter

Your Ebac 4000 has a filter to remove dust from the air.

This filter should be cleaned every month and replaced every 4 months. Failure to do this will reduce the performance of your dehumidifier and may over time lead to a permanent reduction in performance.

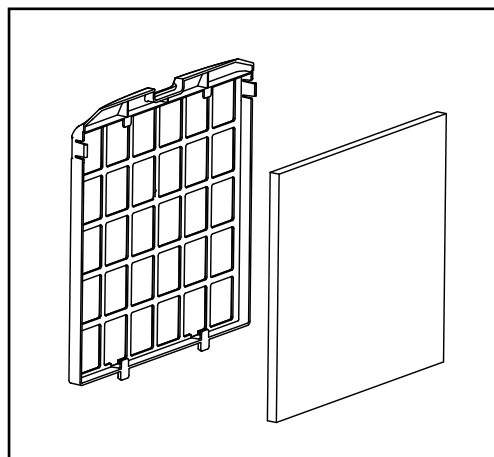
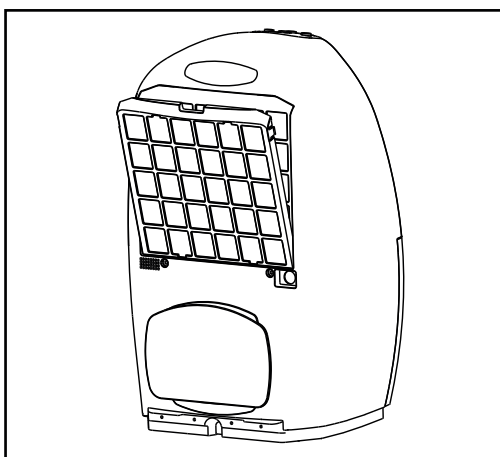

1. Remove the filter from the rear of the unit by pulling the filter housing outwards
2. Take the filter out of the housing and clean the filter using a vacuum cleaner with a soft furnishings attachment
3. Assemble the filter
4. Push the filter housing back on to the rear panel of the unit

Troubleshooting

<p>The unit has no power</p> <p>Are there any signs of power to the unit, is the display illuminated, is the fan blowing or Compressor running?</p>	<p>Is the unit plugged into a power supply?</p> <p>Is the mains supply working?</p> <p>Has the fuse been replaced?</p>	<p>Check someone hasn't disconnected the unit.</p> <p>Try another appliance in the socket, there may be no power from the socket.</p> <p>We suggest that you replace the fuse with the correct type for this model, if it continues to blow the fuse the unit is faulty</p>
--	--	---

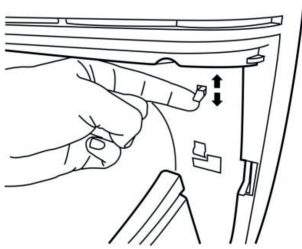
<p>There is a constant red light on the unit</p> <p>Is the display showing a red bucket icon constantly as if the water container is not present or is full?</p>  <p>Diagram A</p>	<p>Is the water container inserted and empty?</p> <p>Does the float inside the water container move freely?</p> <p>Is the micro-switch lever present?</p>	<p>Remove and replace the water container, ensuring it is inserted correctly – See Emptying the Water Container.</p> <p>Remove and empty any water from the water container. Now turn the container upside down and visually check that the float moves freely.</p> <p>Check the micro-switch lever (plastic lever located behind the bucket – See Diagram A) is present and working correctly. When you press this lever the fan should start up and the display should illuminate.</p>
--	---	--

<p>The unit is noisy</p> <p>Please bear in mind that there will always be a level of noise due to the fan & compressor, this will typically be louder than your fridge freezer.</p>	<p>Have you had the unit for a sufficient length of time?</p> <p>Is the unit positioned correctly?</p> <p>Is the unit excessively noisy?</p>	<p>It is normal for a new customer to think that the unit is noisy, within a week or 2 it will just become a background noise.</p> <p>If the unit is on wooden/laminated flooring this could make the unit sound louder, within a week or 2 it will just become a background noise.</p> <p>Some noise is normal due to the compressor and refrigeration circuit however if you believe the unit has become louder it may require a repair.</p>
--	--	--

Troubleshooting cont.

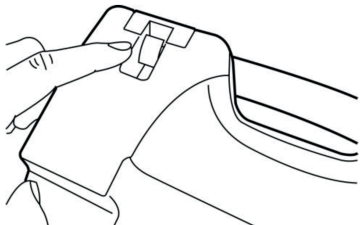
<p>The unit has a low water collection</p> <p>The unit is operating as normal but appears to be collecting less water.</p>	<p>Is the unit being run in target mode?</p> <p>Have you had the unit for a sufficient length of time?</p> <p>Have the weather conditions changed recently?</p>	<p>Target mode may not work if the target humidity is set too high try running the unit in SMART mode and see if the collection increases.</p> <p>As a new customer, you may feel that the collection of water has reduced after the initial installation, this is normal.</p> <p>If the weather is very cold / freezing there is less moisture in the air and the unit will collect less water.</p>
<p>The unit is not collecting any water</p> <p>The unit is operating as normal but is collecting NO water.</p>	<p>Has the unit been running for a reasonable period of time?</p> <p>Is the unit being operated close to a heat source?</p>	<p>24 hours should be sufficient time for you dehumidifier to collect water however we also suggest running the unit on the Maximum setting for 24 hours.</p> <p>Ensure the unit is placed in a suitable location – See Placing you dehumidifier for maximum performance.</p>
<p>The unit is overflowing</p> <p>The unit is operating as normal but is continuing to operate after the water container is full.</p>  <p><i>Diagram B</i></p>	<p>Does the unit continue to operate when the water container is not present?</p>	<p>Remove the water container from the unit. The red bucket icon should be illuminated and the compressor should not operate.</p>

Troubleshooting cont.

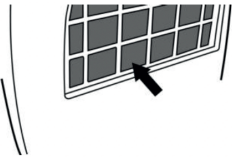
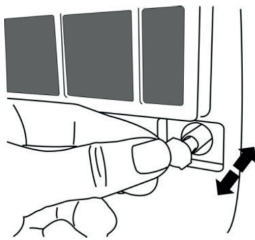
<p>The unit is icing up</p> <p>The unit is operating as normal but is creating a lot of ice at the rear of the unit.</p>  <p><i>Diagram C</i></p>	<p>Is there thick ice on the coil which does not disappear?</p> <p>Is the unit being run in the correct environment?</p>	<p>It is normal for a thin layer of ice or frost to form on the coil - See Diagram C, but this will disappear when the unit defrosts.</p> <p>The unit should be run in a domestic environment with an ambient temperature of 3°C or above?</p>
<p>The unit is leaking</p> <p>The unit is operating as normal but is leaking water.</p>  <p><i>Diagram D</i></p>	<p>Is the back of the unit leaking?</p> <p>Is the container leaking?</p> <p>Is the unit on a level surface?</p>	<p>Ensure that the drainage bung is inserted correctly in the rear of the unit - See Diagram D.</p> <p>Check that the container has no leaks by filling it with water over a sink.</p> <p>The unit may leak if it is not placed on a level surface. Your dehumidifier should always be placed on a level surface for this reason.</p>
<p>There is a problem with the display</p> <p>The unit appears to be operating as normal but the display is incorrect (Froze / No Fan Symbol etc)</p>	<p>Have you tried resetting the unit?</p>	<p>Unplug the unit and plug it back in. This will reset the unit and may resolve the problem.</p>
<p>The unit is damaged</p> <p>The unit has been delivered damaged or has become damaged since purchase.</p> <p>If the damaged part cannot be replaced we recommend you contact the customer service team on 0345 805 0000, who will advise the best course of action.</p>	<p>Can the damaged part be replaced?</p>	<p>If the Water Container / Filter Housing are damaged, we can supply a replacement without the need to return the unit to us.</p>

All information contained in this section can be found on our website and in the unlikely event of needing to return your dehumidifier for a repair, please go to:

www.ebac.com/support/customer-service

Alternatively call our customer service team on 0345 805 0000 during normal hours with the following information to hand:

- Dehumidifier serial number (located on a rating plate behind the water container)
- Your postcode and when and where you purchased your dehumidifier.

Warranty Registration

Thank you for purchasing an Ebac dehumidifier. If you have purchased directly with Ebac, your warranty has been automatically registered and active from day of purchase. If you have purchased an Ebac dehumidifier through one of our approved retailers - don't forget to register your unit online!

How to Register

Log on to www.ebac.com/support/warranty to register your Ebac dehumidifier warranty.

Why Register?

There are three reasons to register your Ebac dehumidifier:

- 1 You can take full advantage of your Ebac warranty.
 - Fast repair service carried out by Ebac with the unit collected and delivered from and to the place most convenient to you.
 - All parts and labour included.
 - 2 Your details are on record which enables us to help you much faster.
 - 3 You can choose to sign up to our mailing list to receive the latest product information and up to date offers.
-

What's Covered

- Your dehumidifier will receive unlimited repairs for any mechanical failure within the period of the warranty.
 - The costs associated with the collection, repair and return delivery of the dehumidifier.
 - The warranty covers dehumidifiers in domestic use in Great Britain and Northern Ireland.
 - Visit www.ebac.com/support/warranty for Terms and Conditions.
-

What's not Covered?

- The warranty does not cover wear and tear to the unit exterior or air filter.
- You may be charged if no fault is found or the fault is due to user error.
- The warranty does not cover accidental damage.

In the event of a breakdown, log on to www.ebac.com/support/faqs and use our quick and easy diagnostics system to resolve your problem without the need to speak to one of our Customer Service Team.

Alternatively call our customer service team on 0345 805 0000 during our normal hours.

This warranty does not affect your statutory rights as a purchaser.



Ketton Way, Aycliffe Business Park,
Newton Aycliffe, County Durham, DL5 6SQ,
United Kingdom

Tel: +44 (0)345 805 0000



Where you see this symbol on any of our electrical products or packaging, it indicates that the relevant electrical products should not be disposed of as general household waste in Europe. To ensure the correct waste treatment of the product, please dispose of it in accordance with any applicable local laws or requirements for disposal of electrical and electronic equipment in so doing, you will help to conserve natural resources and improve standards of environmental protection in treatment and disposal of electrical waste.